

COLOR TWO

RUS COLOR TWO - комплексное решение

Коллекция глазурованной плитки для внутреннего использования, цветовая гамма которой полностью идентичная теплым и холодным цветам плитки коллекции ColorONE. Кроме классических форматов 15x15 см, 20x20 см и 30x30 см в рамках данной серии также предлагается мозаика от 2,5x2,5 см до 10x10 см, все элементы коллекции в модульном исполнении. Модульные размеры позволяют комбинировать различные базовые элементы друг с другом, а также обеспечивают оптимальную совместимость с облицовочной плиткой серии ColorONE. Существенной составной частью серии ColorTWO является широкое предложение функциональных аксессуаров, которое позволяет осуществлять проекты любой технической сложности. Соответствие техническим требованиям обеспечивается благодаря специальным противоскользящим поверхностям, изготовленным в выбранных цветах и форматах, в том числе в формате 10x20 см, пользующимся большим спросом. При этом, несмотря на гарантированно высокое сопротивление скольжению некоторых поверхностей, плитку очень легко мыть. Изделия серии ColorTWO являются гарантией комплексного проектного решения.

COLOR TWO

HU COLOR TWO - teljeskörű megoldás

Mázás burkolólap család, amely színben megegyezik a ColorONE termékcsoporthoz "day and night" színválasztékával. A Hagyományosnak mondható 15x15 cm, 20x20 cm és 30x30 cm-es formátumok mellett a termékcsoporthoz mozaikokat is kínálunk 2,5x2,5 cm-től 10x10 cm-es méretig. Valamennyi termék modul méretben készül. A modul méret lehetővé teszi a különböző méretű termékek kombinációját, valamint biztosítja a ColorONE termékcsalád fal és padlóburkoló lapjaival való összeépíthetőséget is. A ColorTWO termékcsoporthoz egyik alapvető részét a széles kiegészítő elem választék, melyek segítségével bármilyen felület burkolása megoldható. Meghatározott színekben különleges csúszásmentes felületek is választhatóak, akár a népszerű 10x20 cm-es méretben is. A speciális csúszásmentes felületek nem rontják a burkolólapok tisztíthatóságát, karbantarthatóságát. A ColorTWO termékek teljeskörű megoldást kínálnak projektekre.

COLOR TWO

PL COLOR TWO - kompleksowe rozwiązanie

Uniwersalna seria szklonych płytek ceramicznych do stosowania we wnętrzach, jest kolorystycznie identyczna z dziennym i nocnym spektrum ściennych płytek ColorONE. Oferowana jest, obok klasycznych formatów 15x15 cm, 20x20 cm i 30x30 cm, w mozaikowych rozmiarach od 2,5x2,5 cm, do 10x10 cm, zawsze w rozmiarach modularnych. Modularność umożliwia wzajemne łączenie różnych wymiarów, a także osiągnięcie zgodności z płytkami ściennymi ColorONE. Ważnym elementem serii ColorTWO jest szeroka oferta kształtek specjalnych, pozwalająca wykonać okładzinę ceramiczną każdej powierzchni. Podwyższone wymagania techniczne spełniają specjalne płytki z przeciwpoślizgową powierzchnią, produkowane w wybranych kolorach i formatach, w tym w bardzo poszukiwanym formacie 10x20 cm. Gwarantowana przeciwpoślizgowość płytek w żaden sposób nie wpływa na łatwość utrzymania czystości. Produkty serii ColorTWO gwarantują kompleksowe rozwiązania projektowe.

COLOR TWO

CZ COLOR TWO - komplexní řešení

Ucelená série hutných glazovaných dlaždíc pro interiérové použití je identická s denním i nočním barevným spektrem obkládaček ColorONE. Formátová řada nabízí kromě klasického formátu 15x15 cm, 20x20 cm a 30x30 cm také mozaiky v rozměrech od 2,5x2,5 cm do 10x10 cm, vše v modulovém provedení. Modulové formáty umožňují vzájemnou kombinaci rozdílných základních prvků a také optimální dosažení kompatibility s obkládačkami série ColorONE. Podstatnou součástí série ColorTWO je široká nabídka funkčních doplňků, která dokáže vyřešit obložení každého prostoru. Náročné technické požadavky splňují speciální protiskluzné povrchy vyráběné ve vybraných barvách a formátech, včetně velmi žádaného formátu 10x20 cm. Garantovaná protiskluznost jednotlivých povrchů nijak neomezuje velmi dobrou čistitelnost. Výrobky série ColorTWO jsou zárukou komplexních projektových řešení.

COLOR TWO

ES COLOR TWO-SOLUCIÓN COMPLETA

Una serie completa de baldosas densas esmaltadas para uso en interiores. El espectro de colores es idéntico con la serie ColorONE. En formatos 15x15 cm, 20x20 cm y 30x30 cm y mosaicos en las dimensiones de 2,5x2,5 cm y 10x10 cm, todo en un diseño modular. Formatos modulares permiten combinación mutua de los diferentes elementos básicos, así como una compatibilidad óptima con la serie de azulejos ColorONE. Una parte sustancial de la serie ColorTWO es la gama de accesorios elementos técnicos funcionales que pueden resolver el revestimiento de cualquier espacio. Las normas técnicas más exigentes cumplen las superficies antideslizantes especiales fabricadas en colores y formatos seleccionados, incluido el formato más demandado de 10x20 cm. La función antideslizante garantizada no limita la limpieza. Productos de la serie ColorTWO son la garantía de soluciones completas para proyectos.

COLOR TWO

COLOR TWO

EN COLOR TWO - complex solution

Complete serie of glazed tiles for application in interiors is identical with both day and night colour spectrum of the ColorONE tiles. In addition to the standard format sized 15x15 cm, 20x20 cm and 30x30 cm the series also offers mosaic in sizes from 2,5x2,5 cm to 10x10 cm; all products are in modular version. These modular formats enable combination of differing basic elements and offer optimal compatibility with the wall and floor tiles of the ColorONE. A fundamental part of ColorTWO is the extensive offer of functional special pieces to resolve tiling of any space. Demanding technical requirements meet special slip-resistant surfaces made in selected colours and formats including the format sized 10x20cm that is in great demand. The guaranteed slip resistance of individual surfaces does not prevent easy maintenance of the products. Products of ColorTWO guarantee solutions of complex projects.

EN 14411-2012, annex H B1b GL				Wyrodek Product		Povrch Surface		Protiskliznost Slip resistance koefficient tření - za sucha		RAL 0304060	RAL 0506080	RAL 0607050	RAL 0858070	RAL 0908040	RAL 0958070	RAL 1208050	RAL 1306050		
cm	mm	cm	mm																
	2,5x2,5	23x23x6	mozaika set 30x30 cm	mosaic sheet 30x30 cm	mat matt	R10/B $\mu \geq 0,5$		GDM02150 ○ 96 m ²	GDM02142 ○ 96 m ²										
							lesk glossy												
	5x5	48x48x6	mozaika set 30x30 cm	mosaic sheet 30x30 cm	mat matt	R10/A $\mu \geq 0,5$		GDM05150 ○ 96 m ²	GDM05142 ○ 96 m ²										
							lesk glossy												
		48x48x7			mat matt	R10/B $\mu \geq 0,6$		GRS05650 ○ 118 m ²	GRS05642 ○ 118 m ²										
	10x10	98x98x6	dlaždice floor tile		mat matt	$\mu \geq 0,5$	GAA0K459 ○ 102 m ²	GAA0K150 ○ 90 m ²	GAA0K142 ○ 90 m ²								GAA0K466 ○ 88 m ²		
							lesk glossy	GAA0K359 ○ 102 m ²											
					mat matt	R10/B $\mu \geq 0,6$		GRS0K650 ○ 92 m ²	GRS0K642 ○ 92 m ²										
					mat matt	R10/B $\mu \geq 0,6$													
	10x20	98x198x7	dlaždice floor tile		mat matt	$\mu \geq 0,5$		GAAD8150 ○ 86 m ²	GAAD8142 ○ 86 m ²										
					mat matt	R10/B $\mu \geq 0,6$		GRND8150 ○ 88 m ²	GRND8142 ○ 88 m ²										
	15x15	148x148x7	dlaždice floor tile		mat matt	$\mu \geq 0,5$													
					mat matt	R10/B $\mu \geq 0,6$													
	20x20	198x198x7	dlaždice floor tile		mat matt	$\mu \geq 0,5$	GAA1K459 ○ 88 m ²	GAA1K460 ○ 84 m ²	GAA1K150 ○ 80 m ²	GAA1K142 ○ 80 m ²	GAA1K124 ○ 78 m ²	GAA1K464 ○ 80 m ²	GAA1K465 ○ 78 m ²	GAA1K466 ○ 80 m ²					
					mat matt	R10/B $\mu \geq 0,6$													
					mat matt	R10/B $\mu \geq 0,6$													
	30x30	298x298x8	dlaždice floor tile		mat matt	$\mu \geq 0,5$													

RAL 1907025	RAL 2408015	RAL 2606025	RAL 2902035	RAL 0001500	RAL 0004000	RAL 0805005	RAL 0607005	RAL 0008500	WHITE	RAL 0709010	RAL 0508010	RAL 0607020	RAL 0607010	RAL 0805010	RAL 0502010				
GDM02467 ○ 96 m ²	GDM02003 ○ 94 m ²		GDM02005 ○ 96 m ²				GDM02110 ○ 94 m ²	GDM02112 ○ 94 m ²	GDM02023 ○ 94 m ²	GDM02107 ○ 94 m ²	GDM02108 ○ 94 m ²								
									GDM02052 ○ 94 m ²										
GDM05467 ○ 96 m ²	GDM05003 ○ 94 m ²		GDM05005 ○ 96 m ²				GDM05110 ○ 94 m ²	GDM05112 ○ 94 m ²	GDM05023 ○ 94 m ²	GDM05107 ○ 94 m ²	GDM05108 ○ 94 m ²								
									GDM05052 ○ 94 m ²										
GRS05667 ○ 118 m ²	GRS05603 ○ 118 m ²		GRS05605 ○ 118 m ²				GRS05610 ○ 118 m ²	GRS05612 ○ 118 m ²	GRS05623 ○ 118 m ²	GRS05607 ○ 118 m ²	GRS05608 ○ 118 m ²								
GAA0K467 ○ 88 m ²	GAA0K003 ○ 86 m ²		GAA0K555 ○ 92 m ²	GAA0K048 ○ 90 m ²	GAA0K248 ○ 90 m ²	GAA0K111 ○ 88 m ²	GAA0K110 ○ 86 m ²	GAA0K112 ○ 86 m ²	GAA0K023 ○ 84 m ²	GAA0K107 ○ 86 m ²	GAA0K108 ○ 86 m ²	GAA0K311 ○ 88 m ²	GAA0K312 ○ 90 m ²	GAA0K313 ○ 92 m ²					
				GAA0K548 ○ 90 m ²					GAA0K052 ○ 84 m ²										
GRS0K667 ○ 90 m ²	GRS0K603 ○ 88 m ²		GRS0K605 ○ 94 m ²		GRS0K248 ○ 92 m ²		GRS0K610 ○ 88 m ²	GRS0K612 ○ 88 m ²	GRS0K623 ○ 86 m ²	GRS0K607 ○ 88 m ²	GRS0K608 ○ 88 m ²								
					GAF0K248 ○ 92 m ²		GAF0K610 ○ 88 m ²	GAF0K612 ○ 88 m ²	GAF0K023 ○ 86 m ²										
GAAD8467 ○ 86 m ²	GAAD8003 ○ 82 m ²		GAAD8005 ○ 86 m ²				GAAD8110 ○ 82 m ²		GAAD8023 ○ 80 m ²		GAAD8108 ○ 82 m ²								
GRND8467 ○ 88 m ²	GRND8003 ○ 84 m ²		GRND8005 ○ 88 m ²				GRND8110 ○ 84 m ²		GRND8023 ○ 82 m ²		GRND8108 ○ 84 m ²								
							GAA17110 ○ 78 m ²		GAA17023 ○ 76 m ²		GAA17108 ○ 80 m ²								
									GRS17623 ○ 78 m ²										
GAA1K467 ○ 80 m ²	GAA1K003 ○ 76 m ²	GAA1K127 ○ 78 m ²	GAA1K555 ○ 80 m ²	GAA1K048 ○ 80 m ²	GAA1K248 ○ 80 m ²	GAA1K111 ○ 80 m ²	GAA1K110 ○ 76 m ²	GAA1K112 ○ 76 m ²	GAA1K023 ○ 74 m ²	GAA1K107 ○ 76 m ²	GAA1K108 ○ 76 m ²	GAA1K311 ○ 80 m ²	GAA1K312 ○ 80 m ²	GAA1K313 ○ 82 m ²	GAA1K671 ○ 82 m ²				
									GRS1K603 ○ 78 m ²		GRS1K605 ○ 82 m ²		GRS1K248 ○ 82 m ²		GRS1K610 ○ 78 m ²	GRS1K612 ○ 78 m ²	GRS1K623 ○ 76 m ²	GRS1K607 ○ 78 m ²	GRS1K608 ○ 78 m ²
							GAF1K248 ○ 82 m ²		GAF1K610 ○ 78 m ²	GAF1K612 ○ 78 m ²	GAF1K023 ○ 76 m ²								
									GAA2J110 ○ 78 m ²	GAA2J112 ○ 78 m ²	GAA2J023 ○ 76 m ²	GAA2J107 ○ 78 m ²	GAA2J108 ○ 78 m ²						

STO č. 030 - 049916																			
cm		mm		Wyrohek Product	Povrch Surface	Protiskliznost Slip resistance koeficient tření - za sucha	RAL	RAL	RAL	RAL	RAL	RAL	RAL	RAL	RAL	RAL	RAL	RAL	
L	B	L	B				0304060	0506080	0607050	0858070	0908040	0958070	1208050	1306050					
	10x10	98x98x6	bezbariérová tvárovka rohová	shower piece corner	mat matt	R10/B $\mu \geq 0,6$													
	10x10	98x98x6	bezbariérová tvárovka průběžná	shower piece continuous	mat matt	R10/B $\mu \geq 0,6$													
	10x10	98x103x6	sokl s požlábkem	cove skirting	mat matt														
	10x10	98x103x6	sokl s požlábkem	cove skirting	mat matt	R10/B $\mu \geq 0,6$													
	2,4x10	24x103x6	sokl vnitřní roh	cove skirting inside corner	mat matt														
	3x10	30x103x6	sokl vnější roh	cove skirting outside corner	mat matt														
	2,4x10	24x98x6	hrana vnitřní	inside edge	mat matt														
	2,4x10	24x98x6	hrana vnější	outside edge	mat matt														
	2,4x2,4	24x24x24	vnější roh	outside corner	mat matt														
	20x20	198x204x7 news	sokl s požlábkem	cove skirting	mat matt														
	20x20	198x204x7 news	sokl s požlábkem	cove skirting	mat matt	R10/B $\mu \geq 0,6$													
	2,4x20	24x204x7 news	sokl vnitřní roh	cove skirting inside corner	mat matt														
	3x20	30x204x7 news	sokl vnější roh	cove skirting outside corner	mat matt														
	2,4x20	24x198x7 news	hrana vnitřní	inside edge	mat matt														
	2,4x20	24x198x7 news	hrana vnější	outside edge	mat matt														

* K dispozici od 4/2016. | Available from 4/2016. | Dostępny w 4/2016. | K отпуску с 4/2016. | Áprilistól elerhető 2016. | Disponible desde 4/2016.

RAL	RAL	RAL	RAL	RAL	RAL	RAL	RAL	RAL	RAL	RAL	RAL	RAL	RAL	RAL	RAL	RAL	RAL	RAL	
1907025	2408015	2606025	2902035	0001500	0004000	0805005	0607005	0008500	WHITE	0709010	0508010	0607020	0607010	0805010	0502010				
			GTRON605 ○ 54 ks	GTRON248 ○ 54 ks	GTRON610 ○ 54 ks	GTRON612 ○ 54 ks	GTRON623 ○ 54 ks	GTRON607 ○ 54 ks	GTRON608 ○ 54 ks										
			GTPON605 ○ 54 ks	GTPON248 ○ 54 ks	GTPON610 ○ 54 ks	GTPON612 ○ 54 ks	GTPON623 ○ 54 ks	GTPON607 ○ 54 ks	GTPON608 ○ 54 ks										
	GSPJ003 ○ 34 ks	GSPJ005 ○ 34 ks	GSPJ248 ○ 34 ks	GSPJ110 ○ 34 ks	GSPJ112 ○ 34 ks	GSPJ023 ○ 34 ks	GSPJ107 ○ 34 ks	GSPJ108 ○ 34 ks											
		GSTON605 ○ 38 ks	GSTON248 ○ 38 ks	GSTON610 ○ 38 ks	GSTON612 ○ 38 ks	GSTON623 ○ 38 ks	GSTON607 ○ 38 ks	GSTON608 ○ 38 ks											
	GSIRC003 ○ 50 ks	GSIRC005 ○ 50 ks	GSIRC248 ○ 50 ks	GSIRC110 ○ 50 ks	GSIRC112 ○ 50 ks	GSIRC023 ○ 50 ks	GSIRC107 ○ 50 ks	GSIRC108 ○ 50 ks											
	GSERC003 ○ 50 ks	GSERC005 ○ 50 ks	GSERC248 ○ 50 ks	GSERC110 ○ 50 ks	GSERC112 ○ 50 ks	GSERC023 ○ 50 ks	GSERC107 ○ 50 ks	GSERC108 ○ 50 ks											
	GSIA5003 ○ 50 ks	GSIA5005 ○ 50 ks	GSIA5248 ○ 50 ks	GSIA5110 ○ 50 ks	GSIA5112 ○ 50 ks	GSIA5023 ○ 50 ks	GSIA5107 ○ 50 ks	GSIA5108 ○ 50 ks											
	GSEA5003 ○ 50 ks	GSEA5005 ○ 50 ks	GSEA5248 ○ 50 ks	GSEA5110 ○ 50 ks	GSEA5112 ○ 50 ks	GSEA5023 ○ 50 ks	GSEA5107 ○ 50 ks	GSEA5108 ○ 50 ks											
	GTVR4003 ○ 58 ks	GTVR4005 ○ 58 ks	GTVR4248 ○ 58 ks	GTVR4110 ○ 58 ks	GTVR4112 ○ 58 ks	GTVR4023 ○ 58 ks	GTVR4107 ○ 58 ks	GTVR4108 ○ 58 ks											
	GSP1K003° ○ 44 ks	GSP1K005° ○ 44 ks	GSP1K248° ○ 44 ks	GSP1K110° ○ 44 ks	GSP1K112° ○ 44 ks	GSP1K023° ○ 44 ks	GSP1K107° ○ 44 ks	GSP1K108° ○ 44 ks											
	GST1K003° ○ 48 ks	GST1K005° ○ 48 ks	GST1K248° ○ 48 ks	GST1K110° ○ 48 ks	GST1K112° ○ 48 ks	GST1K023° ○ 48 ks	GST1K107° ○ 48 ks	GST1K108° ○ 48 ks											
	GSIRI003° ○ 54 ks	GSIRI005° ○ 54 ks	GSIRI248° ○ 54 ks	GSIRI110° ○ 54 ks	GSIRI112° ○ 54 ks	GSIRI023° ○ 54 ks	GSIRI107° ○ 54 ks	GSIRI108° ○ 54 ks											
	GSERI003° ○ 54 ks	GSERI005° ○ 54 ks	GSERI248° ○ 54 ks	GSERI110° ○ 54 ks	GSERI112° ○ 54 ks	GSERI023° ○ 54 ks	GSERI107° ○ 54 ks	GSERI108° ○ 54 ks											
	GSIAP003° ○ 54 ks	GSIAP005° ○ 54 ks	GSIAP248° ○ 54 ks	GSIAP110° ○ 54 ks	GSIAP112° ○ 54 ks	GSIAP023° ○ 54 ks	GSIAP107° ○ 54 ks	GSIAP108° ○ 54 ks											
	GSEAP003° ○ 54 ks	GSEAP005° ○ 54 ks	GSEAP248° ○ 54 ks	GSEAP110° ○ 54 ks	GSEAP112° ○ 54 ks	GSEAP023° ○ 54 ks	GSEAP107° ○ 54 ks	GSEAP108° ○ 54 ks											



20x20
GAA1K459
μ ≥ 0,5



RAL 0304060 PEI 2

10x10
GAA0K459
μ ≥ 0,5

20x20
GAA1K460
μ ≥ 0,5



RAL 0506080 PEI 3

10x20
GAA08150
μ ≥ 0,5

2,5x2,5
GDM02150
R10 B μ ≥ 0,5

20x20
GAA1K150
μ ≥ 0,5



RAL 0607050 PEI 3

5x5
GDM05150
R10 A μ ≥ 0,5

10x10
GAA0K150
μ ≥ 0,5

10x20
GRN08150
R10 B μ ≥ 0,6

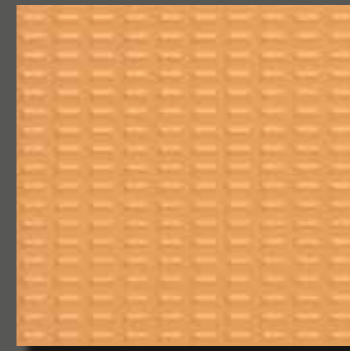

RAL 0607050 PEI 3

10x20
GAA08142
μ ≥ 0,5

2,5x2,5
GDM02142
R10 B μ ≥ 0,5

20x20
GAA1K142
μ ≥ 0,5



RAL 0858070 PEI 3

5x5
GDM05142
R10 A μ ≥ 0,5

10x10
GAA0K142
μ ≥ 0,5

10x20
GRN08142
R10 B μ ≥ 0,6

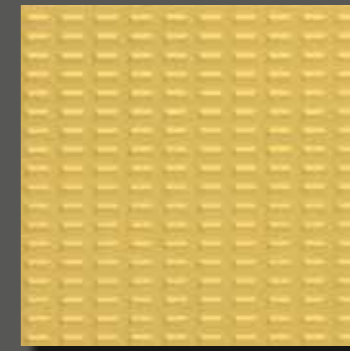

RAL 0858070 PEI 3



RAL 0304060 PEI 2

10x10
GAA0K359



RAL 0607050 PEI 3

10x10
GRS0K650
R10 B μ ≥ 0,6

5x5
GRS05650
R10 B μ ≥ 0,6



RAL 0858070 PEI 3

10x10
GRS0K642
R10 B μ ≥ 0,6

5x5
GRS05642
R10 B μ ≥ 0,6

Barevné odstíny a RAL kódy, které jsou zde vyobrazeny, mají pouze orientační charakter. | The colours correspond to RAL and the shades shown are for orientation only. | Prezentowane kolory płytek a RAL kody są orientacyjne. | Цвобразженніе оттенки цветов а RAL коды имеют лишь ориентационный характер. | A megjelenített árnyalatok és RAL minták csak tájékoztató jellegűek. | Los tonos de colores RAL y los códigos que se muestran aquí, son sólo indicativos.



20x20
GAA1K124
μ ≥ 0,5

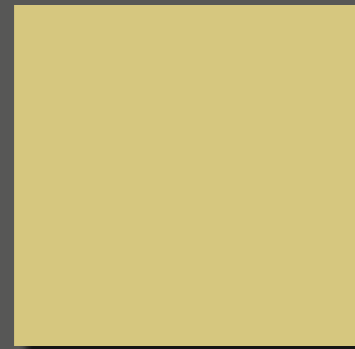

RAL 0908040 PEI 4

20x20
GAA1K464
μ ≥ 0,5



RAL 0958070 PEI 4

20x20
GAA1K465
μ ≥ 0,5



RAL 1208050 PEI 4

20x20
GAA1K466
μ ≥ 0,5



RAL 1306050 PEI 3

10x10
GAA0K466
μ ≥ 0,5



10x20
GAA0B467
μ ≥ 0,5



GDM02467
R10 B μ ≥ 0,5

20x20
GAA1K467
μ ≥ 0,5



RAL 1907025 PEI 3

10x20
GRN0B467
R10 B μ ≥ 0,6

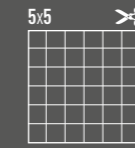

GDM05467
R10 A μ ≥ 0,5

10x10
GAA0K467
μ ≥ 0,5

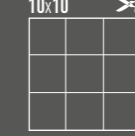

RAL 1907025 PEI 3



RAL 1907025 PEI 3

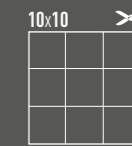

GRS0K667
R10 B μ ≥ 0,6

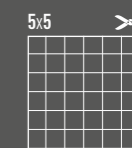

GRS0S667
R10 B μ ≥ 0,6

10x20

GAA08003
μ ≥ 0,5

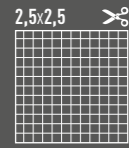

GDM02003
R10 B μ ≥ 0,5

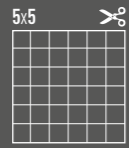

GDM05003
R10 A μ ≥ 0,5

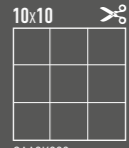

GAA0K003
μ ≥ 0,5

20x20

GAA1K003
μ ≥ 0,5

10x20

GRND8003
R10 B μ ≥ 0,6

10x20

GAA08005
μ ≥ 0,5

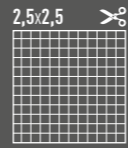

GDM02005
R10 B μ ≥ 0,5

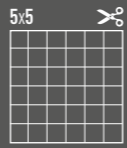

GDM05005
R10 A μ ≥ 0,5

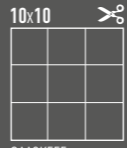

GAA0K555
μ ≥ 0,5

10x20

GRND8005
R10 B μ ≥ 0,6

20x20

GAA1K555
μ ≥ 0,5

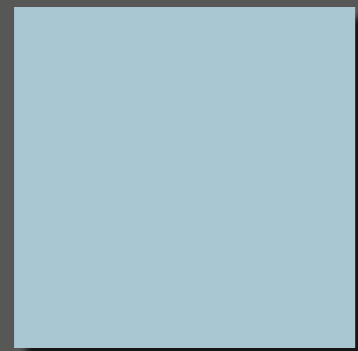

RAL 2408015 PEI 4

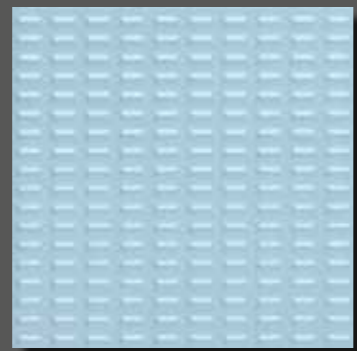

RAL 2408015 PEI 4

20x20

GAA1K127
μ ≥ 0,5

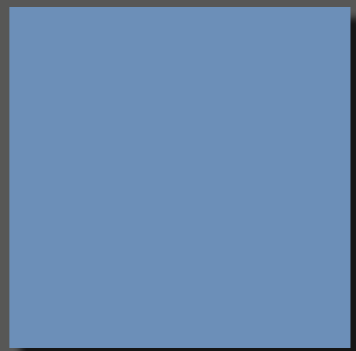

RAL 2606025 PEI 4



RAL 2902035 PEI 3

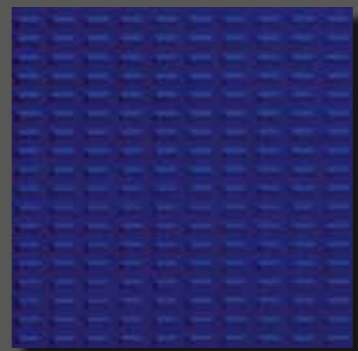

RAL 2902035 PEI 3

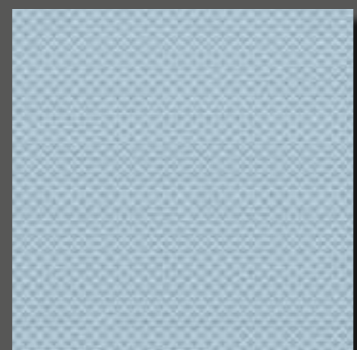

RAL 2408015 PEI 4



RAL 2902035 PEI 3

20x20

GRS1K603
R10 B μ ≥ 0,6

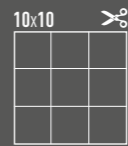

GRS0K603
R10 B μ ≥ 0,6

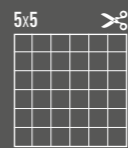

GRS05603
R10 B μ ≥ 0,6

20x20

GRS1K605
R10 B μ ≥ 0,6

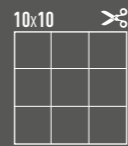



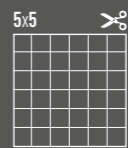





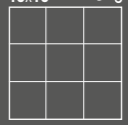

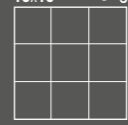

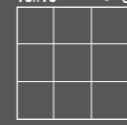







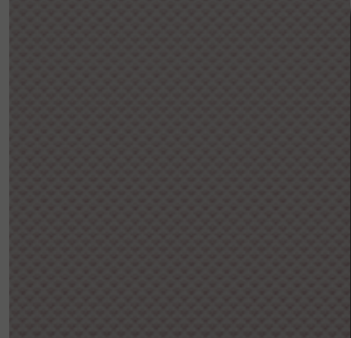

GRS0K605
R10 B μ ≥ 0,6

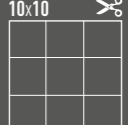

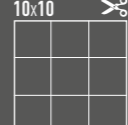
GRS05605
R10 B μ ≥ 0,6

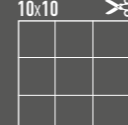

<p>20x20 GAA1K048 μ ≥ 0,5</p>  <p>RAL 0001500</p>	<p>10x10 GAA0K048 μ ≥ 0,5</p>  <p>PEI 2</p>	<p>20x20 GAA1K248 μ ≥ 0,5</p>  <p>RAL 0004000</p>	<p>10x10 GAA0K248 μ ≥ 0,5</p>  <p>PEI 2</p>	<p>20x20 GAA1K111 μ ≥ 0,5</p>  <p>RAL 0805005</p>	<p>10x10 GAA0K111 μ ≥ 0,5</p>  <p>PEI 3</p>	<p>20x20 GAA1K110 μ ≥ 0,5</p>  <p>RAL 0607005</p>	<p>10x10 GAA0K110 μ ≥ 0,5</p>  <p>PEI 4</p>	<p>10x20 GRND8110 R10 B μ ≥ 0,6</p>  <p>RAL 0607005</p>	<p>10x20 GRND8110 R10 B μ ≥ 0,6</p>  <p>PEI 4</p>
---	--	---	--	---	--	---	--	---	--

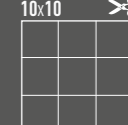
<p>RAL 0001500</p>  <p>PEI 2</p>	<p>RAL 0004000</p>  <p>PEI 2</p>	<p>RAL 0004000</p>  <p>PEI 2</p>	<p>RAL 0607005</p>  <p>PEI 4</p>	<p>RAL 0607005</p>  <p>PEI 4</p>					
<p>10x10 GAA0K548</p> 	<p>20x20 GRS1K248 R10 B μ ≥ 0,6</p> 	<p>10x10 GRS0K248 R10 B μ ≥ 0,6</p> 	<p>20x20 GAF1K248 R10 B μ ≥ 0,6</p> 	<p>10x10 GAF0K248 R10 B μ ≥ 0,6</p> 	<p>20x20 GRS1K610 R10 B μ ≥ 0,6</p> 	<p>10x10 GRS0K610 R10 B μ ≥ 0,6</p> 	<p>5x5 GRS0S610 R10 B μ ≥ 0,6</p> 	<p>20x20 GAF1K610 R10 B μ ≥ 0,6</p> 	<p>10x10 GAF0K610 R10 B μ ≥ 0,6</p> 

Barevné odstíny a RAL kódy, které jsou zde vyobrazeny, mají pouze orientační charakter. | The colours correspond to RAL and the shades shown are for orientation only. | Prezentowane kolory płytek a RAL kody są orientacyjne. | Цвoбpажeнныe oттeнки цвeтoв a RAL кoды имeют лишь oриeнтaциoнный xapaктep. | A megjelenített árnyalatok és RAL minták csak tájékoztató jellegűek. | Los tonos de colores RAL y los códigos que se muestran aquí, son sólo indicativos.

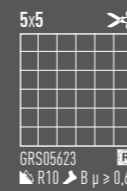
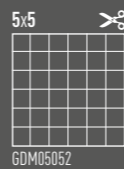
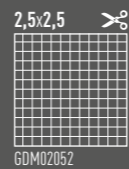
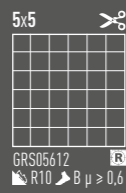
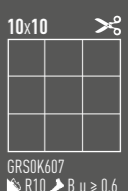
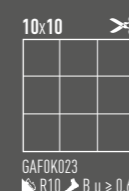
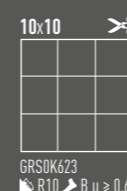
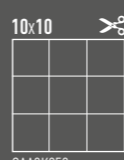
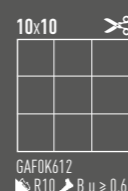
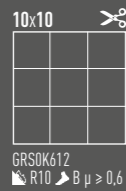
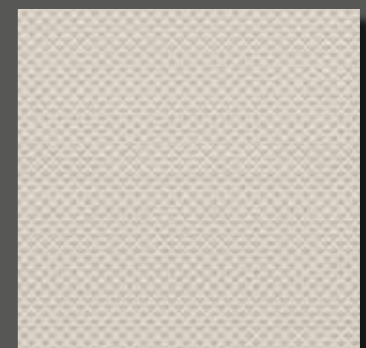
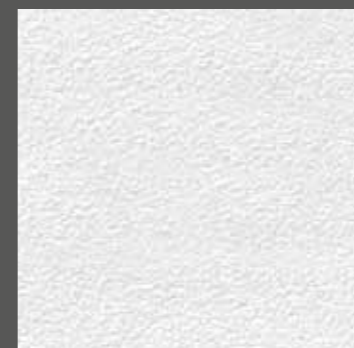
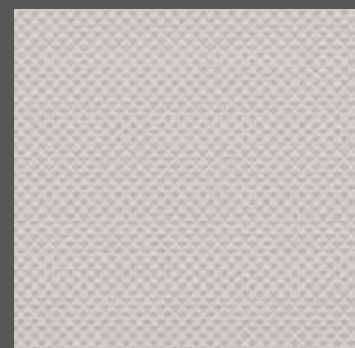
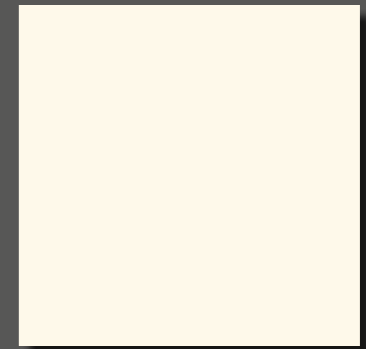
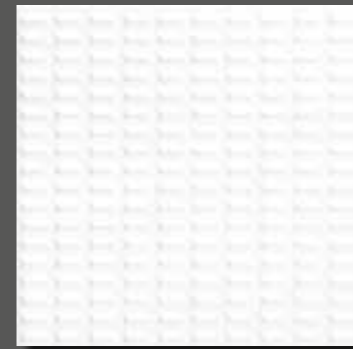
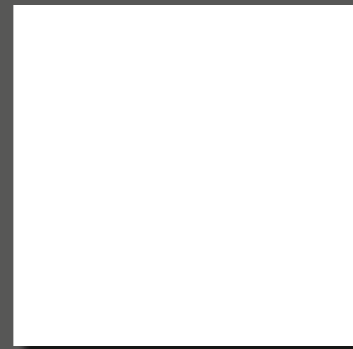
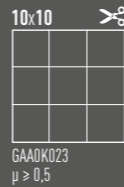
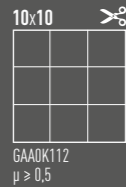
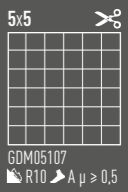
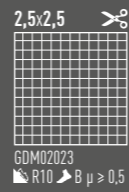
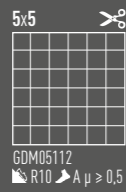
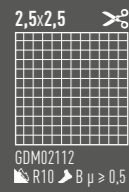

Barevné odstíny a RAL kódy, které jsou zde vyobrazeny, mají pouze orientační charakter. | The colours correspond to RAL and the shades shown are for orientation only. | Prezentowane kolory płytek a RAL kody są orientacyjne. | Цвoбpaжeннe oттeнки цвeтoв a RAL кoды имeют лишь oриeнтaциoнный xapaктep. | A megjelenített árnyalatok és RAL minták csak tájékoztató jellegűek. | Los tonos de colores RAL y los códigos que se muestran aquí, son sólo indicativos.

15x15

GAA17108
μ ≥ 0,5

10x20

GAA08108
μ ≥ 0,5

2,5x2,5

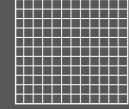

GDM02108
R10 B μ ≥ 0,5

30x30

GAA21108
μ ≥ 0,5

5x5

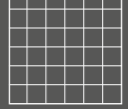

GDM05108
R10 A μ ≥ 0,5

10x20

GRN08108
R10 B μ ≥ 0,6

20x20

GAA1K108
μ ≥ 0,5

10x10

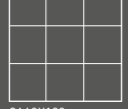

GAA0K108
μ ≥ 0,5

20x20

GAA1K311
μ ≥ 0,5

10x10

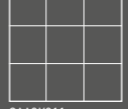

GAA0K311
μ ≥ 0,5

20x20

GAA1K312
μ ≥ 0,5

10x10

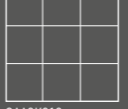

GAA0K312
μ ≥ 0,5

20x20

GAA1K313
μ ≥ 0,5

10x10

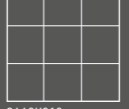

GAA0K313
μ ≥ 0,5

20x20

GAA1K671
μ ≥ 0,5

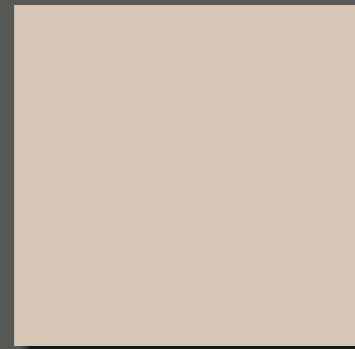

RAL 0508010

PEI 4



RAL 0508010

PEI 4



RAL 0607020

PEI 3



RAL 0607010

PEI 3



RAL 0805010

PEI 3

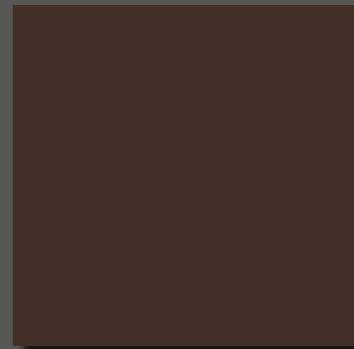

RAL 0502010

PEI 2

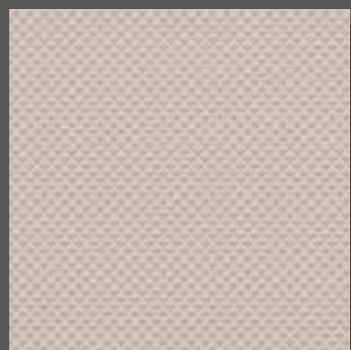

RAL 0508010

PEI 4

20x20

GRS1K608
R10 B μ ≥ 0,6

10x10

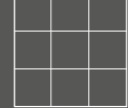

GRS0K608
R10 B μ ≥ 0,6

5x5

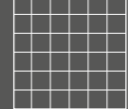

GRS05608
R10 B μ ≥ 0,6

sokl s požlábkem | **GSP1K...** | 198x204x7 mm
 cove skirting | **GSP1K...** | 198x204x7 mm

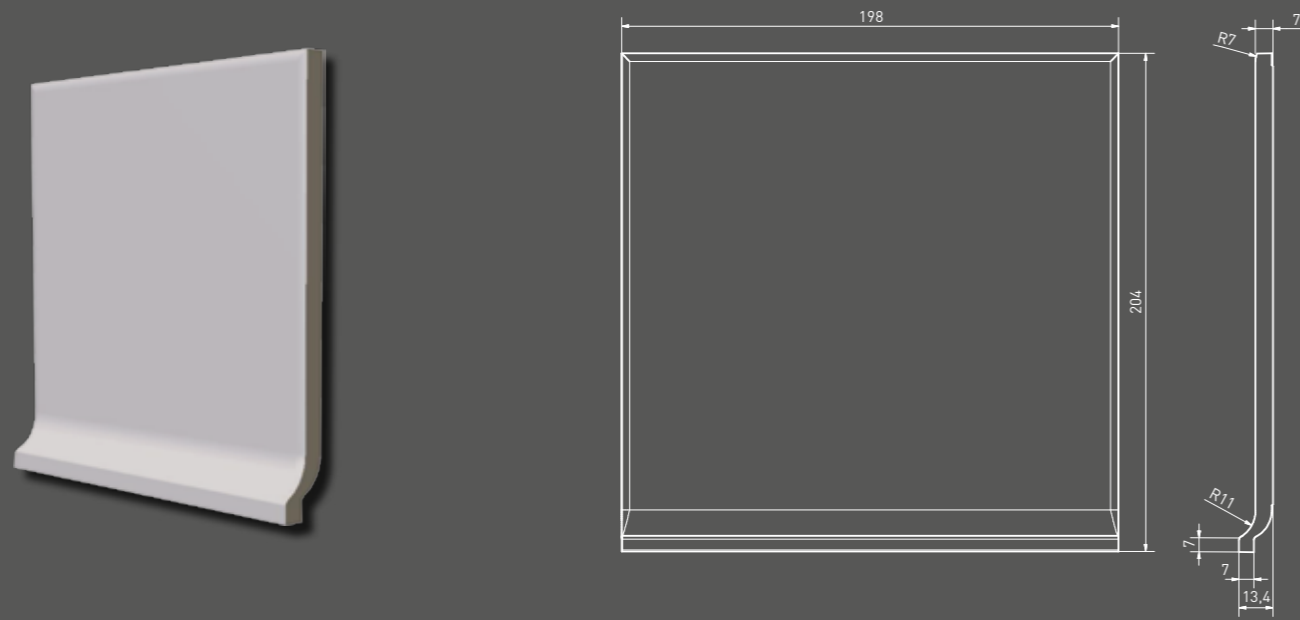

sokl vnitřní roh | **GSIRI...** | 24x204x7 mm
 cove skirting inside corner | **GSIRI...** | 24x204x7 mm

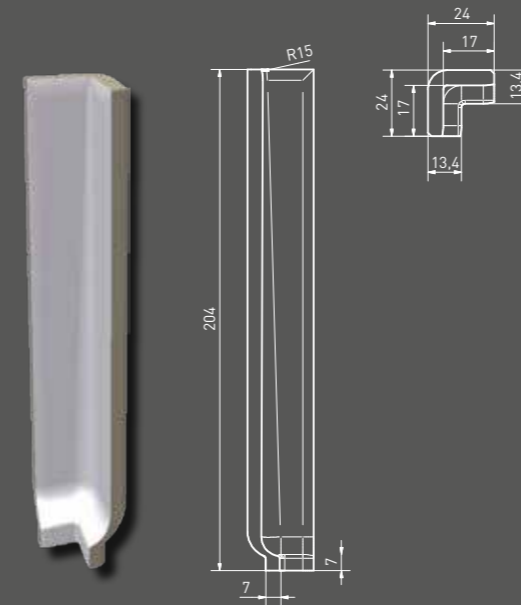

sokl vnější roh | **GSERI...** | 30x204x7 mm
 cove skirting outside corner | **GSERI...** | 30x204x7 mm

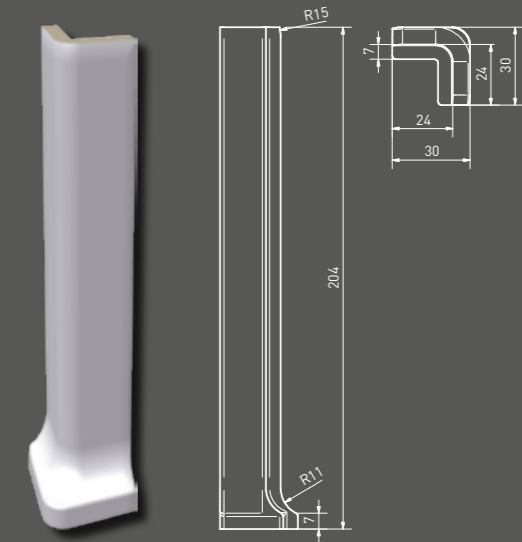

sokl s požlábkem | **GST1K...** | 198x204x7 mm
 cove skirting | **GST1K...** | 198x204x7 mm

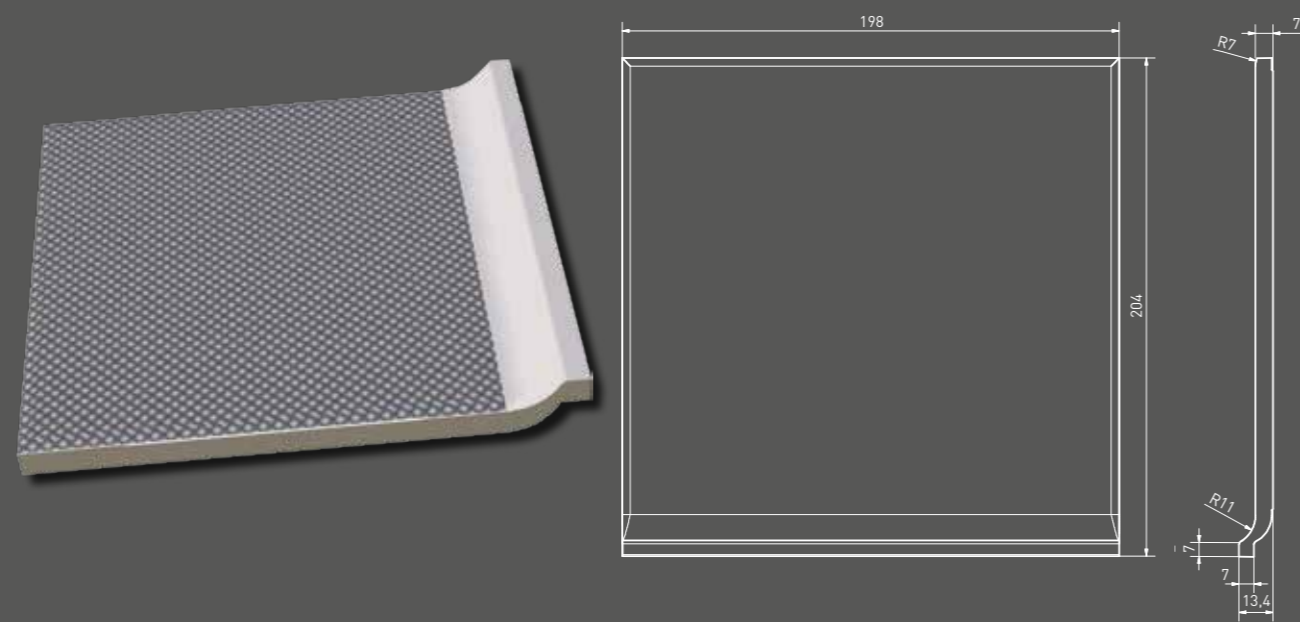

průběžná hrana vnitřní | **GSIAF...** | 24x198x7 mm
 shower piece - inside edge | **GSIAF...** | 24x198x7 mm

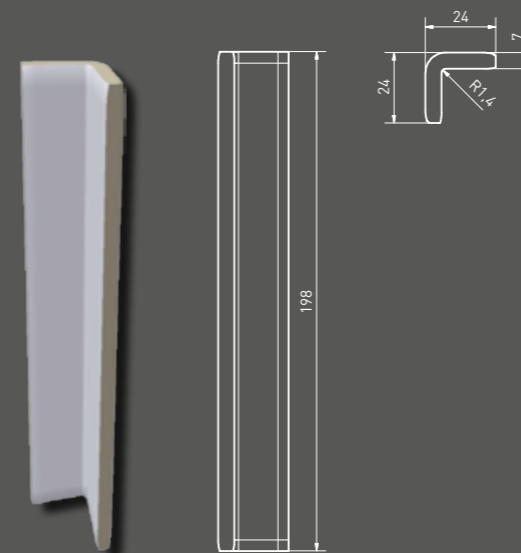

průběžná hrana vnější | **GSEAF...** | 24x198x7 mm
 shower piece - outside edge | **GSEAF...** | 24x198x7 mm

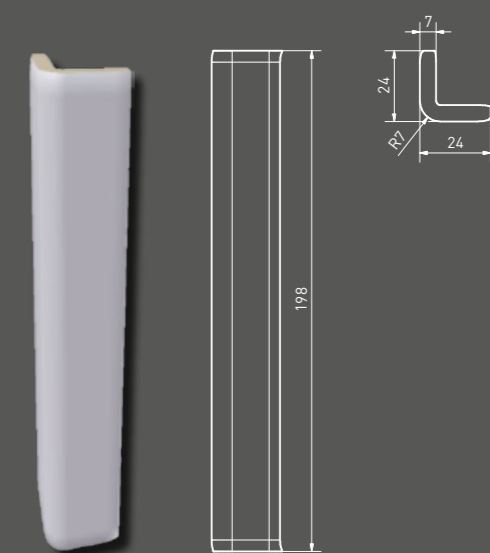

bezbariérová tvarovka rohová | **GTRON...** | 98x98x6 mm
 shower piece - corner | **GTRON...** | 98x98x6 mm

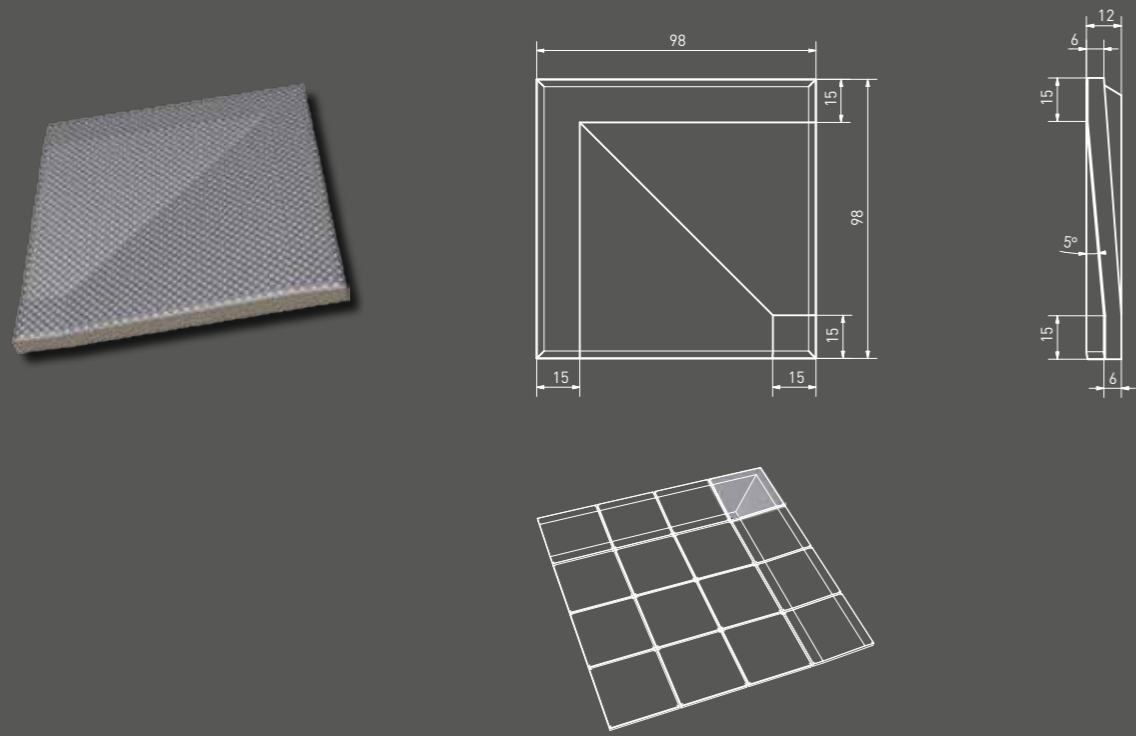

sokl s požlábkem | **GSPDJ...** | 98x103x6 mm
 cove skirting | **GSPDJ...** | 98x103x6 mm

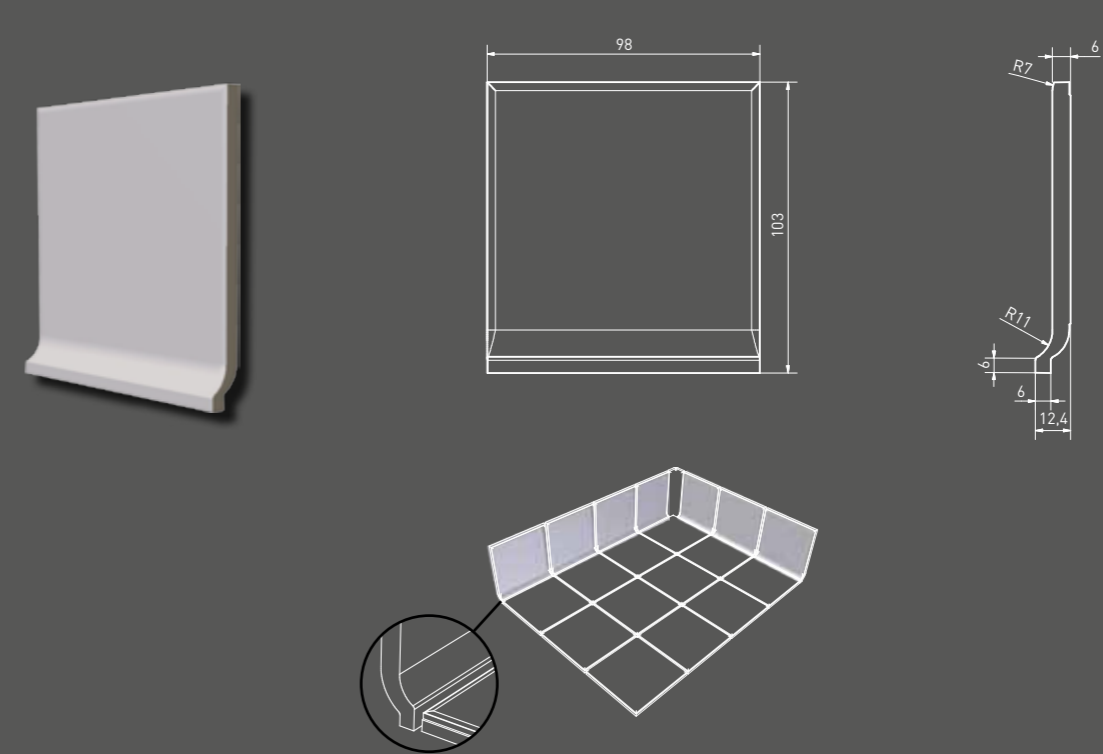

bezbariérová tvarovka průběžná | **GTPON...** | 98x98x6 mm
 shower piece - continuous | **GTPON...** | 98x98x6 mm

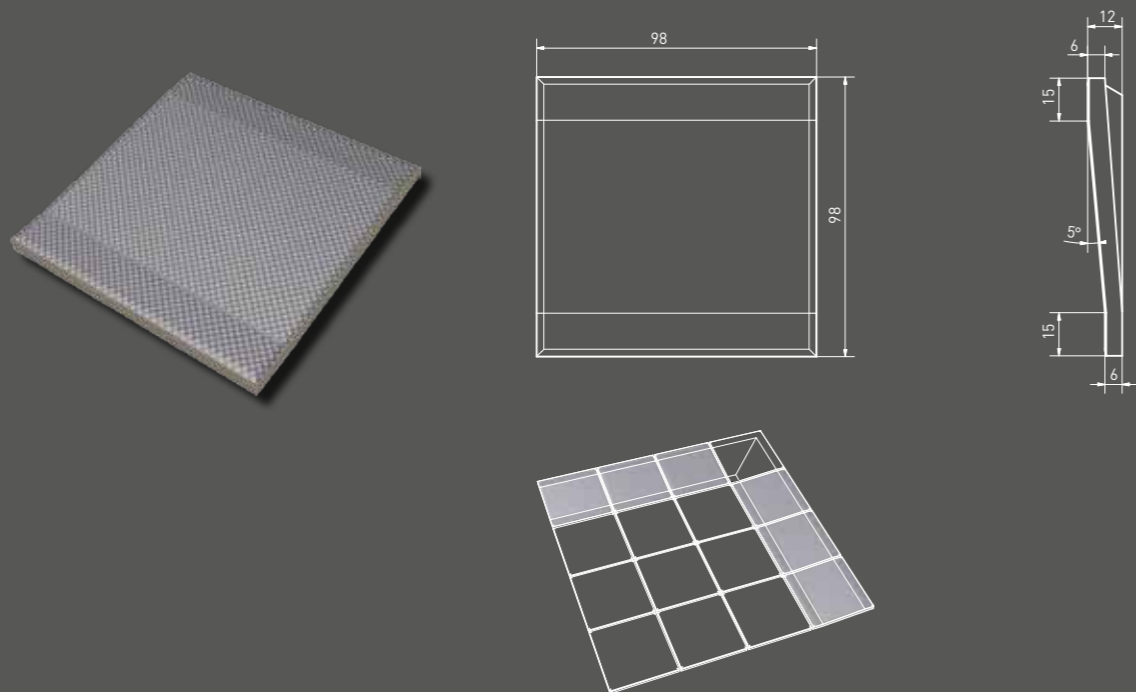

sokl s požlábkem | **GSTON...** | 98x103x6 mm
 cove skirting | **GSTON...** | 98x103x6 mm

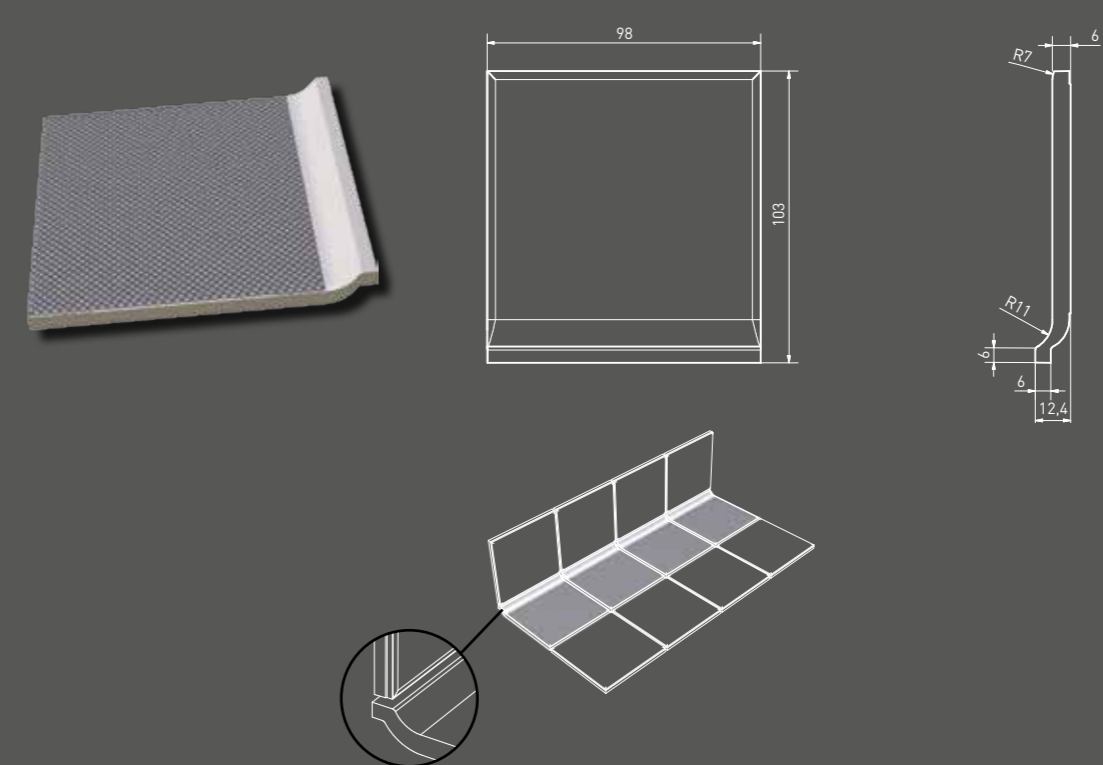

sokl vnitřní roh | **GSIRC...** | 24x103x6 mm
 cove skirting inside corner | **GSIRC...** | 24x103x6 mm

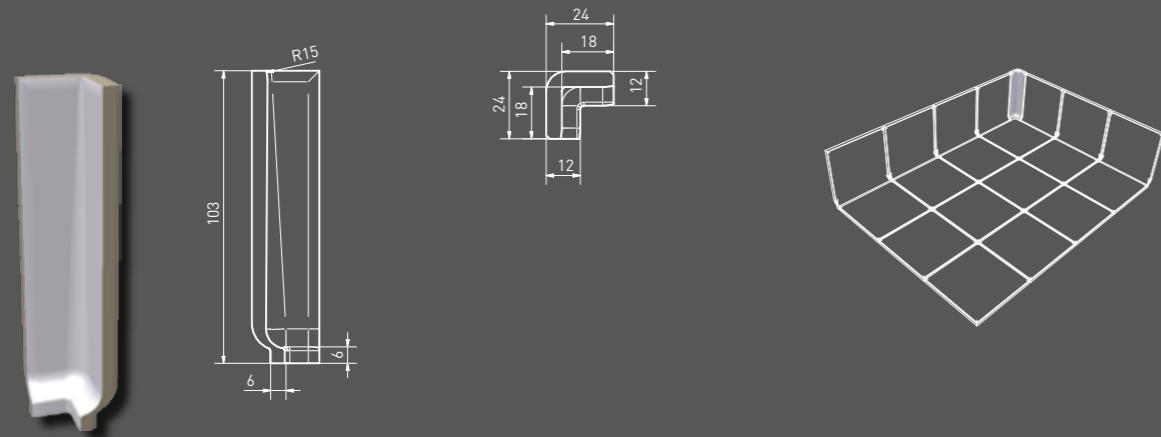

sokl vnější roh | **GSERC...** | 30x103x6 mm
 cove skirting outside corner | **GSERC...** | 30x103x6 mm



vnější roh | **GTVR4...** | 24x24x24 mm
 outside corner | **GTVR4...** | 24x24x24 mm

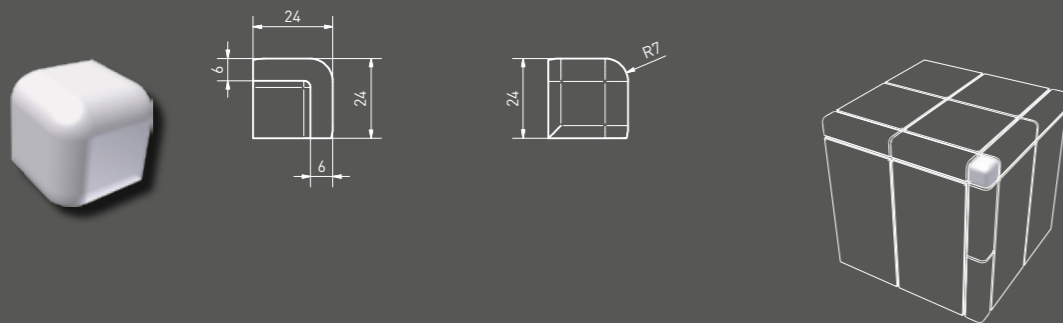

průběžná hrana vnitřní | **GSIA5...** | 24x98x6 mm
 shower piece - inside edge | **GSIA5...** | 24x98x6 mm

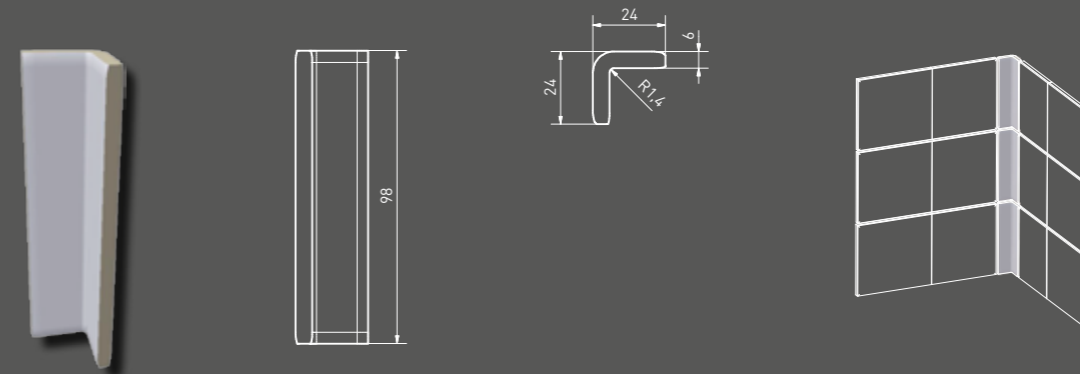

průběžná hrana vnější | **GSEA5...** | 24x98x6 mm
 shower piece - outside edge | **GSEA5...** | 24x98x6 mm

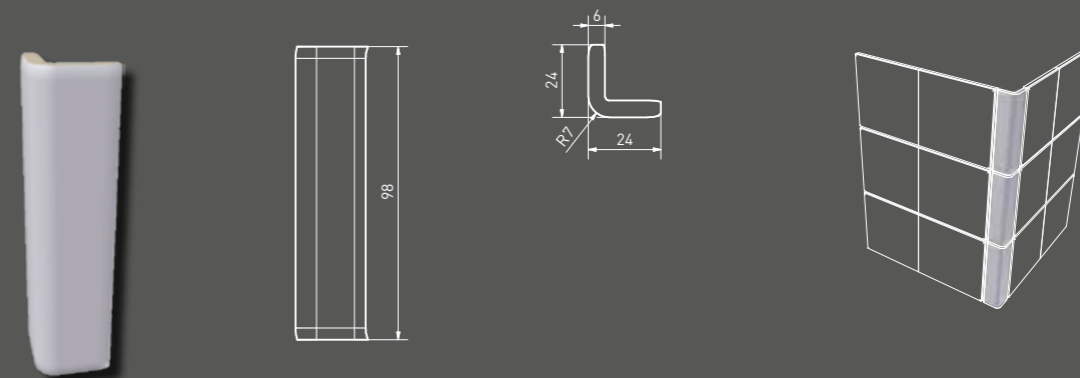

Logistická data | Logistic information

cm	mm		Výrobek Product		ks/m	m ²	m ²	kg	kg/m	brutto kg	
□	□	W									
2,5x2,5	23x23x6		mozaika set 30x30 cm mosaic sheet 30x30 cm	STO č. 030 - 049913	11	1,00	60	60,00	12,9	12,9	799
5x5	48x48x6/48x48x7		mozaika set 30x30 cm mosaic sheet 30x30 cm	STO č. 030 - 049913	11	1,00	60	60,00	12,9	12,9	799
10x10	98x98x6		dlaždice floor tile	EN 14411:2012, annex H B1b GL	11	1,00	60	60,00	12,9	12,9	799
10x20	98x198x7		dlaždice floor tile	EN 14411:2012, annex H B1b GL	35	0,70	90	63,00	10,5	15,0	971
15x15	148x148x7		dlaždice floor tile	EN 14411:2012, annex H B1b GL	22	0,50	136	68,00	7,1	14,2	991
15x15	148x148x7		dlaždice floor tile	EN 14411:2012, annex H B1b GL	44	1,00	68	68,00	14,2	14,2	991
20x20	198x198x7		dlaždice floor tile	EN 14411:2012, annex H B1b GL	25	1,00	72	72,00	15,5	15,5	1 141
30x30	297x297x8		dlaždice floor tile	EN 14411:2012, annex H B1b GL	11	1,00	64	64,00	17,5	17,5	1 145
30x30	298x298x8		dlaždice floor tile	EN 14411:2012, annex G B1a GL	13	1,18	48	56,64	21,0	17,8	1 034
10x10	98x98x6		bezbariérová tvarovka rohová shower piece - corner	STO č. 030 - 049916	18	100	0,18	-	2,34	13,0	-
10x10	98x98x6		bezbariérová tvarovka průběžná shower piece - continuous	STO č. 030 - 049916	18	100	0,18	-	2,34	13,0	-
10x10	98x103x6		sokl s pozábkem cove skirting	STO č. 030 - 049916	-	-	-	-	-	-	-
2,4x10	24x103x6		sokl vnitřní roh cove skirting inside corner	STO č. 030 - 049916	-	-	-	-	-	-	-
3x10	30x103x6		sokl vnější roh cove skirting outside corner	STO č. 030 - 049916	-	-	-	-	-	-	-
2,4x10	24x98x6		průběžná hrana vnitřní shower piece - inside edge	STO č. 030 - 049916	-	-	-	-	-	-	-
2,4x10	24x98x6		průběžná hrana vnější shower piece - outside edge	STO č. 030 - 049916	-	-	-	-	-	-	-
2,4x2,4	24x24x24		vnější roh outside corner	STO č. 030 - 049916	-	-	-	-	-	-	-
20x20	198x204x7		sokl s pozábkem cove skirting	STO č. 030 - 049916	-	-	-	-	-	-	-
2,4x20	24x204x7		sokl vnitřní roh cove skirting inside corner	STO č. 030 - 049916	16	-	-	-	-	-	-
3x20	30x204x7		sokl vnější roh cove skirting outside corner	STO č. 030 - 049916	16	-	-	-	-	-	-
2,4x20	24x198x7		průběžná hrana vnitřní shower piece - inside edge	STO č. 030 - 049916	16	-	-	-	-	-	-
2,4x20	24x198x7		průběžná hrana vnější shower piece - outside edge	STO č. 030 - 049916	16	-	-	-	-	-	-