

TAURUS GRANIT

RUS TAURUS GRANIT – надежное качество

Важными преимуществами изделий серии Taurus GRANIT были и остаются их высокое качество, функциональность и прочность. Для повышения привлекательности предложения серия высокоспекаемой неглазурованной плитки дополнена модульными форматами 30x60 см и 60x60 см в калиброванном исполнении. Новая цветовая гамма соответствует теплым и холодным цветам серии ColorONE и ColorTWO и создают потенциал для креативных дизайнерских решений и комбинирования на определенных объектах. Новые рельефные поверхности удовлетворяют высоким техническим требованиям, прежде всего выдвигаемым к противоскользящим свойствам, в то время как преимуществом полированных поверхностей помимо качества является и эстетический аспект. Кроме этого неотъемлемой частью серии Taurus GRANIT являются фасонные изделия и наборные элементы, позволяющие реализовывать системные решения и обеспечивающие соответствие требованиям к качеству и функциональным аксессуарам.

TAURUS GRANIT

HU TAURUS GRANIT – ellenőrzött minőség

A Taurus GRANIT termékcsalád előnye mindig is a minőség, funkcionalitás és a terheletőség voltak és lesznek. A mázatlan gres választék fejlesztése érdekében a termékcsalád 30x60 cm és 60x60 cm-es retifikált modul méretű lapokkal bővült. Az új színválaszték harmonizál a ColorONE és ColorTWO termékcsalád elemeivel, ezáltal fokozza a variálhatósági lehetőségeket az egyes projektek esetében. Az új felületek, különösen a csúszásmentesség tekintetében, megfelelnek a legmagasabb technikai elvárásoknak, a polírozott felületek pedig a látványos burkolatok kialakítására kínálnak megoldást. A különleges felületek mellett a formadarabok és egyéb kiegészítő elemek teszik teljessé a Taurus GRANIT burkoatrendszert.

TAURUS GRANIT

PL TAURUS GRANIT – sprawdzona jakość

Jakość, funkcjonalność, a przede wszystkim wytrzymałość, były i są ważnymi cechami serii Taurus GRANIT. Dla zwiększenia atrakcyjności, seria wysokospekanych nieszkliwionych płytek gresowych, została poszerzona o modularny format 30x60 cm i 60x60 cm z rektyfikacją krawędzi. Nowa paleta kolorów koresponduje z dzienną i nocną skalą serii ColorONE i ColorTWO i ułatwia kreatywne i różnorodne projektowe rozwiązania. W płytkach z reliefem powierzchni nacisk kładziony jest na wysokie walory techniczne, szczególnie przeciwpoślizgowość, podczas gdy dla płytek polerowanych, obok jakości, na walory estetyczne. Kształtki specjalne, nieodłączny element serii Taurus GRANIT, dopełniają tę doskonałe rozwiązanie systemowe.

TAURUS GRANIT

CZ TAURUS GRANIT – osvědčená kvalita

Kvalita, funkčnost a především odolnost byly a jsou významné benefity série Taurus GRANIT. Pro ztraktivnější nabídky byla série vysoce slintutých neglazovaných dlaždic doplněna o modulový formát 30x60 cm a 60x60 cm v kalibrovaném provedení. Nová barevná paleta koresponduje s nabídkou denních a nočních barev série ColorONE a ColorTWO a podporuje tak kreativní a variabilní potenciál jednotlivých projektů. U nových reliéfních povrchů je kladen důraz na vysoké technické nároky, především protiskluznost, zatímco předností leštěných povrchů je kromě kvality i estetické hledisko. Funkční doplňky, tvárky a ostatní speciality jsou nedílnou součástí série Taurus GRANIT pro dokonalá systémová řešení.

TAURUS GRANIT

EN TAURUS GRANIT – proven quality

Important benefits of the Taurus GRANIT series were and remain quality, functionality and strength. To enhance the offer the series of fully vitrified unglazed tiles is supplemented with the modular formats 30x60 cm and 60x60 cm in rectified versions. A new palette of colours corresponds with the offer of day and night colours of the series ColorONE and ColorTWO and supports both the creative and variable potential of particular projects. High technical demands are fulfilled with the new relief surfaces, particularly for slip resistance, and the polished surfaces meet the criteria for fashionable and pleasing effects. In addition, shaped pieces and other specialities form an integral part of the Taurus GRANIT for perfect system solutions, as well as meeting demands for quality and functional special pieces.

TAURUS GRANIT

TAURUS GRANIT

ES TAURUS GRANIT - calidad comprobada

Calidad, funcionalidad, durabilidad y alta resistencia son las cualidades destacadas e importantes de la serie Taurus GRANIT. Para ampliar la oferta de estas baldosas sin esmaltar altamente vitrificadas se han incluido los formatos modulares calibrados de 30x60 cm y 60x60 cm. La gama de colores corresponde a la gama diurna y nocturna de las series ColorONE y ColorTWO y fomenta el potencial creativo y versátil en los proyectos. Nuevas superficies de relieve es la respuesta de la demanda de superficies técnicas con alto grado de la función antideslizante, mientras en las superficies pulidas se deja el protagonismo a la calidad y estética. Accesorios y piezas técnicas funcionales que forman parte de la serie Taurus GRANIT aseguran soluciones técnicas completas.

EN 14411:2012, annex G Bia UGL				Wyrodek Product		Povrch Surface	Protisklizovnosť Slip resistance koeficient tření - za sucha	69 Rio Negro	65 Antracit	76 Nordic	176 Nordic Light	62 Sahara	61 Tunis	73 Nevada	
cm	mm														
	5x5	48x48x9		mozaika set mosaik sheet 30x30 cm 30x30 cm	S	R10/B $\mu \geq 0,7$	TDM06069 ○ 68 m ²	TDM06065 ○ 68 m ²	TDM06076 ○ 68 m ²				TDM06061 ○ 68 m ²	TDM06073 ○ 68 m ²	
	10x10	98x98x9		dlaždice floor tile	S	R10/B $\mu \geq 0,7$	TAA12069 ○ 86 m ²	TAA12065 ○ 84 m ²	TAA12076 ○ 82 m ²			TAA12062* ○ 84 m ²	TAA12061 ○ 82 m ²	TAA12073 ○ 82 m ²	
	15x15	148x148x9		dlaždice floor tile	S	R10/A $\mu \geq 0,7$	TAA1D069 ○ 80 m ²	TAA1D065 ○ 80 m ²	TAA1D076 ○ 76 m ²				TAA1D061 ○ 76 m ²		
	20x20	198x198x9		dlaždice floor tile	S	R10/A $\mu \geq 0,6$	TAA26069 ○ 80 m ²	TAA26065 ○ 80 m ²	TAA26076 ○ 76 m ²			TAA26062* ○ 78 m ²	TAA26061 ○ 76 m ²	TAA26073 ○ 76 m ²	
					SR3	R12/B $\mu \geq 0,7$	TR326069* ○ 82 m ²	TR326065* ○ 82 m ²	TR326076* ○ 80 m ²				TR326061* ○ 80 m ²		
					SR7	R11/B $\mu \geq 0,7$	TR726069 ○ 82 m ²	TR726065 ○ 82 m ²	TR726076 ○ 78 m ²				TR726061 ○ 78 m ²	TR726073 ○ 78 m ²	
					SRM	R11/B $\mu \geq 0,6$	TRM26069* ○ 82 m ²	TRM260651 ○ 82 m ²	TRM26076 ○ 80 m ²				TRM26061 ○ 80 m ²	TRM26073 ○ 78 m ²	
	30x30	298x298x9		dlaždice floor tile	S	R9/A $\mu \geq 0,6$	TAA35069 ○ 76 m ²	TAA35065 ○ 76 m ²	TAA35076 ○ 60 m ²	TAA35176 ○ 74 m ²	TAA35062 ○ 74 m ²	TAA35061 ○ 66 m ²	TAA35073 ○ 60 m ²		
					SB	R10/A $\mu \geq 0,7$	TAB35069 ○ 78 m ²	TAB35065 ○ 78 m ²	TAB35076 ○ 74 m ²			TAB35061 ○ 74 m ²	TAB35073 ○ 74 m ²		
					SR3	R12/B $\mu \geq 0,7$	TR335069* ○ 84 m ²	TR335065* ○ 84 m ²	TR335076* ○ 74 m ²				TR335061* ○ 74 m ²		
					SR7	R11/B $\mu \geq 0,7$	TR735069 ○ 84 m ²	TR735065 ○ 84 m ²	TR735076 ○ 74 m ²				TR735061 ○ 74 m ²	TR735073 ○ 74 m ²	
					SRM	R11/B $\mu \geq 0,6$	TRM35069* ○ 84 m ²	TRM35065 ○ 84 m ²	TRM35076 ○ 74 m ²				TRM35061 ○ 74 m ²	TRM35073 ○ 74 m ²	
		295x295x8			SL	$\mu \geq 0,5$	TAL35069* ○ 86 m ²	TAL35065* ○ 86 m ²	TAL35076* ○ 86 m ²				TAL35061* ○ 86 m ²	TAL35073* ○ 86 m ²	
	30x60	298x598x10		dlaždice floor tile	S	R9/A $\mu \geq 0,6$	TAASA069 ○ 78 m ²	TAASA065 ○ 78 m ²	TAASA076 ○ 78 m ²			TAASA061 ○ 78 m ²	TAASA073 ○ 78 m ²		
					SRU	R10/B $\mu \geq 0,7$	TRUSA069 ○ 82 m ²	TRUSA065 ○ 82 m ²	TRUSA076 ○ 82 m ²				TRUSA061 ○ 82 m ²	TRUSA073 ○ 82 m ²	
					SL	$\mu \geq 0,5$	TALSA069* ○ 88 m ²	TALSA065* ○ 88 m ²	TALSA076* ○ 88 m ²				TALSA061* ○ 88 m ²	TALSA073* ○ 88 m ²	
	60x60	598x598x10		dlaždice floor tile	S	R9/A $\mu \geq 0,6$	TAA61069 ○ 82 m ²	TAA61065 ○ 82 m ²	TAA61076 ○ 82 m ²				TAA61061 ○ 82 m ²	TAA61073 ○ 82 m ²	
					SRU	R10/B $\mu \geq 0,7$	TRU61069 ○ 86 m ²	TRU61065 ○ 86 m ²	TRU61076 ○ 86 m ²				TRU61061 ○ 86 m ²	TRU61073 ○ 86 m ²	
					SL	$\mu \geq 0,5$	TAL61069* ○ 90 m ²	TAL61065* ○ 90 m ²	TAL61076* ○ 90 m ²				TAL61061* ○ 90 m ²	TAL61073* ○ 90 m ²	

S - Standardní povrch | Standard surface | Standartowa powierzchnia | Стандартная поверхность | Sima felület | Superficie estándar
 SL - Leštěný povrch | Polished surface | Powierzchnia polerowana | Полированная поверхность | Polírozott felület | Superficie pulida
 SB - Hladký protisklizný povrch | Smooth slip-resistant surface | Przeciwpślizgowa powierzchnia bez reliefu (szorstka) | Гладкая с противоскользящей поверхностью | Sima csúszásgátló felülettel | Superficie antideslizante liso
 SR.. - Reliéfní povrch | Relief surface | Powierzchnia reliefowa | Рельефная поверхность | Relief felület | Superficie en relieve

77 Marok	67 Tibet	72 Arabia	74 Gobi	82 Jura	80 Oaza	75 Biskay
	TDM06067 ○ 68 m ²	TDM06072 ○ 68 m ²				
TAA12077 ○ 84 m ²	TAA12067 ○ 86 m ²	TAA12072 ○ 84 m ²				
		TAA1D072 ○ 78 m ²				
TAA26077 ○ 78 m ²	TAA26067 ○ 78 m ²	TAA26072 ○ 78 m ²				
	TR726067 ○ 80 m ²					
	TRM26067 ○ 80 m ²					
TAA35077 ○ 74 m ²	TAA35067 ○ 72 m ²	TAA35072 ○ 74 m ²	TAA35074 ○ 74 m ²	TAA35082 ○ 76 m ²	TAA35080 ○ 74 m ²	TAA35075 ○ 74 m ²
	TAB35067 ○ 76 m ²					
	TR735067 ○ 78 m ²					
	TRM35067 ○ 78 m ²					
TAASA077 ○ 78 m ²	TAASA067 ○ 78 m ²					
TRUSA077 ○ 82 m ²	TRUSA067 ○ 82 m ²					
TALSA077* ○ 88 m ²	TALSA067* ○ 88 m ²					
TAA61077 ○ 82 m ²	TAA61067 ○ 82 m ²					
TRU61077 ○ 86 m ²	TRU61067 ○ 86 m ²					
TAL61077* ○ 90 m ²	TAL61067* ○ 90 m ²					

* Výroba na objednávku | Production by order | Produkcja na zamówienie | Производство под заказ | Gyártás rendelésre | Producción bajo demanda

Barevné odstíny, které jsou zde vyobrazeny, mají pouze orientační charakter. | The colour shades shown are for orientation only. | Odcienie kolorów, które są tu przedstawione, mają wyłącznie charakter orientacyjny. | Цвета/оттенки, изображенные в каталоге, носят ориентировочный характер. | A színárnyalat csak tájékoztató jellegű. | Colores, que se muestran aquí, son sólo indicativos.

STO č. 030 - 049916

Wyrodek
ProductPovrch
SurfaceProtiskliznost
Slip resistance
koeficient tření - za sucha

69 Rio Negro 65 Antracit 76 Nordic 176 Nordic Light 62 Sahara 61 Tunis 73 Nevada

	30x30	298x298x9		schodovka step tile	S	R10/A $\mu \geq 0,6$	TCA35069 ○ 32 ks	TCA35065 ○ 32 ks	TCA35076 ○ 18 ks	TCA35176 ○ 28 ks	TCA35062 ○ 28 ks	TCA35061 ○ 20 ks	TCA35073 ○ 18 ks
	30x30	298x298x9		ext. schodovka ext. step tile	SR7	R11/B $\mu \geq 0,7$	TCV35069 ○ 46 ks	TCV35065 ○ 46 ks	TCV35076 ○ 46 ks			TCV35061 ○ 46 ks	
	60x9,5	598x95x10		sokl skirting plinth	S		TSAS4069 ○ 52 ks	TSAS4065 ○ 52 ks	TSAS4076 ○ 52 ks			TSAS4061 ○ 52 ks	TSAS4073 ○ 52 ks
	30x8	298x80x9		sokl skirting plinth	S		TSAJB069 ○ 28 ks	TSAJB065 ○ 28 ks	TSAJB076 ○ 28 ks	TSAJB176 ○ 28 ks	TSAJB062 ○ 28 ks	TSAJB061 ○ 28 ks	TSAJB073 ○ 28 ks
	30x8	298x80x9		francouzský sokl french skirting	S		TSEJB069* ○ 36 ks	TSEJB065* ○ 36 ks	TSEJB076* ○ 36 ks		TSEJB062* ○ 36 ks	TSEJB061* ○ 36 ks	TSEJB073* ○ 36 ks
	2,5x8	25x80x9		francouzský sokl vnitřní roh french skirting inside corner	S		TSIRF069* ○ 48 ks	TSIRF065* ○ 48 ks	TSIRF076* ○ 48 ks		TSIRF062* ○ 48 ks	TSIRF061* ○ 48 ks	TSIRF073* ○ 48 ks
	2,5x8	25x80x7		francouzský sokl vnější roh french skirting outside corner	S		TSERF069* ○ 48 ks	TSERF065* ○ 48 ks	TSERF076* ○ 48 ks		TSERF062* ○ 48 ks	TSERF061* ○ 48 ks	TSERF073* ○ 48 ks
	15x9	148x90x9		sokl s požlábkem cove skirting	S		TSPCE069 ○ 24 ks	TSPCE065 ○ 24 ks	TSPCE076 ○ 24 ks			TSPCE061 ○ 24 ks	
	20x9	198x90x9		sokl s požlábkem cove skirting	S		TSPEM069 ○ 32 ks	TSPEM065 ○ 32 ks	TSPEM076 ○ 32 ks		TSPEM062* ○ 32 ks	TSPEM061 ○ 32 ks	TSPEM073 ○ 32 ks
	2,3x9	23x90x10		sokl vnitřní roh cove skirting inside corner	S		TSIRB069 ○ 48 ks	TSIRB065 ○ 48 ks	TSIRB076 ○ 48 ks		TSIRB062* ○ 48 ks	TSIRB061 ○ 48 ks	TSIRB073 ○ 48 ks
	2,3x9	23x90x7		sokl vnější roh cove skirting outside corner	S		TSERB069 ○ 48 ks	TSERB065 ○ 48 ks	TSERB076 ○ 48 ks		TSERB062* ○ 48 ks	TSERB061 ○ 48 ks	TSERB073 ○ 48 ks
	30x8	298x80x9		sokl s požlábkem cove skirting	S		TSPJB069* ○ 34 ks	TSPJB065* ○ 34 ks	TSPJB076* ○ 34 ks			TSPJB061* ○ 34 ks	TSPJB073* ○ 34 ks
	2,3x8	23x80x10		sokl vnitřní roh cove skirting inside corner	S		TSIRH069* ○ 48 ks	TSIRH065* ○ 48 ks	TSIRH076* ○ 48 ks			TSIRH061* ○ 48 ks	TSIRH073* ○ 48 ks
	2,3x8	23x80x7		sokl vnější roh cove skirting outside corner	S		TSERH069* ○ 48 ks	TSERH065* ○ 48 ks	TSERH076* ○ 48 ks			TSERH061* ○ 48 ks	TSERH073* ○ 48 ks
	10x10	98x98x8		bezbariérová tvarovka rohová shower piece corner	SB	R10/B $\mu \geq 0,7$	TTR12069 ○ 54 ks	TTR12065 ○ 54 ks	TTR12076 ○ 54 ks			TTR12061 ○ 54 ks	
	10x10	98x98x8		bezbariérová tvarovka průběžná shower piece continuous	SB	R10/B $\mu \geq 0,7$	TTP12069 ○ 54 ks	TTP12065 ○ 54 ks	TTP12076 ○ 54 ks			TTP12061 ○ 54 ks	
	20x7	198x70x8		sokl žlábek skirting groove	S				TSZEF076* ○ 32 ks			TSZEF061* ○ 32 ks	
	30x15	298x150x9		balkónová tvarovka balcony L-shape	S	R9/A $\mu \geq 0,6$	TCFJH065 ○ 62 ks	TCFJH076 ○ 62 ks				TCFJH061 ○ 62 ks	

77 Marok 67 Tibet 72 Arabia 74 Gobi 82 Jura 80 Oaza 75 Biskay



TCA35077 ○ 28 ks	TCA35067 ○ 32 ks	TCA35072 ○ 32 ks	TCA35074 ○ 28 ks	TCA35082 ○ 32 ks	TCA35080 ○ 28 ks	TCA35075 ○ 28 ks
-----------------------	-----------------------	-----------------------	-----------------------	-----------------------	-----------------------	-----------------------

TSAS4077* ○ 52 ks	TSAS4067* ○ 52 ks
------------------------	------------------------

TSAJB077 ○ 28 ks	TSAJB067 ○ 28 ks	TSAJB072 ○ 28 ks	TSAJB074 ○ 28 ks	TSAJB082 ○ 28 ks	TSAJB080 ○ 28 ks	TSAJB075 ○ 28 ks
-----------------------	-----------------------	-----------------------	-----------------------	-----------------------	-----------------------	-----------------------

	TSPCE072 ○ 24 ks
--	-----------------------

TSPEM077 ○ 32 ks	TSPEM067 ○ 32 ks	TSPEM072 ○ 32 ks
-----------------------	-----------------------	-----------------------

TSIRB077* ○ 48 ks	TSIRB067 ○ 48 ks	TSIRB072 ○ 48 ks
------------------------	-----------------------	-----------------------

TSERB077* ○ 48 ks	TSERB067 ○ 48 ks	TSERB072 ○ 48 ks
------------------------	-----------------------	-----------------------

	TSPJB067* ○ 34 ks
--	------------------------

	TSIRH067* ○ 48 ks
--	------------------------

	TSERH067* ○ 48 ks
--	------------------------

	TTR12067 ○ 54 ks
--	-----------------------

	TTP12067 ○ 54 ks
--	-----------------------

S - Standardní povrch | Standard surface | Standartowa powierzchnia | Стандартная поверхность | Sima felület | Superficie estándar
 SL - Leštěný povrch | Polished surface | Powierzchnia polerowana | Полированная поверхность | Polírozott felület | Superficie pulida
 SB - Hladký protisklizný povrch | Smooth slip-resistant surface | Przeciwpoślizgowa powierzchnia bez reliefu (szorstka) | Гладкая с противоскользящей поверхностью | Sima csúszásgátó felülettel | Superficie antideslizante liso
 SR.. - Reliéfní povrch | Relief surface | Powierzchnia reliefowa | Рельефная поверхность | Reliéf felület | Superficie en relieve

* Výroba na objednávku | Production by order | Produkcja na zamówienie | Производство под заказ | Gyártás rendelésre | Producción bajo demanda

Barevné odstíny, které jsou zde vyobrazeny, mají pouze orientační charakter. | The colour shades shown are for orientation only. | Odcienie kolorów, które są tu przedstawione, mają wyłącznie charakter orientacyjny. | Цвета/оттенки, изображенные в каталоге, носят ориентировочный характер. | A színárnyalat csak tájékoztató jellegű. | Colores, que se muestran aquí, son sólo indicativos.

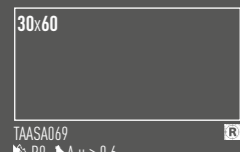

TAASA069
R9 A $\mu \geq 0,6$



TALSA069
 $\mu \geq 0,5$



TAA61069
R9 A $\mu \geq 0,6$



TAA10069
R10 A $\mu \geq 0,7$



TAA26069
R10 A $\mu \geq 0,6$



TAL61069
 $\mu \geq 0,5$

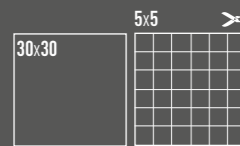

TAA35069
R9 A $\mu \geq 0,6$

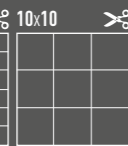

TDM06069
R10 B $\mu \geq 0,7$



TAA12069
R10 B $\mu \geq 0,7$

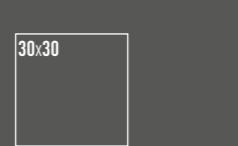

TAL35069
 $\mu \geq 0,5$

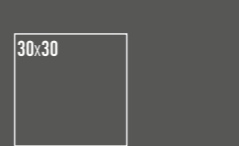

TAB35069
R10 A $\mu \geq 0,7$



TAASA065
R9 A $\mu \geq 0,6$



TALSA065
 $\mu \geq 0,5$



TAA61065
R9 A $\mu \geq 0,6$



TAA10065
R10 A $\mu \geq 0,7$



TAA26065
R10 A $\mu \geq 0,6$



TAL61065
 $\mu \geq 0,5$

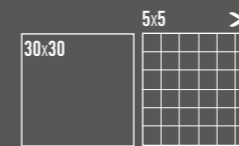

TAA35065
R9 A $\mu \geq 0,6$

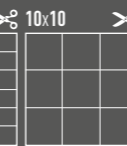

TDM06065
R10 B $\mu \geq 0,7$



TAA12065
R10 B $\mu \geq 0,7$



TAL35065
 $\mu \geq 0,5$

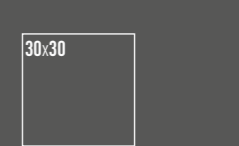

TAB35065
R10 A $\mu \geq 0,7$



69 S Rio Negro



69 SL Rio Negro



69 SB Rio Negro

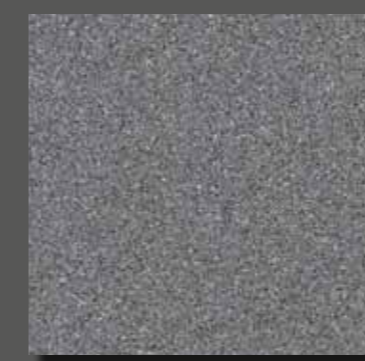

65 S Antracit

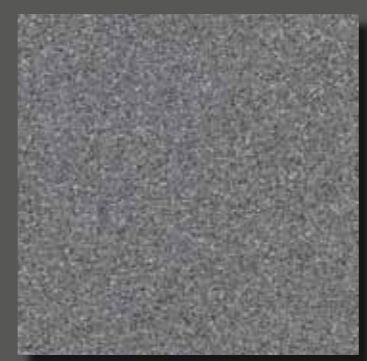

65 SL Antracit



65 SB Antracit

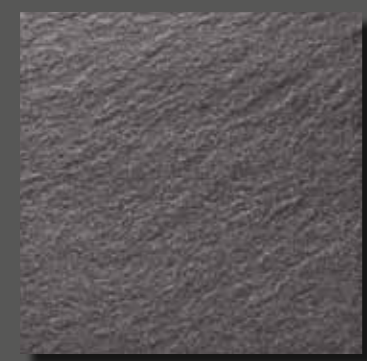

69 SR7 Rio Negro

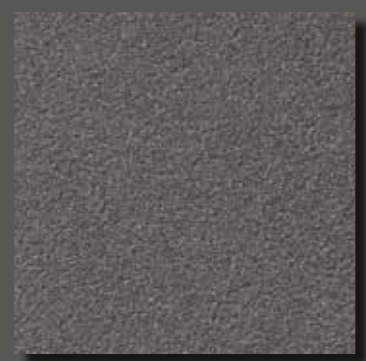

69 SRU Rio Negro



69 SRM Rio Negro
69 SR3 Rio Negro

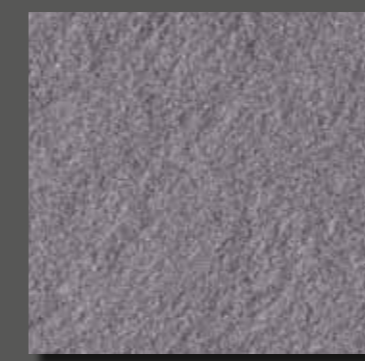

65 SR7 Antracit



65 SRU Antracit

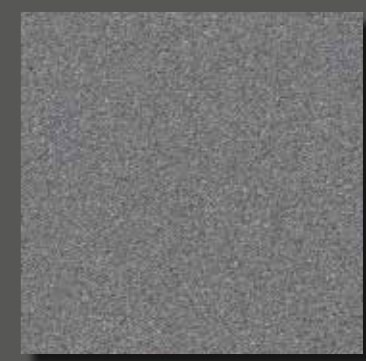

65 SRM Antracit
65 SR3 Antracit



TR735069
R11 B $\mu \geq 0,7$

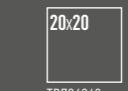

TR726069
R11 B $\mu \geq 0,7$



TRU61069
R10 B $\mu \geq 0,7$

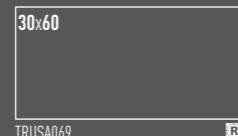

TRUSA069
R10 B $\mu \geq 0,7$



TRM35069
R11 B $\mu \geq 0,6$

TR335069
R12 B $\mu \geq 0,7$



TRM26069
R11 B $\mu \geq 0,6$

TR326069
R12 B $\mu \geq 0,7$



TR735065
R11 B $\mu \geq 0,7$



TR726065
R11 B $\mu \geq 0,7$



TRU61065
R10 B $\mu \geq 0,7$

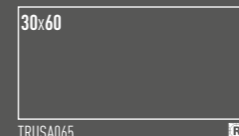

TRUSA065
R10 B $\mu \geq 0,7$



TRM35065
R11 B $\mu \geq 0,6$

TR335065
R12 B $\mu \geq 0,7$



TRM26065
R11 B $\mu \geq 0,6$

TR326065
R12 B $\mu \geq 0,7$



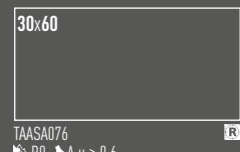

TAASA076
R9 A $\mu \geq 0,6$



TALSA076
 $\mu \geq 0,5$



TAA61076
R9 A $\mu \geq 0,6$



TAA10076
R10 A $\mu \geq 0,7$



TAA26076
R10 A $\mu \geq 0,6$



TAL61076
 $\mu \geq 0,5$

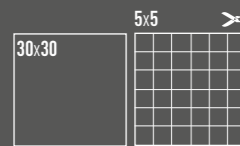

TAA35076
R9 A $\mu \geq 0,6$

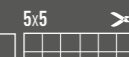

TDM06076
R10 B $\mu \geq 0,7$



TAA12076
R10 B $\mu \geq 0,7$



TAL35076
 $\mu \geq 0,5$



TAB35076
R10 A $\mu \geq 0,7$



TAA35176
R9 A $\mu \geq 0,6$

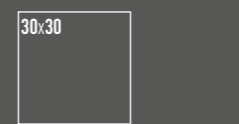

TAA35062
R9 A $\mu \geq 0,6$



TAA26062
R10 A $\mu \geq 0,6$



TAA12062
R10 B $\mu \geq 0,7$



76 S Nordic



76 SL Nordic

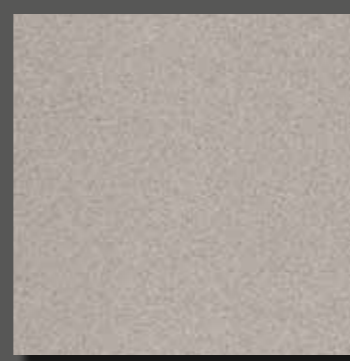

76 SB Nordic



176 S Nordic Light

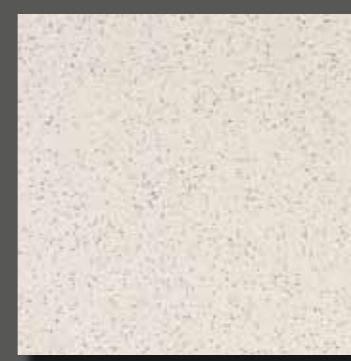

62 S Sahara



76 SR7 Nordic



76 SRU Nordic

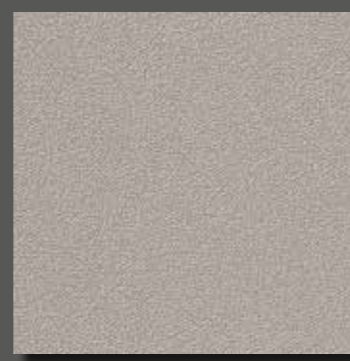

76 SRM Nordic
76 SR3 Nordic

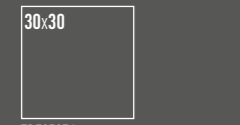

TR735076
R11 B $\mu \geq 0,7$



TR726076
R11 B $\mu \geq 0,7$



TRU61076
R10 B $\mu \geq 0,7$



TRUSA076
R10 B $\mu \geq 0,7$



TRM35076
R11 B $\mu \geq 0,6$

TR335076
R12 B $\mu \geq 0,7$



TRM26076
R11 B $\mu \geq 0,6$

TR326076
R12 B $\mu \geq 0,7$





TAASA061
R9 A $\mu \geq 0,6$



TALSA061
 $\mu \geq 0,5$



TAA61061
R9 A $\mu \geq 0,6$



TAA10061
R10 A $\mu \geq 0,7$



TAA26061
R10 A $\mu \geq 0,6$



TAL61061
 $\mu \geq 0,5$

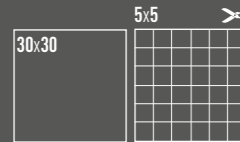

TAA35061
R9 A $\mu \geq 0,6$

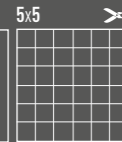

TDM06061
R10 B $\mu \geq 0,7$

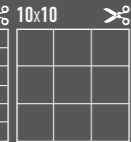

TAA12061
R10 B $\mu \geq 0,7$



TAL35061
 $\mu \geq 0,5$



TAB35061
R10 A $\mu \geq 0,7$



TAASA073
R9 A $\mu \geq 0,6$



TALSA073
 $\mu \geq 0,5$



TAA61073
R9 A $\mu \geq 0,6$



TAA26073
R10 A $\mu \geq 0,6$



TAL61073
 $\mu \geq 0,5$

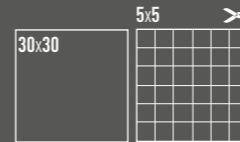

TAA35073
R9 A $\mu \geq 0,6$

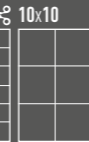

TDM06073
R10 B $\mu \geq 0,7$

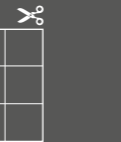

TAA12073
R10 B $\mu \geq 0,7$



TAL35073
 $\mu \geq 0,5$



TAB35073
R10 A $\mu \geq 0,7$



61 S Tunis



61 SL Tunis



61 SB Tunis



73 S Nevada



73 SL Nevada



73 SB Nevada



61 SR7 Tunis



61 SRU Tunis



61 SRM Tunis
61 SR3 Tunis



73 SR7 Nevada



73 SRU Nevada



73 SRM Nevada



TR735061
R11 B $\mu \geq 0,7$



TR726061
R11 B $\mu \geq 0,7$



TRU61061
R10 B $\mu \geq 0,7$

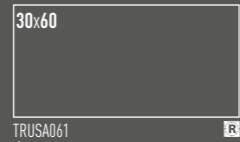

TRUSA061
R10 B $\mu \geq 0,7$

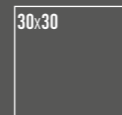

TRM35061
R11 B $\mu \geq 0,6$

TR335061
R12 B $\mu \geq 0,7$



TRM26061
R11 B $\mu \geq 0,6$

TR326061
R12 B $\mu \geq 0,7$

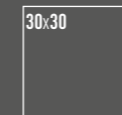

TR735073
R11 B $\mu \geq 0,7$



TR726073
R11 B $\mu \geq 0,7$



TRU61073
R10 B $\mu \geq 0,7$



TRUSA073
R10 B $\mu \geq 0,7$

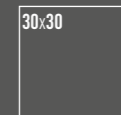

TRM35073
R11 B $\mu \geq 0,7$



TRM26073
R11 B $\mu \geq 0,7$





TAASA077
R9 A $\mu \geq 0,6$



TALSA077
 $\mu \geq 0,5$



TAA61077
R9 A $\mu \geq 0,6$



TAL61077
 $\mu \geq 0,5$



TAA26077
R10 A $\mu \geq 0,6$



TAA35077
R9 A $\mu \geq 0,6$

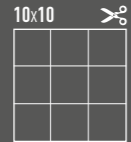

TAA12077
R10 B $\mu \geq 0,7$



77 S Marok



77 SL Marok

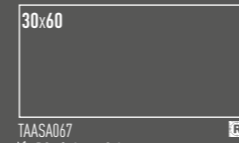

TAASA067
R9 A $\mu \geq 0,6$

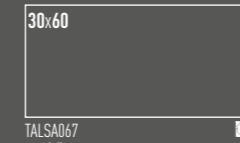

TALSA067
 $\mu \geq 0,5$



TAA61067
R9 A $\mu \geq 0,6$



TAL61067
 $\mu \geq 0,5$

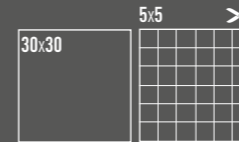

TAA35067
R9 A $\mu \geq 0,6$



TDM06067
R10 B $\mu \geq 0,7$



TAA12067
R10 B $\mu \geq 0,7$



67 S Tibet



67 SL Tibet



TAB35067
R10 A $\mu \geq 0,7$



67 SB Tibet

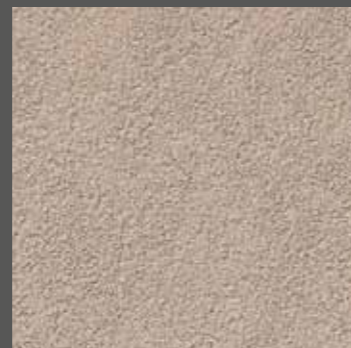

77 SRU Marok

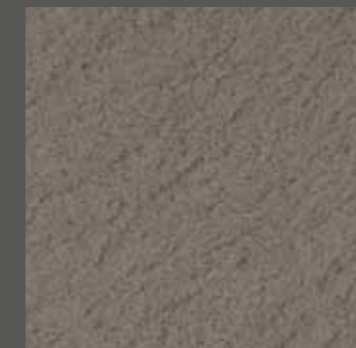

67 SR7 Tibet



67 SRU Tibet



67 SRM Tibet



TR735067
R11 B $\mu \geq 0,7$



TR726067
R11 B $\mu \geq 0,7$



TRU61067
R10 B $\mu \geq 0,7$



TRM35067
R11 B $\mu \geq 0,6$



TRM26067
R11 B $\mu \geq 0,6$



TRU61077
R10 B $\mu \geq 0,7$

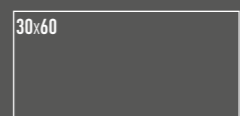

TRUSA077
R10 B $\mu \geq 0,7$

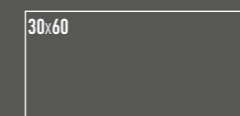

TRUSA067
R10 B $\mu \geq 0,7$



15x15
TAA10072
R10 A μ ≥ 0,7

20x20
TAA26072
R10 A μ ≥ 0,6

30x30
TAA35072
R9 A μ ≥ 0,6

5x5
TDM06072
R10 B μ ≥ 0,7

10x10
TAA12072
R10 B μ ≥ 0,7

30x30
TAA35074
R9 A μ ≥ 0,6

30x30
TAA35082
R9 A μ ≥ 0,6

30x30
TAA35080
R9 A μ ≥ 0,6

30x30
TAA35075
R9 A μ ≥ 0,6

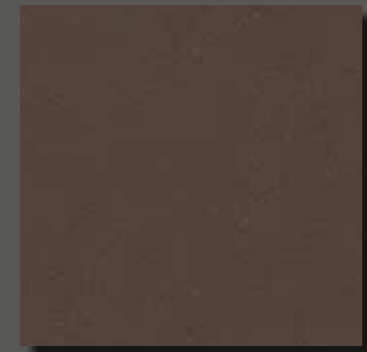

72 S Arabia



74 S Gobi



82 S Jura

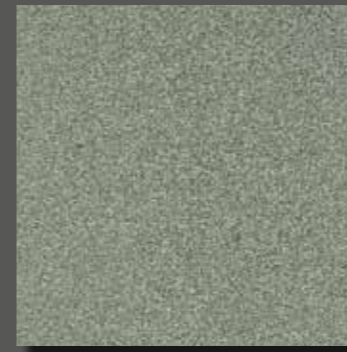

80 S Oaza



75 S Biskay



schodovka | **TCA35...** | 298x298x9 mm
step tile | **TCA35...** | 298x298x9 mm

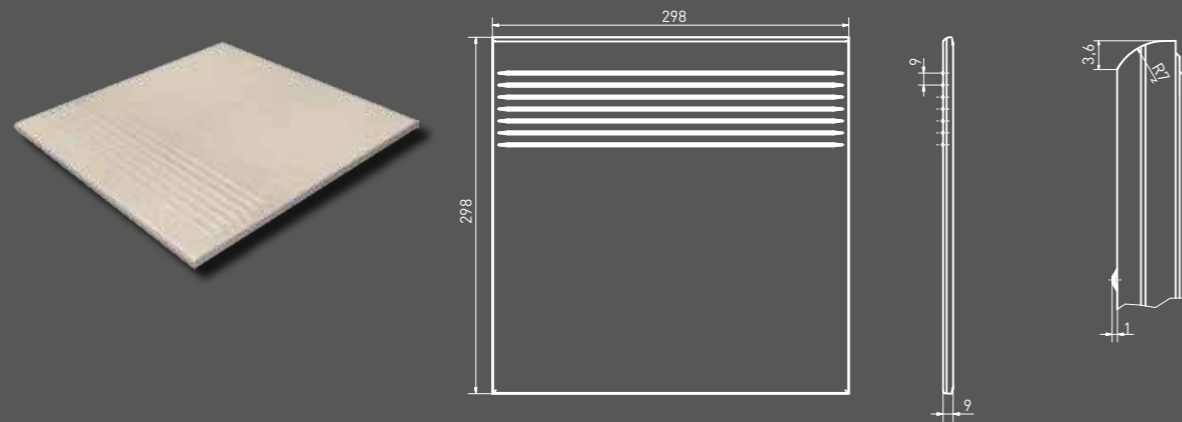

exteriérová schodovka | **TCV35...** | 298x298x9 mm
outside step tile | **TCV35...** | 298x298x9 mm

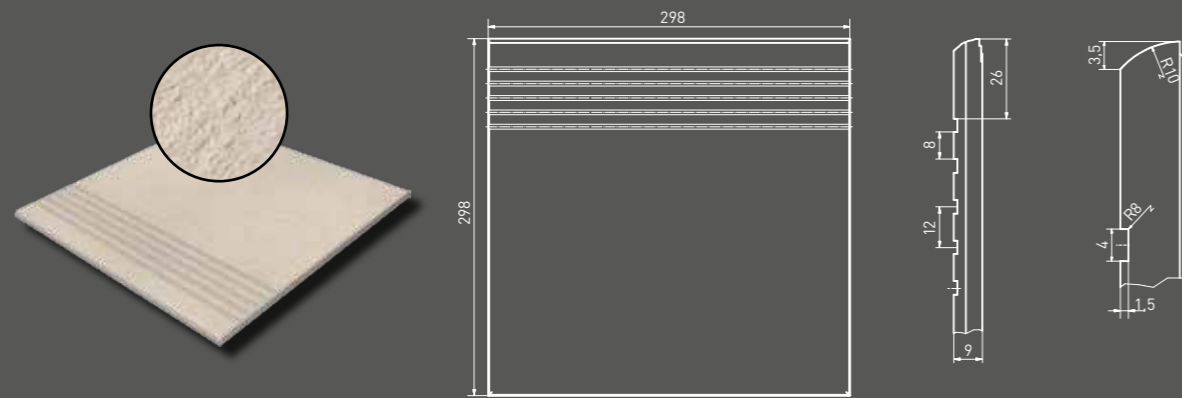

francouzský sokl | **TSFJB...** | 298x80x9 mm
french skirting | **TSFJB...** | 298x80x9 mm

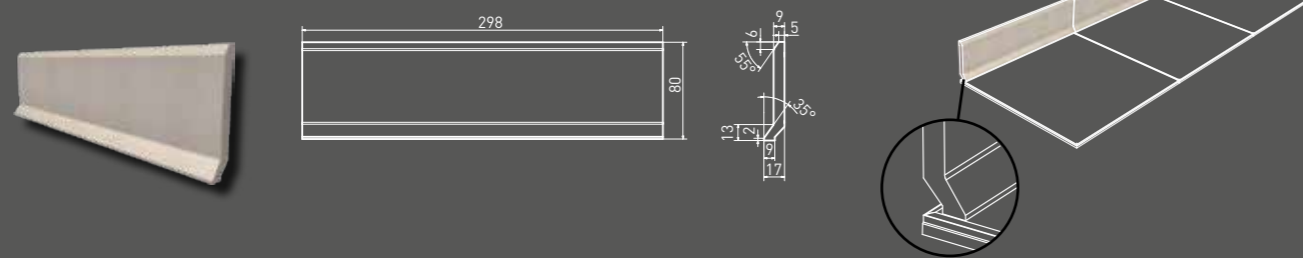

francouzský sokl vnitřní roh | **TSIRF...** | 25x80x9 mm
french skirting inside corner | **TSIRF...** | 25x80x9 mm

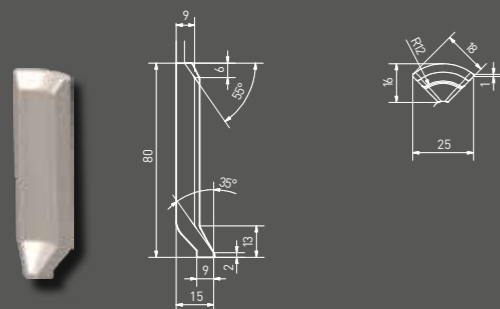

francouzský sokl vnější roh | **TSERF...** | 25x80x7 mm
french skirting outside corner | **TSERF...** | 25x80x7 mm

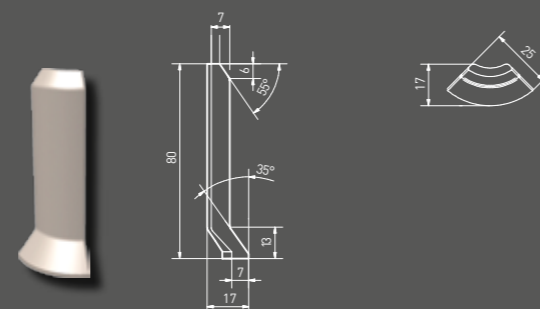

sokl | **TSAS4...** | 598x95x10 mm
skirting plinth | **TSAS4...** | 598x95x10 mm

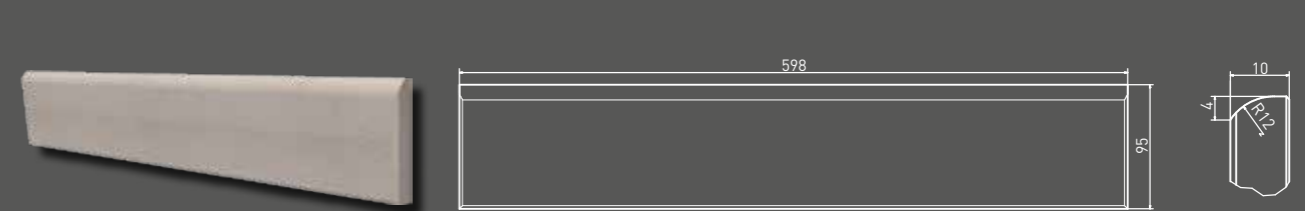

sokl | **TSAJB...** | 298x80x9 mm
skirting plinth | **TSAJB...** | 298x80x9 mm

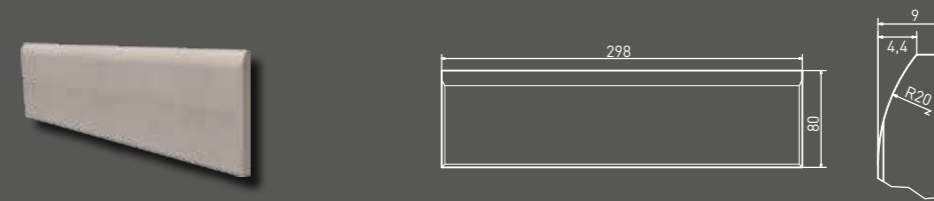

sokl s požlábkem | **TSPCE...** | 148x90x9 mm
cove skirting | **TSPCE...** | 148x90x9 mm

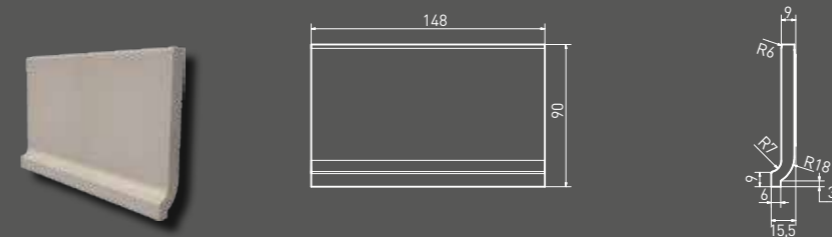

sokl s požlábkem | **TSPEM...** | 198x90x9 mm
cove skirting | **TSPEM...** | 198x90x9 mm

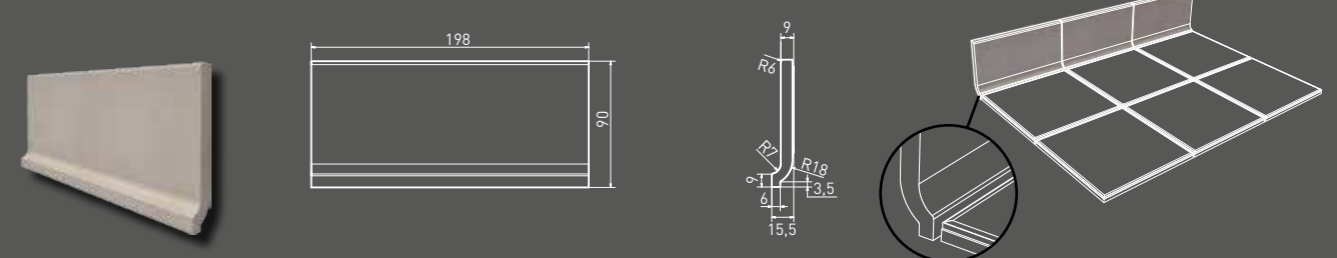

sokl vnitřní roh | **TSIRB...** | 23x90x10 mm
cove skirting inside corner | **TSIRB...** | 23x90x10 mm

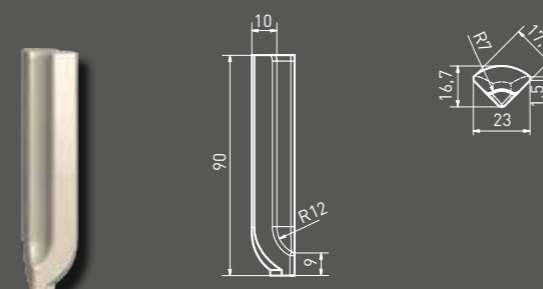

sokl vnější roh | **TSERB...** | 23x90x7 mm
cove skirting outside corner | **TSERB...** | 23x90x7 mm

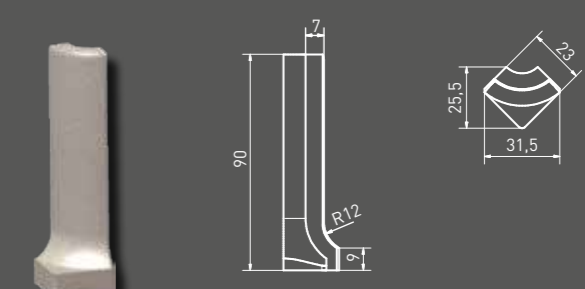



sokl s poźlábkem | **TSPJB...** | 298x80x9 mm
cove skirting | **TSPJB...** | 298x80x9 mm

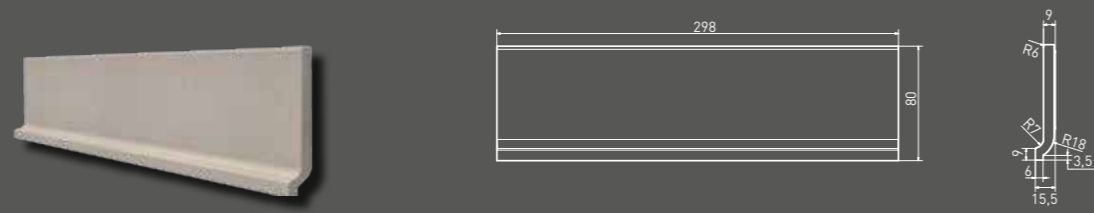

sokl vnitřní roh | **TSIRH...** | 23x80x10 mm
cove skirting inside corner | **TSIRH...** | 23x80x10 mm

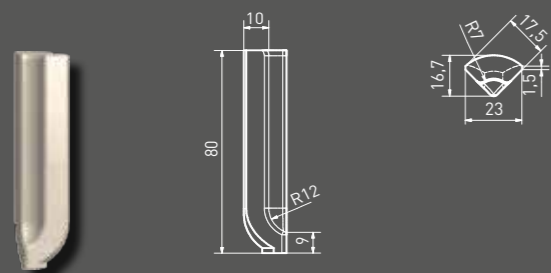

sokl vnější roh | **TSERH...** | 23x80x7 mm
cove skirting outside corner | **TSERH...** | 23x80x7 mm

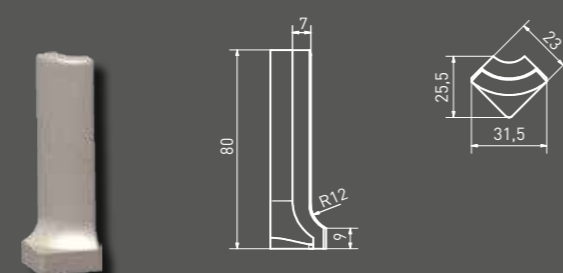

bezbariérová tvarovka rohová | **TTR12...** | 98x98x8 mm
shower piece - corner | **TTR12...** | 98x98x9 mm

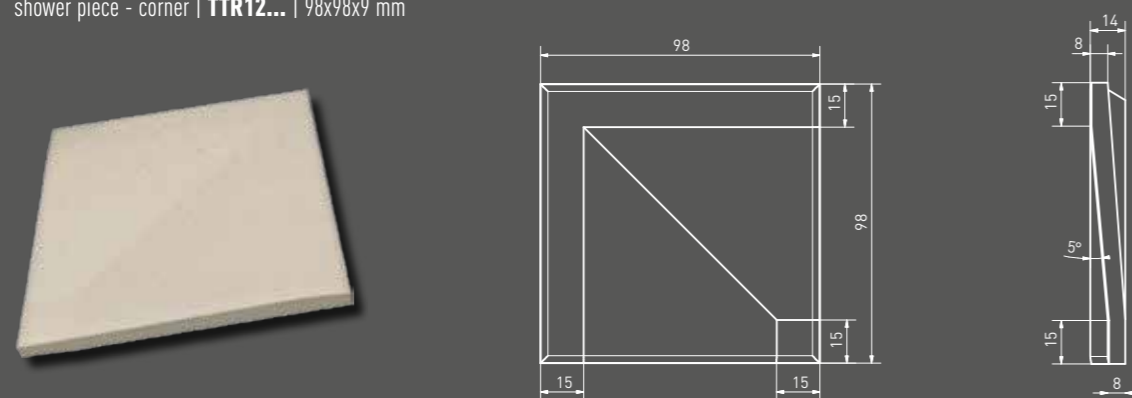

bezbariérová tvarovka průběžná | **TTP12...** | 98x98x8 mm
shower piece - continuous | **TTP12...** | 98x98x9 mm

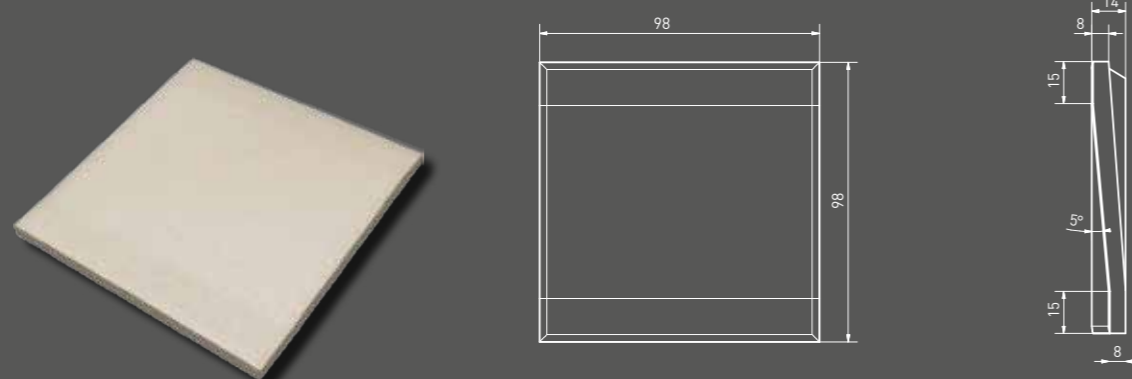

sokl - žlábek | **TSZEF...** | 198x70x8 mm
skirting - groove | **TSZEF...** | 198x70x8 mm

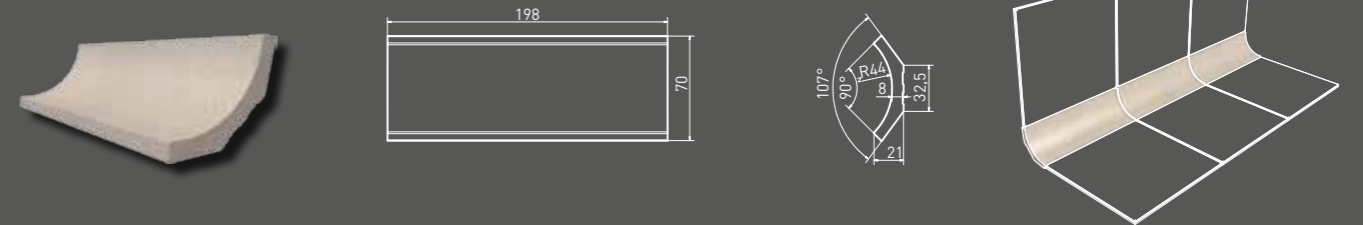

balkónová tvarovka | **TCFJH...** | 298x150x9 mm
balcony L-shape | **TCFJH...** | 298x150x9 mm

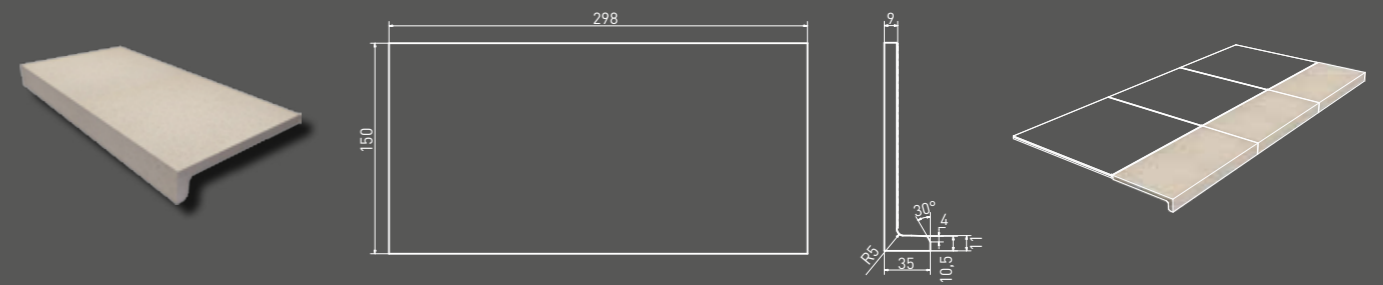

Logistická data | Logistic information

cm	mm	W	Výrobek Product	STO č.	ks/m ²	m ²	m ³	kg	kg/m ²	brutto kg
5x5	48x48x9		mozaika set 30x30 cm mosaic sheet 30x30 cm	STO č. 030 - 049913	3	11	0,27	-	5,2	19,2
10x10	98x98x9		dlaždice floor tile	EN 14411:2012, annex G Bla UGL	11	11	1,00	56	56,00	19,2
15x15	148x148x9		dlaždice floor tile	EN 14411:2012, annex G Bla UGL	27	44	0,61	86	52,46	11,7
20x20	198x198x9		dlaždice floor tile	EN 14411:2012, annex G Bla UGL	25	25	1,00	57	57,00	19,2
30x30	298x298x9		dlaždice floor tile	EN 14411:2012, annex G Bla UGL	12	11	1,09	48	52,32	21,0
30x30	295x295x8		dlaždice (TAL35...) floor tile (TAL35...)	EN 14411:2012, annex G Bla UGL	12	11	1,09	-	19,8	18,2
30x60	298x598x10		dlaždice floor tile	EN 14411:2012, annex G Bla UGL	6	5,6	1,08	40	43,20	25,0
30x60	298x598x10		dlaždice (TALSA...) floor tile (TALSA...)	EN 14411:2012, annex G Bla UGL	6	5,6	1,08	-	25,0	23,1
60x60	598x598x10		dlaždice floor tile	EN 14411:2012, annex G Bla UGL	3	2,8	1,08	32	34,56	25,0
60x60	595x595x10		dlaždice (TAL61...) floor tile (TAL61...)	EN 14411:2012, annex G Bla UGL	3	2,8	1,08	-	25,0	23,1
30x30	298x298x9		schodovka step tile	STO č. 030 - 049916	12	11	1,09	48	52,32	21,0
30x30	298x298x9		exteriérová schodovka outside step tile	STO č. 030 - 049916	11	11	1,00	52	52,00	19,2
60x9,5	598x95x10		sokl skirting plinth	STO č. 030 - 049916	13	17,5	0,74	-	15,9	21,5
30x8	298x80x9		sokl skirting plinth	STO č. 030 - 049916	21	42	0,50	77	38,50	9,5
30x8	298x80x9		francouzský sokl french skirting	STO č. 030 - 049916	21	42	0,50	77	38,50	9,5
2,5x8	25x80x9		francouzský sokl vnitřní roh french skirting inside corner	STO č. 030 - 049916	-	-	-	-	-	-
2,5x8	25x80x7		francouzský sokl vnější roh french skirting outside corner	STO č. 030 - 049916	-	-	-	-	-	-
15x9	148x90x9		sokl s poźlábkem cove skirting	STO č. 030 - 049916	26	74	0,35	-	6,7	19,2
20x9	198x90x9		sokl s poźlábkem cove skirting	STO č. 030 - 049916	22	55	0,40	-	7,7	19,2
2,3x9	23x90x10		sokl vnitřní roh cove skirting inside corner	STO č. 030 - 049916	-	-	-	-	-	-
2,3x9	23x90x7		sokl vnější roh cove skirting outside corner	STO č. 030 - 049916	-	-	-	-	-	-
30x8	298x80x9		sokl s poźlábkem cove skirting	STO č. 030 - 049916	21	42	0,50	77	38,50	9,5
2,3x8	23x80x10		sokl vnitřní roh cove skirting inside corner	STO č. 030 - 049916	-	-	-	-	-	-
2,3x8	23x80x7		sokl vnější roh cove skirting outside corner	STO č. 030 - 049916	-	-	-	-	-	-
10x10	98x98x9		bezbariérová tvarovka rohová shower piece - corner	STO č. 030 - 049916	16	100	0,18	-	2,34	13,0
10x10	98x98x9		bezbariérová tvarovka průběžná shower piece - continuous	STO č. 030 - 049916	16	100	0,18	-	2,34	13,0
20x7	198x70x8		sokl-žlábek skirting-groove	STO č. 030 - 049916	24	71	0,34	-	7,2	21,2
30x15	298x150x9		balkónová tvarovka balcony L-element	STO č. 030 - 049916	8	22	0,36	44	15,84	9,7

