



BATH COLLECTION

BIANCA™

For a deeply comfortable soak, choose a deep bathtub. The 18.5-inch depth of the **BIANCA™** freestanding bathtub epitomizes the pleasure of "sinking into a warm bath." Add straight pillows for more pampering.

FREESTANDING
66" L X 36" W X 24" H

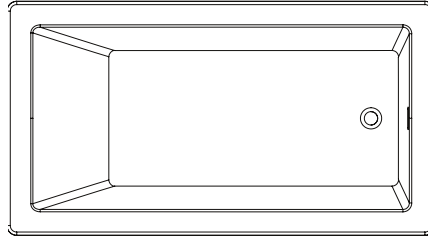

BIANCA™ 6636 SOAKING BATH



BATHTUB FILLERS

The Jacuzzi® Era™ Bathtub Fillers and Accessories collection features superior design in popular installation types and finishes.



ERA™ FLOOR-MOUNTED STYLE

ERA™ FREESTANDING BATHTUB FILLERS: WALL-MOUNTED OR FLOOR-MOUNTED STYLES

AVAILABLE FINISHES

CHROME
BRUSHED NICKEL
BRIGHT BRASS

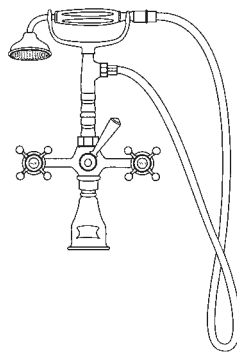

ERA™ WALL-MOUNTED

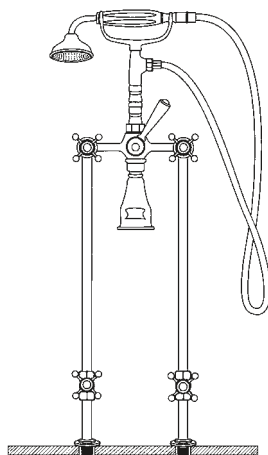

ERA™ WITH SUPPLY LINES

ERA™ TUB FILLERS

- Hand shower and cradle
- Wide-mouth spout
- Cross handles
- White ceramic details
- Flexible stainless steel hose
- For use with the Era™ and other bathtubs

ACCESSORIES

Freestanding bathtub supply lines with shutoffs (for floor-mount installations).

Era™ Freestanding bathtub toe-tap drain kit (if used on Era™ Slipper 6934, the Era™ Slipper Overflow Gasket Kit is required).

OPTIONS & ACCESSORIES

BATH SKIRTS

Get a customized look without the hassle and expense of building a surround or deck for your new Jacuzzi® bathtub. Baths with integral skirts are shown, or choose from skirting options, available on select models and sizes.



HAND RAILS

Feel more secure getting in and out of the bath. Sets of two handrails are available in Chrome, Brushed Nickel and Oil-Rubbed Bronze.



ELARA® PURE AIR® BATH

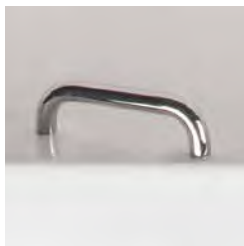

FRAMES & LEGS



FUZION® BATHTUB
WOOD FRAMES



ERA™ DOUBLE-ENDED BATHTUB
WOOD FRAME WITH LEGS



ERA™ DOUBLE-ENDED BATHTUB
WHITE PEDESTAL BASE



ERA™ DOUBLE-ENDED BATHTUB
BALL & CLAW FEET



ERA™ SLIPPER BATHTUB
BALL & CLAW FEET



ACCESSORIES (continued)

PILLOWS

Pillows support your head and neck for added comfort in the bath.



SMALL CURVED
NECK PILLOW
4" X 9"

CURVED PILLOW
6" X 15"
STRAIGHT PILLOW
5" X 15"

STRAIGHT PILLOW
7.5" X 21"

FUZION®
REPLACEMENT
PILLOW
5.2" X 20"

JET RING TRIM KITS

Enhance the look of your bath with a simple change.



Want to add some extra elegance to your bathtub? TargetPro™ jets, older TheraPro™ jets, and AccuPro™ jets can be upgraded post-installation with metal finish jet trim rings – available in Chrome, Brushed Nickel and Oil-Rubbed Bronze.



WHITE



CHROME



BRUSHED NICKEL



OIL-RUBBED BRONZE

TILE FLANGE KIT

Use to help customize the tile around the bath in an alcove installation.

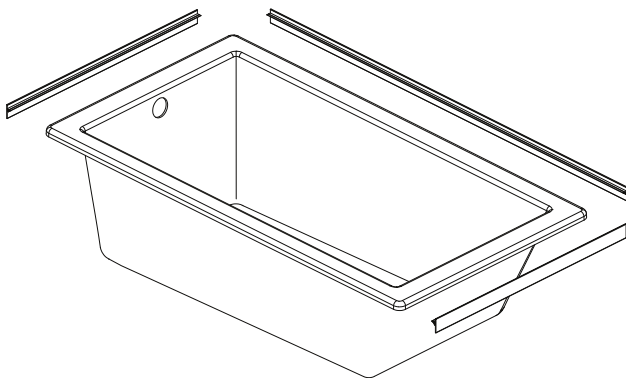

Note: While Elara® and Linea® bathtubs can be ordered with metallic trim finishes factory-installed, all other bathtub families come with acrylic-matched TargetPro™ jet trim rings. TargetPro™ jets with Illumatherapy™ lighting come standard with acrylic-matched trim rings.

DRAINS & DRAIN KITS

Available in Chrome, Brushed Nickel and Oil-Rubbed Bronze.

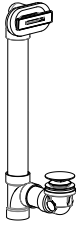

LINEAR OVERFLOW DRAIN KIT

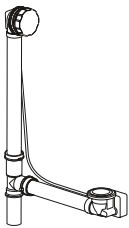

UNIVERSAL ROTARY/CABLE DRAIN KIT,
26" CABLE

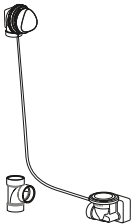

ROTARY DRAIN PVC DRAIN KIT, 26" CABLE
(Does not include waste and overflow pipes)

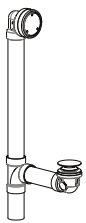

UNIVERSAL DEEP SOAK DRAIN KIT
(Only compatible with Soaking bathtubs
without electronic controls)



ERA™ FREESTANDING TOE-TAP DRAIN KIT
(Requires purchase of GV11 Gasket kit if used
on Era™ Slipper 6934)



TOE-TAP DRAIN FOR VERONA®, TORINO™
AND URBINO™ SOLID SURFACE BATHTUBS
(Brushed Nickel and Oil-Rubbed Bronze drains
must be bought at time of bath purchase)

RAPIDHEAT™ INLINE HEATER

Use on compatible Jacuzzi® Whirlpool tubs to keep bathwater warm as you take your time relaxing.



JACUZZI® SYSTEMS CLEAN™

The two-part cleaner and deodorizer for all whirlpool bath plumbing systems.

- Minimizes residue build-up
- Fast-acting, deep cleaning power
- Breathes new life into whirlpool baths



FINISHES/OPTIONS



FUZION® WITH WENGE FRAME

OPTIONAL
WOOD FRAME



TEAK



WENGE



FUZION® WHIRLPOOL SHOWN WITH
OPTIONAL WOOD FRAME

Choose from Teak, Wenge or no-stain wood finishes for frames (select models). CAD drawings for custom decks, for use by your design professional, can be downloaded at www.jacuzziiluxurybath.com.



UNFINISHED
STAIN TO MATCH
YOUR BATHROOM



FUZION®
WITH CUSTOM-
MADE SOLID
SURFACE DECK

SOLID SURFACES

Luxecast™ Solid Surface is durable, stain-resistant and easy to clean. Every product is factory-tested to meet UL and IAPMO standards. Proudly cast in the USA. Finish options are available on Torino™, Urbino™, and Verona® baths.



GLOSS



WHITE



GLOSS INSIDE / MATTE OUTSIDE



OYSTER



MATTE



BLACK



MATTE INSIDE / GLOSS OUTSIDE



BLACK / WHITE

VERONA®

BRAVO™

QUALITY CONSTRUCTION

Stronger and more durable than gelcoat fiberglass, the high-gloss acrylic sheet on our baths is reinforced with a proprietary fiberglass/resin formula.

FINISHING TOUCHES

Details that complement your bathroom's decor add subtle style. Three options, including Chrome, are available in the Linear Overflow Drain cover and drain.



CHROME



BRUSHED NICKEL



OIL-RUBBED BRONZE

JACUZZI® BATH COLLECTION

COMPARE FEATURES

- Standard Features
- Upgrades

Note: All models available as a Soaking bath

	ALLUSION® 6636	ALLUSION® 7236	ALLUSION® 7242	AMIGA® 7236	BELLAVISTA™ 6042	BELLAVISTA™ 6642	BELLAVISTA™ 7242	BELLAVISTA™ 6060	BIANCA™ 6636	BRAVO™ 6636	CAPELLA® 5555	CAPELLA® 6060	CELESTE™ 7032	CETRA® 6032	CETRA® 6036	DUETTA® 6042	DUETTA® 6636	DUETTA® 6642	DUETTA® 7242	
SPECIFICATIONS																				
Exterior Length (inches)	66	72	72	72	60	66	72	60	66	66	55	60	70	60	60	60	66	66	72	
Exterior Width (inches)	36	36	42	36	42	42	42	60	36	36	55	60	32	32	36	42	36	42	42	
Shape																				
Bathers																				
Max Gallons	75	83	95	78	78	88	95	92	89	60	72	84	67	62	67	83	79	97	108	
Drain Location	Center	Center	Center	End	Center	Center	Center	Center	End	Center	Center	Center	Center	End	End	Center	Center	Center	Center	
FEATURES																				
Tru-Level® Base or Adjustable Feet	●	●	●	●	●	●	●	●	●	●	●	●	●	●	●	●	●	●	●	
Slip-Resistant Bottom	●	●	●	●	●	●	●	●	●	●	●	●	●	●	●	●	●	●	●	
Armrest				●	●	●	●	●			○			●	●					
Handrail																				
SALON® SPA																				
Heated Blower	900w	900w	900w		900w	900w	900w	900w								900w	900w	900w	900w	
Total Jets	10	10	10		10	10	10	10								16	16	16	16	
Bottom Air Injectors	●	●	●		●	●	●	●								●	●	●	●	
Chromatherapy Lighting	●	●	●		●	●	●	●								●	●	●	●	
Illumatherapy™ Jet Lighting	○	○	○		○	○	○	○								○	○	○	○	
Auto-Dri™ (drain activated)	●	●	●		●	●	●	●								●	●	●	●	
Wave Mode	●	●	●		●	●	●	●								●	●	●	●	
RapidHeat™ Inline Heater	●	●	●		●	●	●	●								●	●	●	●	
Whisper Technology™	○	○	○		○	○	○	○								○	○	○	○	
J5 LCD Control	○	○	○		○	○	○	○								○	○	○	○	
WHIRLPOOL																				
Total Jets	10	10	10	8	10	10	10	10			8	8		8	8	16	16	16	16	
TargetPro™ Jets	4	4	4	4	4	4	4	4			4	4		4	4	4	4	4	4	
SlimPro® Jets																				
AccuPro™ Jets	6	6	6	4	2	2	2	3			4	4		4	4	12	12	12	12	
Rotating Neck Jets					4	4	4	3												
Chromatherapy Lighting	●	●	●	○	●	●	●	●			○	○		○	○	●	●	●	●	
Illumatherapy™ Jet Lighting	○	○	○		○	○	○	○								○	○	○	○	
Wave Mode	●	●	●		●	●	●	●								●	●	●	●	
RapidHeat™ Inline Heater	●	●	●	○	●	●	●	●			○	○		○	○	●	●	●	●	
Whisper Technology™	○	○	○		○	○	○	○								○	○	○	○	
J5 LCD Control	○	○	○		○	○	○	○								○	○	○	○	
PURE AIR® BATH																				
Heated Blower	800w	800w	800w	800w	800w	800w	800w	800w		800w	800w	800w		800w	800w	800w	800w	800w	800w	
Bottom Air Injectors	●	●	●		●	●	●	●								●	●	●	●	
Side Air Injectors	●	●	●	●	●	●	●	●		●	●	●		●	●	●	●	●	●	
Chromatherapy Lighting	●	●	●		●	●	●	●								●	●	●	●	
Auto-Dri™ (drain activated)	●	●	●		●	●	●	●								●	●	●	●	
Auto-Dri™ (time activated)				●																
TLC Thermal Lumbar Comfort™	●	●	●	●	●	●	●	●		●	●	●		●	●	●	●	●	●	
Wave Mode	●	●	●		●	●	●	●								●	●	●	●	
J5 LCD Control	○	○	○		○	○	○	○								○	○	○	○	
INSTALLATION OPTIONS																				
Freestanding									●	●			●							
Undermount																●	●	●	●	
Drop-in	●	●	●	●	●	●	●	●		●	●	●		●	●	●	●	●	●	
Alcove				○							○	○		○	○					
Optional Skirt Available				●																
Integral Skirt				○							○	○		○	○					
Tile Flange				○							○	○		○	○					
PAGE NUMBER	16	16	16	17	18	18	18	18	19	20	21	21	22	23	23	24	24	24	24	

	ELARA® 6032 LOW-PROFILE	ELARA® 6036 LOW-PROFILE	ELARA® 6042	ELARA® 6636 LOW-PROFILE	ELARA® 6636	ELARA® 7236	ELARA® 7242	ERA™ DBL-ENDED 6636	ERA™ DBL-ENDED 7142	ERA™ SLIPPER 6032	ERA™ SLIPPER 6934	FINESTRA® 6030	FINESTRA® 6036	FUZION® 7236	FUZION® 7242	FUZION® 7260	FUZION® 7260 DUAL ZONE	FUZION® 6666	GALLERY™ 6243	GALLERY™ 7242	LINEA® 6032	LUNA® 7242	LUXURA® 6030	LUXURA® 6032	LUXURA® 6634	MAJORA® 7242
	60	60	60	66	66	72	72	66	71	60	69	60	60	72	72	72	72	66	62	72	60	72	60	60	66	72
	32	36	42	36	36	36	42	36	42	32	34	30	36	36	42	60	60	66	43	42	32	42	30	32	34	42
	70	72	100	81	91	97	127	63	78	43	56	112	127	99	108	175	175	155	54	89	53	96	44	50	66	75
	End	End	End	End	End	End	End	Center	Center	End	End	End	End	End	Center	Center	Center	Center	End	End	End	Center	End	End	End	End
	•	•	•	•	•	•	•							•	•	•	•	•	•	•	•	•	•	•	•	•
	•	•	•	•	•	•	•					•	•	•	•	•	•	•	•	•	•	•	•	•	•	•
			900w	900w	900w	900w						200w	200w	900w	900w	900w		900w								
			14	14	14	14						10	10	14	11	15		15								
			•	•	•	•						•	•	•	•	•		•								
			•	•	•	•						•	•	•	•	•		•								
			•	•	•	•						•	•	•	•	•		•								
			•	•	•	•						•	•	•	•	•		•								
			•	•	•	•						•	•	•	•	•		•								
			•	•	•	•						•	•	•	•	•		•								
			•	•	•	•						•	•	•	•	•		•								
			•	•	•	•						•	•	•	•	•		•								
			•	•	•	•						•	•	•	•	•		•								
			•	•	•	•						•	•	•	•	•		•								
			•	•	•	•						•	•	•	•	•		•								
			•	•	•	•						•	•	•	•	•		•								
			•	•	•	•						•	•	•	•	•		•								
			•	•	•	•						•	•	•	•	•		•								
			•	•	•	•						•	•	•	•	•		•								
			•	•	•	•						•	•	•	•	•		•								
			•	•	•	•						•	•	•	•	•		•								
			•	•	•	•						•	•	•	•	•		•								
			•	•	•	•						•	•	•	•	•		•								
			•	•	•	•						•	•	•	•	•		•								
			•	•	•	•						•	•	•	•	•		•								
			•	•	•	•						•	•	•	•	•		•								
			•	•	•	•						•	•	•	•	•		•								
			•	•	•	•						•	•	•	•	•		•								
			•	•	•	•						•	•	•	•	•		•								
			•	•	•	•						•	•	•	•	•		•								
			•	•	•	•						•	•	•	•	•		•								
			•	•	•	•						•	•	•	•	•		•								
			•	•	•	•						•	•	•	•	•		•								
			•	•	•	•						•	•	•	•	•		•								
			•	•	•	•						•	•	•	•	•		•								
			•	•	•	•						•	•	•	•	•		•								
			•	•	•	•						•	•	•	•	•		•								
			•	•	•	•						•	•	•	•	•		•								
			•	•	•	•						•	•	•	•	•		•								
			•	•	•	•						•	•	•	•	•		•								
			•	•	•	•						•	•	•	•	•		•								
			•	•	•	•						•	•	•	•	•		•								
			•	•	•	•						•	•	•	•	•		•								
			•	•	•	•						•	•	•	•	•		•								
			•	•	•	•						•	•	•	•	•		•								
			•	•	•	•						•	•	•	•	•		•								
			•	•	•	•						•	•	•	•	•		•								
			•	•	•	•						•	•	•	•	•		•								
			•	•	•	•						•	•	•	•	•		•								
			•	•	•	•						•	•	•	•	•		•								
			•	•	•	•						•	•	•	•	•		•								
			•	•	•	•						•	•	•	•	•		•								
			•	•	•	•						•	•	•	•	•		•								
			•	•	•	•						•	•	•	•	•		•								
			•	•	•	•						•	•	•	•	•		•								
			•	•	•	•						•	•	•	•	•		•								
			•	•	•	•						•	•	•	•	•		•								
			•	•	•	•						•	•	•	•	•		•								
			•	•	•	•						•	•	•	•	•		•								
			•	•	•	•						•	•	•	•	•		•								
			•	•	•	•						•	•	•	•	•		•								
			•	•	•	•						•	•	•	•	•		•								
			•	•	•	•						•	•	•	•	•		•								
			•	•	•	•						•	•	•	•	•		•								
			•	•	•	•						•	•	•	•	•		•								
			•	•	•	•						•	•	•	•	•		•								

MITO™ 6042	MITO™ 7242	NOVA™ 6036	NOVA™ 6042	NOVA™ 7236	NOVA™ 7242	REAL™ 7242	RIVA® 6243	RIVA® 6638	RIVA® 7242	SIA® 6636	SIA® 7242	SIENA™ 6934	SIGNA® 6042	SIGNA® 7242	STELLA™ 6731	TARA™ 6060	TORINO™ 6236	URBINO™ 5633	VERONA® 7133		
																				SPECIFICATIONS	
60	72	60	60	72	72	72	62	66	72	66	72	69	60	72	67	60	62	56	71	Exterior Length (inches)	
42	42	36	42	36	42	42	43	38	42	36	42	34	42	42	31	60	36	33	33	Exterior Width (inches)	
																				Shape	
																				Bathers	
73	95	48	54	56	89	95	54	56	89	76	102	90	75	90	67	79	86	74	70	Max Gallons	
Center	Center	End	End	End	End	Center	End	End	End	Center	Center	Center	Center	Center	End	Center	Center	End	Center	Drain Location	
																				FEATURES	
<input checked="" type="checkbox"/>	<input checked="" type="checkbox"/>	<input checked="" type="checkbox"/>	<input checked="" type="checkbox"/>	<input checked="" type="checkbox"/>	<input checked="" type="checkbox"/>	<input checked="" type="checkbox"/>	<input checked="" type="checkbox"/>	<input checked="" type="checkbox"/>	<input checked="" type="checkbox"/>	<input checked="" type="checkbox"/>	<input checked="" type="checkbox"/>	<input checked="" type="checkbox"/>	<input checked="" type="checkbox"/>	<input checked="" type="checkbox"/>	<input checked="" type="checkbox"/>	<input checked="" type="checkbox"/>	<input checked="" type="checkbox"/>	<input checked="" type="checkbox"/>	<input checked="" type="checkbox"/>	Tru-Level® Base or Adjustable Feet	
<input checked="" type="checkbox"/>	<input checked="" type="checkbox"/>	<input checked="" type="checkbox"/>	<input checked="" type="checkbox"/>	<input checked="" type="checkbox"/>	<input checked="" type="checkbox"/>	<input checked="" type="checkbox"/>	<input checked="" type="checkbox"/>	<input checked="" type="checkbox"/>	<input checked="" type="checkbox"/>	<input checked="" type="checkbox"/>	<input checked="" type="checkbox"/>	<input checked="" type="checkbox"/>	<input checked="" type="checkbox"/>	<input checked="" type="checkbox"/>	<input checked="" type="checkbox"/>	<input checked="" type="checkbox"/>	<input checked="" type="checkbox"/>	<input checked="" type="checkbox"/>	<input checked="" type="checkbox"/>	Slip-Resistant Bottom	
<input checked="" type="checkbox"/>	<input checked="" type="checkbox"/>	<input checked="" type="checkbox"/>	<input checked="" type="checkbox"/>	<input checked="" type="checkbox"/>	<input checked="" type="checkbox"/>	<input checked="" type="checkbox"/>	<input checked="" type="checkbox"/>	<input checked="" type="checkbox"/>	<input checked="" type="checkbox"/>	<input checked="" type="checkbox"/>	<input checked="" type="checkbox"/>	<input checked="" type="checkbox"/>	<input checked="" type="checkbox"/>	<input checked="" type="checkbox"/>	<input checked="" type="checkbox"/>	<input checked="" type="checkbox"/>	<input checked="" type="checkbox"/>	<input checked="" type="checkbox"/>	<input checked="" type="checkbox"/>	Armrest	
<input checked="" type="checkbox"/>	<input checked="" type="checkbox"/>	<input checked="" type="checkbox"/>	<input checked="" type="checkbox"/>	<input checked="" type="checkbox"/>	<input checked="" type="checkbox"/>	<input checked="" type="checkbox"/>	<input checked="" type="checkbox"/>	<input checked="" type="checkbox"/>	<input checked="" type="checkbox"/>	<input checked="" type="checkbox"/>	<input checked="" type="checkbox"/>	<input checked="" type="checkbox"/>	<input checked="" type="checkbox"/>	<input checked="" type="checkbox"/>	<input checked="" type="checkbox"/>	<input checked="" type="checkbox"/>	<input checked="" type="checkbox"/>	<input checked="" type="checkbox"/>	<input checked="" type="checkbox"/>	Handrail	
																				SALON® SPA	
						900w				900w	900w									Heated Blower	
						10				13	13									Total Jets	
						<input checked="" type="checkbox"/>				<input checked="" type="checkbox"/>	<input checked="" type="checkbox"/>									Bottom Air Injectors	
						<input checked="" type="checkbox"/>				<input checked="" type="checkbox"/>	<input checked="" type="checkbox"/>									Chromatherapy Lighting	
						<input checked="" type="checkbox"/>				<input checked="" type="checkbox"/>	<input checked="" type="checkbox"/>									Illumatherapy™ Jet Lighting	
						<input checked="" type="checkbox"/>				<input checked="" type="checkbox"/>	<input checked="" type="checkbox"/>									Auto-Dri™ (drain activated)	
						<input checked="" type="checkbox"/>				<input checked="" type="checkbox"/>	<input checked="" type="checkbox"/>									Wave Mode	
						<input checked="" type="checkbox"/>				<input checked="" type="checkbox"/>	<input checked="" type="checkbox"/>									RapidHeat™ Inline Heater	
						<input checked="" type="checkbox"/>				<input checked="" type="checkbox"/>	<input checked="" type="checkbox"/>									Whisper Technology™	
						<input checked="" type="checkbox"/>				<input checked="" type="checkbox"/>	<input checked="" type="checkbox"/>									J5 LCD Control	
																				WHIRLPOOL	
8	8	8	8	8	8	10	8	8	8	13	13		8	8						Total Jets	
4	4	4	4	4	4	4	4	4	4	4	4		4	4						TargetPro™ Jets	
																				SlimPro® Jets	
4	4	4	4	4	4	2	4	4	4	9	9		4	4						AccuPro™ Jets	
						4														Rotating Neck Jets	
<input checked="" type="checkbox"/>	<input checked="" type="checkbox"/>	<input checked="" type="checkbox"/>	<input checked="" type="checkbox"/>	<input checked="" type="checkbox"/>	<input checked="" type="checkbox"/>	<input checked="" type="checkbox"/>	<input checked="" type="checkbox"/>	<input checked="" type="checkbox"/>	<input checked="" type="checkbox"/>	<input checked="" type="checkbox"/>	<input checked="" type="checkbox"/>		<input checked="" type="checkbox"/>	<input checked="" type="checkbox"/>						Chromatherapy Lighting	
						<input checked="" type="checkbox"/>				<input checked="" type="checkbox"/>	<input checked="" type="checkbox"/>									Illumatherapy™ Jet Lighting	
						<input checked="" type="checkbox"/>				<input checked="" type="checkbox"/>	<input checked="" type="checkbox"/>									Wave Mode	
<input checked="" type="checkbox"/>	<input checked="" type="checkbox"/>	<input checked="" type="checkbox"/>	<input checked="" type="checkbox"/>	<input checked="" type="checkbox"/>	<input checked="" type="checkbox"/>	<input checked="" type="checkbox"/>	<input checked="" type="checkbox"/>	<input checked="" type="checkbox"/>	<input checked="" type="checkbox"/>	<input checked="" type="checkbox"/>	<input checked="" type="checkbox"/>		<input checked="" type="checkbox"/>	<input checked="" type="checkbox"/>						RapidHeat™ Inline Heater	
						<input checked="" type="checkbox"/>				<input checked="" type="checkbox"/>	<input checked="" type="checkbox"/>									Whisper Technology™	
						<input checked="" type="checkbox"/>				<input checked="" type="checkbox"/>	<input checked="" type="checkbox"/>									J5 LCD Control	
																				PURE AIR® BATH	
800w	800w	800w	800w	800w	800w	800w	800w	800w	800w	800w	800w		800w	800w						Heated Blower	
<input checked="" type="checkbox"/>	<input checked="" type="checkbox"/>	<input checked="" type="checkbox"/>	<input checked="" type="checkbox"/>	<input checked="" type="checkbox"/>	<input checked="" type="checkbox"/>	<input checked="" type="checkbox"/>	<input checked="" type="checkbox"/>	<input checked="" type="checkbox"/>	<input checked="" type="checkbox"/>	<input checked="" type="checkbox"/>	<input checked="" type="checkbox"/>		<input checked="" type="checkbox"/>	<input checked="" type="checkbox"/>						Bottom Air Injectors	
						<input checked="" type="checkbox"/>				<input checked="" type="checkbox"/>	<input checked="" type="checkbox"/>		<input checked="" type="checkbox"/>	<input checked="" type="checkbox"/>						Side Air Injectors	
						<input checked="" type="checkbox"/>				<input checked="" type="checkbox"/>	<input checked="" type="checkbox"/>		<input checked="" type="checkbox"/>	<input checked="" type="checkbox"/>						Chromatherapy Lighting	
						<input checked="" type="checkbox"/>				<input checked="" type="checkbox"/>	<input checked="" type="checkbox"/>		<input checked="" type="checkbox"/>	<input checked="" type="checkbox"/>						Auto-Dri™ (drain activated)	
						<input checked="" type="checkbox"/>				<input checked="" type="checkbox"/>	<input checked="" type="checkbox"/>		<input checked="" type="checkbox"/>	<input checked="" type="checkbox"/>						Auto-Dri™ (time activated)	
						<input checked="" type="checkbox"/>				<input checked="" type="checkbox"/>	<input checked="" type="checkbox"/>		<input checked="" type="checkbox"/>	<input checked="" type="checkbox"/>						TLC Thermal Lumbar Comfort™	
						<input checked="" type="checkbox"/>				<input checked="" type="checkbox"/>	<input checked="" type="checkbox"/>		<input checked="" type="checkbox"/>	<input checked="" type="checkbox"/>						Wave Mode	
						<input checked="" type="checkbox"/>				<input checked="" type="checkbox"/>	<input checked="" type="checkbox"/>		<input checked="" type="checkbox"/>	<input checked="" type="checkbox"/>						J5 LCD Control	
																				INSTALLATION OPTIONS	
												<input checked="" type="checkbox"/>			<input checked="" type="checkbox"/>		<input checked="" type="checkbox"/>	<input checked="" type="checkbox"/>	<input checked="" type="checkbox"/>	Freestanding	
<input checked="" type="checkbox"/>	<input checked="" type="checkbox"/>	<input checked="" type="checkbox"/>	<input checked="" type="checkbox"/>	<input checked="" type="checkbox"/>	<input checked="" type="checkbox"/>	<input checked="" type="checkbox"/>	<input checked="" type="checkbox"/>	<input checked="" type="checkbox"/>	<input checked="" type="checkbox"/>	<input checked="" type="checkbox"/>	<input checked="" type="checkbox"/>		<input checked="" type="checkbox"/>	<input checked="" type="checkbox"/>		<input checked="" type="checkbox"/>	<input checked="" type="checkbox"/>	<input checked="" type="checkbox"/>	<input checked="" type="checkbox"/>	Undermount	
		<input checked="" type="checkbox"/>	<input checked="" type="checkbox"/>	<input checked="" type="checkbox"/>	<input checked="" type="checkbox"/>	<input checked="" type="checkbox"/>	<input checked="" type="checkbox"/>	<input checked="" type="checkbox"/>	<input checked="" type="checkbox"/>	<input checked="" type="checkbox"/>	<input checked="" type="checkbox"/>		<input checked="" type="checkbox"/>	<input checked="" type="checkbox"/>		<input checked="" type="checkbox"/>	<input checked="" type="checkbox"/>	<input checked="" type="checkbox"/>	<input checked="" type="checkbox"/>	Drop-in	
		<input checked="" type="checkbox"/>	<input checked="" type="checkbox"/>	<input checked="" type="checkbox"/>	<input checked="" type="checkbox"/>	<input checked="" type="checkbox"/>	<input checked="" type="checkbox"/>	<input checked="" type="checkbox"/>	<input checked="" type="checkbox"/>	<input checked="" type="checkbox"/>	<input checked="" type="checkbox"/>		<input checked="" type="checkbox"/>	<input checked="" type="checkbox"/>		<input checked="" type="checkbox"/>	<input checked="" type="checkbox"/>	<input checked="" type="checkbox"/>	<input checked="" type="checkbox"/>	Alcove	
		<input checked="" type="checkbox"/>	<input checked="" type="checkbox"/>	<input checked="" type="checkbox"/>	<input checked="" type="checkbox"/>	<input checked="" type="checkbox"/>	<input checked="" type="checkbox"/>	<input checked="" type="checkbox"/>	<input checked="" type="checkbox"/>	<input checked="" type="checkbox"/>	<input checked="" type="checkbox"/>		<input checked="" type="checkbox"/>	<input checked="" type="checkbox"/>		<input checked="" type="checkbox"/>	<input checked="" type="checkbox"/>	<input checked="" type="checkbox"/>	<input checked="" type="checkbox"/>	Optional Skirt Available	
		<input checked="" type="checkbox"/>	<input checked="" type="checkbox"/>	<input checked="" type="checkbox"/>	<input checked="" type="checkbox"/>	<input checked="" type="checkbox"/>	<input checked="" type="checkbox"/>	<input checked="" type="checkbox"/>	<input checked="" type="checkbox"/>	<input checked="" type="checkbox"/>	<input checked="" type="checkbox"/>		<input checked="" type="checkbox"/>	<input checked="" type="checkbox"/>		<input checked="" type="checkbox"/>	<input checked="" type="checkbox"/>	<input checked="" type="checkbox"/>	<input checked="" type="checkbox"/>	Integral Skirt	
		<input checked="" type="checkbox"/>	<input checked="" type="checkbox"/>	<input checked="" type="checkbox"/>	<input checked="" type="checkbox"/>	<input checked="" type="checkbox"/>	<input checked="" type="checkbox"/>	<input checked="" type="checkbox"/>	<input checked="" type="checkbox"/>	<input checked="" type="checkbox"/>	<input checked="" type="checkbox"/>		<input checked="" type="checkbox"/>	<input checked="" type="checkbox"/>		<input checked="" type="checkbox"/>	<input checked="" type="checkbox"/>	<input checked="" type="checkbox"/>	<input checked="" type="checkbox"/>	Tile Flange	
34	34	35	35	35	35	36	37	37	37	38	38	39	40	40	41	42	43	44	45	PAGE NUMBER	

JACUZZI® BRAND

Jacuzzi Group Worldwide is a global organization with original product patents and thousands of employees. Valvasone, Italy, the Jacuzzi family's home of origin, is a key center of this worldwide network. Jacuzzi Luxury Bath is headquartered near Los Angeles in Chino Hills, California.

Globally known for luxury, Jacuzzi® Brand zealously researches science and technology advances to design and develop beautiful products for contemporary lifestyles. Since 1956, when Candido Jacuzzi commercialized the first at-home hydrotherapy pump, every product made by Jacuzzi has been created for the same reason: to provide a rejuvenating and refreshing hydrotherapeutic experience that revitalizes both body and spirit.

60
YEARS
OF HYDROTHERAPY



WARRANTY

Jacuzzi® baths are backed by one of the most comprehensive warranties in the industry and a nationwide service network. Jacuzzi Luxury Bath's Limited Lifetime Warranty is assurance that your investment will perform reliably for years to come.

13925 CITY CENTER DR., SUITE 200
CHINO HILLS, CA 91709 / U.S.A.
(800) 288-4002

www.jacuzziluxurybath.com

© 2015 Jacuzzi Inc. All rights reserved. Jacuzzi® is a registered trademark of Jacuzzi Inc. All other brands, product names, company names, trade names and trademarks used are the property of their respective owners. Jacuzzi may add to, change or remove any part of these materials at any time, without notice. Reproduction in whole or in part without written permission is prohibited. International products may be configured differently to meet local electrical requirements. Dimensions are approximate.

LQ32000 11/15



WATER THAT MOVES YOU™