

CHROMTECH/1.0

**FLOOR
GRES** 

MADE IN FLORIM

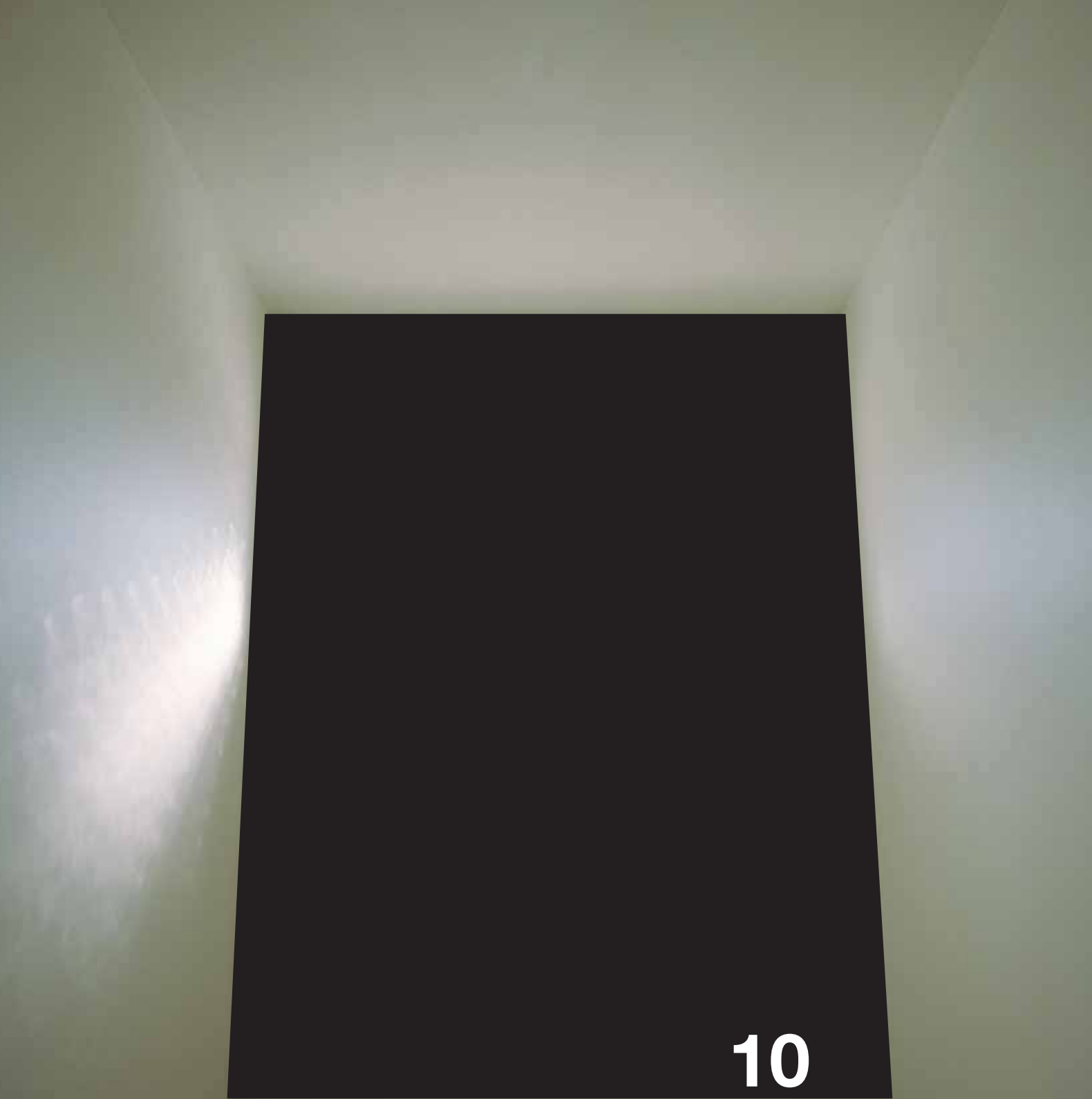

10

COLORS

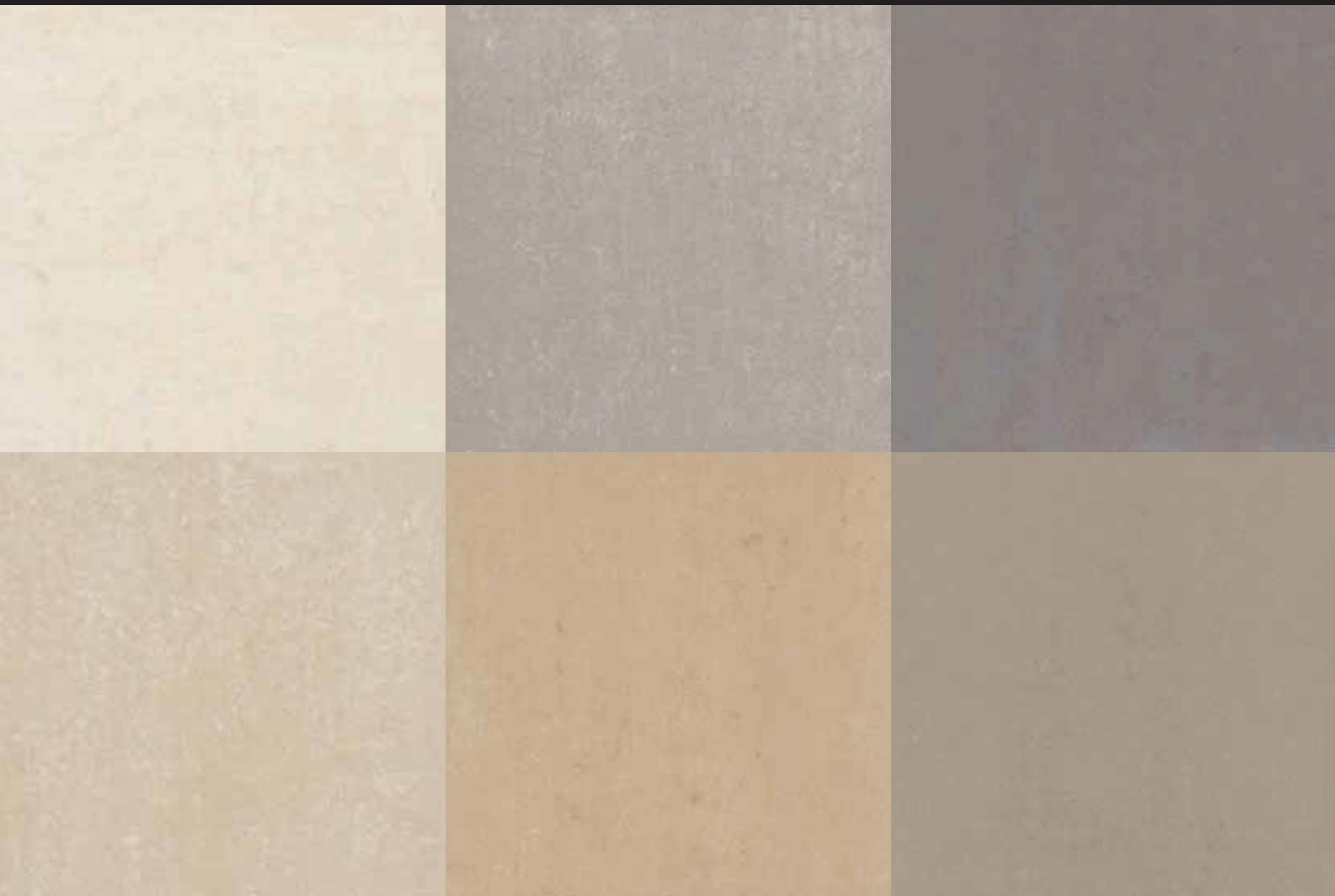



5/COOL



5/WARM

60x120 cm.
the new big size.

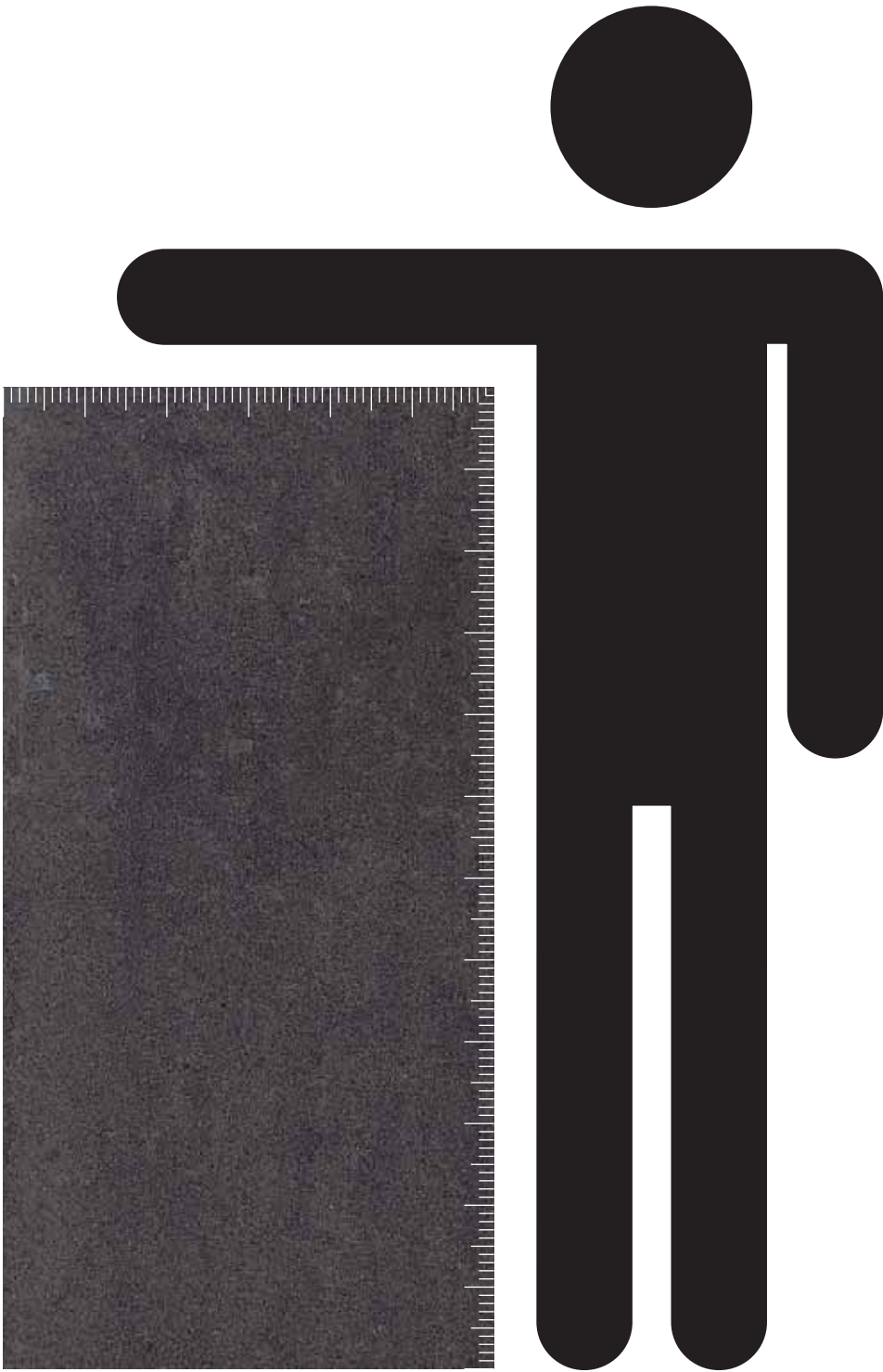



Floor Gres redesigns Chromte



ech with today's perspectives.

Floor Gres ripensa Chromtech con gli occhi di oggi. Al centro del mondo Floor Gres è sempre il progettista. Obiettivo è arricchire il cuore originario del progetto di nuove potenzialità espressive, al servizio dell'architettura contemporanea. / **Floor Gres redesigns Chromtech with today's perspectives.** The designer is always the star at the center of the stage. The goal is to enrich the original heart of the project with new eloquent potentials placed at the disposal of contemporary architecture. / **Floor Gres repense Chromtech avec le regard d'aujourd'hui.** Au centre du monde, Floor Gres est toujours le projeteur. L'objectif est d'enrichir le coeur originel du projet de nouvelles possibilités d'expression, au service de l'architecture contemporaine. / **Floor Gres präsentiert eine Neuinterpretation von Chromtech im Licht der Aktualität.** In der Welt von Floor Gres steht stets der Designer im Mittelpunkt. Ziel ist es, die Kernidee des Projekts durch neue Ausdrucksformen zu bereichern, die der modernen Architektur angepasst sind. / **Floor Gres rediseña Chromtech con los ojos de hoy.** El protagonista del mundo Floor Gres siempre es el proyectista. El objetivo es enriquecer el núcleo original del proyecto con nuevas posibilidades expresivas, al servicio de la arquitectura contemporánea.





TAKING
PICTURE
HOLDING
BREATH



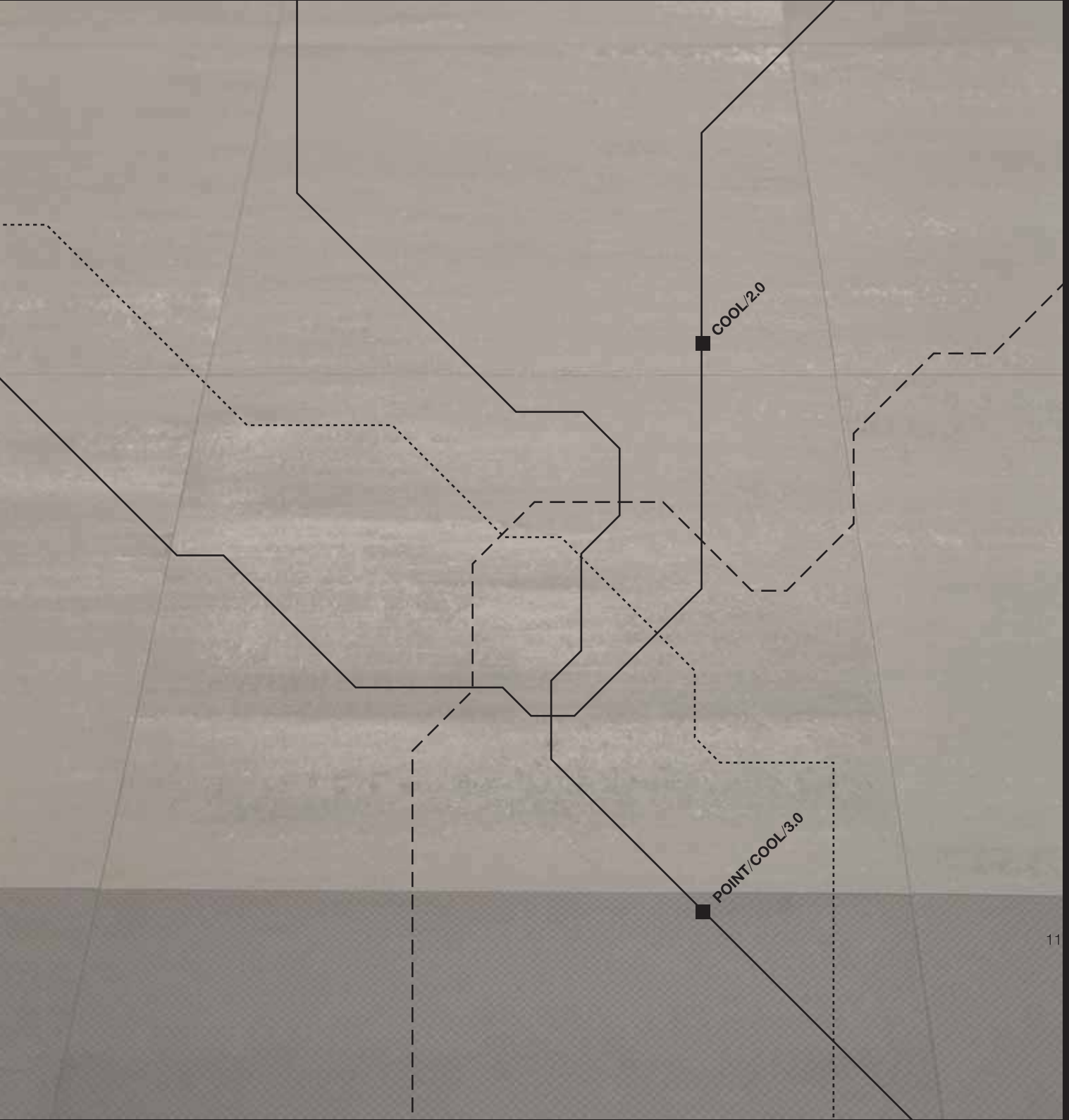

COOL/2.0

POINT/COOL/3.0

Neutral colours to dr

ess the architecture.

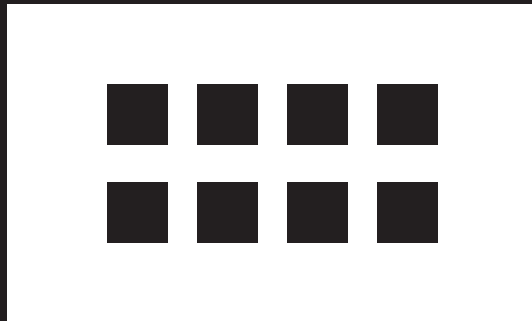

Tinte neutre per vestire l'architettura. Pensata per l'architettura contemporanea, Chromtech/1.0 permette di dosare il colore, di pareti e pavimenti, valorizzando i volumi dell'architettura.

Neutral colours to dress the architecture. Designed for contemporary architecture, Chromtech/1.0 lets you measure out the amount of wall and floor color so as to enhance the value of architecture's volume and space. / **Teintes neutres pour habiller l'architecture.** Pensé pour l'architecture contemporaine, Chromtech/1.0 permet de doser la couleur, de murs et de sols, en mettant en valeur les volumes de l'architecture. / **Neutrale Farben für die Architektur.** Für die moderne Architektur entwickelt, ermöglicht Chromtech/1.0 die Dosierung der Farbe von Wänden und Böden und somit die effektvolle Hervorhebung der Volumen in der architektonischen Gestaltung. / **Colores neutros para engalanar la arquitectura.** Concebida pensando en la arquitectura contemporánea, Chromtech/1.0 permite dosificar el color de paredes y pavimentos dando realce a los volúmenes de la arquitectura.

Walls







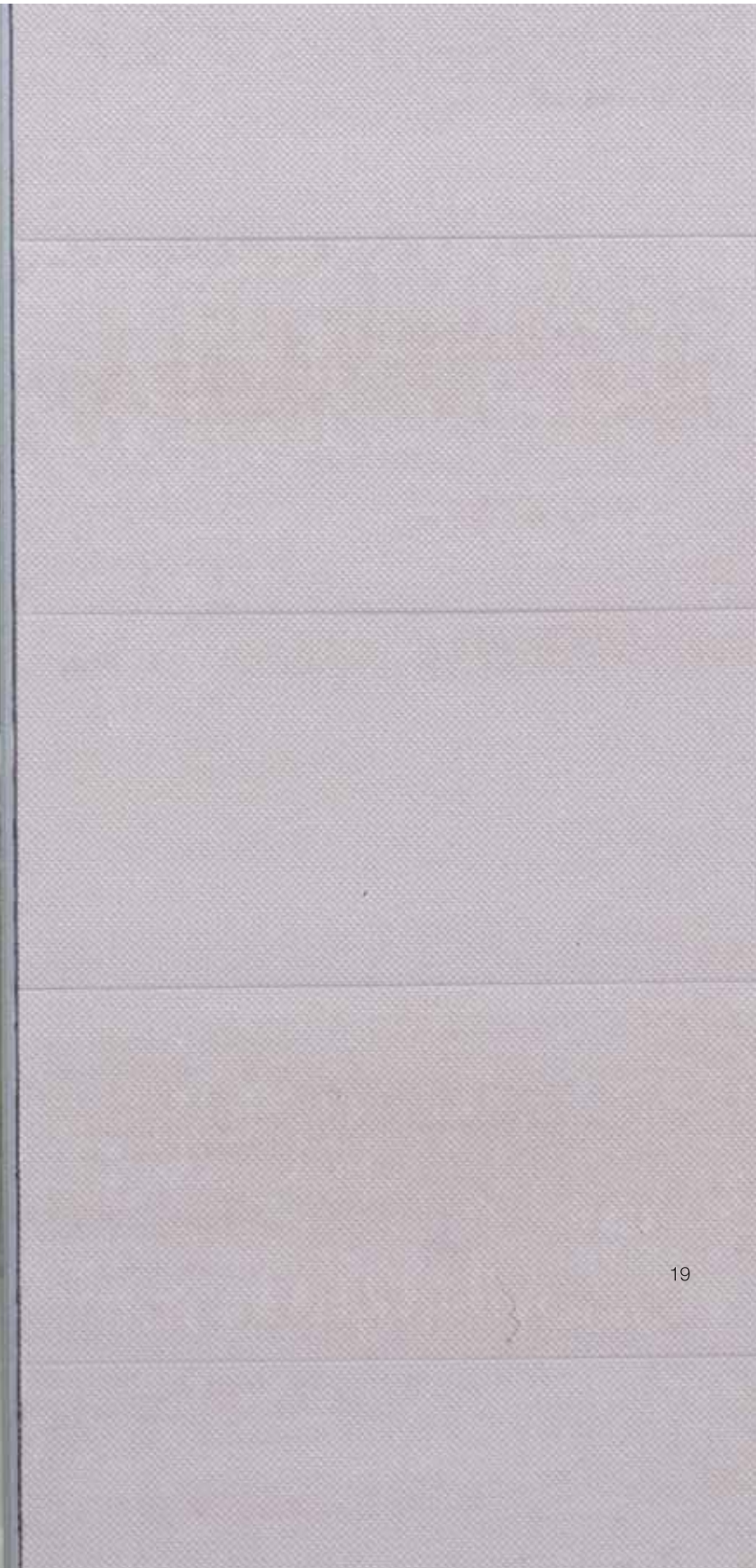
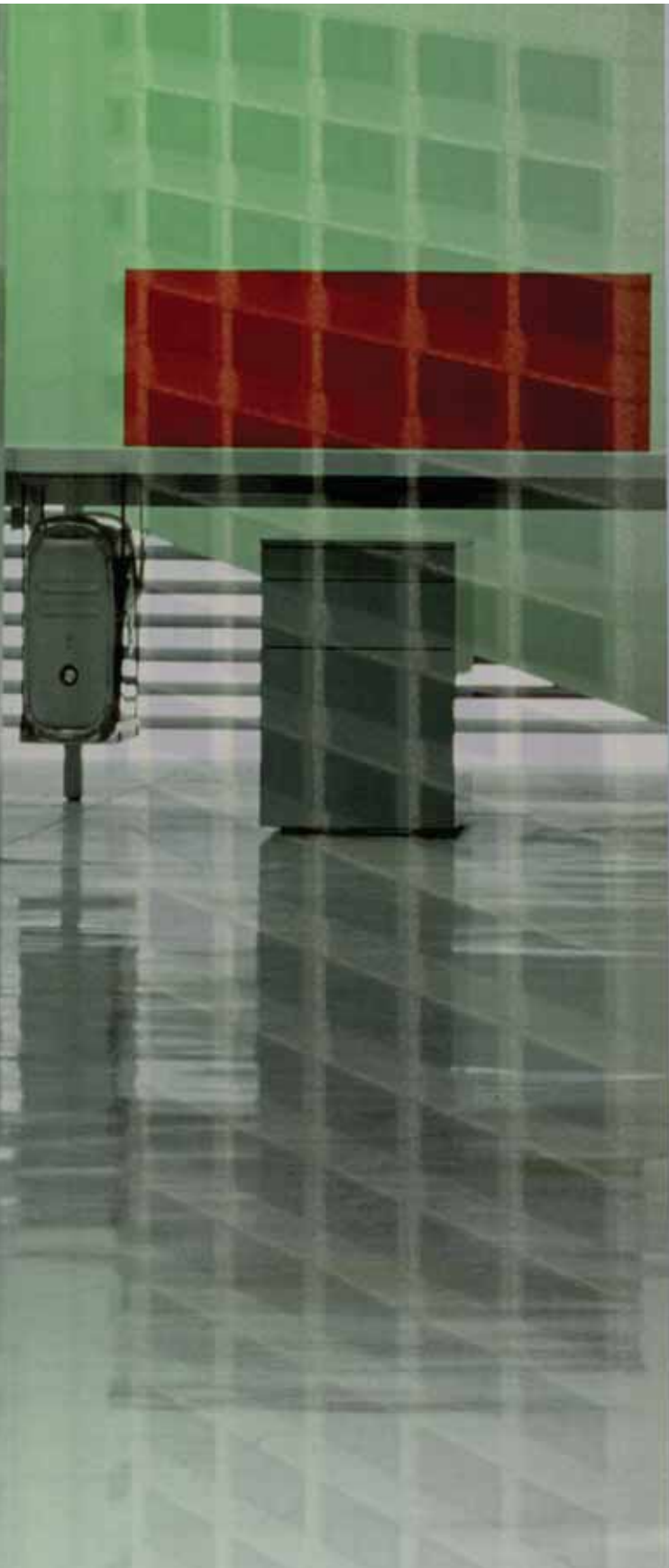

The path of the res



search is the color.



COOL/1.0

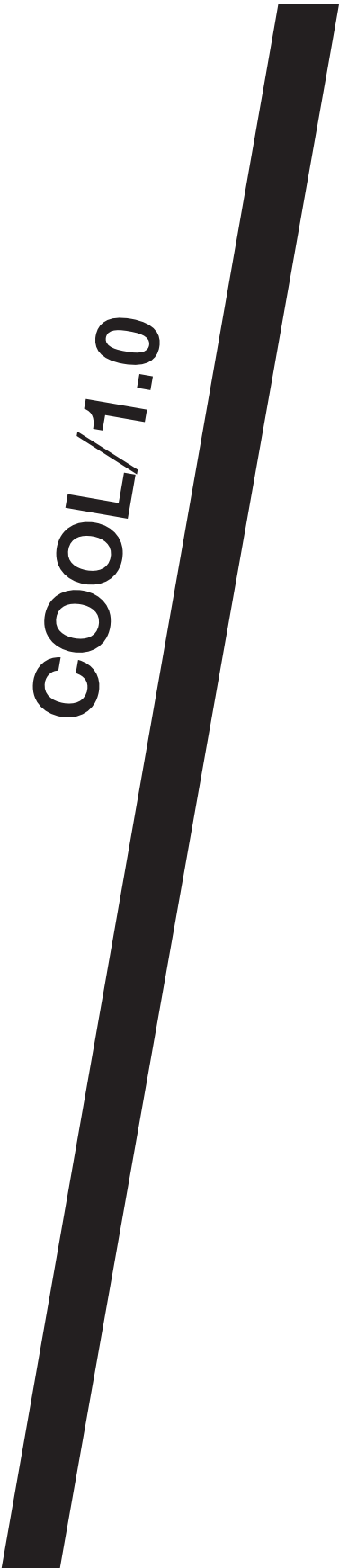





A photograph of a modern architectural interior. The scene is dominated by a large glass wall on the left and a staircase with a glass railing on the right. The floor is highly reflective, mirroring the surrounding environment. The lighting is soft and even, highlighting the clean lines and materials of the space. The overall atmosphere is one of transparency and modernity.

Il percorso di ricerca é il colore. Capire il valore delle sfumature. Cogliere l'importanza della neutralità nell'architettura contemporanea. 10 gradazioni di colore, suddivise in 5 toni caldi e 5 toni freddi.

The path of the research is the color. Understanding the value of shades. Grasping the importance of neutrality in contemporary architecture. 10 shades of color divided into 5 warm tones and 5 cool tones.

Le parcours de recherche est la couleur.

Comprendre la valeur des nuances. Cueillir l'importance de la neutralité dans l'architecture contemporaine. 10 gradations de couleur, divisées en 5 tons chauds et 5 tons froids.

Der Forschungsweg ist die Farbe. Die Bedeutung der Nuancen erfassen. Den Sinn der Neutralität in der modernen Architektur verstehen. 10 Farbstufen, die in 5 warme und 5 kalte Töne aufgeteilt sind.

La investigación sigue el camino del color. Comprender el valor de los matices. Captar la importancia de lo neutro en la arquitectura contemporánea. Diez gradaciones de color, subdivididas en cinco tonos cálidos y cinco tonos fríos.

Obsess

the way

colors

erwin g

orld's

s.





Osservare i colori del mondo. Ascoltare le esigenze del progettista. Costruire due gradazioni di colori caldi e freddi, perfettamente bilanciate. / **Observing the world's colors. Listening to the designer's needs.** Producing two shades of perfectly balanced warm and cool colors. / **Observer les couleurs du monde. Écouter les exigences du projeteur.** Créer deux gradations de couleurs chaudes et froides, parfaitement équilibrées. / **Die Farben der Welt betrachten. Die Bedürfnisse des Designers wahrnehmen.** Zwei Farbstufen entwickeln, die aus perfekt ausgewogenen warmen und kalten Farbtönen bestehen. / **Observar los colores del mundo. Prestar atención a las necesidades del proyectista.** Crear dos gradaciones, de colores cálidos y fríos, perfectamente equilibradas.

WARM/3.0



Walk safely

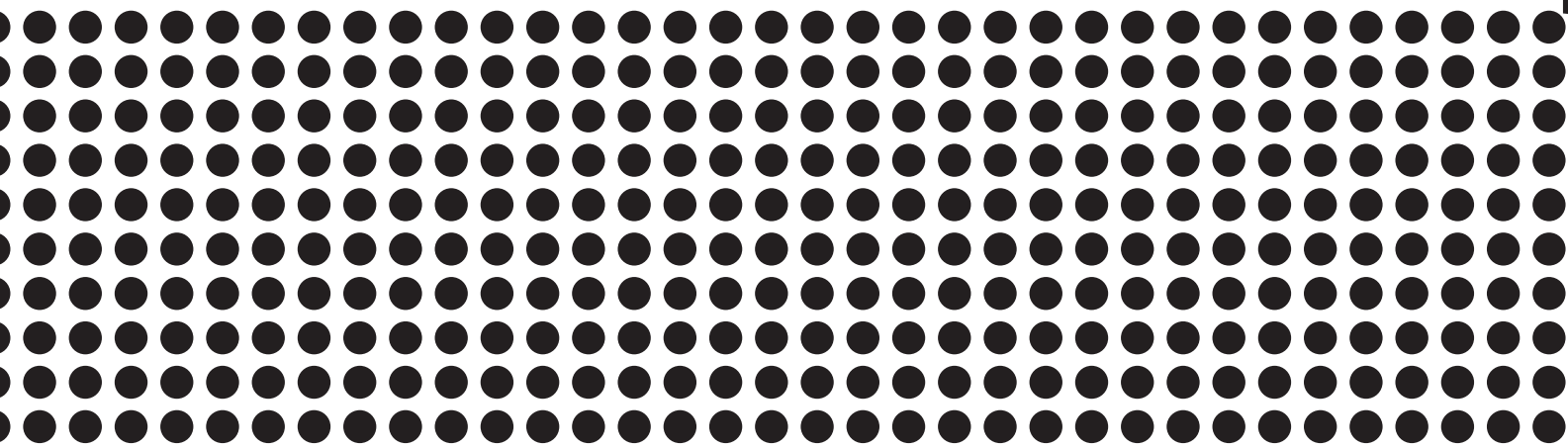

y on Point.

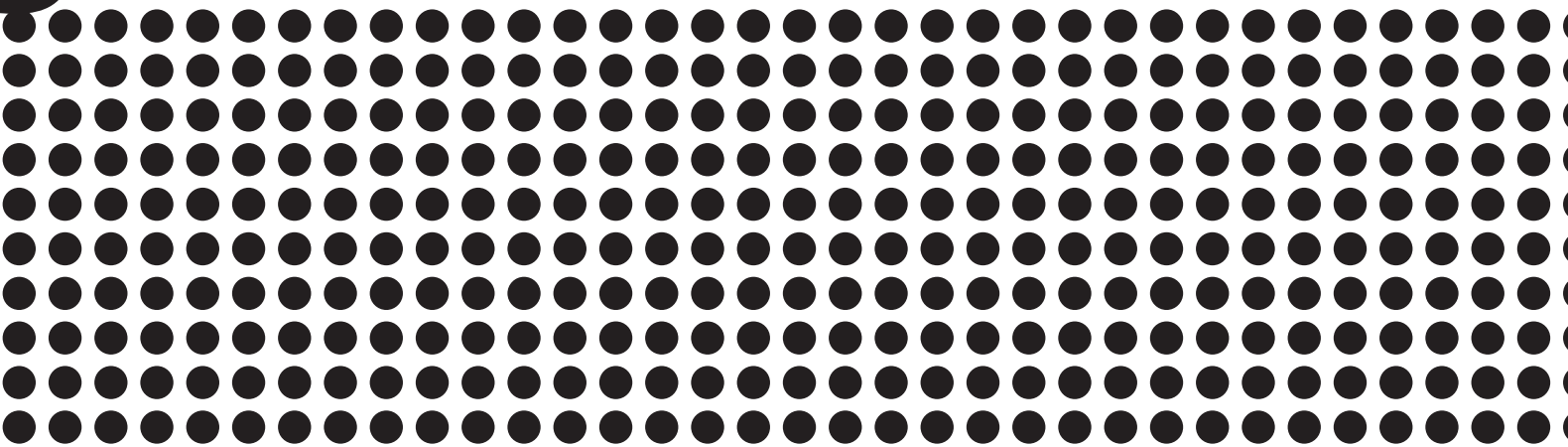



JAPANESE RESTAURANT

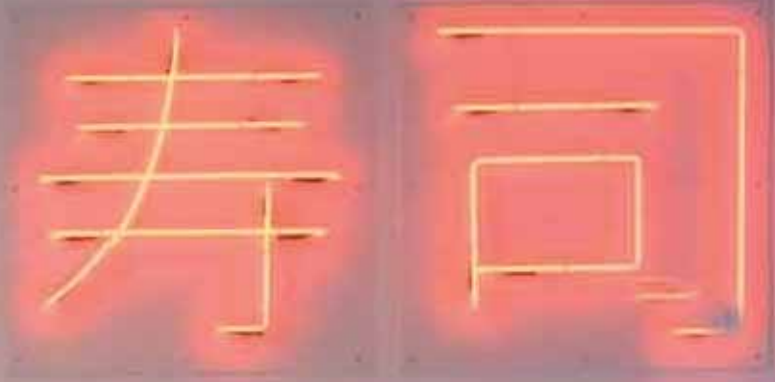

POINT/



Cammina sicuro su Point. La superficie antiscivolo diventa elemento di design. La geometria tridimensionale dei rilievi Point è un'opportunità da utilizzare per esigenze tecniche ed estetiche. / **Walk safely on Point.** The non-skid surface becomes a design element. The 3D pattern of the Point reliefs is an opportunity to be seized and used for technical and aesthetic needs. / **Marchez en toute tranquillité sur Point.** La surface anti-dérapante devient un élément de design. La géométrie tridimensionnelle des reliefs Point est une opportunité à utiliser pour répondre à des exigences techniques et esthétiques. / **Sicheres Gehen auf Point.** Die rutschhemmende Oberfläche wird zum Designelement. Die dreidimensionale Geometrie der Reliefstruktur von Point bietet die Möglichkeit, technische und ästhetische Anforderungen zu erfüllen. / **Camina con seguridad sobre Point.** La superficie antideslizante se convierte en elemento de diseño. El carácter geométrico tridimensional de los relieves Point constituye una oportunidad que hay que aprovechar para satisfacer exigencias técnicas y estéticas.

/COOL/3.0



JAPANESE RES

STAURANT COOL/5.0

Una lunga storia di affidabilità. Chromtech/1.0 è collaudato da 15 anni di progetti importanti, milioni di mq posati in ambienti a traffico elevato: pavimenti, pareti, interni ed esterni, anche in condizioni estreme.

/ A long history of reliability. Chromtech/1.0 has been tested for over 15 years in prestigious projects, millions of sq.mt. laid in heavy traffic areas: floors, walls, indoors, outdoors, even in extreme conditions.

/ Une longue histoire de fiabilité. Chromtech/1.0 vante 15 ans d'expérience au travers de projets importants des millions de m2 posés dans des milieux à passage intense : sols, parois, intérieurs et extérieurs, parfois même dans des conditions les plus extrêmes.

/ Eine lange Geschichte der Zuverlässigkeit. Chromtech/1.0 ist seit 15 Jahren durch bedeutende Objekte geprüft, Millionen von Quadratmetern sind in Bereichen mit hoher Beanspruchung verlegt: Bodenflächen, Wandflächen innen und aussen, auch für extreme Bedingungen.

/ Una larga historia de fiabilidad. Chromtech/1.0 ha sido experimentado a lo largo de 15 años en multitud de proyectos importantes; millones de mq colocados en ambientes sometidos a un tránsito intenso: pavimentos, paredes, interiores y exteriores, incluso en condiciones extremas.

A long story of

of reliability.



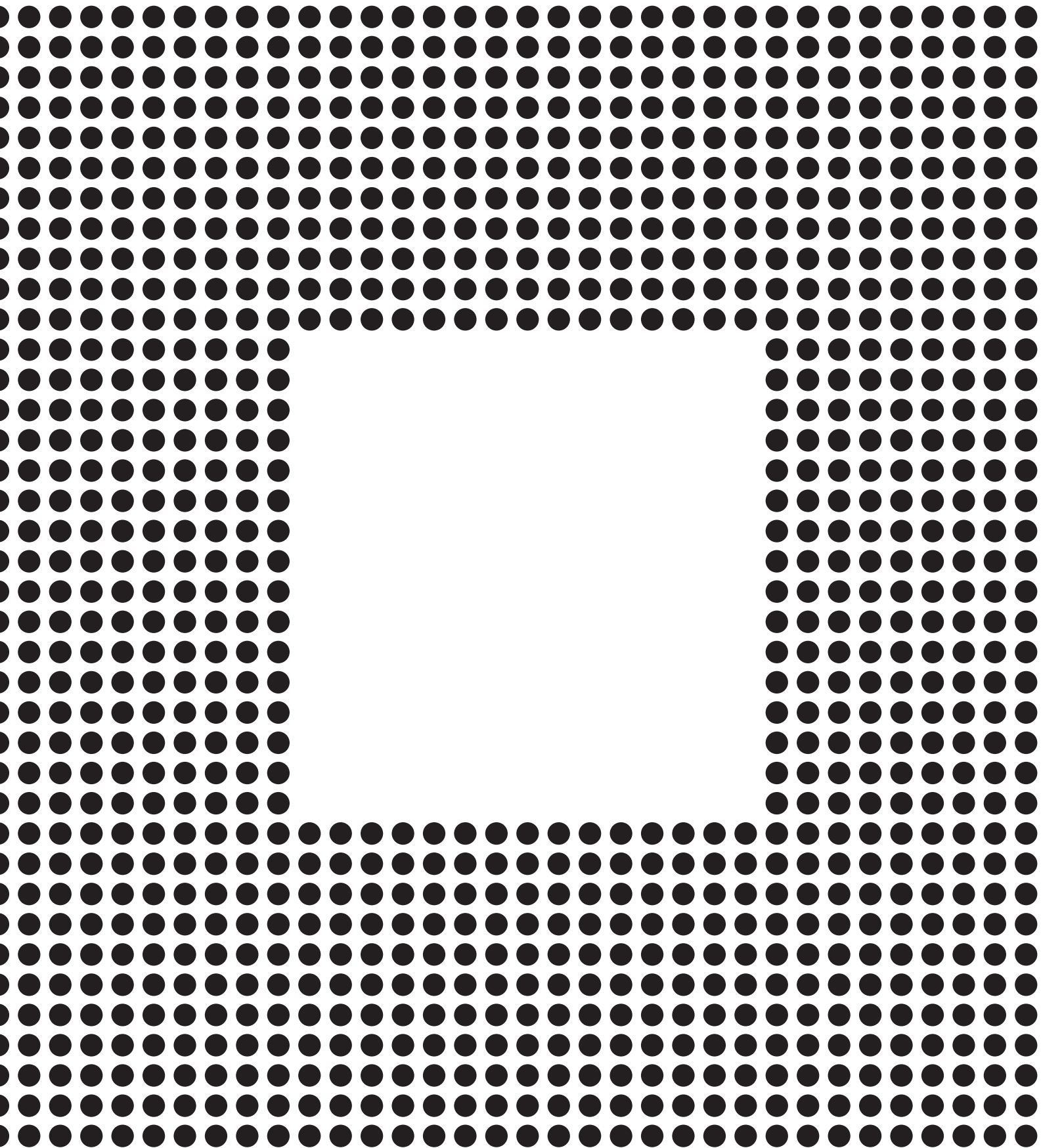

MATTE+POINT



WARM/4.0



POINT/WARM/4.0

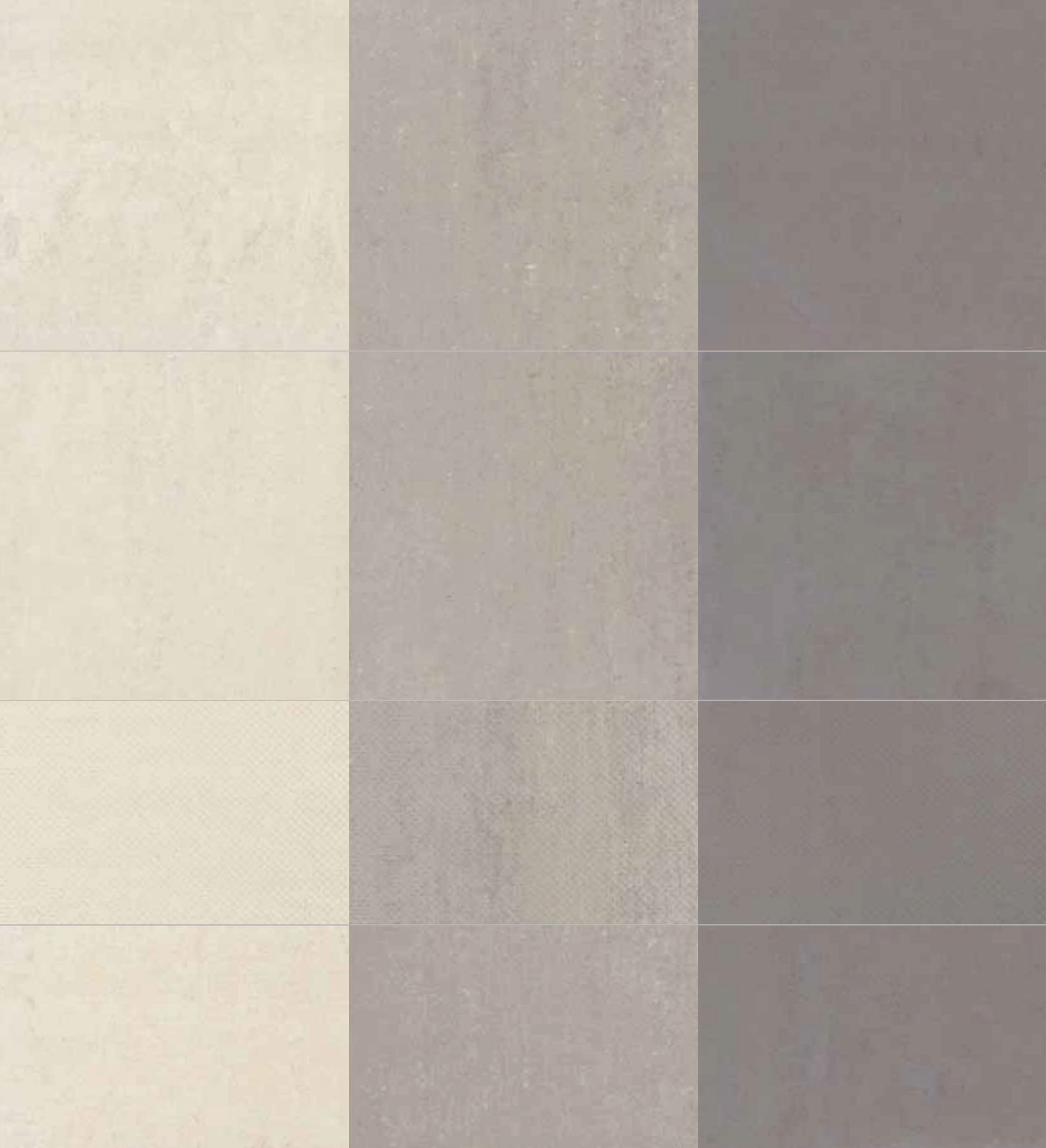

COOL/1.0

COOL/2.0*
***ROC ARGENT**

COOL/3.0

*In accordo con il documento BGR 181 (Fußböden in Arbeitsräumen und Arbeitsbereichen mit Rutschgefahr, aktualisierte Fassung Oktober 2003) Florim consiglia l'utilizzo di questo materiale per pavimentazioni interne o rivestimenti interni e/o esterni. *In accordance with document BGR 181 (Fußböden in Arbeitsräumen und Arbeitsbereichen mit Rutschgefahr, aktualisierte Fassung Oktober 2003), Florim recommends this material to be used on indoor floors or indoor and/or outdoor wall coverings. *Conformément au document BGR 181 (Fußböden in Arbeitsräumen und Arbeitsbereichen mit Rutschgefahr, aktualisierte Fassung Oktober 2003), la société Florim recommande d'utiliser ce matériau pour les revêtements de sol intérieur ou les revêtements muraux intérieurs / extérieurs. *Dem Dokument BGR 181 (Fußböden in Arbeitsräumen und Arbeitsbereichen mit Rutschgefahr, aktualisierte Fassung Oktober 2003) entsprechend, empfiehlt Florim die Verwendung dieses Materials für die Fußbodenverlegung im Innenbereich oder Wandverkleidung im Innen- und/oder Außenbereich. *De acuerdo con el documento BGR 181 (Fußböden in Arbeitsräumen und Arbeitsbereichen mit Rutschgefahr, aktualisierte Fassung Oktober 2003) Florim aconseja el uso de este material para suelos internos o revestimientos internos y/o externos. *В соответствии с документом BGR 181 (Fußböden in Arbeitsräumen und Arbeitsbereichen mit Rutschgefahr, aktualisierte Fassung Oktober 2003) компания Florim рекомендует использовать настоящий материал для напольного покрытия полов внутренних помещений или для внутренней и/или внешней настенной облицовки.



NATURALE/SQUADRATO/R10*

MATTE/SQUARED/R10
NATUREL/EQUARRI/R10
MATT/VIERKANTIG/R10
MATE/ESCUADRADO/R10
НАТУРАЛЬНЫЙ/ОБТЕСАННЫЙ/R10



POINT/SQUADRATO/R11/CLASSE C

POINT/SQUARED/R11/CLASS C
POINT/EQUARRI/R11/CLASSE C
POINT/VIERKANTIG/R11/GRUPPE C
POINT/ESCUADRADO/R11/CLASE C
POINT/ОБТЕСАННЫЙ/R11/КЛАСС C



LEVIGATO/SQUADRATO

POLISHED/SQUARED
POLI/EQUARRI
POLIERT/VIERKANTIG
PULIDO/ESCUADRADO
ПОЛИРОВАННЫЙ/ОБТЕСАННЫЙ

COOL/4.0*
*CHARBON

COOL/5.0

Product Certification
BUREAU VERITAS
Certification



N° 317/001E

Recycled Content 40%

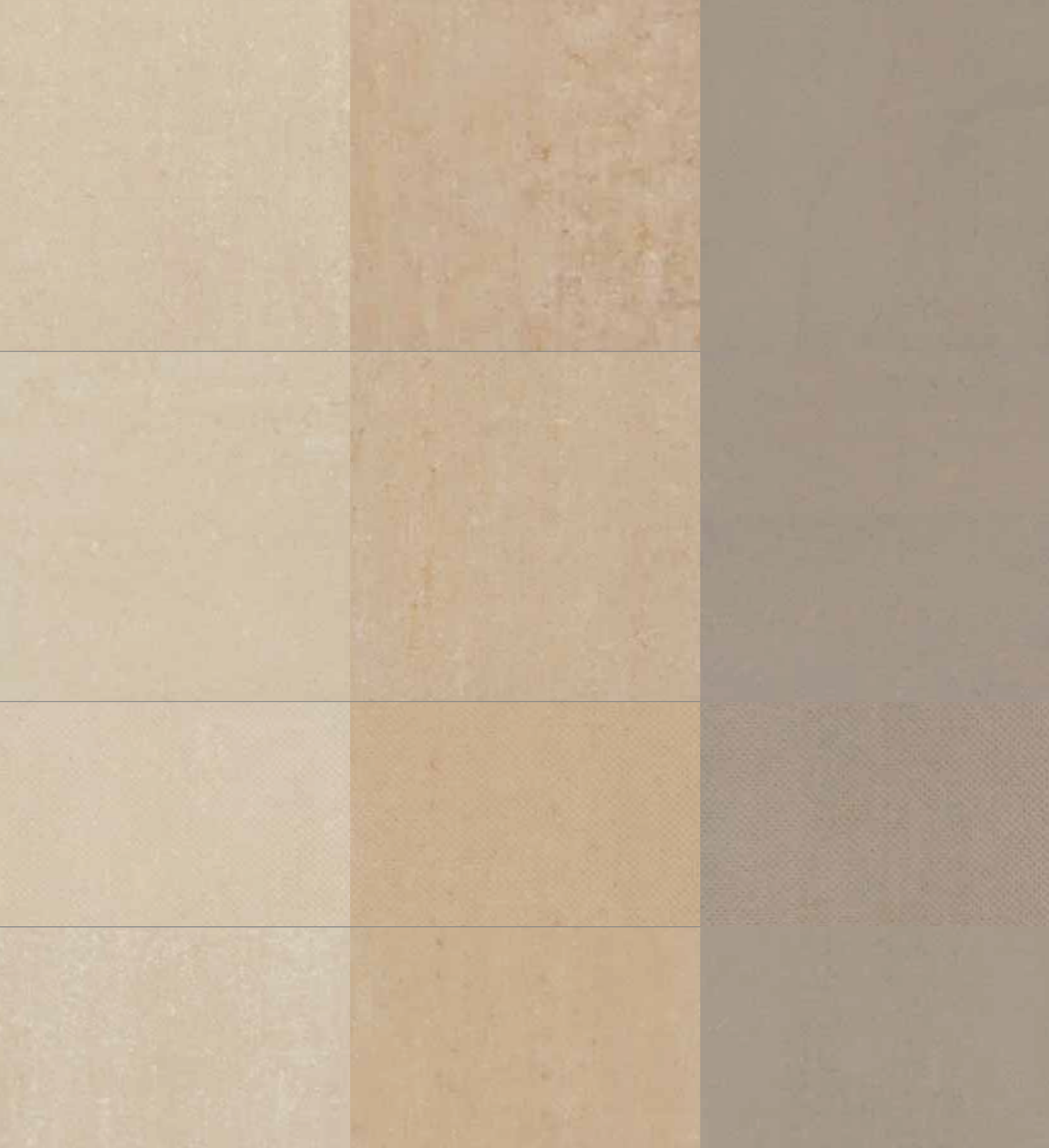

WARM/1.0
*PEBBLE

WARM/2.0*
*HAUTE VILLE

WARM/3.0

*In accordo con il documento BGR 181 (Fußböden in Arbeitsräumen und Arbeitsbereichen mit Rutschgefahr, aktualisierte Fassung Oktober 2003) Florim consiglia l'utilizzo di questo materiale per pavimentazioni interne o rivestimenti interni e/o esterni. *In accordance with document BGR 181 (Fußböden in Arbeitsräumen und Arbeitsbereichen mit Rutschgefahr, aktualisierte Fassung Oktober 2003), Florim recommends this material to be used on indoor floors or indoor and/or outdoor wall coverings. *Conformément au document BGR 181 (Fußböden in Arbeitsräumen und Arbeitsbereichen mit Rutschgefahr, aktualisierte Fassung Oktober 2003), la société Florim recommande d'utiliser ce matériau pour les revêtements de sol intérieur ou les revêtements muraux intérieurs / extérieurs. *Dem Dokument BGR 181 (Fußböden in Arbeitsräumen und Arbeitsbereichen mit Rutschgefahr, aktualisierte Fassung Oktober 2003) entsprechend, empfiehlt Florim die Verwendung dieses Materials für die Fußbodenverlegung im Innenbereich oder Wandverkleidung im Innen- und/oder Außenbereich. *De acuerdo con el documento BGR 181 (Fußböden in Arbeitsräumen und Arbeitsbereichen mit Rutschgefahr, aktualisierte Fassung Oktober 2003) Florim aconseja el uso de este material para suelos internos o revestimientos internos y/o externos. *В соответствии с документом BGR 181 (Fußböden in Arbeitsräumen und Arbeitsbereichen mit Rutschgefahr, aktualisierte Fassung Oktober 2003) компания Florim рекомендует использовать настоящий материал для напольного покрытия полов внутренних помещений или для внутренней и/или внешней настенной облицовки.



NATURALE/SQUADRATO/R10*

MATTE/SQUARED/R10
NATUREL/EQUARRI/R10
MATT/VIERKANTIG/R10
MATE/ESCUADRADO/R10
НАТУРАЛЬНЫЙ/ОБТЕСАННЫЙ/R10



POINT/SQUADRATO/R11/CLASSE C

POINT/SQUARED/R11/CLASS C
POINT/EQUARRI/R11/CLASSE C
POINT/VIERKANTIG/R11/GRUPPE C
POINT/ESCUADRADO/R11/CLASE C
POINT/ОБТЕСАННЫЙ/R11/КЛАСС C



LEVIGATO/SQUADRATO

POLISHED/SQUARED
POLI/EQUARRI
POLIERT/VIERKANTIG
PULIDO/ESCUADRADO
ПОЛИРОВАННЫЙ/ОБТЕСАННЫЙ

WARM/4.0

WARM/5.0



N° 317/001E

Recycled Content 41%



N° 317/001E

Recycled Content 41%



COOL/1.0

V2



MODERATE



COOL/2.0*
*ROC ARGENT

V2



MODERATE



COOL/3.0

V2



MODERATE



WARM/1.0
*PEBBLE

V2



MODERATE



WARM/2.0*
*HAUTE VILLE

V2



MODERATE

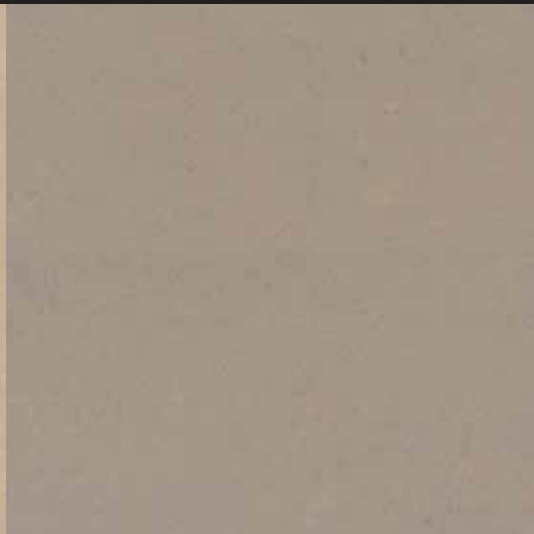

WARM/3.0

V2



MODERATE

GRADO DI VARIAZIONE CROMATICA

DEGREE OF COLOUR CHANGE
DEGRE DE VARIATION CHROMATIQUE
GRAD DER FARBABWEICHUNG
GRADO DE VARIACIÓN CROMÁTICA



COOL/4.0*
*CHARBON

V2



MODERATE

COOL/5.0

V2



MODERATE



WARM/4.0

V2



MODERATE

WARM/5.0

V2



MODERATE

GRADO DI VARIAZIONE CROMATICA

DEGREE OF COLOUR CHANGE
DEGRE DE VARIATION CHROMATIQUE
GRAD DER FARBABWEICHUNG
GRADO DE VARIACIÓN CROMÁTICA

V1

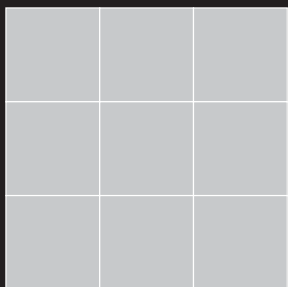

LOW

PRODOTTO MONOCROMATICO.
THE LEAST AMOUNT OF SHADE
AND TEXTURE VARIATION,
ATTAINABLE IN NATURALLY
FIRED CLAY PRODUCTS.
PRODUIT MONOCHROMATIQUE.
EINFARBIGES PRODUKT.
PRODUCTO MONOCROMÁTICO.

V2

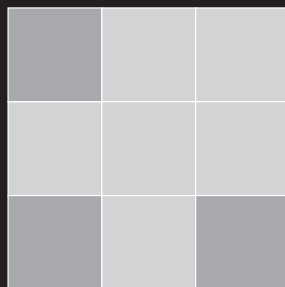

MODERATE

**PRODOTTO CON LEGGERA
VARIAZIONE CROMATICA.**
LIGHT TO MODERATE SHADE AND TEXTURE
VARIATION WITHIN EACH CARTON.
PRODUIT À LÉGERE VARIATION CHROMATIQUE.
PRODUKT MIT LEICHTER FARBNUANCE.
PRODUCTO CON UNA PEQUEÑA
VARIACIÓN CROMÁTICA.

V3

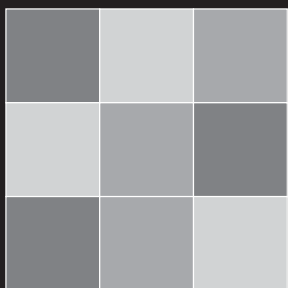

HIGH

**PRODOTTO CON MARCATA
VARIAZIONE CROMATICA.**
HIGH SHADE TEXTURE VARIATION
WITHIN EACH CARTON.
PRODUIT À VARIATION
CHROMATIQUE ACCENTUÉE.
PRODUKT MIT AUSGEPRÄGTER
FARBNUANCE.
PRODUCTO CON EVIDENTE
VARIACIÓN CROMÁTICA.

V4

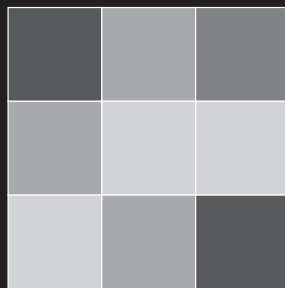

RANDOM

**PRODOTTO CON FORTE
VARIAZIONE CROMATICA.**
VERY HIGH SHADE AND TEXTURE
VARIATION WITHIN EACH CARTON.
PRODUIT À FORTE VARIATION CHROMATIQUE.
PRODUKT MIT STARKER FARBNUANCE.
PRODUCTO CON FUERTE
VARIACIÓN CROMÁTICA.

SQUADRATO

Piastrelle o lastre ceramiche portate a dimensioni predefinite, ognuna esattamente uguale all'altra (monocalibro) con sistema di mole abrasive. La precisione della lavorazione consente di posare i materiali accostati per realizzare ambienti nei quali i bordi di ogni singolo pezzo diventano invisibili nelle superfici posate.

SQUARED

Ceramic tiles or slabs made to a pre-defined size, each one exactly the same as the others (single size), using a system of abrasive grinders. The precision of the processing work means that the material can be laid without joints to create areas in which the edges of each tile become invisible in the laid surfaces.

EQUARRI

Carreaux ou dalles céramiques mises aux dimensions prédéfinies, parfaitement identiques l'une à l'autre (mono-calibre) grâce à un système de disques abrasifs. La précision du travail permet de poser les matériaux les uns à côté des autres afin de réaliser des espaces où les bords de chaque pièce deviennent invisibles sur les surfaces posées.

VIERKANTIG

Fliesen oder Keramikplatten mit festgelegten Formaten. Alle Fliesen sind aufgrund der Verwendung des Schleifscheiben-Systems hundertprozentig identisch (Monokaliber). Durch die Fertigungsgenauigkeit können die Fliesen eng verlegt werden, um Räumlichkeiten zu gestalten, in denen die Ränder jeder einzelnen Fliese in der verlegten Gesamtfläche unsichtbar werden.

ESCUADRADO

Baldosas o placas cerámicas fabricadas con dimensiones predefinidas, todas exactamente iguales (tamaño único), mediante un sistema de discos abrasivos. La precisión de la elaboración permite colocar las piezas tan juntas, que sus bordes resultan prácticamente invisibles al observar el conjunto de la superficie solada o revestida.





WARM/3.0









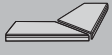

COOL/4.0

CHROMTECH/1.0/PRODUCT CODES

	60x120 23 ⁵ / ₈ "x47 ¹ / ₈ "	60x60 23 ⁵ / ₈ "x23 ⁵ / ₈ "	30x60 11 ³ / ₄ "x23 ⁵ / ₈ "	30x30 11 ³ / ₄ "x11 ³ / ₄ "	60x120 23 ⁵ / ₈ "x47 ¹ / ₈ "	60x60 23 ⁵ / ₈ "x23 ⁵ / ₈ "	30x60 11 ³ / ₄ "x23 ⁵ / ₈ "	30x30 11 ³ / ₄ "x11 ³ / ₄ "
								
	LEVIGATO/POLISHED/POLI/POLIERT/PULIDO				NATURALE/MATTE/NATUREL/ MATT/ MATE			
Spessore / Thickness Epaisseur / Dicke Espesor / Толщина	 9,5 mm 3/8"				 10 mm 3/8"			
COOL/1.0	718641	715610	715622	715634	718631	715604	715616	715628
COOL/2.0 (ROC ARGENT)	718642	715254	10334	7960	718632	715250	10325	7954
COOL/3.0	718643	715611	715623	715635	718633	715605	715617	715629
COOL/4.0 (CHARBON)	718644	715255	10341	8827	718634	715251	10332	8832
COOL/5.0	718645	715612	715624	715636	718635	715606	715618	715630
WARM/1.0 (PEBBLE)	718646	715253	10336	7959	718636	715249	10327	7953
WARM/2.0 (HAUTE VILLE)	718647	715252	10335	7958	718637	715248	10326	7952
WARM/3.0	718648	715607	715619	715631	718638	715601	715613	715625
WARM/4.0	718649	715608	715620	715632	718639	715602	715614	715626
WARM/5.0	718650	715609	715621	715633	718640	715603	715615	715627

CHROMTECH/1.0/SPECIAL PIECES CODES

	33x60 13"x23 ⁵ / ₈ "	33x60 13"x23 ⁵ / ₈ "	4,6x60 1 ³ / ₄ "x23 ⁵ / ₈ "	4,6x60 1 ³ / ₄ "x23 ⁵ / ₈ "	15x30x8 5 ⁷ / ₈ "x11 ³ / ₄ "x3 ¹ / ₈ "	15x30x8 5 ⁷ / ₈ "x11 ³ / ₄ "x3 ¹ / ₈ "	15x30x8 5 ⁷ / ₈ "x11 ³ / ₄ "x3 ¹ / ₈ "	1,2x30 1/2"x11 ³ / ₄ "	1,2x30,8 1/2"x12 ¹ / ₈ "
									
	NATURALE MATTE/NATUREL MATT/ MATE		LEVIGATO POLISHED/POLI POLIERT/PULIDO	NATURALE MATTE/NATUREL MATT/ MATE					
	GRADINO	ANGOLO ESTERNO	BATTISCOPIA	BATTISCOPIA	COVE BASE	ANGOLO INTERNO COVE BASE	ANGOLO ESTERNO COVE BASE	QUARTER ROUND	ANGOLO QUARTER ROUND
COOL/1.0	716306	716316	745497	745487	716346	716356	716366	716376	716386
COOL/2.0 (ROC ARGENT)	716307	716317	745498	745488	716347	716357	716367	716377	716387
COOL/3.0	716308	716318	745499	745489	716348	716358	716368	716378	716388
COOL/4.0 (CHARBON)	716309	716319	745500	745490	716349	716359	716369	716379	716389
COOL/5.0	716310	716320	745501	745491	716350	716360	716370	716380	716390
WARM/1.0 (PEBBLE)	716301	716311	745502	745492	716341	716351	716361	716371	716381
WARM/2.0 (HAUTE VILLE)	716302	716312	745503	745493	716342	716352	716362	716372	716382
WARM/3.0	716303	716313	745504	745494	716343	716353	716363	716373	716383
WARM/4.0	716304	716314	745505	745495	716344	716354	716364	716374	716384
WARM/5.0	716305	716315	745506	745496	716345	716355	716365	716375	716385

CHROMTECH/1.0/SPECIALPIECES



	30x60 11 ³ / ₄ "x23 ⁵ / ₈ "	30x30 11 ³ / ₄ "x11 ³ / ₄ "
	POINT	■
	 10 mm 3/8"	TESSERE MOSAICO 5 cm - 2"
	715880	716287
	715881	716288
	715882	716289
	715883	716290
	715884	716291
	715875	716282
	715876	716283
	715877	716284
	715878	716285
	715879	716286

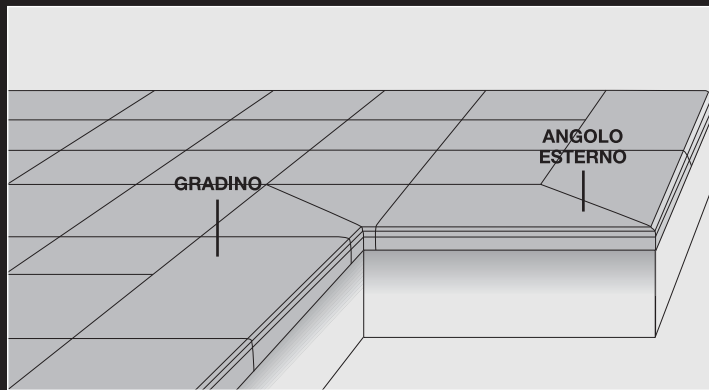
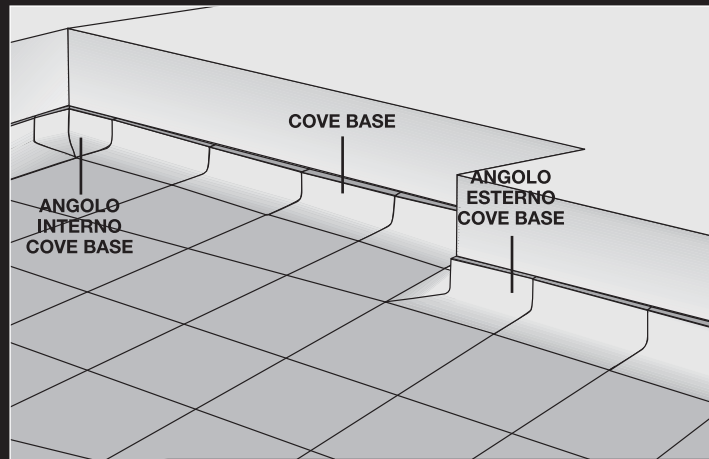

CHROMTECH/1.0/SPECIALPIECES

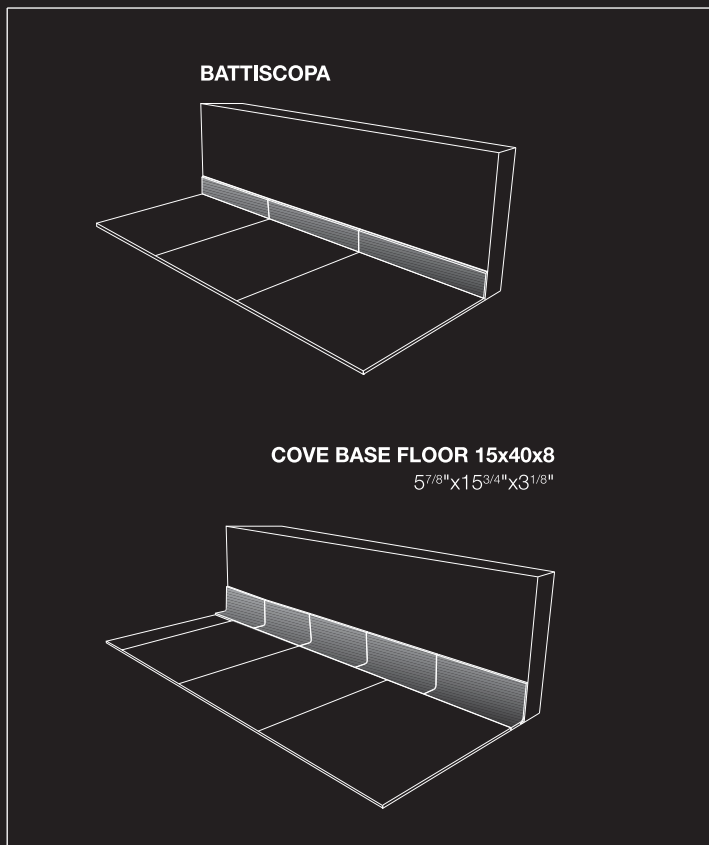

classi di utilizzo

Application Classes - Groupes d'utilisation - Anwendungsklassen - Clases de uso - Классы применения

Classificazione dei prodotti Florim in base alle destinazioni d'uso

Per facilitare il lavoro di progettisti e rivenditori, e le scelte del consumatore finale, Florim ha definito una classificazione delle proprie superfici in base alle diverse destinazioni d'uso.

Tale classificazione è stata elaborata tenendo conto di diversi fattori:

1. analisi del tipo e grado di sollecitazioni a cui le superfici sono sottoposte nei diversi ambienti di utilizzo
2. individuazione delle prove tecniche in grado di verificare le performance necessarie (oltre alle prove tecniche previste dalle norme in vigore sono stati inseriti ulteriori test definiti dai laboratori Florim)

Per effettuare una corretta scelta dei prodotti, si consiglia sempre di verificare la classe di appartenenza in relazione alla destinazione d'uso.

Questa classificazione ha un valore indicativo e generale: è un servizio Florim per consentire ai propri interlocutori una valutazione e selezione dei prodotti più consapevole e rapida. La scelta corretta e definitiva deve essere sempre attentamente valutata in ogni caso specifico dal professionista o dal progettista in base al contesto e alle reali condizioni d'uso del materiale (tipologia e conformazione dell'ambiente, tipo di sporco, intervalli di manutenzione, tipo di posa in opera ecc.).

E' comunque sempre indispensabile verificare la corrispondenza del materiale ai requisiti tecnici richiesti da norme o legislazioni locali.

Nota: l'ufficio tecnico e la Divisione Progetti Florim sono a disposizione di rivenditori e progettisti per fornire assistenza nella scelta del materiale più idoneo alle diverse tipologie di ambiente, soprattutto in caso di applicazioni in contesti particolari (ad es. laboratori chimici, ecc.).

Classification of Florim products in relation to their intended use

In order to simplify the task of architects and dealers, and aid final consumers when choosing materials, Florim has classified its coverings on the basis of their different intended uses.

This classification considers several different factors:

1. analysis of the types of stresses to which the coverings are subjected in their various contexts of use
2. specification of the technical tests needed to verify the necessary performance ratings (further tests set by the Florim laboratories have been added as well as the technical tests required by the relevant standards).

To ensure the suitability of the chosen product, the covering's class should always be checked against its intended use.

This classification is general and purely guideline: it is a Florim service designed to enable its partners and customers to assess and choose products more quickly and effectively. The final choice must always be carefully considered by the architect or professional in every specific case, in relation to the context and real conditions of use of the material (building type and conformation, type of dirt, care intervals, installation method, etc.).

In all cases, it is essential to check that the material meets the technical requirements of local standards or legislation.

N.B.: the Florim technical department and Projects Division are at the service of dealers and architects to provide assistance in choosing the material best suited to various contexts, especially in the event of applications in unusually demanding settings (e.g. chemical laboratories, etc.).

Classement des produits Florim en fonction des domaines d'application

Pour faciliter le travail des architectes et des revendeurs et aider le consommateur final à faire son choix, Florim a classé ses surfaces en fonction des différents domaines d'application.

Ce classement a été rédigé en tenant compte de plusieurs facteurs :

1. analyse du type et du niveau de sollicitations auxquelles les surfaces sont exposées dans les différents lieux de pose
2. détermination des essais techniques capables de vérifier les performances nécessaires (outre les essais techniques prévus par les normes en vigueur, les laboratoires Florim ont introduit des épreuves supplémentaires)

Pour ne pas faire de mauvais choix, nous recommandons toujours de s'assurer que le groupe d'appartenance convient au domaine d'application.

Ce classement est donné à titre indicatif et général : avec ce service, Florim permet à ses propres interlocuteurs d'évaluer et de sélectionner les produits vite et en toute connaissance de cause. En cas de projets spécifiques, l'opérateur professionnel ou l'architecte doit toujours examiner avec soin le choix définitif par rapport au domaine et aux conditions réelles d'application du matériau (catégorie et structure du lieu de pose, type de saleté, fréquence d'entretien, type d'application, etc.).

Toutefois, il est toujours indispensable de contrôler que le matériau satisfait aux exigences techniques imposées par les normes ou les règlements locaux.

Remarque : le bureau technique et la Division Projets Florim sont à la disposition des revendeurs et des architectes afin de les aider à choisir le matériau qui convient le mieux aux différents domaines d'application, notamment en cas de poses dans des locaux spécifiques (par ex. laboratoires chimiques, etc.).

Klassifizierung Florim Produkte nach Bestimmungszweck

Um die Arbeit von Planern und Händlern sowie die Wahl des Kunden zu erleichtern, führte Florim eine Klassifizierung der Oberflächen nach den verschiedenen Bestimmungszwecken ein.

Bei der Ausarbeitung dieser Klassifizierung wurden verschiedene Faktoren berücksichtigt:

1. Untersuchung der Art und des Grades der Belastungen, denen die Oberflächen in den verschiedenen Anwendungsbereichen ausgesetzt sind.
2. Feststellung der technischen Prüfungen zum Testen der erforderlichen Eigenschaften (nicht nur die durch die geltenden Bestimmungen vorgeschriebenen, sondern auch Tests der Florim Laboratorien)

Für die richtige Wahl sollte man stets vom Bestimmungszweck ausgehen und dann die Zugehörigkeitsklasse ermitteln.

Diese Klassifizierung hat einen allgemeinen und unverbindlichen Charakter. Es ist ein Service, den die Firma Florim ihren Geschäftspartnern im Hinblick auf eine sichere und rasche Beurteilung und Auswahl bietet. Die richtige und definitive Wahl erfordert stets eine sorgfältige Beurteilung durch den Fachmann oder Planer, der von Fall zu Fall die Begleitumstände und effektiven Anwendungsbedingungen prüft (Art und Beschaffenheit des Verlegeorts, Art des Schmutzes, Pflegeabstände, Art der Verlegung, usw.).

In jedem Fall muss geprüft werden, ob das Material die technischen Merkmale aufweist, die durch örtliche Bestimmungen oder Gesetzgebungen verlangt werden.

Hinweis: Das technische Büro und die Planungsabteilung von Florim stehen Händlern und Planern zur Verfügung, um sie bei der Wahl des richtigen Materials für die anwendungsspezifischen Anforderungen zu unterstützen, vor allem unter besonderen Gegebenheiten (z. B. Chemielaboratorien, usw.).

Clasificación de los productos Florim según su destinación de uso

Para facilitar el trabajo de proyectistas y revendedores y la decisión del consumidor final, Florim ha establecido una clasificación de sus superficies sobre la base de los varios usos a que puedan ir destinadas.

Dicha clasificación se ha elaborado teniendo en cuenta varios factores:

1. análisis del tipo y grado de esfuerzos a que las superficies van a estar sometidas en los diferentes lugares de uso;
2. determinación de los ensayos técnicos que hay que efectuar para comprobar el buen rendimiento necesario (además de las pruebas técnicas previstas por las normas vigentes se han introducido otros tests establecidos por los laboratorios de Florim).

Para realizar una correcta elección de los productos se aconseja verificar siempre la clase de pertenencia con respecto a la aplicación que se vaya a dar al artículo.

Esta clasificación tiene un valor orientativo y general: se trata de un servicio que Florim ofrece para que sus interlocutores puedan valorar y seleccionar los productos de manera más rápida y con mayor conocimiento de causa.

El profesional o el proyectista realizará siempre la elección correcta y definitiva con detenimiento y tomando en consideración las especificidades de cada caso sobre la base del contexto y las condiciones reales de uso del material (tipo y conformación del lugar, clase de suciedad, frecuencia de las intervenciones de mantenimiento, tipo de colocación, etc.).

En cualquier caso resulta indispensable comprobar que el material responde a las exigencias técnicas requeridas por las normas o las legislación locales.

Nota: la oficina técnica y la División de Proyectos de Florim están a disposición de revendedores y proyectistas para proporcionar asistencia en la elección del material más adecuado a los distintos tipos de lugar, sobre todo en caso de aplicaciones en contextos especiales (como, por ejemplo, laboratorios químicos, etc.).

Классификация продукции Florim по эксплуатационному назначению

Для облегчения работы дизайнеров и продавцов, а также выбора конечного потребителя, Florim классифицировала свою плитку по назначению.

Эта классификация была разработана с учетом разных факторов:







1. анализ типа и степени воздействия, которому плитка подвергается в разных помещениях эксплуатации
2. определение технических испытаний, способных проверить необходимые характеристики (помимо предусмотренных действующими законами технических испытаний были добавлены дополнительные испытания, указанные лабораториями Florim)

Для правильного выбора плитки рекомендуем всегда проверять ее класс назначения.

Эта классификация носит общий, показательный характер, - это услуга, предложенная Florim своим заказчикам для того, чтобы они смогли более уверенно и быстро оценить и выбрать продукцию. Правильность окончательного выбора должен в каждом конкретном случае оценить профессиональный работник или дизайнер в зависимости от окружения и от конкретных условий эксплуатации материала (тип и форма помещения, тип загрязнения, периодичность обслуживания, тип укладки и т.д.).

Тем не менее, следует всегда проверять соответствие материала техническим условиям, требуемым местными нормами или законами.

Примечание: технический отдел и проектное отделение Divisione Progetti Florim находятся в распоряжении продавцов и дизайнеров, и готовы помочь в выборе самого подходящего материала для разных типов помещения, особенно в случае специального применения (например, химические лаборатории, и т.д.).

	Tipologia di ambiente	Type of environment	Typologie d'environnement	Art Raum	Tipo de ambiente	Тип окружающей среды
	Pavimentazioni industriali (magazzini, depositi, fabbriche) e arredo urbano	Industrial floors (warehouses, deposits, factories) and site amenities.	Carrelages industriels (entrepôts, dépôts, usines) et aménagement urbain.	Industrielle Bodenbeläge (Lagerhallen, Lagerplätze, Fabriken) und städtische Einrichtungen.	Pavimentos industriales (almacenes, depósitos, fábricas) y mobiliario urbano.	Промышленные полы (склады, хранилища, цеха) и городское благоустройство.
	Ambienti pubblici interni ad alto traffico come: stazioni ferroviarie, metropolitane, aeroporti, centri commerciali, musei, chiese, ospedali, banche, uffici pubblici, scuole, centri sportivi, hall di alberghi. Ambienti pubblici esterni ad alto traffico sottoposti a forti carichi statici/dinamici.	Indoor public environments subject to heavy pedestrian traffic such as: Railway stations, Underground stations, Airports, Shopping malls, Museums, Churches, Hospitals, Banks, Public Offices, Schools, Sports centres, Hotel lobbies. Outdoor public environments subject to heavy pedestrian traffic and to static/dynamic loads.	Zones intérieures de bâtiments publics avec trafic important tels que : Gares, Métros, Aéroports, Centres commerciaux, Musées, Églises, Hôpitaux, Banques, Bureaux ouverts au public, Ecoles, Centres de sport Halls d'hôtel. Zones extérieures de bâtiments publics avec trafic important et soumis à de fortes charges statiques/dynamiques.	Öffentliche Innenräume mit hoher Begehungsfrequenz, wie: Bahnhöfe, Untergrundbahnen, Flughäfen, Einkaufszentren, Museen, Kirchen, Krankenhäuser, Banken, Ämter, Schulen, Sportzentren, Empfangshallen in Hotels. Öffentliche Außenräume mit hoher Begehungsfrequenz und dichter statischer/dynamischer Last.	Ambientes públicos interiores con tránsito intenso, como: Estaciones de Ferrocarril, Subterráneos, Aeropuertos, Centros comerciales, Museos, Iglesias, Hospitales, Bancos, Oficinas públicas, Escuelas, Centros deportivos, Vestibulos de hoteles. Ambientes públicos exteriores con tránsito intenso y sometidos a fuertes cargas estáticas y dinámicas.	Интерьеры общественных объектов с высокой интенсивностью хождения, такие как: Железнодорожные вокзалы Метрополитен, Аэропорты Торговые комплексы Музеи, Церкви, Больницы Банки, Общественные офисы Школы, Спортивные центры Холлы гостиниц. Наружные общественные объекты с высокой интенсивностью движения, подверженные высоким статическим/динамическим нагрузкам.
	Ambienti pubblici interni a medio traffico come: ristoranti, bar, uffici, negozi, laboratori, biblioteche, sale convegni, corridoi di albergo. Ambienti pubblici esterni a medio traffico come: scale esterne, terrazze, giardini privati. Verificare le caratteristiche di scivolosità in funzione dell'ambiente di destinazione, in conformità a norme o leggi vigenti.	Indoor public environments subject to medium pedestrian traffic such as: Restaurants, Cafés, Offices, Shops, Libraries, Convention rooms, Hotel corridors. Outdoor public environments subject to medium pedestrian traffic such as: Outdoor stairs, Terraces, Private gardens. Always check the slipperiness characteristics according to the intended environment, in conformity with applicable regulations or laws.	Zones intérieures de bâtiments publics avec trafic modéré tels que : Restaurants, Bars, Bureaux, Magasins, Bibliothèques, Salles de congrès, Couloirs d'hôtel. Zones extérieures de bâtiments publics avec trafic modéré tels que : Escalier extérieurs, Terrasses, Jardins privés. Toujours vérifier les caractéristiques de risque de glissement en fonction du local de destination conformément à la réglementation ou aux lois en vigueur.	Öffentliche Innenräume mit mittlerer Begehungsfrequenz, wie: Restaurants, Bars, Büros, Geschäfte Bibliotheken, Kongresssäle, Hotelgänge Öffentliche Außenräume mit mittlerer Begehungsfrequenz wie: Außentreppe, Terrassen, Privatgärten. Die Eigenschaften der Rutschsicherheit sind immer gemäß geltenden Richtlinien oder Gesetzen mit Bezug auf den Bestimmungsort zu überprüfen.	Ambientes públicos interiores con tránsito medio, como: Restaurantes, Bares, Oficinas, Tiendas, Bibliotecas, Salas de congresos, Corredores de hotel. Ambientes públicos exteriores con tránsito medio, como: Escaleras exteriores, Terrazas, Jardines privados. Verifique siempre las características de resbalamiento en función del ambiente de uso, en conformidad con las normas y leyes vigentes	Интерьеры общественных заведений со средней интенсивностью хождения, такие как: Рестораны, Бары, Офисы, Магазины, Библиотеки, Конгресс-залы Коридоры гостиниц. Наружные общественные заведения со средней интенсивностью хождения, такие как: Наружные лестницы, Террасы, Частные парки. Всегда проверяйте характеристики скользкости, учитывая тип помещения, в соответствии с действующими нормами и законами.
	Centri benessere Piscine SPA Palestre Spogliatoi Verificare le caratteristiche di scivolosità in funzione dell'ambiente di destinazione, in conformità a norme o leggi vigenti.	Wellness centres Swimming-pools Spas Gyms Dressing rooms Always check the slipperiness characteristics according to the intended environment, in conformity with applicable regulations or laws.	Centres de remise en forme Piscines Spas Salles de sport Vestiaires Toujours vérifier les caractéristiques de risque de glissement en fonction du local de destination conformément à la réglementation ou aux lois en vigueur.	Wellness-Centres Schwimmbäder Spas Turnhallen/Fitnesscenter Umkleieräume Die Eigenschaften der Rutschsicherheit sind immer gemäß geltenden Richtlinien oder Gesetzen mit Bezug auf den Bestimmungsort zu überprüfen.	Centros de bienestar Piscinas Spa Gimnasios Vestuarios Verifique siempre las características de resbalamiento en función del ambiente de uso, en conformidad con las normas y leyes vigentes	Оздоровительные центры Бассейны Термальные центры Бассейны Раздевалки Всегда проверяйте характеристики скользкости, учитывая тип помещения, в соответствии с действующими нормами и законами.
	Residenziale zona giorno Residenziale zona notte Camere di albergo Bagni	Residential day area Residential night area Hotel rooms Bathrooms	Résidentiel zone jour Résidentiel zone nuit Chambres d'hôtel Salles de bains	Wohngebäude Bereich Tag Wohngebäude Bereich Nacht Hotelzimmer Badezimmer	Residencial zona día Residencial zona noche Habitaciones de hotel Baños	Гостиные Спальни Гостиничные номера Ванные
	Rivestimenti interni Rivestimenti esterni	Indoor wall tiles Outdoor wall tiles	Revêtements muraux intérieurs Revêtements muraux extérieurs	Wandverkleidungen Innenbereich Wandverkleidungen Außenbereich	Revestimientos interiores Revestimientos exteriores	Внутренняя облицовка Наружная облицовка



放射性水平 A

Certificazione obbligatoria per l'esportazione in Cina
 Certification mandatory for export to China
 Certification obligatoire pour l'exportation en Chine
 Für den Export nach China obligatorische Zertifizierung
 Certificación obligatoria para la exportación a China
 Обязательная сертификация для экспорта в Китай

Product Certification
BUREAU VERITAS
 Certification

N° 317/001E



Sistema di gestione della Qualità:
 Certificato n°. 50 100 1271

Sistema di gestione dell'Ambiente:
 Certificato n°. 50 100 100 74

Sistema di gestione della Salute e Sicurezza dei lavoratori:
 Certificato n°. 11 100 802

Sistema di gestione dell'Energia:
 Certificato n°. 12 340 47521



FLORIM Ceramiche S.p.A
 Via Canaletto, 24 - 41042 Fiorano Modenese (MO) - Italia

05

FLORIM 001

EN 14411:2012

Dry-pressed ceramic tiles, with water absorption $E_b \leq 0,5 \%$, for internal and external walls and floorings

Per informazioni relative ai dati tecnici su marcatura CE vedere il sito www.floorgres.it
 Please refer to our web site www.floorgres.it for technical information related to CE labeling
 Pour tout renseignement sur l'avis technique de la marque CE veuillez consulter le site www.floorgres.it
 Informationen bezüglich technischer Daten zur Beschriftung CE entnehmen Sie unserer Website www.floorgres.it
 Para informaciones relativas a las especificaciones técnicas sobre la marca CE, chequear el sitio www.floorgres.it
 ИНФОРМАЦИЯ ПО ТЪХ, ЦКННЫМ, ОТНОСЯЩИМСЯ К МКРКИРОНКЪ "СЕ" ПРИНЪЛЪТЪНК НК СКЪТЪ www.floorgres.it



CHROMTECH/1.0



MADE IN FLORIM

FLORIM CERAMICHE S.p.A. con socio unico

sede legale: via canaletto 24 / 41042 fiorano modenese mo italy / t. +39 0536 840111 / f. +39 0536 844750 / w. floorgres.it