

In&Out





# IN & OUT

---

Vivere la propria casa al meglio  
e godere pienamente di ogni suo spazio.  
Valorizzare gli ambienti della propria vita  
e personalizzarne lo stile.  
Combinare perfettamente eleganza e sicurezza.  
Vallelunga.  
In&Out.

Live your own home at its best and  
fully enjoy each space of it.  
Appreciate the environments of life  
and personalize its style.  
Perfectly combine elegance and safety.  
Vallelunga.  
In&Out.

Позволить себе наиболее полно наслаждаться  
каждым уголком своего дома.  
Придать больше ценности окружающему Вас интерьеру и создать  
свой собственный неповторимый стиль.  
Идеальное сочетание элегантности с безопасностью  
Vallelunga.  
In&Out.



# IN

Moderno e armonioso per esaltare i tuoi interni...

Modern and harmonious to exalt your interior...

Современный и гармоничный подчеркнет красоту Вашего интерьера...



# OUT

...efficace e resistente per adattarsi al meglio ai tuoi esterni.

...efficacious and resistant to best fit your external.

...удобный и прочный лучшим образом подойдет для внешней отделки.

---

La casa è lo specchio di chi la vive.  
Il luogo ideale dove coltivare le  
proprie idee e i propri desideri.  
Un nido nel quale sentirsi  
accolti e protetti.

The house is a reflection of those who live inside.  
The ideal place to grow own  
ideas and desires.  
A nest in which to feel welcomed  
and protected.

Дом как зеркало отражает тех, кто в нем живет.  
Идеальное место для создания собственных  
идей и собственных желаний.  
Гнездышко, где можно почувствовать себя  
обласканным и защищенным.

**IN** &  
**OUT**





**IN Bianco**

29,7x59,5

---

# IN Bianco

59,5x59,5



---

I formati ideali per personalizzare gli spazi secondo i gusti e le necessità.  
Adattare la casa alle proprie esigenze, rendere unico ogni luogo.

The ideal sizes to personalize the spaces according to the tastes and needs.  
Adapt the home to own needs, make unique every place.

Идеальный формат для персонализации пространства согласно вкусу и потребностям.  
Приспособить дом под свои запросы, сделать уникальным каждый его уголок.

**IN**  
**OUT** &

---

rettificato



29,7x59,5

59,5x59,5

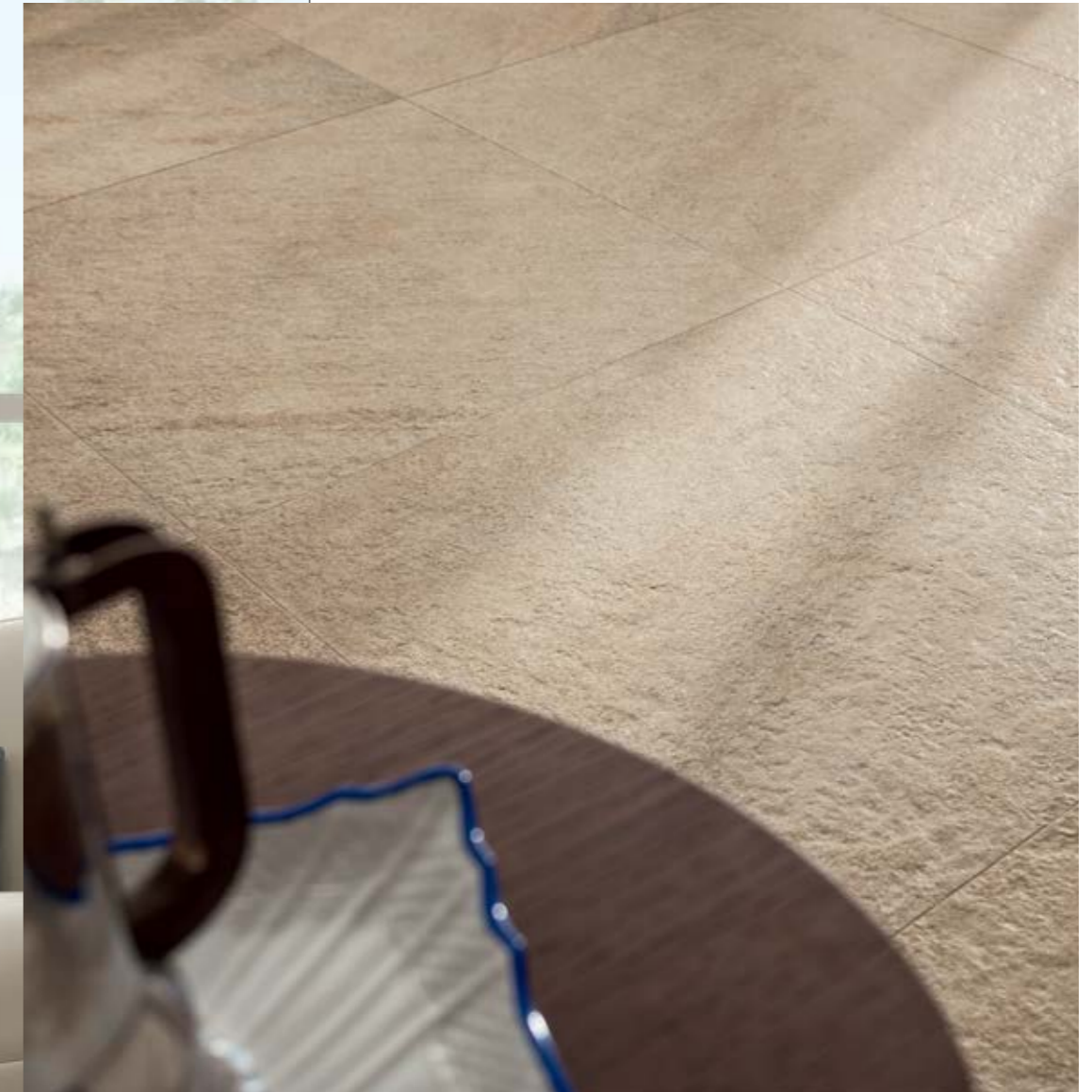

**IN Beige**  
59,5x59,5





---

## IN Beige

29,7x59,5

**IN&OUT Grigio**

59,5x59,5 IN - 30x60 OUT



---

La soluzione ideale per godere della libertà degli spazi all'aperto. Vivere le sensazioni che l'ambiente ci regala in un'atmosfera accogliente e sicura.

The perfect solution to enjoy freedom of open spaces. Experience the feelings that the environment gives us in a safety and hospitable atmosphere.

Идеальное решение, позволяющее наслаждаться свободой на открытом воздухе. Проживать ощущения теплоты и безопасности, которые дарит нам окружающая среда.

**IN** &  
**OUT**

---

# R12 antislip (A+B+C)

Il coefficiente A+B+C significa che la superficie gode di massime proprietà antiscivolo e garantisce un livello di sicurezza ottimale; è il grado più elevato nella scala ufficiale che identifica la resistenza allo scivolamento di una superficie.

The coefficient A + B + C means that the surface has the maximum slip resistance and guarantees an optimum level of safety; it is the highest level in the official graduation that identifies the slip resistance of a surface.

Коэффициент A+B+C означает, что поверхность имеет максимальные противоскользящие свойства и обеспечивает оптимальный уровень безопасности, это самый высокий показатель по официальной шкале, определяющей сопротивление скольжению поверхности.

30x60

20x40

20x20



---

## OUT Bianco

30x60  
mosaico 30x30





---

## OUT Bianco

30x60 - 20x40  
mosaico 30x30  
elemento ad "L" continuo

---



## OUT Grigio

30x60 - 20x20  
coda di pavone 58x36,2



---

## OUT Beige

30x60 - 20x40 - 20x20



---

## OUT Beige

30x60





# IN Bianco



G2102A IN BIANCO RETT. 29,7x59,5 - 11,7"x23,4" 43



G13503 BIANCO MURETTO 29,7x59,5 - 11,7"x23,4" 29



G1129A IN BIANCO RETT. 59,5x59,5 - 23,4"x23,4" 61

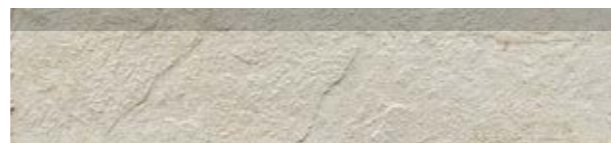

G21051 BIANCO BATTISCOPIA 9,5x40 - 3,7"x15,8" 13

# OUT Bianco



G2100A IN&OUT BIANCO 20x20 - 7,9"x7,9" R12 40



G2101A IN&OUT BIANCO 20x40 - 7,9"x15,8" R12 40



G2103A IN&OUT BIANCO 30x60 - 11,8"x23,6" R12 41



G21551 BIANCO CODA DI PAVONE 58x36,2 22,8"x14,2" 37



G21041 BIANCO MOSAICO TESSERE 5x5 - 2"x2" 30x30 - 11,8"x11,8" 15

# IN Beige



G2108A IN BEIGE RETT.  
29,7x59,5 - 11,7"x23,4" 43



G13504 BEIGE MURETTO  
29,7x59,5 - 11,7"x23,4" 29



G1130A IN BEIGE RETT.  
59,5x59,5 - 23,4"x23,4" 61



G21301 BEIGE BATTISCOPA  
9,5x40 - 3,7"x15,8" 13

# OUT Beige



G2106A IN&OUT BEIGE  
20x20 - 7,9"x7,9" R12 40



G2107A IN&OUT BEIGE  
20x40 - 7,9"x15,8" R12 40



G2109A IN&OUT BEIGE  
30x60 - 11,8"x23,6" R12 41



G21561 BEIGE CODA DI PAVONE 58x36,2 22,8"x14,2" 37



G21201 BEIGE MOSAICO  
TESSERE 5x5 - 2"x2"  
30x30 - 11,8"x11,8" 15

# IN Grigio



G2151A IN GRIGIO RETT.  
29,7x59,5 - 11,7"x23,4" 43



G13505 GRIGIO MURETTO  
29,7x59,5 - 11,7"x23,4" 29



G1131A IN GRIGIO RETT.  
59,5x59,5 - 23,4"x23,4" 61



G21541 GRIGIO BATTISCOPIA  
9,5x40 - 3,7"x15,8" 13

# OUT Grigio



G2140A IN&OUT GRIGIO  
20x20 - 7,9"x7,9" R12 40



G2150A IN&OUT GRIGIO  
20x40 - 7,9"x15,8" R12 40



G2152A IN&OUT GRIGIO  
30x60 - 11,8"x23,6" R12 41



G21571 GRIGIO CODA DI PAVONE 58x36,2 22,8"x14,2" 37



G21531 GRIGIO MOSAICO  
TESSERE 5x5 - 2"x2"  
30x30 - 11,8"x11,8" 15

# Pezzi Speciali

Special Pieces - Специальные элементы

OUT

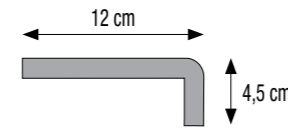
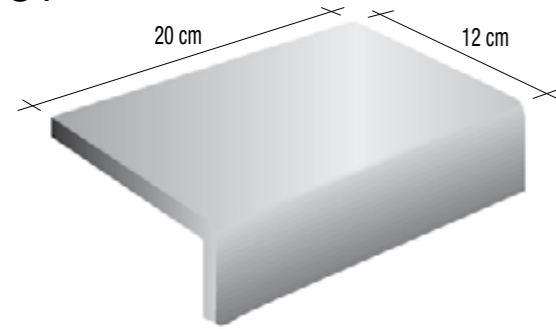

- G21581 ELEMENTO AD "L" CONTINUO BIANCO IN&OUT 20x12x4,5 7,9"x4,7"x1,8" 16
- G21591 ELEMENTO AD "L" CONTINUO BEIGE IN&OUT 20x12x4,5 7,9"x4,7"x1,8" 16
- G21601 ELEMENTO AD "L" CONTINUO GRIGIO IN&OUT 20x12x4,5 7,9"x4,7"x1,8" 16

GRES PORCELLANATO  
IMPASTO COLORATO

DIGITAL  
TECHNOLOGY

## OUT Bianco

30x60 - 20x40  
elemento ad "L" continuo



# Soluzioni di Posa

Laying Solution - Предложения по укладке

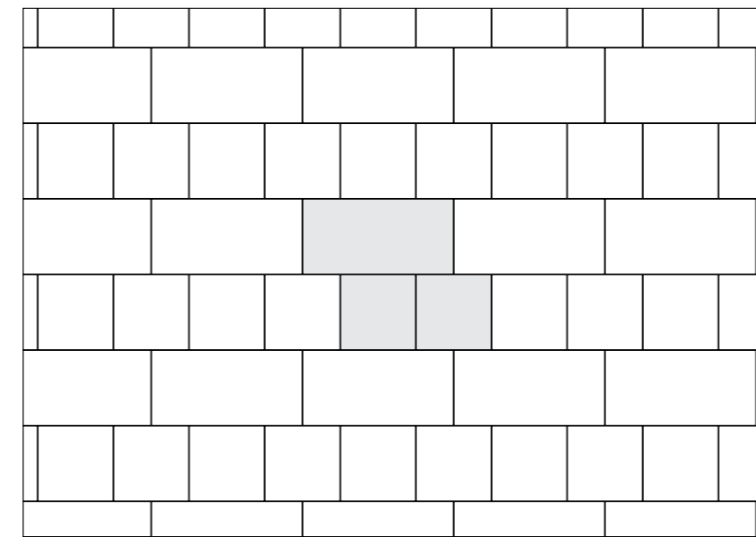

20x40 7,9"x15,8" - 50%  
20x20 7,9"x7,9" - 50%

2.01

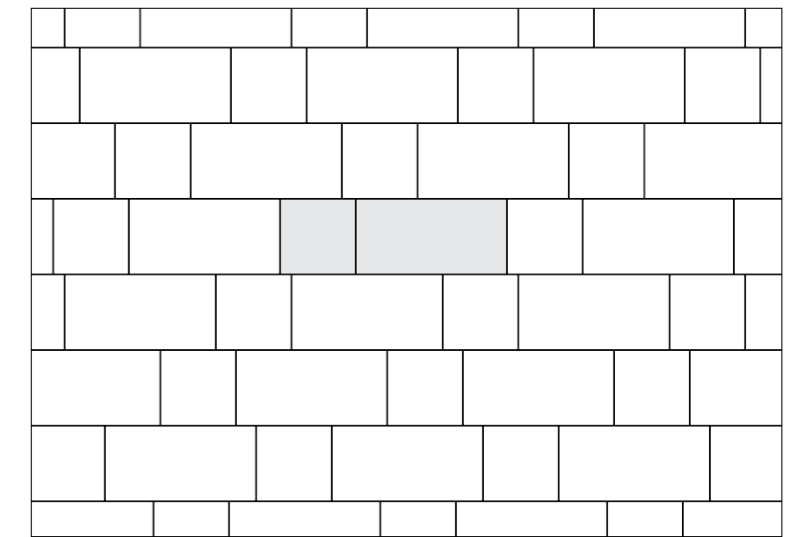

20x40 7,9"x15,8" - 66,67%  
20x20 7,9"x7,9" - 33,33%

2.02

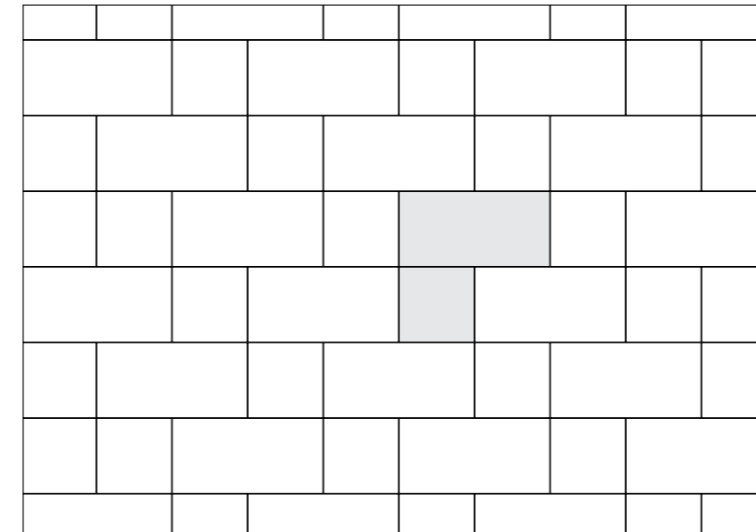

20x40 7,9"x15,8" - 66,67%  
20x20 7,9"x7,9" - 33,33%

2.03

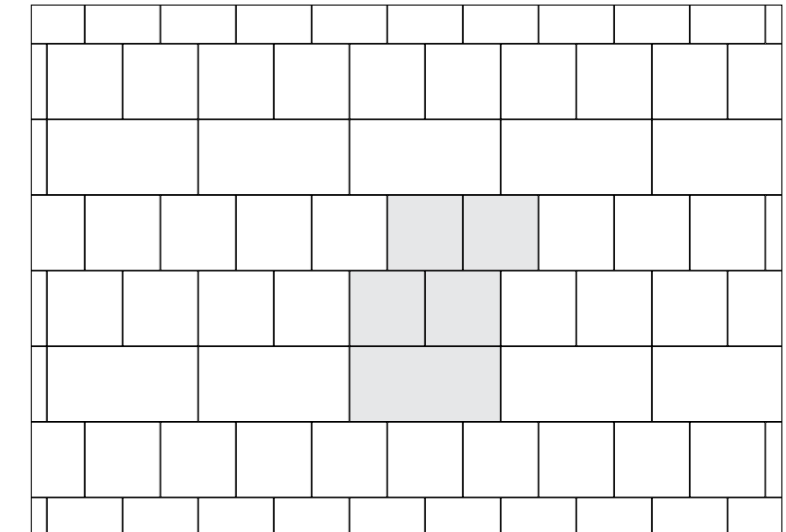

20x40 7,9"x15,8" - 33,33%  
20x20 7,9"x7,9" - 66,67%

2.04

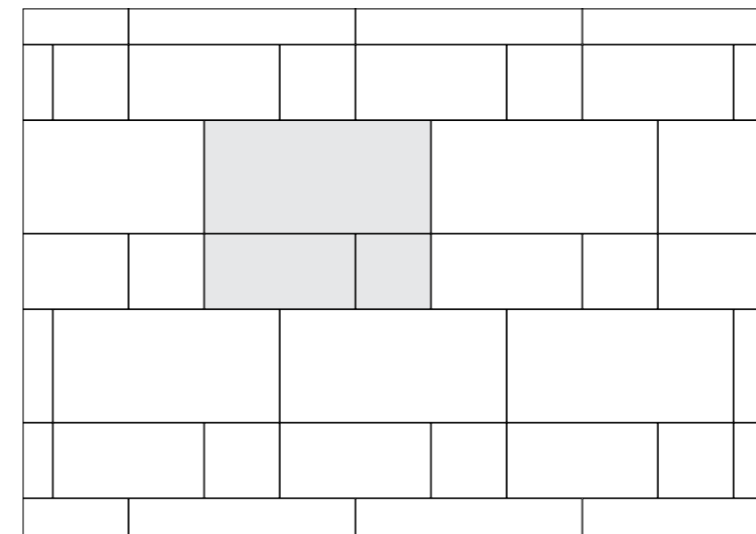

30x60 11,8"x23,6" - 60%  
20x40 7,9"x15,8" - 26,67%  
20x20 7,9"x7,9" - 13,33%

3.01

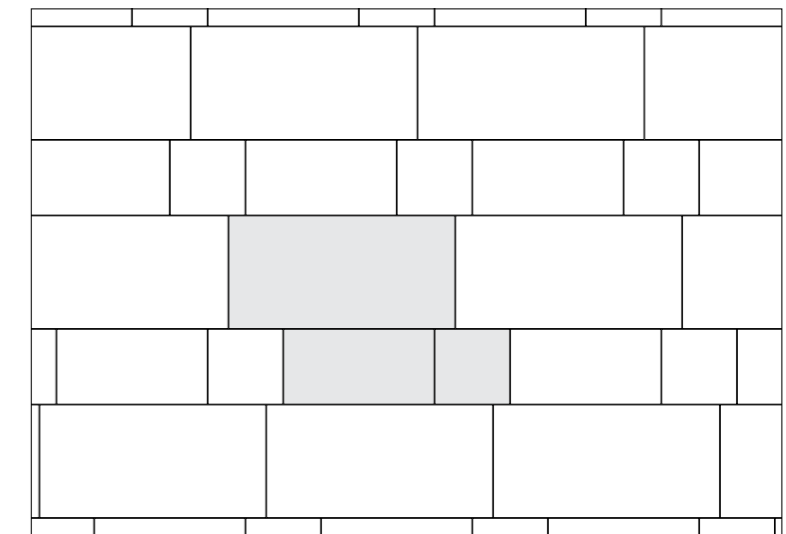

30x60 11,8"x23,6" - 60%  
20x40 7,9"x15,8" - 26,67%  
20x20 7,9"x7,9" - 13,33%

3.02

# Certificazioni

Certifications - Сертификация

**CENTRO CERAMICO**  
CENTRO DI RICERCA E SPERIMENTAZIONE PER L'INDUSTRIA CERAMICA

SEDE  
Via Martelli, 26 - 40138 Bologna  
Tel. 051 534015 - Fax 051 530085

**CERTI.CER.**  
LABORATORIO DI ZONA  
Via Valle d'Aosta, 1 - 41049 Sassuolo  
Tel. 0536 802154  
Part. IVA 0094778-0375

**TEST LABORATORY**  
Bologna, 12/02/13  
**Test report Nr° 2430/13**  
concerning ceramic tiles

Requested by: CERAMICA VALLELUNGA S.r.L. - S.S. Cassia Km 36,300  
Loc. Settevene 01036 NEPI (VT)

On (date): 06/02/13

For the sample marked: Glazed ceramic tiles of different sizes marked "Serie IN&OUT".

**ASTM C 1028-07 - Determination of static coefficient of friction**

This test method covers the measurement of static slip resistance of ceramic tile or other like surfaces under both wet and dry conditions while utilizing Neolite heel assemblies.

**PROCEDURE:**

Slider material:	Neolite
Load applied to slider (Kg):	22,7

**Results**

Test condition of the surface	Average coefficient of friction: (μ)
Dry - as received	0,84
Dry - after cleaning	0,85
Wet (saturated with distilled water) - as received	0,73
Wet (saturated with distilled water) - after cleaning	0,74

The results reported relate only to the samples tested. No responsibility is taken for the accuracy of the reporting unless it is done under our own supervision. The reproduction of this test report is only authorized in the form of a complete photographic copy. Our written approval is necessary for any partial reproduction. This test report consists of 1 pages, this cover included.

**CERLABS EUROPEAN NETWORK OF NATIONAL CERAMIC LABORATORIES - ITALIAN MEMBER**

**CENTRO CERAMICO**  
CENTRO DI RICERCA E SPERIMENTAZIONE PER L'INDUSTRIA CERAMICA

SEDE  
Via Martelli, 26 - 40138 Bologna  
Tel. 051 534015 - Fax 051 530085

**CERTI.CER.**  
LABORATORIO DI ZONA  
Via Valle d'Aosta, 1 - 41049 Sassuolo  
Tel. 0536 802154  
Part. IVA 0094778-0375

**SEZIONE CERAMICI INDUSTRIALI**  
Bologna, 12/02/13  
**Rapporto di prova N° 2434/13**  
su piastrelle di ceramica secondo EN 14411 (ISO 13006)

Richiesto da: CERAMICA VALLELUNGA S.r.L. - S.S. Cassia Km 36,300  
Loc. Settevene 01036 NEPI (VT)

In data: 06/02/13

Per il prodotto: Piastrelle di ceramica smaltate di vari formati contrassegnate "Serie IN&OUT".

**DIN 51130 (06/2004) - Determinazione delle proprietà antiscivolo - Ambienti e zona di lavoro ad elevato rischio di scivolamento - Procedura di calpestio - Piano inclinato**

Descrizione della superficie

<input type="checkbox"/>	Liscia
<input type="checkbox"/>	Profiliata
<input type="checkbox"/>	Strutturata
<input checked="" type="checkbox"/>	Ruvida

**RISULTATI**

Angolo totale di accettazione - valore medio: **28°**

Spazio di spostamento (cm<sup>3</sup>/dm<sup>3</sup>): **-----**

**CLASSIFICAZIONE (BGR 181 - 10/2003)**

Gruppo di resistenza allo scivolamento: **R12**

Gruppo di valutazione dello spazio di spostamento: **-----**

The results reported refer only to the samples examined. No responsibility is assumed for the accuracy of the sampling unless it is done under our own supervision. The reproduction of this test report is only authorized in the form of a complete photographic copy. Our written approval is necessary for any partial reproduction. This test report consists of 1 page, this cover included.

**CERLABS EUROPEAN NETWORK OF NATIONAL CERAMIC LABORATORIES - ITALIAN MEMBER**

# Certificazioni

Certifications - Сертификация

**CENTRO CERAMICO**  
CENTRO DI RICERCA E SPERIMENTAZIONE PER L'INDUSTRIA CERAMICA

SEDE  
Via Martelli, 26 - 40138 Bologna  
Tel. 051 534015 - Fax 051 530085

**CERTI.CER.**  
LABORATORIO DI ZONA  
Via Valle d'Aosta, 1 - 41049 Sassuolo  
Tel. 0536 802154  
Part. IVA 0094778-0375

**SEZIONE CERAMICI INDUSTRIALI**  
Bologna, 12/02/13  
**Rapporto di prova N° 2436/13**  
su piastrelle di ceramica secondo UNI EN 87

Richiesto da: CERAMICA VALLELUNGA S.r.L. - S.S. Cassia Km 36,300  
Loc. Settevene 01036 NEPI (VT)

In data: 06/02/13

Per il prodotto: Piastrelle di ceramica smaltate di vari formati contrassegnate "Serie IN&OUT".

**UNI EN 101 - Determinazione della durezza superficiale secondo la scala Mohs**

Campioni	1	2	3
Durezza Mohs	9	9	9

The results reported refer only to the samples examined. No responsibility is assumed for the accuracy of the sampling unless it is done under our own supervision. The reproduction of this test report is only authorized in the form of a complete photographic copy. Our written approval is necessary for any partial reproduction. This test report consists of 1 page, this cover included.

**CERLABS EUROPEAN NETWORK OF NATIONAL CERAMIC LABORATORIES - ITALIAN MEMBER**

**CENTRO CERAMICO**  
CENTRO DI RICERCA E SPERIMENTAZIONE PER L'INDUSTRIA CERAMICA

SEDE  
Via Martelli, 26 - 40138 Bologna  
Tel. 051 534015 - Fax 051 530085

**CERTI.CER.**  
LABORATORIO DI ZONA  
Via Valle d'Aosta, 1 - 41049 Sassuolo  
Tel. 0536 802154  
Part. IVA 0094778-0375

**SEZIONE CERAMICI INDUSTRIALI**  
Bologna, 12/02/13  
**Rapporto di prova N° 2438/13**  
su piastrelle di ceramica secondo EN 14411 (ISO 13006)

Richiesto da: CERAMICA VALLELUNGA S.r.L. - S.S. Cassia Km 36,300  
Loc. Settevene 01036 NEPI (VT)

In data: 06/02/13

Per il prodotto: Piastrelle di ceramica smaltate di vari formati contrassegnate "Serie IN&OUT".

**EN ISO 10545 - 7 - Determinazione della resistenza all'abrasione superficiale Piastrelle smaltate**

STADIO DI ABRASIONE: PEI, variazione visibile a (gr): **>12000**

Soluzioni di prova	Classe di resistenza alle macchie (ISO 10545-14)				
	Campione 1	Campione 2	Campione 3	Campione 4	Campione 5
Verde cromo in olio leggero	5	5	5	5	5
Iodio (soluzione alcolica 13g/l)	5	5	5	5	5
Olio d'oliva (def. Olive Oil Agreement - 1979)	4	4	4	4	4

**CLASSIFICAZIONE** Classe di abrasione: **5**

Classe di resistenza alle macchie - Legenda

Classe di resistenza 1: macchia non rimossa.  
Classe di resistenza 2: macchia rimossa mediante immersione in idoneo solvente per 24 ore.  
Classe di resistenza 3: macchia rimossa mediante pulizia meccanica e detergente forte.  
Classe di resistenza 4: macchia rimossa mediante pulizia manuale detergente debole.  
Classe di resistenza 5: macchia rimossa mediante acqua corrente calda per 5 minuti.

The results reported refer only to the samples examined. No responsibility is assumed for the accuracy of the sampling unless it is done under our own supervision. The reproduction of this test report is only authorized in the form of a complete photographic copy. Our written approval is necessary for any partial reproduction. This test report consists of 1 page, this cover included.

**CERLABS EUROPEAN NETWORK OF NATIONAL CERAMIC LABORATORIES - ITALIAN MEMBER**

# Caratteristiche Tecniche

Technical Characteristics - Технические характеристики

**GRES PORCELLANATO IMPASTO COLORATO** **DIGITAL TECHNOLOGY** **CARATTERISTICHE TECNICHE**  
 Technical Characteristics / Caracteristiques Techniques / Technische Eigenschaften  
 CONFORME / ACCORDING TO / CONFORME / GEMÄß: ANSI 137,1 Impervious porcelain tiles

				IN	OUT
	<b>CARATTERISTICHE TECNICHE</b> TECHNICAL CHARACTERISTICS CARACTERISTIQUES TECHNIQUES TECHNISCHE EIGENSCHAFTEN	<b>METODO DI PROVA ASTM</b> TEST METHOD ASTM METHODE D'ESSAI ASTM PRÜFMETHODE ASTM	<b>REQUISITI PRESCRITTI</b> Required Value Valeur Requisite Vorgeschriebener Wert  ANSI 137,1	<b>VALORI</b> Value/Valeur/Wert <b>VALLELUNGA</b>  SMALTATO GLAZED GL	<b>VALORI</b> Value/Valeur/Wert <b>VALLELUNGA</b>  SMALTATO GLAZED GL
	<b>ASSORBIMENTO D'ACQUA</b> WATER ABSORPTION ABSORPTION D'EAU WASSERABSORPTION	EN-ISO 10545-3	0,5% (fully vitrified)	≤ 0,05	≤ 0,05
	<b>RESISTENZA ALLA ROTTURA</b> BREAKING MODULUS RÉSISTANCE À LA FLEXION BIEGEFESTIGKEIT	EN-ISO 10545-4	≥250 Pounds ≥113 Kg ≥1110 N	CONFORME Compliant	CONFORME Compliant
	<b>DUREZZA MOHS</b> MOHS HARDNESS DURETÉ MOHS HÄRTE MOHS	EN-ISO 101		MOHS 8	MOHS 9
	<b>RESISTENZA ALL'ABRASIONE</b> ABRASION RESISTANCE RÉSISTANCE À L'ABRASION ABRASIONSWIDERSTÄNDIGKEIT	EN-ISO 10545-7	NON RICHIESTO Not required	METODO DI PROVA ISO 10545-7 PEI IV	METODO DI PROVA ISO 10545-7 PEI V
	<b>RESISTENZA AGLI SBALZI TERMICI</b> THERMAL SHOCK RESISTANCE RÉSISTANCE AUX CHOC THERMIQUES TEMPERATURWECHSELBESTÄNDIGKEIT	ASTM C484	RICHIESTO required	RESISTENTE Resistant	RESISTENTE Resistant
	<b>RESISTENZA ALLO SCIVOLAMENTO</b> SLIP RESISTANCE RÉSISTANCE AU GLISSEMENT RUTSCHFESTIGKEIT	DIN 51130	RICHIESTO required	<b>R9</b>	<b>R12</b>
	<b>MISURA DEL COEFFICIENTE DI ATRITO STATICO</b> DETERMINATION OF STATIC COEFFICIENT OF FRICTION MISURE DE FRICTION STATIQUE MESSUNG VON STATISCHEN FRICTION	ASTM C1028	RICHIESTO required	≥ 0,60	BAGNATA 0,74 ASCIUTTA 0,85 WET 0,74 DRY 0,85
	<b>RESISTENZA ALL'ATTACCO CHIMICO</b> CHEMICAL RESISTANCE RÉSISTANCE CHIMIQUE CHEMISCHE BESTÄNDIGKEIT	EN-ISO 10545-13	NON RICHIESTO Not required	RESISTENTE Resistant	RESISTENTE Resistant
	<b>RESISTENZA AL GELO</b> FROST RESISTANCE RÉSISTANCE AU GEL FROSTBESTÄNDIGKEIT	EN-ISO 10545-12	NON RICHIESTO Not required	RESISTENTE Resistant	RESISTENTE Resistant
	<b>RESISTENZA ALLE MACCHIE</b> STAIN RESISTANCE RÉSISTANCE AUX TACHES FLECKENBESTÄNDIGKEIT	EN-ISO 10545-14	NON RICHIESTO Not required	RESISTENTE Resistant	RESISTENTE Resistant
	<b>SPESSORE</b> THICKNESS ÉPAISSEUR STÄRKE	ASTM C485 Planarit Warpage	≤ 1,0% Sui lati/On sides ≤ 0,75% Sulle diagonali/On diagonals	CONFORME Compliant	CONFORME Compliant
		ASTM C499 Dimensioni Dimensions	≤ 3,0% Sulle dimensioni nominali Of nominal dimensions ≤ 1,5% Differenza nel lotto tra valori min. e max./Difference in batch between min. and major values	CONFORME Compliant	CONFORME Compliant
		ASTM C499 Spessore Thickness	≤ 0,040 inch Differenza nel lotto tra spessore min. e max. Difference in batch between min. and major thickness	CONFORME Compliant	CONFORME Compliant
		ASTM C502 Parallelismo dei lati Wedging	≤ 1,0 %	CONFORME Compliant	CONFORME Compliant

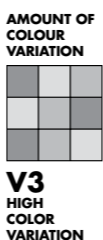

## IN & OUT

Imballaggi - packing - emballages - verpackung - Упаковки

Formato Size cm Format cm Формат cm	Pezzi/scatola Pièces/boîte Stück/Karton Изделий/коробку	Mq/scatola Sq.Mt./box Mq/boîte Qm/Karton M2/коробку	Kg/scatola Weight/box Poids/boîte Gewichte/Karton Kr/коробку	Scatole/pallet Box/pallet Boîte/pallet Karton/pallet Коробок/паллеты	Mq/pallet Sq.Mt./pallet Mq/pallet Qm/pallet M2/паллеты	Kg/pallet Weight/pallet Poids/pallet Gewichte/pallet Kr/паллеты	Spessore Thickness Épaisseur Stärke Толщина
59,5x59,5 IN Fondo Rett.	3	1,08	20,8	40	43,20	855	9,5
29,7x59,5 IN Fondo Rett.	6	1,08	19,60	48	51,84	960	9,5
30x60 Fondo IN&OUT	6	1,08	20,00	48	51,84	980	9,5
20x40 Fondo IN&OUT	13	1,04	18,70	54	56,16	1030	9,5
20x20 Fondo IN&OUT	26	1,04	18,33	54	56,16	1010	9,5
29,7x59,5 Muretto IN	4	-	-	-	-	-	
30x30 Mosaico IN&OUT	11	-	16,70	30	-	-	
9,5x40 Battiscopa	30	-	-	30	-	-	
58x36,2 Coda di Pavone	3	-	-	-	-	-	
20x12x4,5 Elemento ad "L"	8	-	-	36	-	-	





01036 NEPI (VT) Loc. Settevene Via dell'Industria n, 7 Tel. 0761 5291 - 4 linee - Fax. 0761 527156  
[www.vallelungacer.it](http://www.vallelungacer.it) - [www.vallelungaceramica.ru](http://www.vallelungaceramica.ru)