

ACCESSORI BAGNO QUADRO: B-UNO | B-DUE | BEETHOVEN | ZEHN | F-VOGUE | VOGUE LIGHT



6151 pag. 648
 PORTABICCHIERE SINGOLO DA PARETE
 WALL SINGLE GLASS HOLDER



6152 pag. 648
 PORTABICCHIERE SINGOLO D'APPOGGIO
 SINGLE STAND GLASS HOLDER



6153 pag. 648
 PORTASAPONE SINGOLO DA PARETE
 WALL SINGLE SOAP DISH



6153/1 pag. 648
 DISPENSER DA PARETE
 WALL DISPENSER



6154 pag. 648
 PORTASAPONE SINGOLO D'APPOGGIO
 SINGLE STAND SOAP DISH



6154/1 pag. 649
 DISPENSER D'APPOGGIO
 STAND DISPENSER



6159 pag. 649
 PIANTANA PORTASALVIETTE
 TOWEL RACK



6159/2 pag. 649
 PIANTANA CON DISPENSER, PORTASALVIETTE,
 PORTAROTOLO E PORTASCOPINO
 JOINTED SOAP DISPENSER TOWEL TOILET-ROLL
 AND TOILET-BRUSH RACK



6160 pag. 649
 PORTASALVIETTE A GANCIO
 TOWEL RACK BRACKET



6162/30 pag. 649
 PORTASALVIETTE DA 30 CM
 TOWEL RACK 30 CM



6162/45 pag. 650
 PORTASALVIETTE DA 45 CM
 TOWEL RACK 45 CM



6162/60 pag. 650
 PORTASALVIETTE DA 60 CM
 TOWEL RACK 60 CM



6163 pag. 650
 APPENDIABITO
 HANGER



6164 pag. 650
 PORTAROTOLO
 TOILET-ROLL HOLDER



6165 pag. 650
 PORTASCOPINO DA PARETE
 WALL TOILET-BRUSH HOLDER



6166 pag. 651
 PORTASCOPINO D'APPOGGIO
 STANDING TOILET-BRUSH HOLDER



ACCESSORI BAGNO QUADRO: B-UNO | B-DUE | BEETHOVEN | ZEHN | F-VOGUE | VOGUE LIGHT



6168 pag. **651**
 APPLIQUE
 APPLIQUE



6169 pag. **651**
 MENSOLA CRISTALLO
 CRYSTAL SHELF



6170/45 pag. **651**
 PORTASALVIETTE DOPPIO DA 45 CM
 DOUBLE TOWEL RACK 45 CM



6170/60 pag. **651**
 PORTASALVIETTE DOPPIO DA 60 CM
 DOUBLE TOWEL RACK 60 CM



6171 pag. **652**
 PORTASALVIETTE A RASTRELLIERA
 HAY TOWEL RACK



6172 pag. **652**
 SET A MURO C/SPECCHIO, PORTABICCHIERE,
 DISPENSER E PORTASALVIETTE
 WALL SET MIRROR GLASS HOLDER SOAP
 DISPENSER AND TOWEL RACK



6173 pag. **652**
 PORTASALVIETTE C/DISPENSER
 TOWEL RACK WITH DISPENSER

6151

PORTABICCHIERE SINGOLO DA PARETE

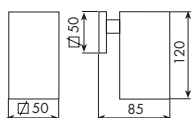

CROMATO		ALTRE FINITURE	
01-6151	€	XX-6151	€ x M*

6152

PORTABICCHIERE SINGOLO D'APPOGGIO

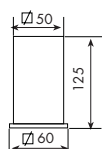

CROMATO		ALTRE FINITURE	
01-6152	€	XX-6152	€ x M*

6153

PORTASAPONE SINGOLO DA PARETE

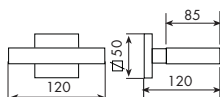

CROMATO		ALTRE FINITURE	
01-6153	€	XX-6153	€ x M*

6153/1

DISPENSER DA PARETE

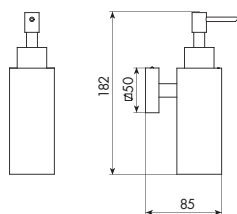

CROMATO		ALTRE FINITURE	
01-6153/1	€	XX-6153/1	€ x M*

6154

PORTASAPONE SINGOLO D' APPOGGIO

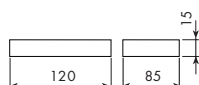

CROMATO		ALTRE FINITURE	
01-6154	€	XX-6154	€ x M*



ACCESSORI BAGNO
QUADRO

6154/1

DISPENSER D'APPOGGIO

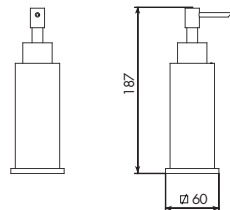

CROMATO	ALTRE FINITURE
01-6154/1 €	XX-6154/1 € x M*

6159

PIANTANA PORTASALVIETTE

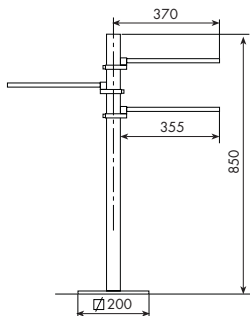

CROMATO	ALTRE FINITURE
01-6159 €	XX-6159 € x M*

6159/2

PIANTANA CON DISPENSER, PORTASALVIETTE, PORTAROTOLO E PORTASCIOPINO

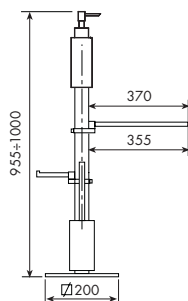

CROMATO	ALTRE FINITURE
01-6159/2 €	XX-6159/2 € x M*

6160

PORTASALVIETTE A GANCIO

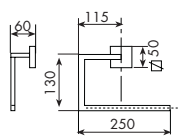

CROMATO	ALTRE FINITURE
01-6160 €	XX-6160 € x M*

6162/30

PORTASALVIETTE DA 30 CM

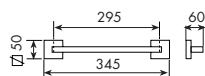

CROMATO	ALTRE FINITURE
01-6162/30 €	XX-6162/30 € x M*



ACCESSORI BAGNO QUADRO

6162/45

PORTASALVIETTE DA 45 CM



CROMATO		ALTRE FINITURE	
01-6162/45	€	XX-6162/45	€ x M*

6162/60

PORTASALVIETTE DA 60 CM



CROMATO		ALTRE FINITURE	
01-6162/60	€	XX-6162/60	€ x M*

6163

APPENDIABITO



CROMATO		ALTRE FINITURE	
01-6163	€	XX-6163	€ x M*

6164

PORTAROTOLO



CROMATO		ALTRE FINITURE	
01-6164	€	XX-6164	€ x M*

6165

PORTASOPINO DA PARETE

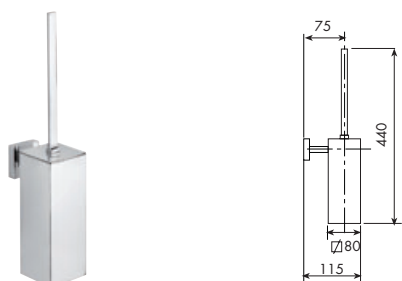

CROMATO		ALTRE FINITURE	
01-6165	€	XX-6165	€ x M*



ACCESSORI BAGNO
QUADRO

6166

PORTASOPINO D'APPOGGIO

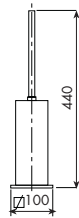

CROMATO

01-6166

€

ALTRE FINITURE

XX-6166

€

x M*

6168

APPLIQUE

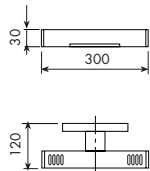

CROMATO

01-6168

€

ALTRE FINITURE

XX-6168

€

x M*

6169

MENSOLA CRISTALLO

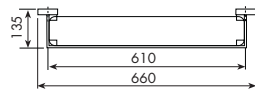

CROMATO

01-6169

€

ALTRE FINITURE

XX-6169

€

x M*

6170/45

PORTASALVIETTE DOPPIO DA 45 CM

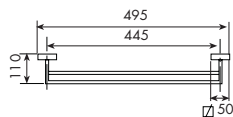

CROMATO

01-6170/45

€

ALTRE FINITURE

XX-6170/45

€

x M*

6170/60

PORTASALVIETTE DOPPIO DA 60 CM

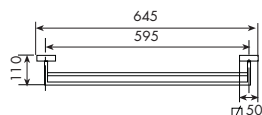

CROMATO

01-6170/60

€

ALTRE FINITURE

XX-6170/60

€

x M*

6171

PORTASALVIETTE A RASTRELLIERA

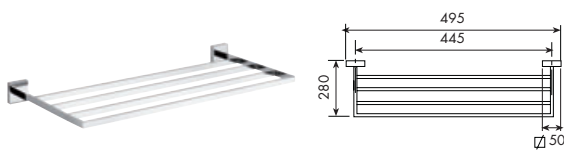

CROMATO		ALTRE FINITURE	
01-6171	€	XX-6171	€ x M*

6172

SET A MURO C/SPECCHIO, PORTABICCHIERE, DISPENSER E PORTASALVIETTE

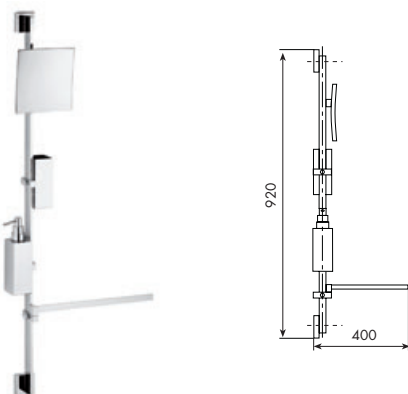

CROMATO		ALTRE FINITURE	
01-6172	€	XX-6172	€ x M*

6173

PORTASALVIETTE C/DISPENSER

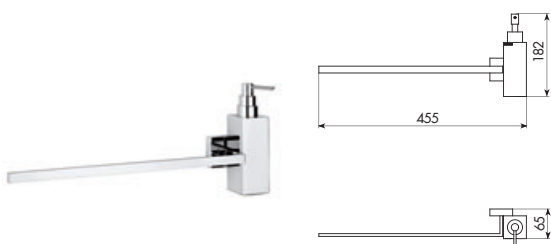

CROMATO		ALTRE FINITURE	
01-6173	€	XX-6173	€ x M*



