



Back2Back

Back2Back interprets three different types of natural stone.
 For each of them, the series uses the distinctive features both of the face, the side normally chosen to form the visible floor covering, and of the concealed underside, where exquisite details are revealed.
 Two sides of the same coin, with different personalities.

"... stone as muse and inspiration..."
 "... versatile materials, tough surfaces..."
 "... a selection of slabs for architectural projects..."

Back2Back interpretiert drei verschiedene Natursteine.
 Die typischen Merkmale der Frontseite, der noblen Sichtseite des Bodenbelags, und der Rückseite, die kostbare verborgene Details offenbart, rücken in den Mittelpunkt.
 Zwei Seiten einer Medaille mit unterschiedlichen Eigenschaften.

"... Stein als Inspiration..."
 "... vielseitige Materialien, strapazierfähige Oberflächen..."
 "... eine Auswahl von Platten für die Planung..."

La collection Back2Back interprète trois différents types de pierre naturelle.
 Pour chacune d'entre elles, les éléments distinctifs de la face visible, constituée de la partie noble de la pierre, et de la face cachée qui renferme des détails d'une élégance rare, ont été valorisés.
 Nous avons bel et bien affaire aux deux faces d'une même médaille possédant des identités dissemblables.

"... la pierre devenue muse inspiratrice..."
 "...des matériaux polyvalents, des surfaces résistantes..."
 "...une sélection de plaques servant à la conception..."

Back2Back interpreta tres tipos diferentes de piedras naturales.
 Se ha dado valor a los elementos distintivos de cada una de ellas, tanto de la parte frontal, el área noble que queda visible al pavimentar, como de la parte de atrás, una superficie oculta de la que se revelan preciosos detalles.
 Son dos caras de la misma medalla con caracteres diferentes.

"... la piedra como musa inspiradora..."
 "... materiales versátiles, superficies resistentes..."
 "... una selección de losas para proyectar..."

Back2Back по своему интерпретирует три разных типа натурального камня.
 Для каждого из них подчеркиваются характерные черты как на лицевой и обычно находящейся на поверхности части, так и на невидимой тыльной стороне, которая также открывает интересные детали.
 Две стороны одной и той же плиты, но с разным характером.

"... камень становится музой-вдохновительницей..."
 "... универсальные материалы, прочные поверхности..."
 "... ассортимент плит для создания проектов..."

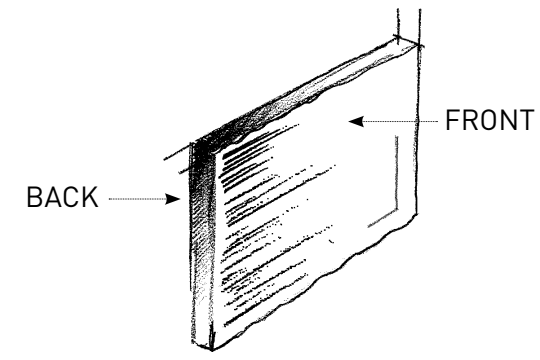

Back2Back interpreta tre tipologie di pietre naturali differenti.

Per ognuna sono stati valorizzati gli elementi distintivi sia del fronte, della parte nobile normalmente esposta a pavimento, che del retro, con la parte nascosta che rivela dettagli preziosi.
 Due facce della stessa medaglia con caratteri differenti.

"... la pietra come musa ispiratrice..."

"... materiali versatili, superfici resistenti..."

"... una selezione di lastre per progettare..."



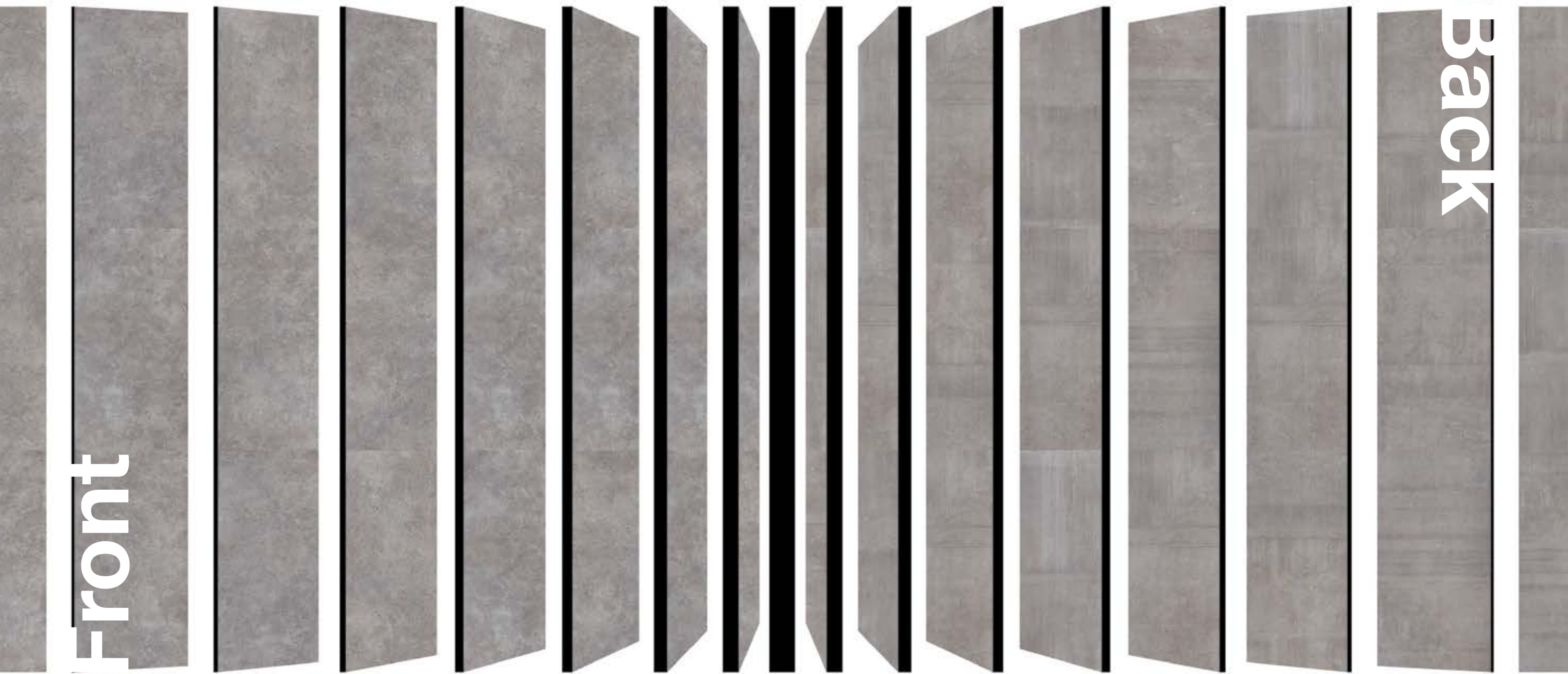

front

Back



Section 1

Back2Back Spaces

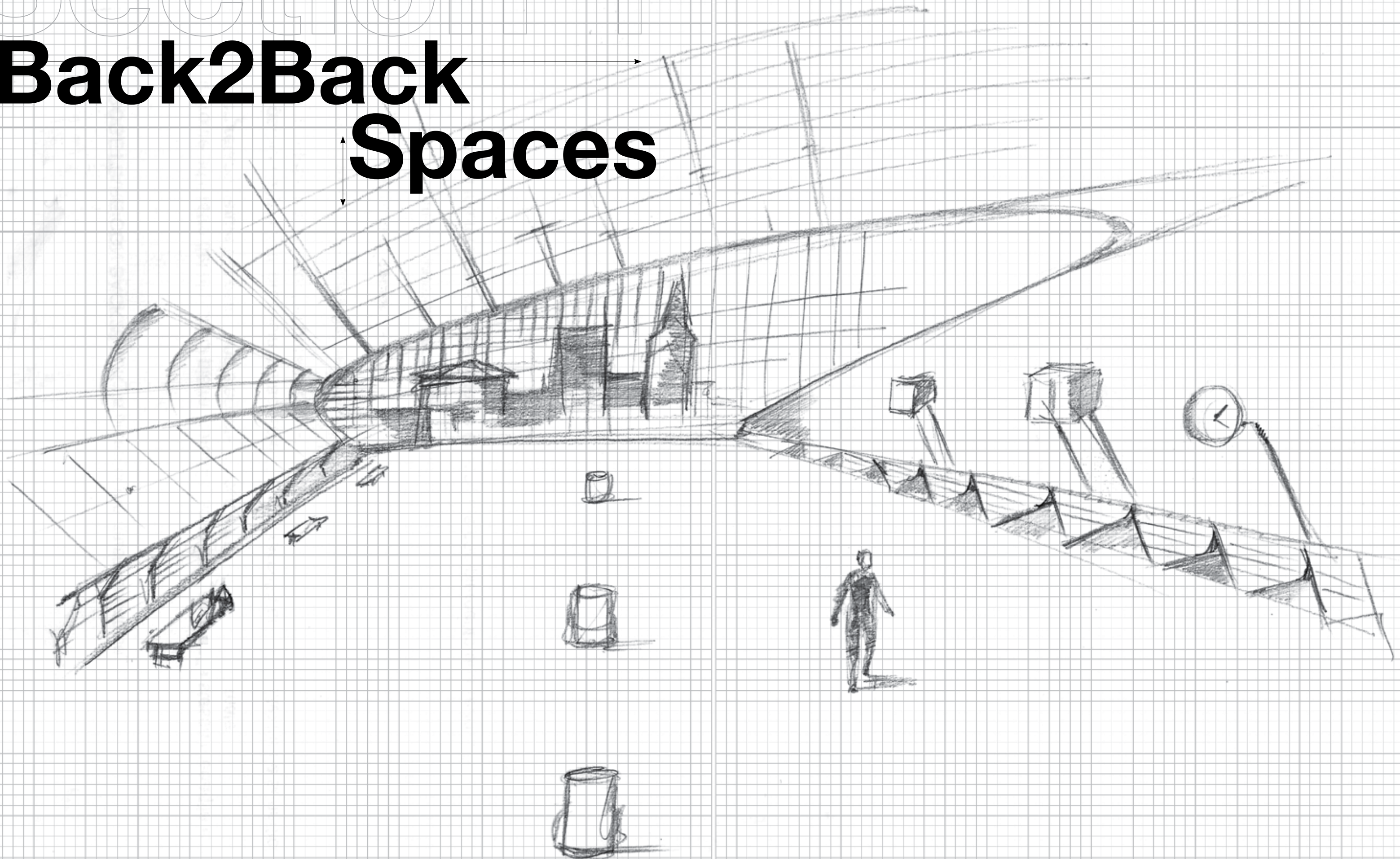

White

985H0R
BACK WHITE NAT. RETT.
60x120 - 23⁵/₈"x47¹/₄"

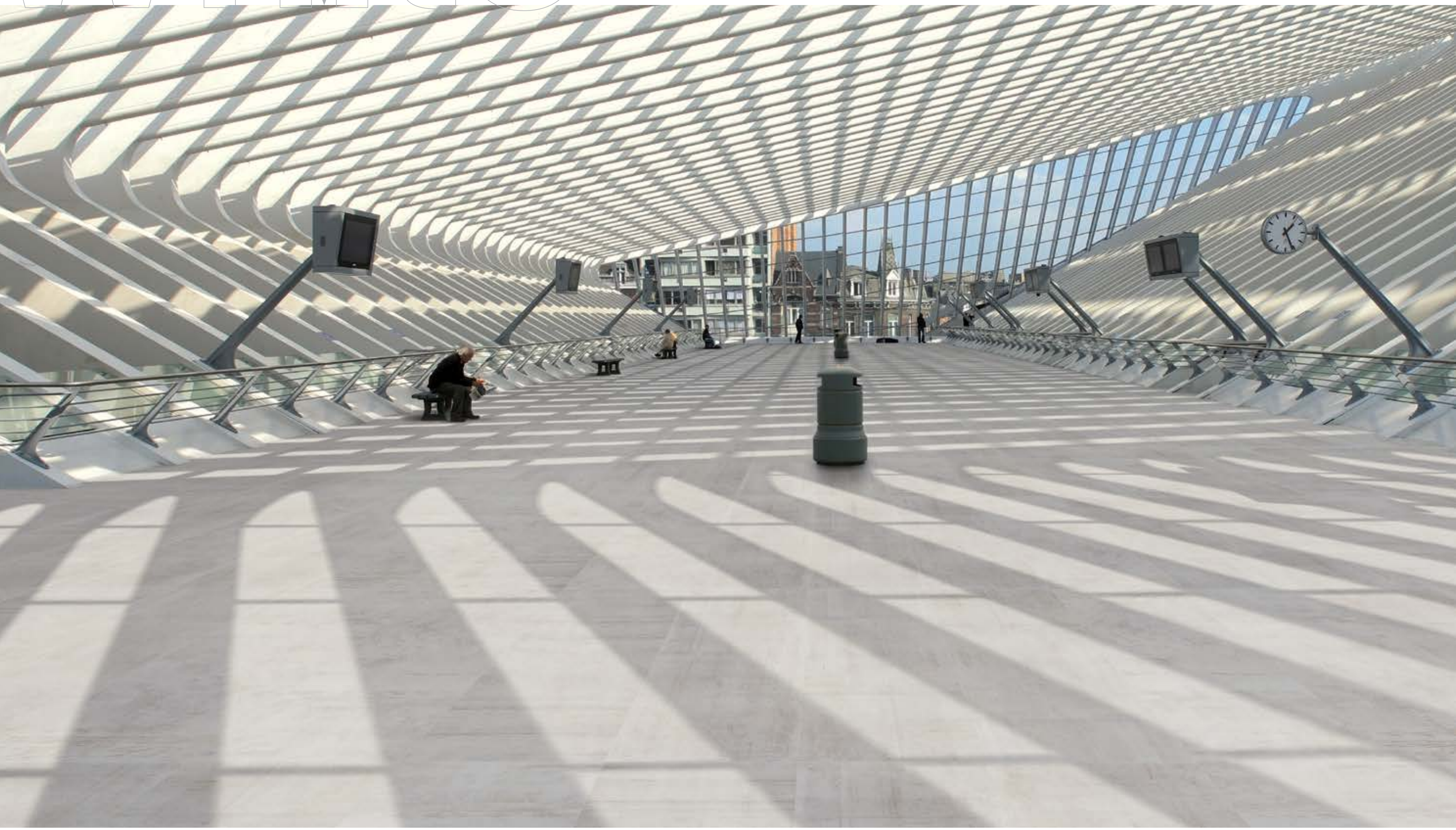
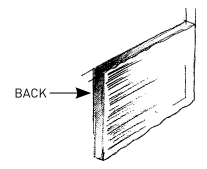

White Back

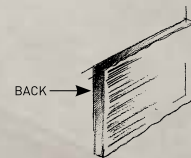
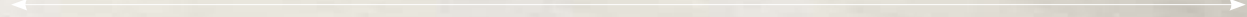

White

986H0P
FRONT FALL WHITE LAPP. RETT.
60x120 - 23⁵/₈"x47¹/₄"
985H0R
BACK WHITE NAT. RETT.
60x120 - 23⁵/₈"x47¹/₄"

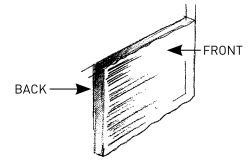

Front lappato

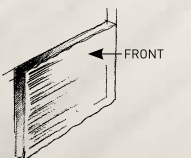

White

548H0R
BLEND FRONT/BACK WHITE NAT. RETT.
20x120 - 7^{7/8}"x47^{1/4}"

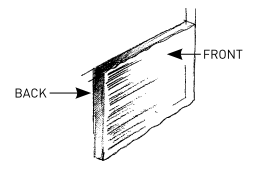

White Blend

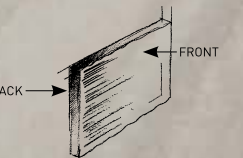

oeicide

985H1R
BACK BEIGE NAT. RETT.
60x120 - 23⁵/₈ x 47¹/₄"

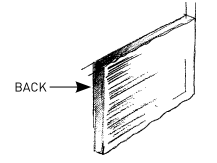

Back beige

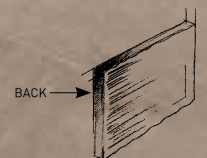

986H1R
FRONT POWDER BEIGE NAT. RETT.
60x120 - 23⁵/₈" x 47¹/₄"

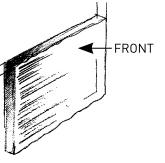

Front natural

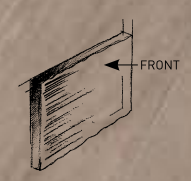

beige

548H1R
BLEND FRONT/BACK BEIGE NAT. RETT.
20x120 - 7^{7/8}"x47^{1/4}"

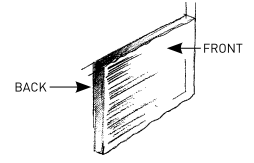

beigge Blend

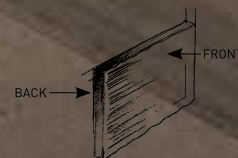

greve

985H8R
BACK GREY NAT. RETT.
60x120 - 23^{5/8}"x47^{1/4}"

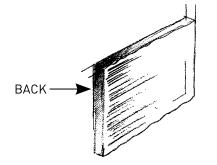

g r o Back

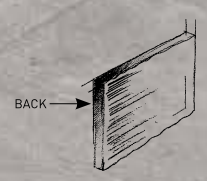

986H8R
FRONT MINERAL GREY NAT. RETT.
60x120 - 23^{5/8} x 47^{1/4}"

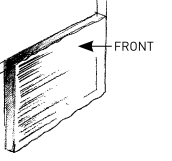

Front natural

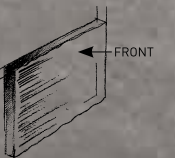

548H8R
BLEND FRONT/BACK GREY NAT. RETT.
20x120 - 7^{7/8}"x47^{1/4}"

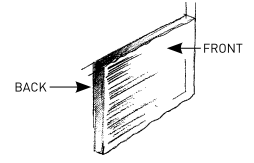

gloss Blend

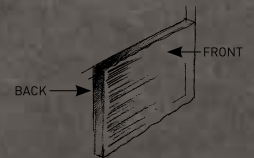

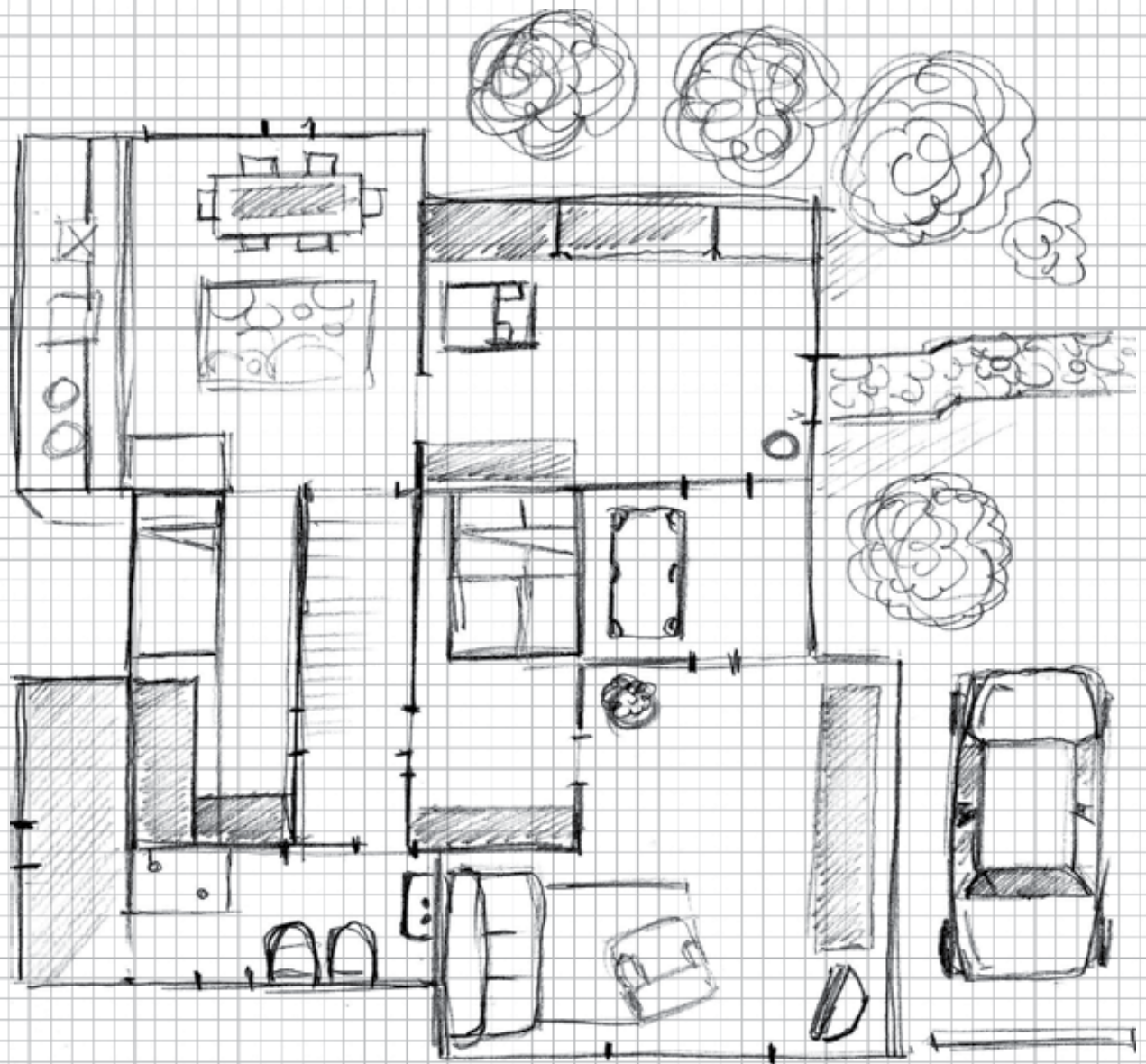

Section 2

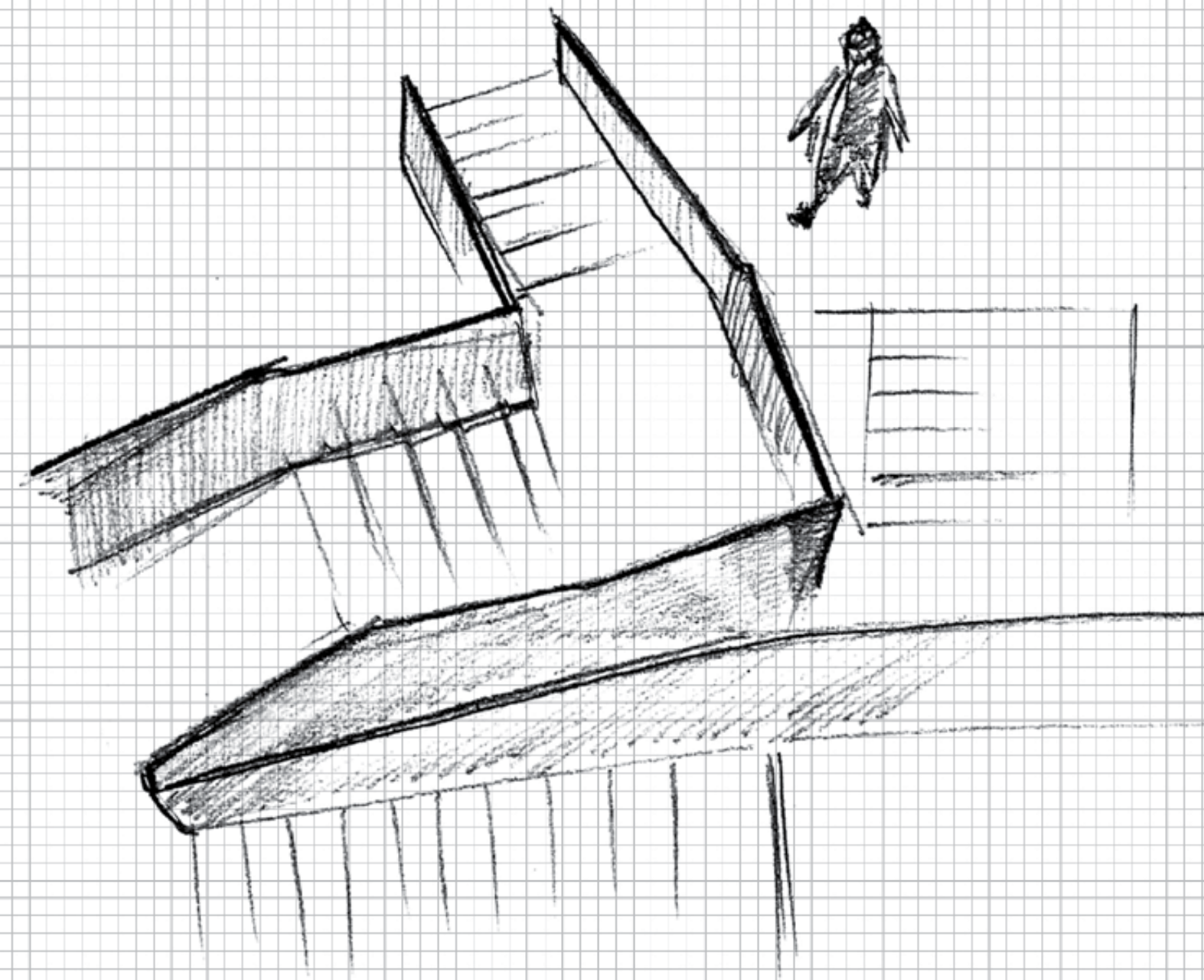

Back2Back Real loft

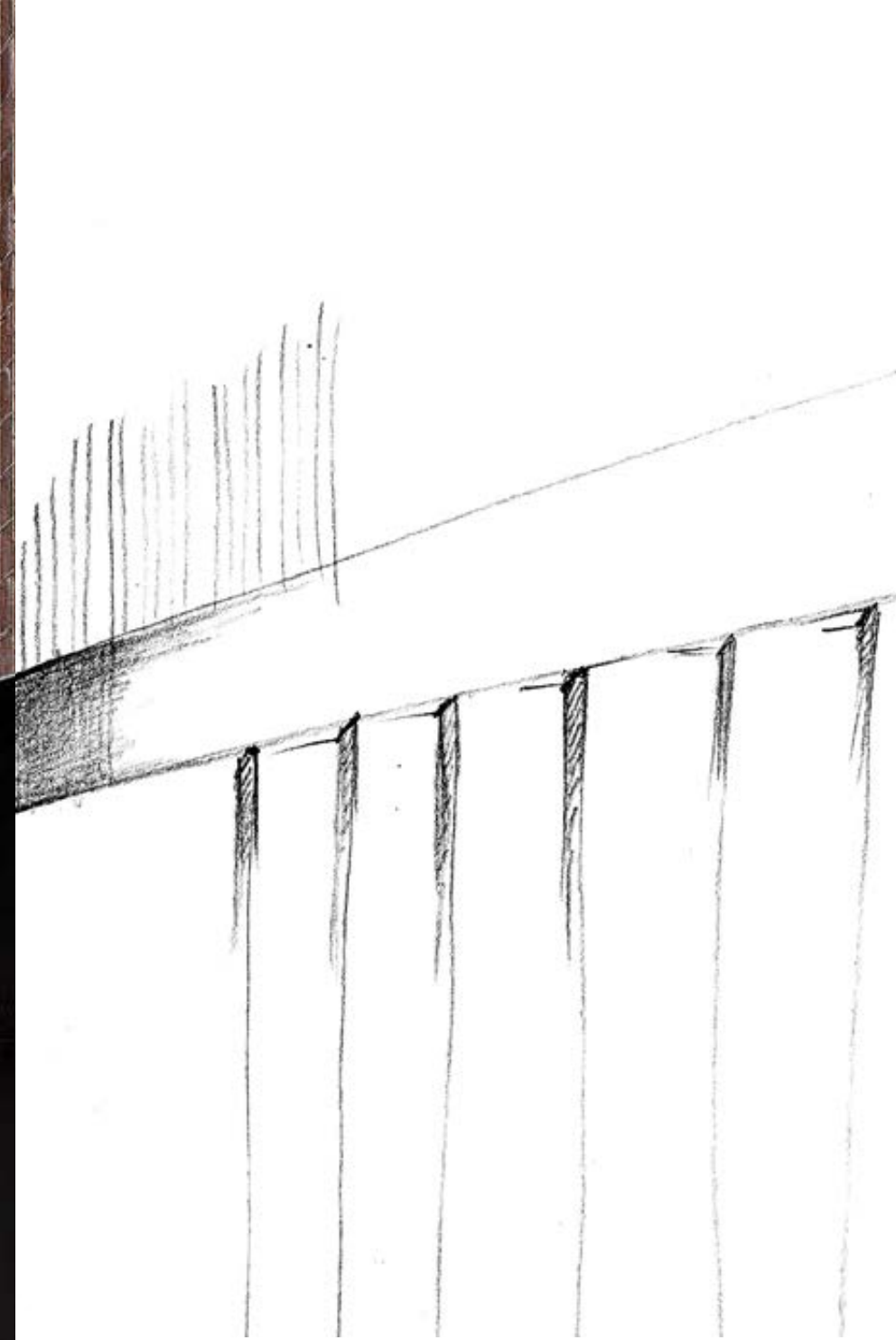

985H8R
BACK GREY RETT.
60x120 - 23^{5/8}x47^{1/4}"

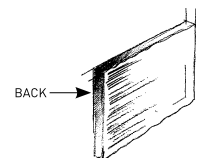

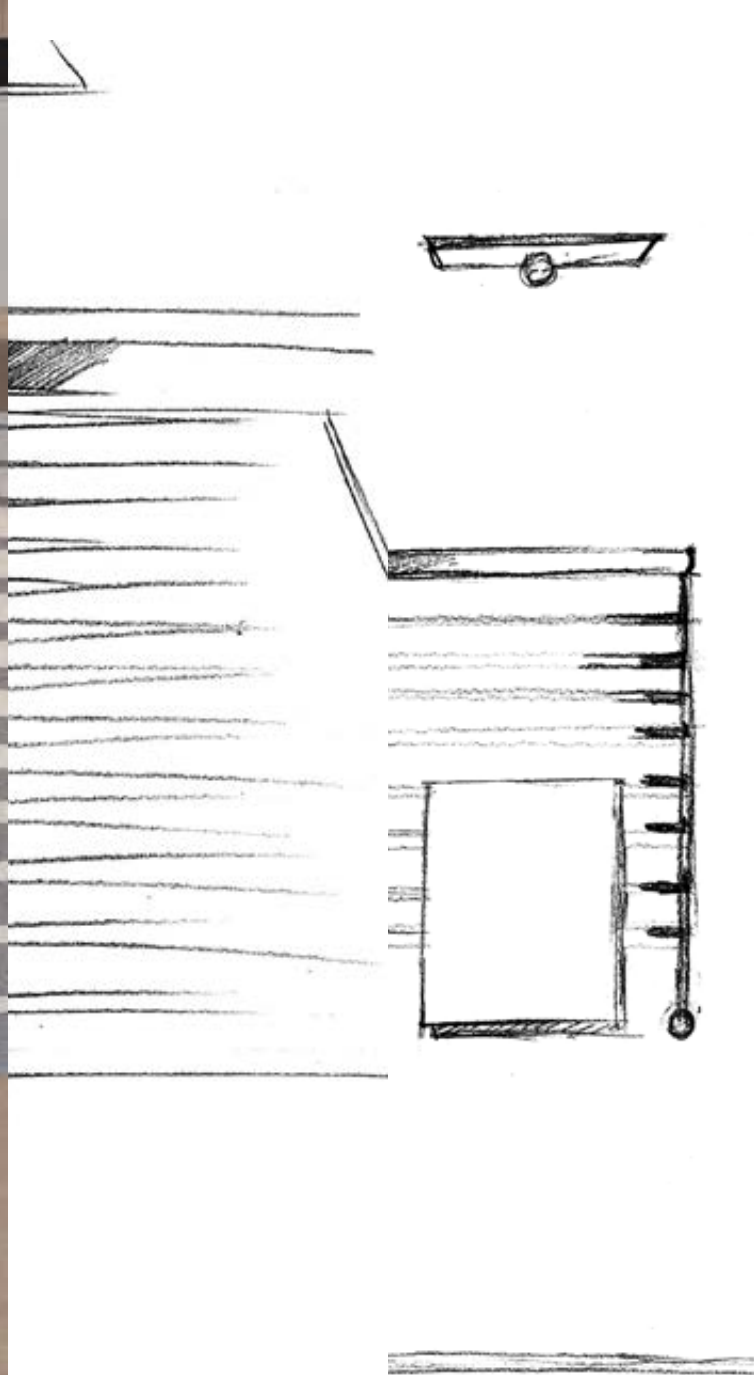

605H1R
 BACK BEIGE NAT. RETT.
 60x60 - 23^{5/8}"x23^{5/8}"

606H1R
 FRONT POWDER
 BEIGE NAT. RETT.
 60x60 - 23^{5/8}"x23^{5/8}"

606H1R
 FRONT POWDER
 BEIGE NAT. RETT.
 60x60 - 23^{5/8}"x23^{5/8}"

I305H1
 MOSAICO
 BACK2BACK BEIGE
 30x30 - 11^{13/16}"x11^{13/16}"

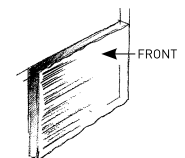
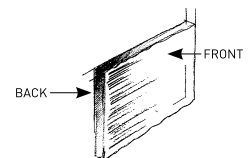

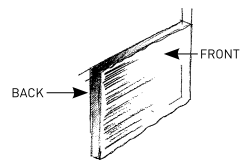
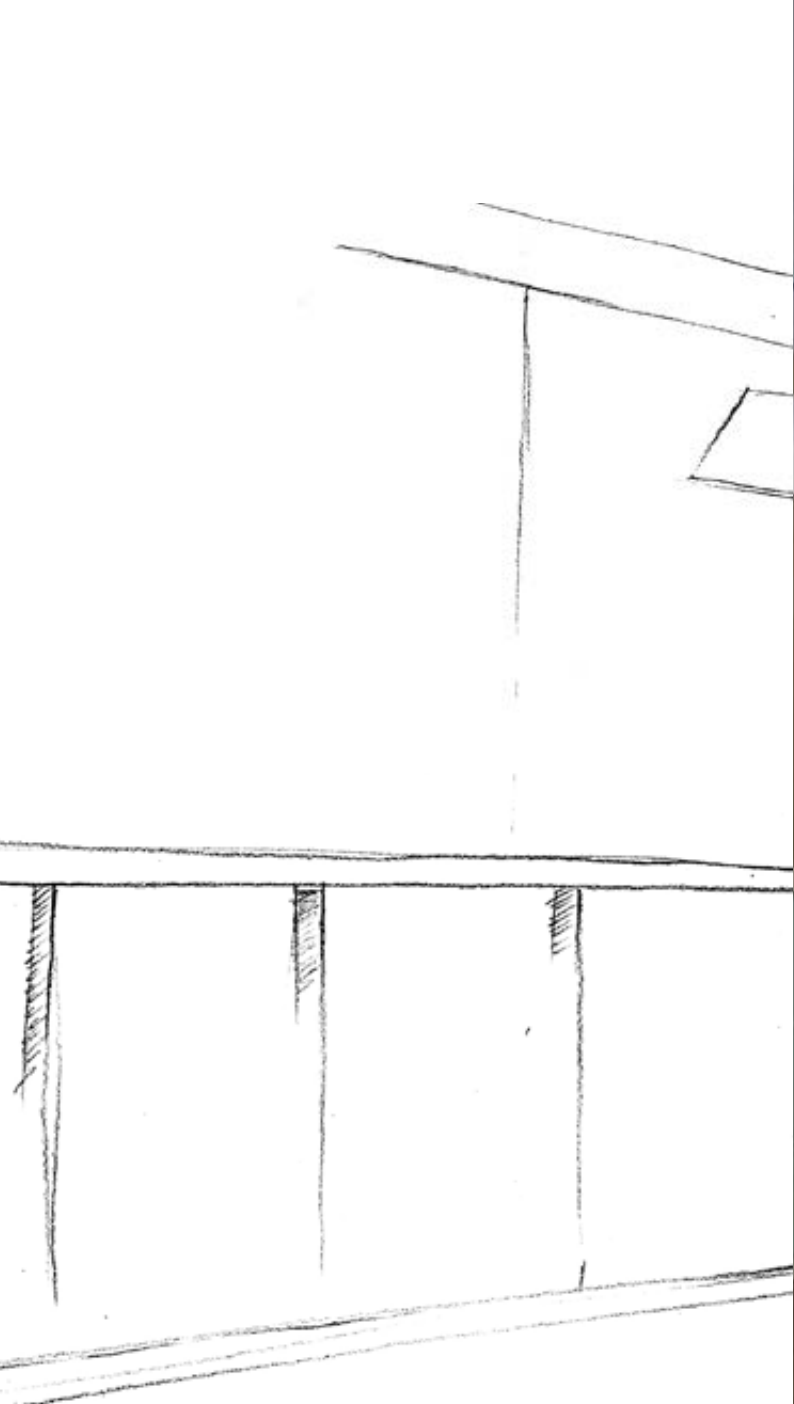

548H1R
BLEND FRONT/BACK BEIGE NAT. RETT.
20x120 - 7/8" x 47 1/4"

Forma e sostanza

ISPIRAZIONE:

Enormi lastre di pietra. Il fronte perfetto, pulito, disegnato; il retro polveroso, irregolare, segnato dalle lame degli utensili a taglio.

PRODOTTO:

Il fronte della lastra evidenzia le stratificazioni e le sedimentazioni minerarie, la grafica è nitida, precisa e pulita.

Il retro della stessa, appare sbiancato, impreciso nei dettagli grafici, minimale nel disegno.

Ogni colorazione presenta una grafica differente sia per il fronte che per il retro.

Il colore grigio interpreta la pietra moka brown proveniente dal Nord Africa, il beige la pietra star wood del Brasile, il bianco un'agata uruguiana reinterpretata.

SUPERFICIE:

Le 3 superfici di Back2Back sono state studiate e testate per garantire la massima resa tecnica ed estetica del prodotto.

Retro: conserva i segni del taglio sega e le imperfezioni causate dal trascinarsi delle lastre.

Fronte naturale: la grafica e la struttura tridimensionale compenetrano in modo da garantire un effetto estetico estremamente realistico e naturale.

Fronte lappato: la lappatura lucida segue la reale struttura della pietra.

GRAFICA:

Per ottenere la massima naturalezza, abbiamo fotografato ad alta risoluzione e riprodotto con tecnologia full HD una ventina di grandi lastre di pietra naturale.

Questa operazione è stata fatta sia per il "Front" che per il "Back".

Ergon ama le sfide: in Back2Back genio e materia si fondono per divenire progetto.

FORME ET SUBSTANCE

Inspiration

D'énormes plaques en pierre, dont la face visible est parfaite, propre et minutieusement dessinée et dont la face cachée, poussiéreuse et irrégulière, porte encore les traces des lames des outils de découpe, ont servi de base à l'élaboration de la collection.

Produit

La face visible des plaques en pierre fait ressortir les stratifications et les sédimentations minérales. Le graphisme est précis et parfaitement défini. La face cachée apparaît, quant à elle, comme lessivée et se distingue par des détails graphiques imprécis et un dessin sobre. Chaque coloris présente un graphisme différent tant pour la face visible que cachée.

La couleur grise renvoie à la pierre moka brown provenant de l'Afrique du Nord, la couleur beige à la pierre star wood du Brésil et la couleur blanche à une agate uruguayenne revisitée.

Surface

Les 3 surfaces de Back2Back ont été étudiées et testées afin de garantir le meilleur rendu technique et esthétique du produit. Face cachée : elle conserve les signes de la découpe du bois à la scie et les imperfections provoquées par le déplacement des plaques. Face visible naturelle : le graphisme et la structure

tridimensionnelle se fondent offrant un effet esthétique extrêmement réaliste et naturel. Face visible semi polie : le polissage brillant suit la structure réelle de la pierre.

Graphisme

Afin d'obtenir un effet naturel optimal, nous avons photographié, selon un procédé haute résolution, et reproduit, en faisant appel à une technique Full HD, une vingtaine de grandes plaques en pierre naturelle. Cette opération a été réalisée aussi bien pour la face cachée que visible des plaques.

Ergon aime relever les défis: dans Back2Back, génie et matière se fondent à merveille pour devenir une réalité tangible.

FORM AND SUBSTANCE

Inspiration:

Huge stone slabs. The flawless, smooth face with its fine patterning; the dusty, rough underside, with the marks left by the cutting tools.

Product:

In the face of the slab, the stratified, sedimented minerals are highlighted, with clear, precise patterning. The underside looks faded, its patterning and details minimal and confused. Each colour has a different patterning on both the face and the underside. Grey is inspired by moka brown stone from North Africa, beige by star wood stone from Brazil, and white is a reinterpreted Uruguayan agate.

Surfaces:

Back2Back's 3 surfaces have been developed and tested to ensure that the product delivers the best in terms of technical properties and appearance. Back: features the marks left by sawing and flaws caused when slabs are dragged across the ground. Natural front: the patterning and three-dimensional structure intermingle to provide an extremely realistic, natural effect. Honed front: the glossy honed finish follows the real structure of the stone.

Patterning:

For the most natural effect, we took high-resolution photographs of twenty or so large slabs of natural stone, and reproduced them in full HD. This procedure was carried out for both the front and the back.

Ergon loves challenges: in Back2Back genius and matter merge to become design.

FORM UND SUBSTANZ

Inspiration:

Riesengroße Steinplatten. Die Frontseite perfekt mit sauberer Zeichnung; die Rückseite stumpf, unregelmäßig, behaftet mit den Spuren der Schneidwerkzeuge.

Produkt:

Die Frontseite der Platte zeigt die mineralischen Schichtungen und Ablagerungen. Die Zeichnung ist klar, präzise und sauber. Ihre Rückseite erscheint gebleicht, mit unscharfen Musterungen und einer sparsamen Zeichnung. Jede Farbe weist ein unterschiedliches Muster auf der Front- und Rückseite auf. Die Farbe Grau interpretiert den Naturstein Moka Brown aus Nordafrika, Beige die Steinsorte Star Wood aus Brasilien und Weiß einen Achat aus Uruguay.

Oberfläche:

Die drei Oberflächen von Back2Back wurden so konzipiert, dass die besten technischen und optischen Eigenschaften des Produkts gewährleistet sind. Rückseite: Bewahrt die Sägeschneidspuren und die Verkratzungen infolge des Schiebens der Platten. Natürliche Frontseite: Die Zeichnung und die Tiefenoptik schaffen eine äußerst realistische, natürliche Ausstrahlung. Geläppte Frontseite: Die anpolierte Läppung folgt der tatsächlichen Steinstruktur.

Zeichnung:

Für eine möglichst natürliche Ausstrahlung haben wir rund zwanzig große Natursteinplatten mit hoher Auflösung fotografiert und mit Full HD-Technik reproduziert. Das galt sowohl für die Front- wie für die Rückseite.

Ergon sucht stets nach neuen Wegen: In Back2Back verbinden sich Geist und Materie zu einem Projekt.

FORMA Y SUBSTANCIA

Inspiración:

Enormes losas de piedra. La parte frontal perfecta, limpia, dibujada; la de atrás pulverulenta, irregular, marcada por las cuchillas de las herramientas de corte.

Producto:

La parte frontal de losa muestra las estratificaciones y sedimentaciones minerales; el diseño gráfico es neto, preciso, limpio. La parte de atrás ha empaldecido, los detalles gráficos se ven borrosos, el diseño es minimal. Cada coloración presenta un diseño gráfico diferente, tanto por delante como por detrás. El color gris interpreta la piedra moka brown procedente del norte de África, el beige la piedra star wood de Brasil, el blanco una agata uruguaya reinterpretada.

Superficie:

Las tres superficies de Back2Back se han estudiado y probado para garantizar el máximo rendimiento técnico y estético del producto.

Parte de atrás: conserva las huellas del corte de la sierra y las imperfecciones ocasionadas en las losas al ser arrastradas. Parte frontal natural: el diseño gráfico y la estructura tridimensional se compenetrán para garantizar un efecto estético extraordinariamente realista y natural. Parte frontal esmerilada: el esmerilado brillante sigue la estructura real de la piedra.

Diseño gráfico:

Para lograr la máxima naturalidad hemos fotografiado a alta resolución y reproducido con tecnología full HD una veintena de grandes losas de piedra natural. Esta operación se ha realizado tanto con la superficie como con la parte de atrás.

Ergon ama los desafíos: en Back2Back genio y materia se funden para convertirse en proyecto.

↑ Forma e sostanza

Вдохновение:

Очень крупные каменные плиты. У них безупречная лицевая сторона, чистая, словно вычерченная, а тыльная - пыльная, неровная, искаженная полотном режущего инструмента.

Продукт:

Лицевая сторона плиты показывает минеральные расслоения и отложения, графика - четкая, точная и чистая. Тыльная же сторона выглядит бледно, с размытыми графическими деталями, едва заметной текстурой. Каждый цвет предлагает разную графику как для лицевой, так и для тыльной стороны. Серый цвет воспроизводит камень тока brown из Северной Африки, бежевый цвет - бразильский камень star wood, а белый цвет - это новое толкование уругвайского агата.

Поверхность:

3 поверхности коллекции Back2Back были созданы и испытаны для обеспечения максимального технического и эстетического результата продукта. Тыльная сторона: сохраняет следы распила и неровности, образующиеся при перетаскивании плит. Натуральная лицевая сторона: графика и трехмерная текстура переплетаются друг с другом, гарантируя очень реалистичный и натуральный эффект. Притертая лицевая сторона: глянцевая притирка следует реальной структуре камня.

Графика:

Для обеспечения максимальной натуральности мы сняли с высоким разрешением и воспроизвели при помощи технологии full HD двадцать крупных плит из натурального камня. Такую операцию мы выполнили как для лицевой, так и для тыльной стороны.

Ergon любит принимать новые вызовы: в коллекции Back2Back гениальность и материя сливаются воедино и превращаются в проект.



Fall White
Front

Powder Beige
Front

Mineral Grey
Front

Back White
Back

Back Beige
Back

Back Grey
Back



60x120 (23^{5/8}"x47^{1/4}") **FRONT**
986H0R FALL WHITE NAT. RETT. ● 89
986H1R POWDER BEIGE NAT. RETT. ● 89
986H8R MINERAL GREY NAT. RETT. ● 89
986H0P FALL WHITE LAPP. RETT. ● 96
986H1P POWDER BEIGE LAPP. RETT. ● 96
986H8P MINERAL GREY LAPP. RETT. ● 96

60x60 (23^{5/8}"x23^{5/8}") **FRONT**
606H0R FALL WHITE NAT. RETT. ● 73
606H1R POWDER BEIGE NAT. RETT. ● 73
606H8R MINERAL GREY NAT. RETT. ● 73
606H0P FALL WHITE LAPP. RETT. ● 83
606H1P POWDER BEIGE LAPP. RETT. ● 83
606H8P MINERAL GREY LAPP. RETT. ● 83

30x60 (11^{13/16}"x23^{5/8}") **FRONT**
636H0R FALL WHITE NAT. RETT. ● 66
636H1R POWDER BEIGE NAT. RETT. ● 66
636H8R MINERAL GREY NAT. RETT. ● 66

20x120 (7^{7/8}"x47^{1/4}") **FRONT + BACK**
548H0R BLEND FRONT/BACK WHITE NAT. RETT. ● 95
548H1R BLEND FRONT/BACK BEIGE NAT. RETT. ● 95
548H8R BLEND FRONT/BACK GREY NAT. RETT. ● 95

60x120 (23^{5/8}"x47^{1/4}") **BACK**
985H0R BACK WHITE NAT. RETT. ● 89
985H1R BACK BEIGE NAT. RETT. ● 89
985H8R BACK GREY NAT. RETT. ● 89

60x60 (23^{5/8}"x23^{5/8}") **BACK**
605H0R BACK WHITE NAT. RETT. ● 73
605H1R BACK BEIGE NAT. RETT. ● 73
605H8R BACK GREY NAT. RETT. ● 73

30x60 (11^{13/16}"x23^{5/8}") **BACK**
635H0R BACK WHITE NAT. RETT. ● 66
635H1R BACK BEIGE NAT. RETT. ● 66
635H8R BACK GREY NAT. RETT. ● 66

Formati

SIZES / FORMATS / FORMATE / TAMAÑOS / ФОРМАТЫ

Front + Back = Blend°



20x120 (7⁷/₈"x47¹/₄")
548HOR BLEND FRONT/BACK
 WHITE NAT. RETT. ● 95



20x120 (7⁷/₈"x47¹/₄")
548H1R BLEND FRONT/BACK
 BEIGE NAT. RETT. ● 95



20x120 (7⁷/₈"x47¹/₄")
548H8R BLEND FRONT/BACK
 GREY NAT. RETT. ● 95

° Miscela pronta in scatola - Ready mixed in the box - Mélange prêt à poser vendu par boîte
 Fertige Mischung im Karton - Mezcla lista en caja - Готовая смесь в коробке

Pezzi speciali

TRIMS / PIECES SPECIALES / FORMTEILE
 PIEZAS ESPECIALES / СПЕЦИАЛЬНЫЕ ИЗДЕЛИЯ

Front

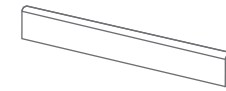

BATTISCOPIA - SKIRTING
 7,5x60 (2¹⁵/₁₆"x23⁵/₈")
 Pcs. Box. 15 - Ml. x Box 9

876HOR FALL WHITE NAT. RETT. ● 16
876H1R POWDER BEIGE NAT. RETT. ● 16
876H8R MINERAL GREY NAT. RETT. ● 16

876HOP FALL WHITE LAPP. RETT. ● 18
876H1P POWDER BEIGE LAPP. RETT. ● 18
876H8P MINERAL GREY LAPP. RETT. ● 18

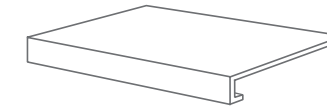

GRADONE - STEP
 33x60x3,2x3,2 (12¹⁵/₁₆"x23⁵/₈"x1¹/₄"x1¹/₄")
 Pcs. Box. 4 - Ml. x Box 2,4

CR6HOR FALL WHITE NAT. RETT. ● 89
CR6H1R POWDER BEIGE NAT. RETT. ● 89
CR6H8R MINERAL GREY NAT. RETT. ● 89

CR6HOP FALL WHITE LAPP. RETT. ● 92
CR6H1P POWDER BEIGE LAPP. RETT. ● 92
CR6H8P MINERAL GREY LAPP. RETT. ● 92

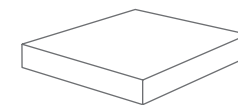

ANGOLARE DX / SX - CORNER TILE DX / SX
 33x33x3,2x3,2 (12¹⁵/₁₆"x12¹⁵/₁₆"x1¹/₄"x1¹/₄")
 Pcs. Box. 2 - Ml. x Box 0,66

A6HORCD / A6HORCS FALL WHITE NAT. RETT. ● 96
A6H1RCD / A6H1RCS POWDER BEIGE NAT. RETT. ● 96
A6H8RCD / A6H8RCS MINERAL GREY NAT. RETT. ● 96

A6HOPCD / A6HOPCS FALL WHITE LAPP. RETT. ● 100
A6H1PCD / A6H1PCS POWDER BEIGE LAPP. RETT. ● 100
A6H8PCD / A6H8PCS MINERAL GREY LAPP. RETT. ● 100

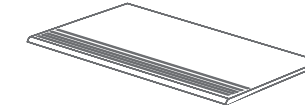

GRADINO - STAIR TREAD
 33x60 (12¹⁵/₁₆"x23⁵/₈")
 Pcs. Box. 6 - Ml. x Box 3,6

716HOR FALL WHITE NAT. RETT. ● 56
716H1R POWDER BEIGE NAT. RETT. ● 56
716H8R MINERAL GREY NAT. RETT. ● 56

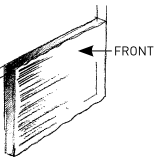

Decorati

DECORS / DECORS / DEKORE / DECORADOS / ДЕКОРЫ

Mosaico Back2Back*
 Tessera - Chip 2,8x2,8 (1¹/₈"x1¹/₈")

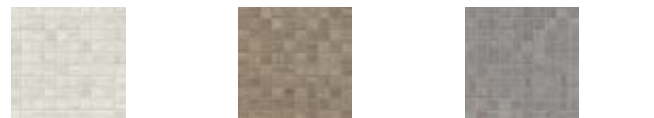

30x30 (11¹³/₁₆"x11¹³/₁₆")
I305HO WHITE NAT. ● 138
I305H1 BEIGE NAT. ● 138
I305H8 GREY NAT. ● 138

Muretto Back2Back*
 Tessera - Chip 14,8x2,8 (5¹³/₁₆"x1¹/₈")



30x30 (11¹³/₁₆"x11¹³/₁₆")
M305HO WHITE NAT. ● 130
M305H1 BEIGE NAT. ● 130
M305H8 GREY NAT. ● 130

* Su rete in fibra - On fibre mesh backing - Sur filet en fibre de verre
 Auf Glasfasernetz - Sobre malla de fibra - На волоконной сетке

Back

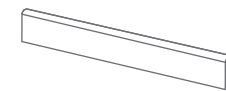

BATTISCOPIA - SKIRTING
 7,5x60 (2¹⁵/₁₆"x23⁵/₈")
 Pcs. Box. 15 - Ml. x Box 9

875HOR BACK WHITE NAT. RETT. ● 16
875H1R BACK BEIGE NAT. RETT. ● 16
875H8R BACK GREY NAT. RETT. ● 16

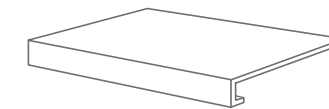

GRADONE - STEP
 33x60x3,2x3,2 (12¹⁵/₁₆"x23⁵/₈"x1¹/₄"x1¹/₄")
 Pcs. Box. 4 - Ml. x Box 2,4

CR5HOR BACK WHITE NAT. RETT. ● 89
CR5H1R BACK BEIGE NAT. RETT. ● 89
CR5H8R BACK GREY NAT. RETT. ● 89

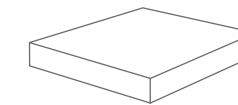

ANGOLARE DX / SX - CORNER TILE DX / SX
 33x33x3,2x3,2 (12¹⁵/₁₆"x12¹⁵/₁₆"x1¹/₄"x1¹/₄")
 Pcs. Box. 2 - Ml. x Box 0,66

A5HORC BACK WHITE NAT. RETT. ● 96
A5H1RC BACK BEIGE NAT. RETT. ● 96
A5H8RC BACK GREY NAT. RETT. ● 96

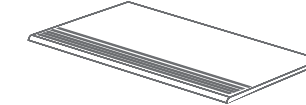

GRADINO - STAIR TREAD
 33x60 (12¹⁵/₁₆"x23⁵/₈")
 Pcs. Box. 6 - Ml. x Box 3,6

715HOR BACK WHITE NAT. RETT. ● 56
715H1R BACK BEIGE NAT. RETT. ● 56
715H8R BACK GREY NAT. RETT. ● 56



ELEMENTO A "L" - L SHAPED PIECE
 15x60x4,5 (5⁷/₈"x23⁵/₈"x1³/₄")
 Pcs. Box. 4 - Ml. x Box 2,4

995HOR BACK WHITE NAT. RETT. ● 37
995H1R BACK BEIGE NAT. RETT. ● 37
995H8R BACK GREY NAT. RETT. ● 37

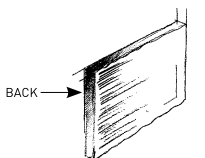

Back2Back



Dry - Pressed Ceramic Tiles ISO 13006 : 2012 Annex G - UNI EN 14411 : 2012 Annex G - Bla UGL

CARATTERISTICHE TECNICHE Technical Features - Caracteristiques Techniques Technische Eigenschaften - Caracteristicas Tecnicas - Технические Характеристики	NORMA Standard - Norme Norm - Norma - Норма	VALORI Value - Valeur Vorgabe - Valor - Средние
PLANARITÀ Flatness - Planéité - Ebenflächigkeit - Planiyud - Плоскостность	UNI EN ISO 10545/2	± 0,26% / ± 1,5mm
	ASTM C485 Warpage	
	Calibrated ± 0,75% (max ± 0,09 in)	-
	Rectified ± 0,40% (max ± 0,05 in-size ≤ 60cm) (max ± 0,07 in-size > 60cm)	± 0,25% (max ± 0,05 in-size ≤ 60cm) (max ± 0,07 in-size > 60cm)
ASSORBIMENTO D'ACQUA - Valore medio in % Water absorption - Average value expressed in % Absorption d'eau - Valeur moyenne en % Wasseraufnahme - Durchschnittswert in % Absorción de agua - Valor medio en % - Поглощение воды	UNI EN ISO 10545/3 ≤ 0,5 % ASTM C373	Conforme Compliant
RESISTENZA ALLA FLESSIONE Modulus of rupture - Resistance a la flexion Biegefestigkeit - Resistencia a la flexion - Прочность на изгиб	UNI EN ISO 10545/4	≥ 50 N/mm ²
FORZA DI ROTTURA Breaking strength - Résistance à la rupture Bruchlast - Resistencia a la rotura - Разрывное усилие	UNI EN ISO 10545/4 ASTM C648	≥ 2000 N 700 LBS
RESISTENZA AL GELO Frost resistance - Résistance au gel - Frostbeständigkeit Resistencia a las heladas - Морозостойкость	UNI EN ISO 10545/12 ASTM C1026	Conforme Unaffected
RESISTENZA CHIMICA ad alte e basse concentrazioni di acidi e basi Chemical resistance to high and low acid and basic concentrations Résistance chimique aux hautes et basses concentrations d'acides et de bases Chemikalienfestigkeit bei hohen und niedrigen Konzentrationen von Säuren und Basen Resistencia química con concentraciones altas y bajas de ácidos y bases Химическая стойкость к высоким и низким концентрациям кислот и щелочей	UNI EN ISO 10545/13 ASTM C-650	UA - ULA - UHA Unaffected
RESISTENZA ALLE MACCHIE Stain resistance - Résistance aux taches - Fleckenbeständigkeit Resistencia a las manchas - Стойкость к образованию пятен	UNI EN ISO 10545/14 CTI 81-7D	5 No Evident Variation
	DIN 51130 DIN 51097 ANSI A 137.1 - 2012 DCOF (Section 9.6) B.C.R.A.	NAT R10 B (A+B) Dry: ≥ 0,42 Wet: ≥ 0,42 ≥ 0,40
		LAPP - - Dry: ≥ 0,42 Wet: ≥ 0,42 -

Per maggiori chiarimenti sui dati tecnici e sulla garanzia consultare il catalogo generale in vigore.

For further information on technical specifications, please consult our up-dated general catalogue.

Pour toutes informations supplémentaires sur les données techniques et sur les garanties, veuillez consulter le catalogue general en vigueur.

Für weitere Informationen über technische Daten und Garantie beziehen sie sich bitte auf den aktuellen Gesamtkatalog.

Para ulteriores informaciones sobre los datos técnicos y la garantía, vease el catalogo general en vigor.

Более подробную информацию о технических данных и гарантии смотрите в действующем сводном катал.

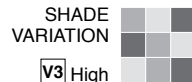

IMBALLI E PESI Packing and weight - Emballages et poids - Verpackung und gewicht - Embalajes y pesos - УПАКОВКА И ВЕС									
Articolo Item	Formato (cm) Size (cm)	Spessore (mm) Thickness (mm)	Pz. x Mq. Pieces x Sqm	Pz. x Scat. Pieces x Box	Mq. x Scat. Sqm x Box	Peso x Scat. (Kg) Weight x Box (Kg)	Scat. x Pal. Boxes x Pal.	Mq. x Pal. Sqm x Pal.	Peso x Pal. (Kg) Weight x Pal. (Kg)
Reference	Format (cm)	Epaisseur (mm)	Pcs / M ²	Pcs / Bte	M ² / Bte	Poids / Bte (Kg)	Bte / Pal.	M ² / Pal.	Poids / Pal. (Kg)
Artikel	Format (cm)	Stärke (mm)	Stk. x Qm	Stk. x Krt.	Qm x Krt.	Gewicht x Krt. (Kg)	Krt. x Pal.	Qm x Pal.	Gewicht x Pal. (Kg)
Artículo	Tamaño (cm)	Espesor (mm)	Pzs x Mc.	Pzs x Caja	Mc. x Caja	Peso x Caja (Kg)	Cajas x Pal.	Mc. x Pal.	Peso x Pal. (Kg)
Артикула	Формат (cm)	Толщина (mm)	Шт. x Кв.М.	Шт. x Кор.	Кв.М. x Кор.	Вес x Кор. (Kg)	Кор. x Подд.	Кв.М x Подд.	Вес x Подд (Kg)
986H_R/P 985H_R	60x120	10	1,39	2	1,440	34,23	22	31,68	753
548H_R	20x120	10	4,17	4	0,960	23,50	36	34,56	846
606H_R/P 605H_R	60x60	10	2,78	3	1,080	26,50	40	43,20	1060
636H_R 635H_R	30x60	10	5,56	6	1,080	26,50	40	43,20	1060
I305H_	30x30	10	11,11	5	0,450	10,80	-	-	-
M305H_	30x30	10	11,11	5	0,450	10,80	-	-	-

Ergon

a brand of EMILCERAMICA S.p.A.

UNI EN ISO 9001:2008
UNI EN ISO 14001:2004
BS OHSAS 18001:2007



SISTEMI DI GESTIONE
CERTIFICATI



CERTIQUALITY
MEMBRO DELLA
FEDERAZIONE CISO



CONFINDUSTRIA
PER LA SOSTENIBILITÀ





a brand of Emilceramica S.p.A.
Via Ghiarola Nuova 29
41042 Fiorano Modenese (Mo) - Italia
Tel. +39 0536 835111
Fax Italia: +39 0536 835955
Fax Export: + 39 0536 835358
info@emilceramicagroup.it
www.ergontile.com