

Blox



Concrete

COLOR BODY PORCELAIN TILE

GRES PORCELLANATO COLORATO IN MASSA / GRÈS CÉRAME TEINTÉ DANS LA MASSE / EINGEFÄRBTES FEINSTEINZEUG
GRES PORCELÁNICO COLOREADO EN MASA / КЕРАМОГРАНИТ ОКРАШЕННЫЙ В МАССЕ / 彩色通体瓷质砖

CONFORME / ACCORDING TO / CONFORME / KONFORM / CONFORME / СООТВЕТСТВУЕТ / 合格
UNI EN 14411 - G Bla



FORMATI

SIZES / FORMATS / FORMATE / FORMATOS / ФОРМАТЫ / 规格

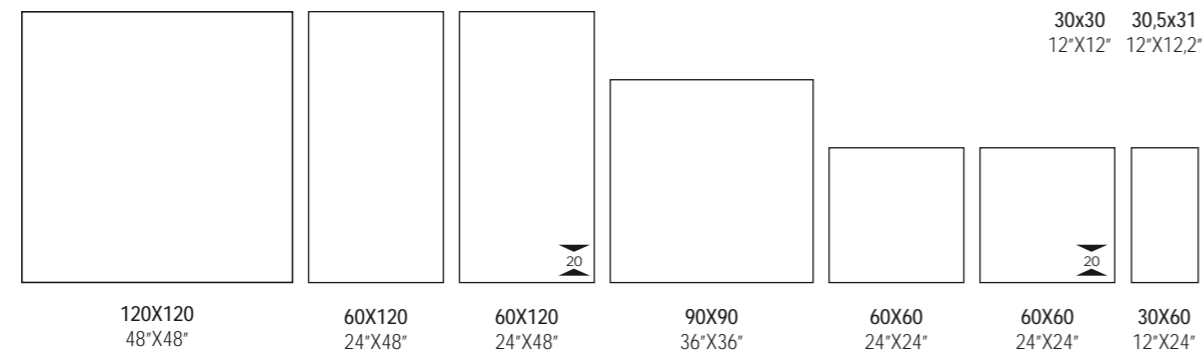

SUPERFICI

SURFACES / SURFACES / OBERFLÄCHEN / SUPERFICIES / ПОВЕРХНОСТИ / 表面



COLORI

COLOURS / COULEURS / FARBEN / COLORES / ЦВЕТА / 颜色

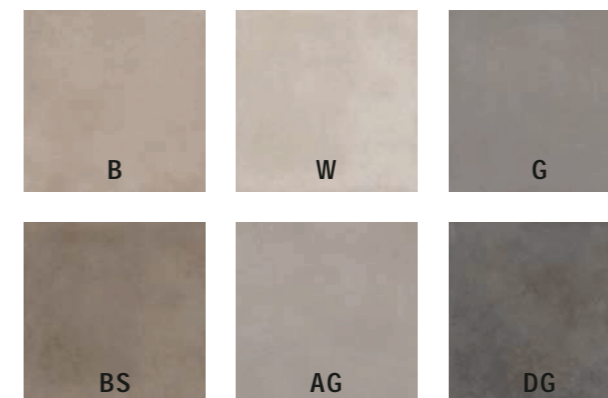



Concrete

Blox



BLOX6 120W RM



BLOX 90BS RM

Concrete



Concrete



Concrete

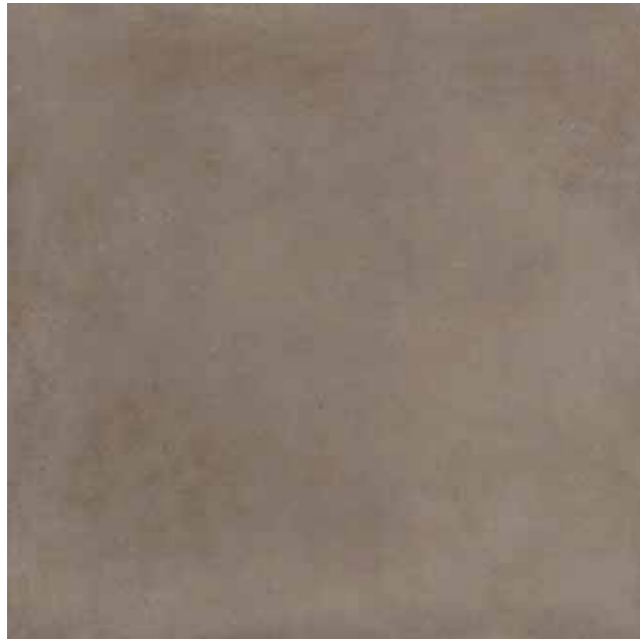

BS



B



W



AG

Concrete

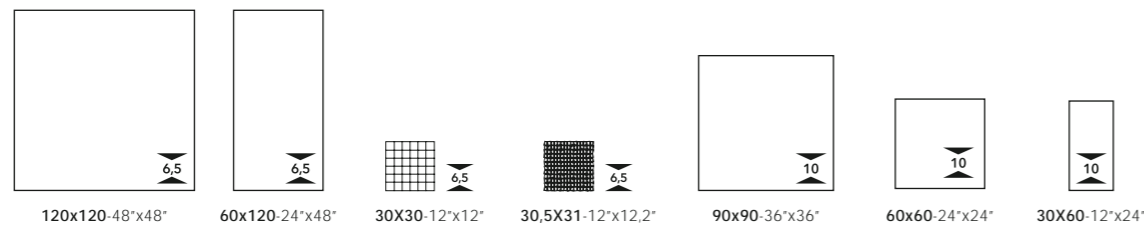

	N		BLOX6 120BS RM	BLOX6 12BS RM	MK.BLOX6 30BS	MK.BLOX6 BS	BLOX 90BS RM	BLOX 60BS RM	BLOX 36BS RM
	N		BLOX6 120B RM	BLOX6 12B RM	MK.BLOX6 30B	MK.BLOX6 B	BLOX 90B RM	BLOX 60B RM	BLOX 36B RM

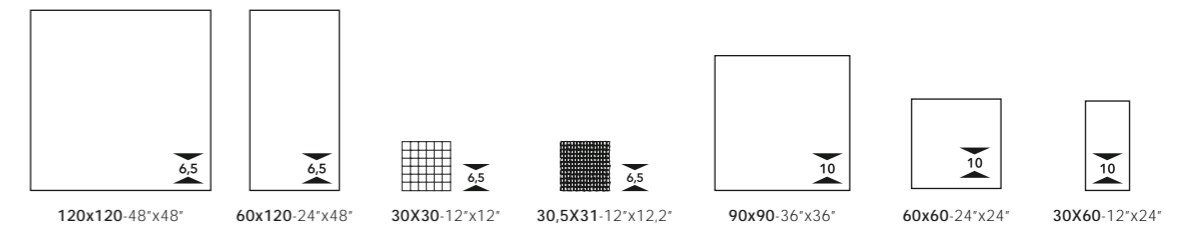

	N		BLOX6 120W RM	BLOX6 12W RM	MK.BLOX6 30W	MK.BLOX6 W	BLOX 90W RM	BLOX 60W RM	BLOX 36W RM
	N		BLOX6 120AG RM	BLOX6 12AG RM	MK.BLOX6 30AG	MK.BLOX6 AG	BLOX 90AG RM	BLOX 60AG RM	BLOX 36AG RM



G



DG



BLOX1 60W RM
60x60-24"x24"



BLOX2 60AG RM
60x60-24"x24"



Concrete

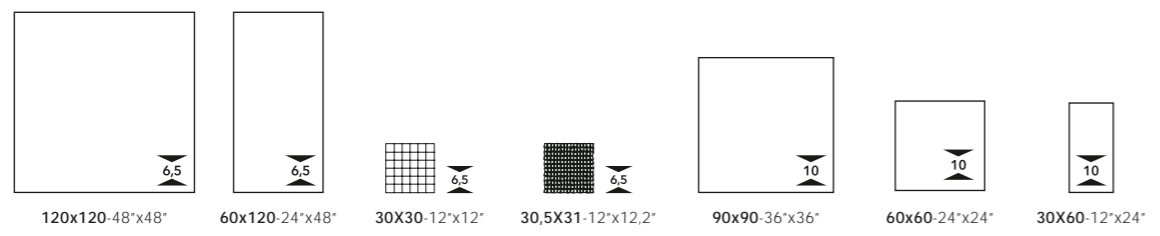

	N		BLOX6 120G RM	BLOX6 12G RM	MK.BLOX6 30G	MK.BLOX6 G	BLOX 90G RM	BLOX 60G RM	BLOX 36G RM
	N		BLOX6 120DG RM	BLOX6 12DG RM	MK.BLOX6 30DG	MK.BLOX6 DG	BLOX 90DG RM	BLOX 60DG RM	BLOX 36DG RM

PEZZI SPECIALI

SPECIAL PIECES / PIÈCES SPÉCIALES / SONDERPREISE / PIEZAS ESPECIALES / СПЕЦИАЛЬНЫЕ ЭЛЕМЕНТЫ / 特制件

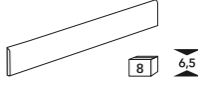
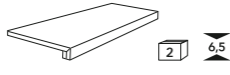
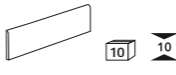
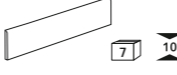
				
	6X120-2.4*X48° △	120X32,5-48*X12.8° △	6X60-2.4*X24° △	6X90-2.4*X36° △
BS	BLOX6 BT120BS	BLOX6 G120BS	BLOX BT60BS	BLOX BT90BS
B	BLOX6 BT120B	BLOX6 G120B	BLOX BT60B	BLOX BT90B
W	BLOX6 BT120W	BLOX6 G120W	BLOX BT60W	BLOX BT90W
AG	BLOX6 BT120AG	BLOX6 G120AG	BLOX BT60AG	BLOX BT90AG
G	BLOX6 BT120G	BLOX6 G120G	BLOX BT60G	BLOX BT90G
DG	BLOX6 BT120DG	BLOX6 G120DG	BLOX BT60DG	BLOX BT90DG

IMBALLI

PACKAGING / EMBALLAGES / VERPACKUNGEN / EMBALAJES / УПАКОВКИ / 包装

FORMATO NOMINALE NOMINAL SIZE	BORDO EDGE	SPESSORE THICKNESS	BOX			PALLET		
			PZ/BOX PCS/BOX	MO/BOX SM/BOX	KG/BOX KG/BOX	BOX/PALLET BOXES/PALLET	MO/PALLET SM/PALLET	KG/PALLET KG/PALLET
120X120-48°X48°	RECTIFIED	6,5	2	2,88	45,28	30	86,40	1378,50
60X120-24°X48°	RECTIFIED	6,5	4	2,88	45,29	16	46,08	744,67
30,5X31-12°X12,2° MOSAIC	RECTIFIED	6,5	6	0,57	6,74	72	40,85	505,15
30X30-12°X12° MOSAIC	RECTIFIED	6,5	6	0,54	7,91	72	38,88	589,16
60X60-24°X24°	RECTIFIED	10	3	1,08	24,32	40	43,20	992,86
30X60-12°X24°	RECTIFIED	10	6	1,08	23,91	40	43,20	976,33
90X90-36°X36°	RECTIFIED	10	2	1,62	37,55	22	35,64	846,10

CARATTERISTICHE TECNICHE SPECIFICHE

TECHNICAL FEATURES SPECIFICATIONS / CARACTÉRISTIQUES TECHNIQUES SPÉCIFIQUE / TECHNISCHE EIGENSCHAFTEN
CARACTERÍSTICAS TÉCNICAS ESPECÍFICAS / ТРЕБУЕМЫЕ ТЕХНИЧЕСКИЕ ХАРАКТЕРИСТИКИ / 特殊技术规格

BLOX	DIN 51130 (R)	DIN 51097 (A+B+C)	BCR REP. CEC 6/81		DM 14/6/89 N. 236		PENDULUM TEST BS (INGLESE)	PENDULUM TEST AS/NZS 4856:2004 (AUSTRALIANO)	PENDULUM TEST UNE ENV 12633:2003 (SPAGNOLO)	BOT 3000 (DCOF)
			G.A.	G.B.	C.A.	G.B.				
BLOX	R10	A+B	>0.4	>0.4	>0.4	>0.4	>36	>35	2	>0,42

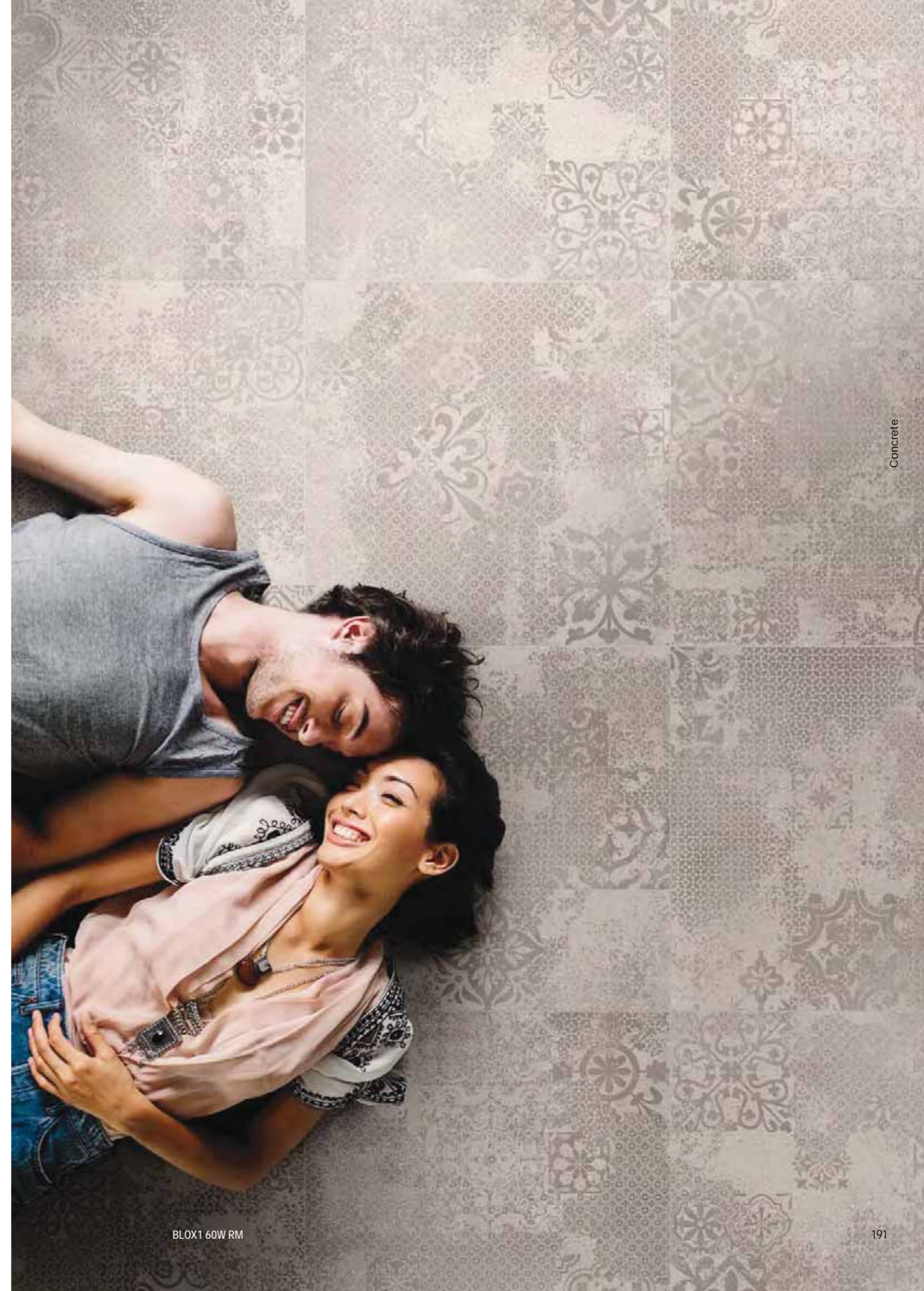

Concrete



BLOX1 60W RM

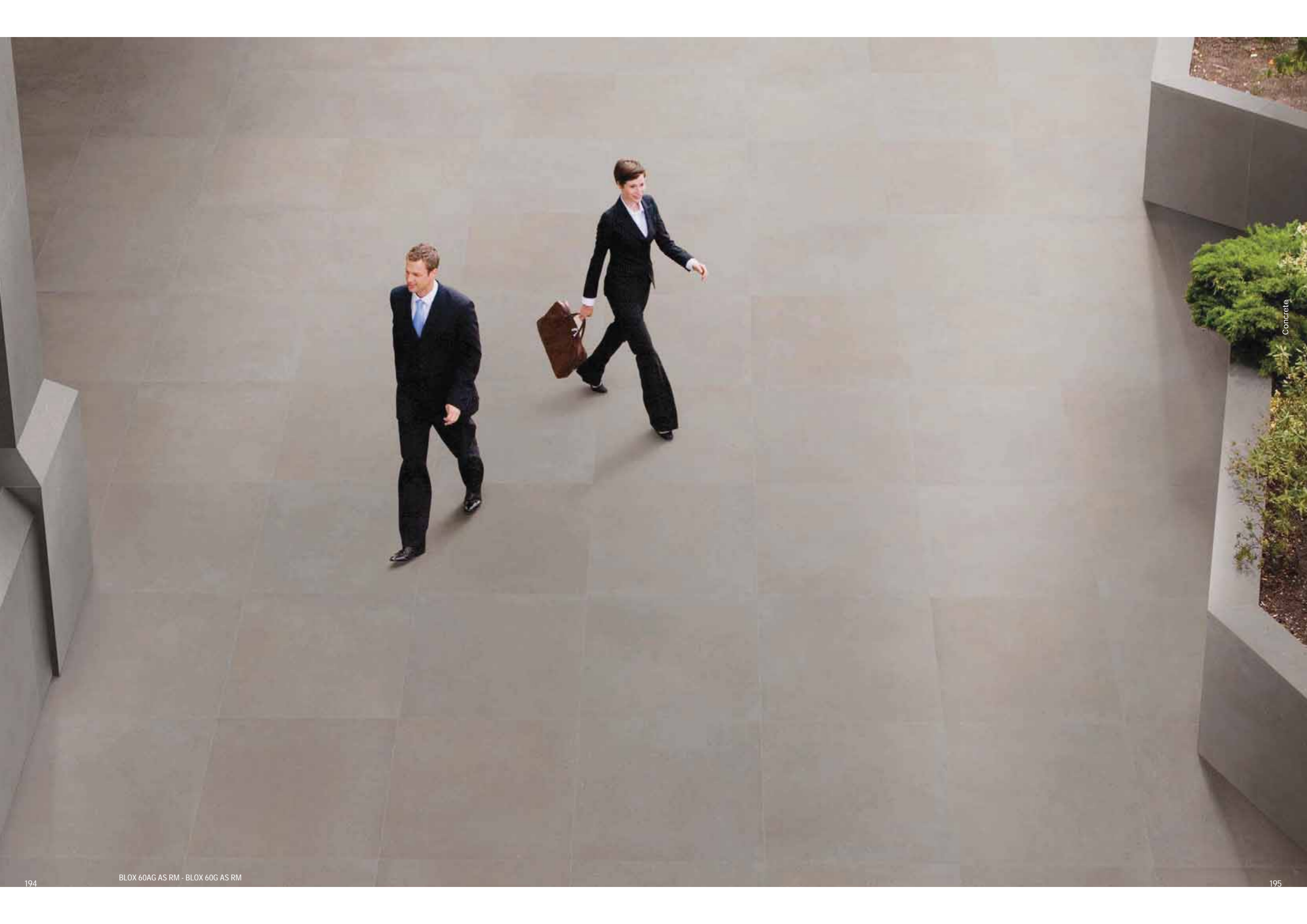

Concrete



Concrete

	10mm	20mm	
	 60X60-24°X24°	 90X90-36°X36°	 60X60-24°X24°
BS	BLOX R60BS RM	BLOX 90BS AS RM	BLOX 60BS AS RM
B	BLOX R60B RM	BLOX 90B AS RM	BLOX 60B AS RM
W	BLOX R60W RM		
AG	BLOX R60AG RM	BLOX 90AG AS RM	BLOX 60AG AS RM
G	BLOX R60G RM	BLOX 90G AS RM	BLOX 60G AS RM
DG	BLOX R60DG RM		

10 PEZZI SPECIALI
SPECIAL PIECES / PIÈCES SPÉCIALES / SONDERPREISE / PIEZAS ESPECIALES / СПЕЦИАЛЬНЫЕ ЭЛЕМЕНТЫ / 特制件

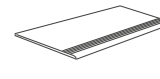
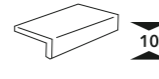
	 30X60-12°X24° △ 8	 20X60X4-8°X24°X2° △ 6
BS	BLOX S R60BS	BLOX E R60BS
B	BLOX S R60B	BLOX E R60B
W	BLOX S R60W	BLOX E R60W
AG	BLOX S R60AG	BLOX E R60AG
G	BLOX S R60G	BLOX E R60G
DG	BLOX S R60DG	BLOX E R60DG

IMBALLI
PACKAGING / EMBALLAGES / VERPACKUNGEN / EMBALAJES / УПАКОВКИ / 包装

FORMATO NOMINALE NOMINAL SIZE	BORDO EDGE	SPESSORE THICKNESS	BOX			PALLET		
			PZ/BOX PCS/BOX	MQ/BOX SM/BOX	KG/BOX KG/BOX	BOX/PALLET BOXES/PALLET	MQ/PALLET SM/PALLET	KG/PALLET KG/PALLET
60X60-24°X24°	RECTIFIED	10	3	1,08	24,32	40	43,20	992,86

CARATTERISTICHE TECNICHE SPECIFICHE
TECHNICAL FEATURES SPECIFICATIONS / CARACTÉRISTIQUES TECHNIQUES SPÉCIFIQUE / TECHNISCHE EIGENSCHAFTEN
CARACTERÍSTICAS TÉCNICAS ESPECÍFICAS / ТРЕБУЕМЫЕ ТЕХНИЧЕСКИЕ ХАРАКТЕРИСТИКИ / 特殊技术规格

	DIN 51130 (R)	DIN 51097 (A+B+C)	BCR REP. CEC 6/81		DM 14/6/89 N. 236		PENDULUM TEST BS (INGLESE)	PENDULUM TEST AS/NZS 4856:2004 (AUSTRALIANO)	PENDULUM TEST UNE ENV 12633:2003 (SPAGNOLO)	BOT 3000 (DCOF)
			G.A.	G.B.	C.A.	G.B.				
BLOX R	R11	B+C	>0.4	>0.4	>0.4	>0.4	>36	>45	3	>0,42
BLOX AS	R11	B+C	>0.4	>0.4	>0.4	>0.4	>36	>45	3	>0,42

20 PEZZI SPECIALI
SPECIAL PIECES / PIÈCES SPÉCIALES / SONDERPREISE / PIEZAS ESPECIALES / СПЕЦИАЛЬНЫЕ ЭЛЕМЕНТЫ / 特制件

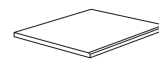
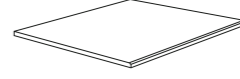
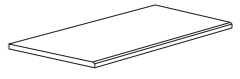
	 SQUARE BORDER* costa lucida SQUARE BORDER* polished edge 60X60-24°X24° △ 2	 SQUARE BORDER* costa lucida SQUARE BORDER* polished edge 90X90-36°X36° △ 1	 GRADONE* costa lucida TERRACE* polished edge 33X60-13°X24° △ 4
BS	BLOX SB60BS AS	BLOX SB90BS AS	BLOX GR336BS AS
B	BLOX SB60B AS	BLOX SB90B AS	BLOX GR336B AS
AG	BLOX SB60AG AS	BLOX SB90AG AS	BLOX GR336AG AS
G	BLOX SB60G AS	BLOX SB90G AS	BLOX GR336G AS

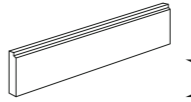
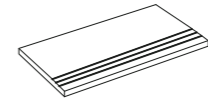
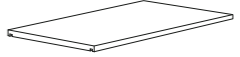
	 ALZATA gocciolatoio ALZATA gocciolatoio 20X60-8°X24° △ 4	 STEP righe costa lucida STEP stripes polished edge 30X60-12°X24° △ 4	 TOP gocciolatoio coste lucide TOP dripstone polished edges 30X60-12°X24° △ 4
BS	BLOX AZ60BS AS	BLOX S 60BS AS	BLOX TOP60BS AS
B	BLOX AZ60B AS	BLOX S 60B AS	BLOX TOP60B AS
AG	BLOX AZ60AG AS	BLOX S 60AG AS	BLOX TOP60AG AS
G	BLOX AZ60G AS	BLOX S 60G AS	BLOX TOP60G AS

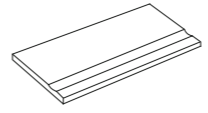
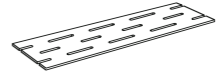
	 BORDO PISCINA* costa lucida POOL EDGE* polished edge 30X60-12°X24° △ 4	 GRIGLIA PISCINA* POOL GRILLE* 20X60-8°X24° △ 2
BS	BLOX BP60BS AS	BLOX GP60BS AS
B	BLOX BP60B AS	BLOX GP60B AS
AG	BLOX BP60AG AS	BLOX GP60AG AS
G	BLOX BP60G AS	BLOX GP60G AS

IMBALLI
PACKAGING / EMBALLAGES / VERPACKUNGEN / EMBALAJES / УПАКОВКИ / 包装

FORMATO NOMINALE NOMINAL SIZE	BORDO EDGE	SPESSORE THICKNESS	BOX			PALLET		
			PZ/BOX PCS/BOX	MQ/BOX SM/BOX	KG/BOX KG/BOX	BOX/PALLET BOXES/PALLET	MQ/PALLET SM/PALLET	KG/PALLET KG/PALLET
90X90-36°X36°	RECTIFIED	20	1	0,81	37,08	30	24,30	1132,38
60X60-24°X24°	RECTIFIED	20	2	0,72	33,15	32	23,04	1080,80

* Angolari DX e SX disponibili a richiesta. / RH and LH angle bracket available on request. / Angulaires D et G disponibles sur demande. / Eckstücke links und rechts auf Anfrage erhältlich. / Cantonerias DCHA. e IZDA. disponibles bajo pedido. / Правый и Левый Угловые элементы доступны по запросу. / 可根据需求提供左转角和右转角。

I pezzi speciali ed i fondi possono presentare leggere differenze di tonalità fra di loro. / Special pieces and backgrounds can have slightly different shades from one another. / Les pièces spéciales et les fonds peuvent présenter de légères différences de tonalités entre elles. / Formteile und Grundierungen können untereinander leichte Farbabweichungen aufweisen. / Las piezas especiales y los fondos pueden presentar ligeras diferencias de tono. Специальные и фоновые элементы могут немного отличаться по оттенку. / 一些特殊配件和底部可能会有轻微色差。

Il bordo può mostrare una piccola diversità cromatica fra la superficie ed il corpo del pezzo ceramico. / There can be a slight colour difference on the edge between the surface and the main ceramic piece. / Le bord peut présenter une légère différence entre la surface et le corps de la pièce en céramique. / Die Kante kann zwischen Oberfläche und Korpus des Keramiktells einen unterschiedlichen Farbton aufweisen. / El borde puede presentar ligeras diferencias cromáticas entre la superficie y el cuerpo de la pieza cerámica. / В кромках может появиться небольшая хроматическая разница между поверхностью и корпусом керамической детали. / 边缘的颜色可能与陶瓷产品主体和表面颜色稍有差别。