



CHARLOTTE

EQB DESIGN



TABELLA PREZZI FINITURE	pag. W-4
INFO TECNICHE	pag. W-4
INDICE / INDEX	pag. W-6
LAVABO	pag. W-10
BIDET	pag. W-11
DOCCIA INCASSO	pag. W-12
DEVIATORI INCASSO	pag. W-13
DOCCIA ESTERNO	pag. W-14
DOCCIA ESTERNO TERMOSTATICO	pag. W-15
VASCA	pag. W-16
BAGNO COMPLEMENTI	pag. W-17



CHARLOTTE

PREZZO FINITURE

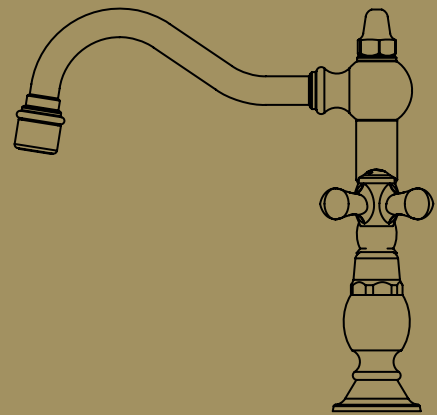
Calcola il prezzo di listino (IVA esclusa) delle finiture diverse dal cromato, consultando la seguente tabella.

Moltiplicare il **PREZZO LISTINO** per il **COEFFICIENTE MOLTIPLICATORE** della finitura scelta, arrotondando per difetto il prezzo ottenuto (eliminare i centesimi).
ESEMPIO per ordinare art. 0704/C in finitura dorato: codice **04-0704/C**

PRICE FINISHES

Include the list price (excluding VAT) of different finishes from chrome, consulting the following table. **Multiply the PRICE LIST MULTIPLIER COEFFICIENT** of the chosen finish, **reducing the price obtained by deleting the centesim.**

EXAMPLE to order art. 0704/C gold finish: code **04-0704/C**

COMPOSIZIONE CODICE PER ORDINARE ARTICOLO IN FINITURA

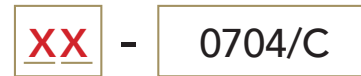

CODICE FINITURA
FINISH CODE

CODICE ARTICOLO
ITEM NUMBER

FINITURE DI SERIE / STANDARD FINISHES

CODICE CODE	DESCRIZIONE FINITURA FINISH DESCRIPTION	MOLTIPLICATORE MULTIPLIER
01-	cromato / chrome	PREZZO LISTINO*
02-	cromo/oro / chrome/gold	x
04-	dorato / gold	x
05-	bronzo satinato / satin bronze	x
06-	rame vecchio / old copper	x
07-	vecchio argento / old silver	x
08-	canna di fucile / gun barrel	x
12-	ottone lucido / polished brass	x
13-	ottone naturale / natural brass	x
14-	bianco / white	x
72-	bronzo opaco / mat bronze	x

FINITURE A RICHIESTA / ON REQUEST FINISHES

CODICE CODE	DESCRIZIONE FINITURA FINISH DESCRIPTION	MOLTIPLICATORE MULTIPLIER
30-	nickel lucido / polished nickel	x
33-	cromo satinato / satin chrome	x
34-	cromo spazzolato / brushing chrome	x
35-	nickel spazzolato / brushing nickel	x
56-	avorio / ivory	x
57-	azzurro / light blue	x
58-	verdino / light green	x
59-	marrone / brown	x
60-	arancio / orange	x
61-	rosso / red	x
66-	bianco opaco / mat white	x
67-	nero opaco / mat black	x
68-	rame opaco / mat copper	x
69-	argento opaco / mat silver	x
71-	oro opaco / mat gold	x
75-	dorato spazzolato / brushing gold	x
87-	oro rosa / pink gold	x
88-	ottone sisal / sisal brass	x

FINITURE A RICHIESTA / ON REQUEST FINISHES

CODICE CODE	DESCRIZIONE FINITURA FINISH DESCRIPTION	MOLTIPLICATORE MULTIPLIER
03-	oro/argento / gold/silver	x
10-	verderame / verdigris	x
11-	nero antracite / anthracite black	x
19-	nero / black	x
28-	nickel satinato / satin nickel	x

*PREZZO DI LISTINO / PRICE LIST

*NON REALIZZABILE / NOT MADE

ATTENZIONE! 13-OTTONE NATURALE e 88-OTTONE SISAL: finiture non protette che antichizzano naturalmente ossidando a contatto con l'umidità atmosferica.
WARNING! 13-NATURAL BRASS and 88-SISAL BRASS: unprotected finishes that naturally oxidise in contact with atmospheric humidity.

PROGETTO SU MISURA: RICHIESTE SPECIALI

I tecnici di Bellosta Rubinetterie sono, inoltre, a disposizione di architetti e designers, per offrire un servizio esclusivo: personalizzazioni di elementi in funzione di specifiche richieste estetiche o problematiche legate a vincoli progettuali, verifica della fattibilità attraverso opportuni studi CAD e sviluppo del disegno tecnico del prodotto speciale richiesto.

Per informazioni e richieste PROGETTI SU MISURA:
 ufficiotecnico@bellostarubinetterie.com



PROGETTO SU MISURA: SPECIAL REQUESTS

Engineers Bellosta Rubinetterie are also available to architects and designers, to offer an exclusive service: customizations of items according to specific aesthetic requirements or issues related to design constraints, verification of the feasibility studies and development through appropriate CAD technical design the required special product. For information and requests "SU MISURA" PROJECTS:
 ufficiotecnico@bellostarubinetterie.com

CONSIGLIO TECNICO

Tutti i miscelatori della collezione CHARLOTTE vengono collaudati nel loro funzionamento al momento dell'assemblaggio. Per garantire la durata delle cartucce nel tempo, si consiglia di spurgare bene l'impianto idraulico prima del montaggio (per rimuovere eventuali detriti) e di installare rubinetti sottolavabo con filtro:

art. 020 o 020/1 per i monofori, art. 020 e art. 029 (tubetti di collegamento con calotta) per i tre fori.

N.B.: Qualora il piano lavabo avesse uno spessore superiore a 2,5 cm specificare la misura al momento dell'ordine.

TECHNICAL ADVICE

All mixers of the CHARLOTTE collection are perfectly tested. To guarantee the perfect functionality of the cartridge for a long time, we advise to clean the sanitary plant before installing the mixer. Moreover we advise to install angle valve with filter:

art. 020 or 020/1 for single hole mixers, art. 020 and art. 029 (pipes with nut 1/2") for three holes mixers

Attention: If the lavatory top is more than cm 2,5 hick, please point it out when placing the order.



CHARLOTTE

FORATURA DEI PIANI SANITARI

I miscelatori lavabo/bidet monoforo prevedono un foro di diametro 35 mm nel piano sanitario. Le batterie lavabo 3 fori sono dotate di vitone ceramico destro con apertura a 1/4 di giro (90°); l'interasse consigliato è di 110 mm e foratura come da schema sottostante.

DRILLING PLANS HEALTH

The sink / hole bidet mixers provide a hole diameter of 35 mm in the health plan. The sink batteries 3 holes are equipped with ceramic cartridge Right-open 1/4 turn (90°); the recommended distance is 110 mm, drilling as per the diagram below.

MONOFORO >>

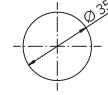

3 FORI >>

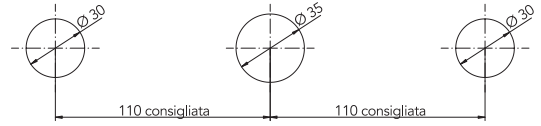

SCHEMA FUNZIONAMENTO DEVIATORI INCASSO 2/3/4 USCITE

Questi deviatori non hanno funzione di chiusura. Ruotando verso destra o sinistra si attivano le uscite. Tra 2 uscite adiacenti durante la rotazione diminuisce la portata dell'uscita iniziale ed incrementa quella della successiva. In posizione intermedia sono entrambe attive a pari portata.

SCHEME OPERATION SWITCHES FLUSH OUTPUT 2/3/4

These diverters have not closing function. By turning to the right or left activates the outputs. Between two adjacent outputs during the rotation decreases the initial output flow and increases that of the next. In position intermediate are both active at the same flow rate.



2 OUT

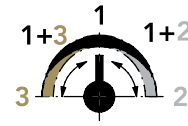

3 OUT

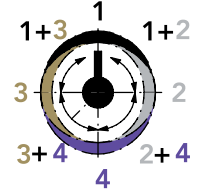

4 OUT

SCHEMA DI APERTURA MISCELATORE INCASSO CON MANIGLIA A CROCE
DIAGRAM FOR OPENING BUILT-IN MIXER WITH CROSS HANDLE

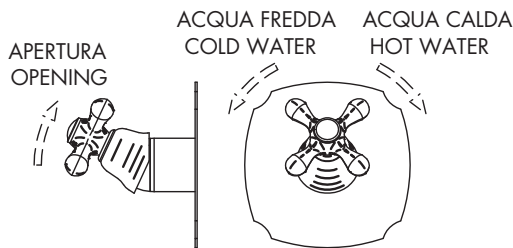

LAVABO

0705/7/C pag. W-10
 BATTERIA LAVABO TRE FORI
 3 HOLE BASIN



0705/4/C pag. W-10
 BATTERIA LAVABO TRE FORI BOCCA ALTA
 GIREVOLE
 3 HOLE BASIN HIGH SWINGING SPOUT



0704/C pag. W-10
 GRUPPO LAVABO DUE FORI
 1 HOLE BASIN GROUP HIGH SWINGING SPOUT



0705/C pag. W-10
 GRUPPO LAVABO DUE FORI
 1 HOLE BASIN GROUP HIGH SWINGING SPOUT



0705/1/C pag. W-10
 GRUPPO LAVABO MONOFORO BOCCA ALTA
 GIREVOLE
 1 HOLE BASIN GROUP HIGH SWINGING SPOUT



0702/C pag. W-11
 GRUPPO LAVABO MONOFORO BOCCA ALTA
 GIREVOLE
 1 HOLE BASIN GROUP HIGH SWINGING SPOUT



0705/5/C/E + 034075 pag. W-11
 GRUPPO LAVABO DA PARETE
 WALL BASIN GROUP



parti esterne / external parts: 0705/5/C/E
 parte incasso / built-in part: 034075

BIDET

0707/C pag. W-11
 BATTERIA BIDET TRE FORI EROGAZIONE DA
 BORDO
 3 HOLE BIDET WITH BOARD EROGATION



0707/7/C pag. W-11
 BATTERIA BIDET TRE FORI
 3 HOLE BIDET



0707/4/C pag. W-11
 BATTERIA BIDET TRE FORI BOCCA ALTA GIREVOLE
 3 HOLE BIDET HIGH SWINGING SPOUT



0707/2/C pag. W-12
 GRUPPO BIDET MONOFORO BOCCA ALTA
 GIREVOLE
 1 HOLE BIDET GROUP HIGH SWINGING SPOUT



0703/C pag. W-12
 GRUPPO BIDET MONOFORO BOCCA ALTA
 GIREVOLE
 1 HOLE BIDET GROUP HIGH SWINGING SPOUT



DOCCIA INCASSO

0700/3/C/E + 034133 pag. W-12
 GRUPPO INCASSO C/DEVIATORE 2 USCITE
 BUILT-IN GROUP WITH DIVERTER 2 OUT



parti esterne / external parts: 0700/3/C/E
 parte incasso / built-in part: 034133

0321/M/E + 104018 pag. W-12
 MISCELATORE INCASSO
 BUILT-IN MIXER



parti esterne / external parts: 0321/M/E
 parte incasso / built-in part: 104018

DOCCIA INCASSO



0321/M/K/E + 104018 pag.W-12

MISCELATORE INCASSO
BUILT-IN MIXER



parti esterne / external parts: 0321/M/K/E
parte incasso / built-in part: 104018



0300/M/E + 104002 pag.W-13

MISCELATORE INCASSO C/DEVIATORE 2 USCITE
BUILT-IN MIXER WITH DIVERTER 2 OUT



parti esterne / external parts: 0300/M/E
parte incasso / built-in part: 104002



0300/M/K/E + 104002 pag.W-13

MISCELATORE INCASSO C/DEVIATORE 2 USCITE
BUILT-IN MIXER WITH DIVERTER 2 OUT



parti esterne / external parts: 0300/M/K/E
parte incasso / built-in part: 104002

DEVIATORI INCASSO



0303/2/1/E + 914016 pag.W-13

DEVIATORE INCASSO 2 USCITE
BUILT-IN DIVERTER 2 OUT



parti esterne / external parts: 0303/2/1/E
parte incasso / built-in part: 914016



0303/2K/E + 914016 pag.W-13

DEVIATORE INCASSO 2 USCITE
BUILT-IN DIVERTER 2 OUT



parti esterne / external parts: 0303/2K/E
parte incasso / built-in part: 914016



0303/3/1/E + 034127 pag.W-13

DEVIATORE INCASSO 3 USCITE
BUILT-IN DIVERTER 3 OUT



parti esterne / external parts: 0303/3/1/E
parte incasso / built-in part: 034127



0303/3K/E + 034127 pag.W-14

DEVIATORE INCASSO 3 USCITE
BUILT-IN DIVERTER 3 OUT



parti esterne / external parts: 0303/3K/E
parte incasso / built-in part: 034127



0303/4/1/E + 034128 pag.W-14

DEVIATORE INCASSO 4 USCITE
BUILT-IN DIVERTER 4 OUT



parti esterne / external parts: 0303/4/1/E
parte incasso / built-in part: 034128



0303/4K/E + 034128 pag.W-14

DEVIATORE INCASSO 4 USCITE
BUILT-IN DIVERTER 4 OUT



parti esterne / external parts: 0303/4K/E
parte incasso / built-in part: 034128

DOCCIA INCASSO TERMOSTATICO



0312/K/E + 484020 pag. 259*

MISCELATORE TERMOSTATICO INCASSO 1 USCITA
BUILT-IN THERMOSTATIC MIXER 1 OUT



parti esterne / external parts: 0312/K/E
parte incasso / built-in part: 484020



0312/2/K/E + 484021 pag. 259*

MISCELATORE TERMOSTATICO INCASSO
C/DEVIATORE 2 USCITE
BUILT-IN THERMOSTATIC MIXER WITH DIVERTER
2 OUT



parti esterne / external parts: 0312/2/K/E
parte incasso / built-in part: 484021



0312/3/K/E + 484022 pag. 259*

MISCELATORE TERMOSTATICO INCASSO
C/DEVIATORE 3 USCITE
BUILT-IN THERMOSTATIC MIXER WITH DIVERTER
3 OUT



parti esterne / external parts: 0312/3/K/E
parte incasso / built-in part: 484022



0312/4/K/E + 484023 pag. 259*

MISCELATORE TERMOSTATICO INCASSO
C/DEVIATORE 4 USCITE
BUILT-IN THERMOSTATIC MIXER WITH DIVERTER
4 OUT



parti esterne / external parts: 0312/4/K/E
parte incasso / built-in part: 484023

DOCCIA ESTERNO



0709/1/C pag.W-14

GRUPPO DOCCIA ESTERNO
EXTERNAL SHOWER GROUP



0709/4/C pag.W-15

GRUPPO DOCCIA ESTERNO C/STELO
EXTERNAL SHOWER GROUP WITH PIPE

* ABBINAMENTO CONSIGLIATO: PER PREZZI E SCHEDE TECNICHE, VEDI RIFERIMENTO PAGINA LISTINO REVIVRE

* RECOMMENDED COMBINATION: FOR PRICES AND TECHNICAL DETAILS, LOOK AT PAGE WITH REFERENCE REVIVRE PRICE

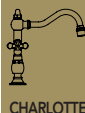

DOCCIA ESTERNO

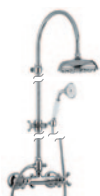

0709/5/1/C pag. **W-15**

GRUPPO DOCCIA ESTERNO C/STELO COMPLETO
EXTERNAL SHOWER GROUP WITH COMPLETE PIPE

DOCCIA ESTERNO TERMOSTATICO



0311/1A/C pag. **W-15**

MISCELATORE DOCCIA ESTERNO TERMOSTATICO
EXTERNAL THERMOSTATIC SHOWER MIXER



0311/4A/C pag. **W-15**

MISCELATORE DOCCIA ESTERNO TERMOSTATICO
C/STELO
EXTERNAL THERMOSTATIC SHOWER MIXER WITH
PIPE

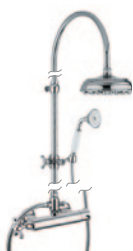

0711/5A/C pag. **W-15**

MISCELATORE DOCCIA ESTERNO TERMOSTATICO
C/STELO COMPLETO
EXTERNAL THERMOSTATIC SHOWER MIXER WITH
COMPLETE PIPE

DOCCIA COMPLEMENTI



0303/1/A pag. **132***

SUPPORTO DOCCIA COMPLETO
FULL SHOWER SUPPORT



0303/1K/A pag. **132***

SUPPORTO DOCCIA COMPLETO
FULL SHOWER SUPPORT



0303/1 pag. **132***

SUPPORTO DOCCIA DUPLEX COMPLETO
FULL SHOWER SUPPORT WITH DUPLEX



0730 pag. **140***

SALISCENDI COMPLETO C/PRESA D'ACQUA
COMPLETE WALL PIPE WITH WATER CONNECTION



1030/1 pag. **146***

ASTA SALISCENDI
WALL PIPE



0513/4 pag. **149***

STELO DOCCIA
ROD SHOWER



0713/5/1 pag. **151***

CURVA PRESA ACQUA C/STELO COMPLETO
CURVE WATER CONNECTOR WITH COMPLETE ROD

VASCA



0701/C pag. **W-16**

GRUPPO VASCA ESTERNO
EXTERNAL BATH GROUP



0701/4/C pag. **W-16**

GRUPPO VASCA C/RACCORDI PER BORDO VASCA
BATH GROUP WITH RIM CONNECTION

VASCA

0701/2/C pag. **W-16**
 BATTERIA PER BORDO VASCA
 BATH RIM



0701/20/C pag. **W-16**
 BATTERIA PER BORDO VASCA S/BOCCA
 BATH RIM WITHOUT SPOUT



0701/40/26/C pag. **W-16**
 GRUPPO VASCA C/RACCORDI A PAVIMENTO
 BATH GROUP WITH FLOOR CONNECTION

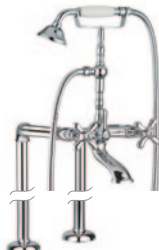

0303 pag. **W-17**
 BOCCA VASCA DA PARETE
 WALL BATH SPOUT



BAGNO COMPLEMENTI

0708/CC/E + 034034 pag. **W-17**
 RUBINETTO D'ARRESTO 1/2"
 BUILT-IN STOP COCK 1/2"



parti esterne / external parts: 0708/CC/E
 parte incasso / built-in part: 034034 DX



0708/CF/E + 034034 pag. **W-17**
 RUBINETTO D'ARRESTO 1/2"
 BUILT-IN STOP COCK 1/2"



parti esterne / external parts: 0708/CF/E
 parte incasso / built-in part: 034034 DX



0708/CC/E + 034036 pag. **W-17**
 RUBINETTO D'ARRESTO 3/4"
 BUILT-IN STOP COCK 3/4"



parti esterne / external parts: 0708/CC/E
 parte incasso / built-in part: 034036



0708/CF/E + 034036 pag. **W-17**
 RUBINETTO D'ARRESTO 3/4"
 BUILT-IN STOP COCK 3/4"



parti esterne / external parts: 0708/CF/E
 parte incasso / built-in part: 034036 DX



0340/E + 884053 pag. **W-18**
 PASSO RAPIDO 3/4"
 BUILT-IN RAPID FLOW COCK 3/4"



parti esterne / external parts: 0340/E
 parte incasso / built-in part: 884053



0340/K/E + 884053 pag. **W-18**
 PASSO RAPIDO 3/4"
 BUILT-IN RAPID FLOW COCK 3/4"



parti esterne / external parts: 0340/K/E
 parte incasso / built-in part: 884053



0340/E + 884054 pag. **W-18**
 PASSO RAPIDO 1"
 BUILT-IN RAPID FLOW COCK 1"



parti esterne / external parts: 0340/E
 parte incasso / built-in part: 884054



0340/K/E + 884054 pag. **W-18**
 PASSO RAPIDO 1"
 BUILT-IN RAPID FLOW COCK 1"



parti esterne / external parts: 0340/K/E
 parte incasso / built-in part: 884054



0332/2/E + 035212 pag. **W-18**
 SARACINESCA
 GATE VALVE



parti esterne / external parts: 0332/2/E
 parte incasso / built-in part: 035212



0332/2/K/E + 035212 pag. **W-19**
 SARACINESCA
 GATE VALVE



parti esterne / external parts: 0332/2/K/E
 parte incasso / built-in part: 035212



0705/7/C

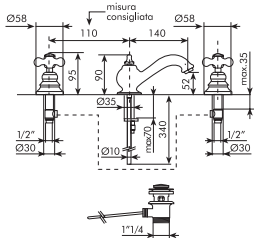

BATTERIA LAVABO TRE FORI

- > vitone ceramico 90°
- > interasse bocca 140
- > senza flessibili di alimentazione
- > con scarico
- > maniglia a croce

- 035046 p. 150
- 034005 p. 140

CROMATO	ALTRE FINITURE
01-0705/7/C €	XX-0705/7/C € x M*

0705/4/C

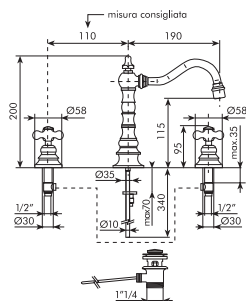

BATTERIA LAVABO TRE FORI BOCCA ALTA GIREVOLE

- > vitone ceramico 90°
- > interasse bocca 190
- > bocca girevole 360°
- > senza flessibili di alimentazione
- > con scarico
- > maniglia a croce

- 035046 p. 150
- 034013 p. 140

CROMATO	ALTRE FINITURE
01-0705/4/C €	XX-0705/4/C € x M*

0704/C

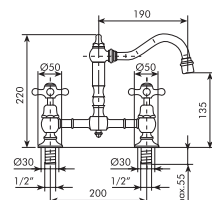

GRUPPO LAVABO DUE FORI

- > vitone ceramico 90°
- > interasse bocca 190
- > bocca girevole 360°
- > due fori attacchi da 1/2"
- > senza scarico
- > maniglia a croce

- 0136 - 0136/1 p. 717
- 035046 p. 150
- 034013 p. 140

CROMATO	ALTRE FINITURE
01-0704/C €	XX-0704/C € x M*

0705/C

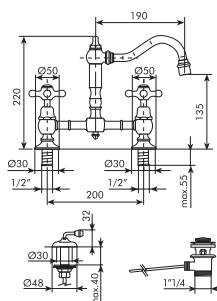

GRUPPO LAVABO DUE FORI

- > vitone ceramico 90°
- > interasse bocca 190
- > bocca girevole 360°
- > due fori attacchi da 1/2"
- > con scarico
- > maniglia a croce

- 035046 p. 150
- 034013 p. 140

CROMATO	ALTRE FINITURE
01-0705/C €	XX-0705/C € x M*

0705/1/C

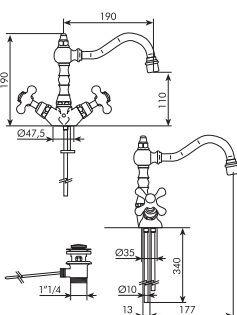

GRUPPO LAVABO MONOFORO BOCCA ALTA GIREVOLE

- > vitone ceramico 90°
- > interasse bocca 177
- > bocca girevole 360°
- > flessibili di alimentazione
- > con scarico
- > maniglia a croce

- 035046 p. 150
- 034013 p. 140

CROMATO	ALTRE FINITURE
01-0705/1/C €	XX-0705/1/C € x M*

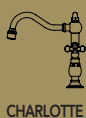

CHARLOTTE



0702/C

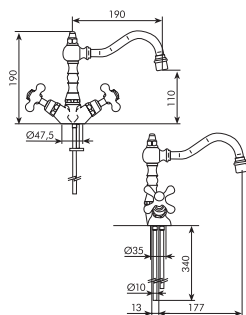

GRUPPO LAVABO MONOFORO BOCCA ALTA

GIREVOLE

- > vitone ceramico 90°
- > interasse bocca 177
- > bocca girevole 360°
- > flessibili di alimentazione
- > senza scarico
- > maniglia a croce



CROMATO

01-0702/C

€

ALTRE FINITURE

XX-0702/C

€

x M*

0705/5/C/E + 034075

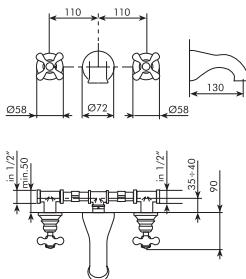

GRUPPO LAVABO DA PARETE

- > vitone ceramico 90°
- > interasse bocca 130
- > uscita libera senza aeratore
- > ingressi da 1/2"
- > senza scarico
- > maniglia a croce

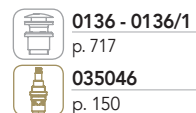

PARTI ESTERNE - CROMATO

01-0705/5/C/E

€

PARTI ESTERNE - ALTRE FINITURE

XX-0705/5/C/E

€

x M*

PARTE INCASSO

034075

info pag. 31

€

PREZZO TOTALE

€

0707/C

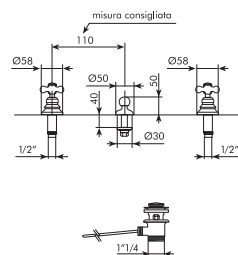

BATTERIA BIDET TRE FORI EROGAZIONE DA BORDO

- > vitone ceramico 90°
- > senza bocca
- > per ceramica con erogazione da bordo
- > senza flessibili di alimentazione
- > con scarico
- > maniglia a croce



CROMATO

01-0707/C

€

ALTRE FINITURE

XX-0707/C

€

x M*

0707/7/C

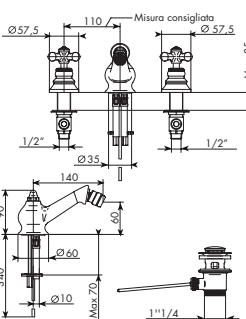

BATTERIA BIDET TRE FORI

- > vitone ceramico 90°
- > interasse bocca 140
- > aeratore snodato
- > senza flessibili di alimentazione
- > con scarico
- > maniglia a croce



CROMATO

01-0707/7/C

€

ALTRE FINITURE

XX-0707/7/C

€

x M*

0707/4/C

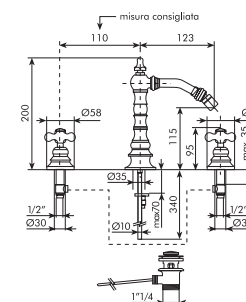

BATTERIA BIDET TRE FORI BOCCA ALTA GIREVOLE

- > vitone ceramico 90°
- > interasse bocca 123
- > aeratore snodato
- > senza flessibili di alimentazione
- > con scarico
- > maniglia a croce



CROMATO

01-0707/4/C

€

ALTRE FINITURE

XX-0707/4/C

€

x M*

ACCESSORI



SCARICO C/TAPPO A PRESSIONE

RICAMBI IMMEDIATI



VITONE CERAMICO



AERATORE TONDO

XX = CODICE FINITURA RICHIESTA: per identificare codice corretto vedi pag. W-4
 M* = MOLTIPLICATORE: per calcolare il prezzo delle altre finiture vedi tabella pag. W-4

0707/2/C

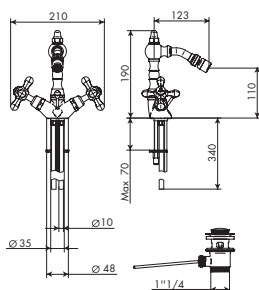

GRUPPO BIDET MONOFORO BOCCA ALTA GIREVOLE

- > vitone ceramico 90°
- > interasse bocca 123
- > aeratore snodato
- > flessibili di alimentazione
- > con scarico
- > maniglia a croce

	035046	p. 150
	074001	p. 140

CROMATO		ALTRE FINITURE	
01-0707/2/C	€	XX-0707/2/C	€ x M*

0703/C

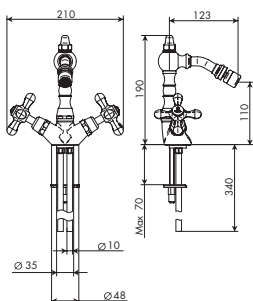

GRUPPO BIDET MONOFORO BOCCA ALTA GIREVOLE

- > vitone ceramico 90°
- > interasse bocca 123
- > aeratore snodato
- > flessibili di alimentazione
- > senza scarico
- > maniglia a croce

	0136 - 0136/1	p. 717
	035046	p. 150
	074001	p. 140

CROMATO		ALTRE FINITURE	
01-0703/C	€	XX-0703/C	€ x M*

0700/3/C/E + 034133

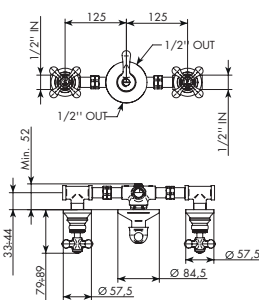

GRUPPO INCASSO C/DEVIATORE 2 USCITE

- > vitone ceramico 90°
- > deviatore a dischi ceramici 2 uscite senza chiusura
- > attacchi da 1/2"
- > maniglia a croce

	035046	p. 150
	635010	p. 131

PARTI ESTERNE - CROMATO		PARTI ESTERNE - ALTRE FINITURE	
01-0700/3/C/E	€	XX-0700/3/C/E	€ x M*
PARTE INCASSO			
034133	info pag. 34	€	
PREZZO TOTALE		€	

0321/M/E + 104018

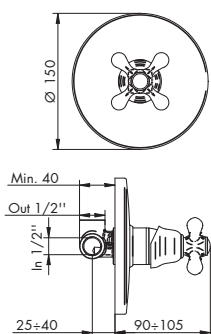

MISCELATORE INCASSO

- > cartuccia tradizionale
- > attacchi da 1/2"
- > uscita superiore
- > incasso con B-Box
- > maniglia a croce
- > piastra tonda spessorata

	025002	p. 149
--	--------	--------

PARTI ESTERNE - CROMATO		PARTI ESTERNE - ALTRE FINITURE	
01-0321/M/E	€	XX-0321/M/E	€ x M*
PARTE INCASSO			
01-104018	info pag. 36	€	
PREZZO TOTALE		€	

0321/M/K/E + 104018

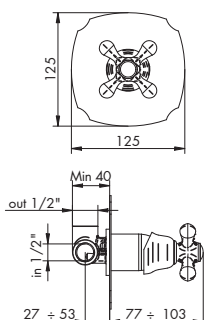
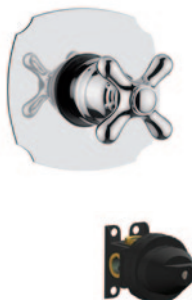

MISCELATORE INCASSO

- > cartuccia tradizionale
- > attacchi da 1/2"
- > uscita superiore
- > incasso con B-Box
- > maniglia a croce
- > piastra classic

	025002	p. 149
--	--------	--------

PARTI ESTERNE - CROMATO		PARTI ESTERNE - ALTRE FINITURE	
01-0321/M/K/E	€	XX-0321/M/K/E	€ x M*
PARTE INCASSO			
01-104018	info pag. 36	€	
PREZZO TOTALE		€	

0300/M/E + 104002

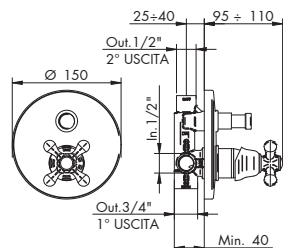

MISCELATORE INCASSO C/DEVIATORE 2 USCITE

- > cartuccia tradizionale
- > deviatore a pressione 2 uscite c/ritorno automatico e blocco meccanico basse pressioni
- > attacchi da 1/2"
- > uscita principale inferiore da 3/4"
- > maniglia a croce
- > piastra tonda spessorata

025002
p. 149105029
p. 131

PARTI ESTERNE - CROMATO

01-0300/M/E €

PARTI ESTERNE - ALTRE FINITURE

XX-0300/M/E € x M*

PARTE INCASSO

01-104002 info pag. 37 €

PREZZO TOTALE €

0300/M/K/E + 104002

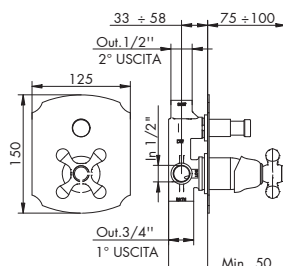

MISCELATORE INCASSO C/DEVIATORE 2 USCITE

- > cartuccia tradizionale
- > deviatore a pressione 2 uscite c/ritorno automatico e blocco meccanico basse pressioni
- > attacchi da 1/2"
- > uscita principale inferiore da 3/4"
- > incasso con B-Box
- > maniglia a croce
- > piastra classic

025002
p. 149105029
p. 131

PARTI ESTERNE - CROMATO

01-0300/M/K/E €

PARTI ESTERNE - ALTRE FINITURE

XX-0300/M/K/E € x M*

PARTE INCASSO

01-104002 info pag. 37 €

PREZZO TOTALE €

0303/2/1/E + 914016

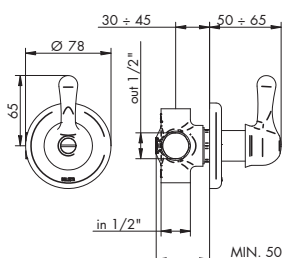

DEVIATORE INCASSO 2 USCITE

- > deviatore a dischi ceramici 2 uscite senza chiusura
- > attacchi da 1/2"

635010
p. 131035346 fino 9.2017
p. 131

PARTI ESTERNE - CROMATO

01-0303/2/1/E €

PARTI ESTERNE - ALTRE FINITURE

XX-0303/2/1/E € x M*

PARTE INCASSO

914016 info pag. 38 €

PREZZO TOTALE €

0303/2K/E + 914016

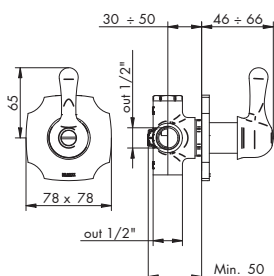
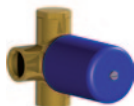

DEVIATORE INCASSO 2 USCITE

- > deviatore a dischi ceramici 2 uscite senza chiusura
- > attacchi da 1/2"
- > piastra classic

635010
p. 131035346 fino 9.2017
p. 131

PARTI ESTERNE - CROMATO

01-0303/2K/E €

PARTI ESTERNE - ALTRE FINITURE

XX-0303/2K/E € x M*

PARTE INCASSO

914016 info pag. 38 €

PREZZO TOTALE €

0303/3/1/E + 034127

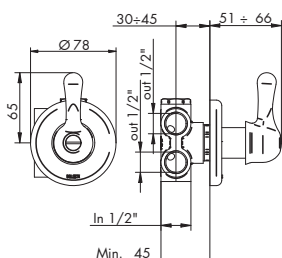

DEVIATORE INCASSO 3 USCITE

- > deviatore a dischi ceramici 3 uscite senza chiusura
- > attacchi da 1/2"

635011
p. 131035345 fino 9.2017
p. 131

PARTI ESTERNE - CROMATO

01-0303/3/1/E €

PARTI ESTERNE - ALTRE FINITURE

XX-0303/3/1/E € x M*

PARTE INCASSO

034127 info pag. 38 €

PREZZO TOTALE €

RICAMBI IMMEDIATI



CARTUCCIA

CARTUCCIA
DEVIATRICE

DEVIATORE

XX = CODICE FINITURA RICHIESTA: per identificare codice corretto vedi pag. W-4
M* = MOLTIPLICATORE: per calcolare il prezzo delle altre finiture vedi tabella pag. W-4

0303/3K/E + 034127

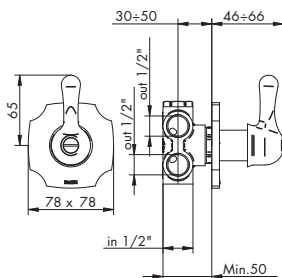

DEVIATORE INCASSO 3 USCITE

- > deviatore a dischi ceramici 3 uscite senza chiusura
- > attacchi da 1/2"
- > piastra classic

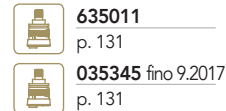

635011

p. 131

035345 fino 9.2017

p. 131

PARTI ESTERNE - CROMATO

01-0303/3K/E €

PARTE INCASSO

034127 info pag. 38 €

PREZZO TOTALE €

PARTI ESTERNE - ALTRE FINITURE

XX-0303/3K/E € x M*

0303/4/1/E + 034128

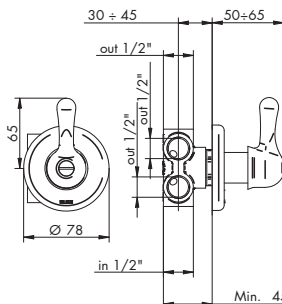

DEVIATORE INCASSO 4 USCITE

- > deviatore a dischi ceramici 4 uscite senza chiusura
- > attacchi da 1/2"

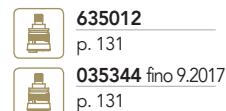

635012

p. 131

035344 fino 9.2017

p. 131

PARTI ESTERNE - CROMATO

01-0303/4/1/E €

PARTE INCASSO

034128 info pag. 38 €

PREZZO TOTALE €

PARTI ESTERNE - ALTRE FINITURE

XX-0303/4/1/E € x M*

0303/4K/E + 034128

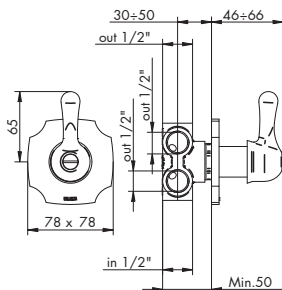

DEVIATORE INCASSO 4 USCITE

- > deviatore a dischi ceramici 4 uscite senza chiusura
- > attacchi da 1/2"
- > piastra classic

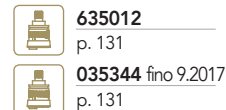

635012

p. 131

035344 fino 9.2017

p. 131

PARTI ESTERNE - CROMATO

01-0303/4K/E €

PARTE INCASSO

034128 info pag. 38 €

PREZZO TOTALE €

PARTI ESTERNE - ALTRE FINITURE

XX-0303/4K/E € x M*

I DOCCIA INCASSO TERMOSTATICO CONSIGLIATI SONO PRESENTI SU LISTINO REVIVRE

- 0312/K/E + 484020
- 0312/2/K/E + 484021
- 0312/3/K/E + 484022
- 0312/4/K/E + 484023

I DOCCIA COMPLEMENTI CONSIGLIATI SONO PRESENTI SU LISTINO REVIVRE

- 0303/1/A 1030/1
- 0303/1K/A 0513/4
- 0303/1 0713/5/1
- 0730

0709/1/C

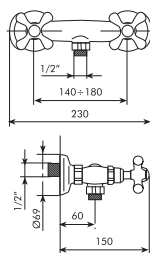

GRUPPO DOCCIA ESTERNO

- > vitone ceramico 90°
- > senza set doccia
- > attacchi da 1/2"
- > maniglia a croce

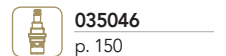

035046

p. 150

CROMATO

01-0709/1/C €

ALTRE FINITURE

XX-0709/1/C € x M*

0709/4/C

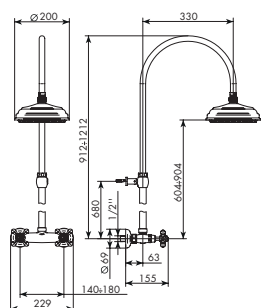

GRUPPO DOCCIA ESTERNO C/STELO

- > vitone ceramico 90°
- > stelo regolabile
- > soffione orientabile Ø200 in ottone senza anticalcare
- > attacchi da 1/2"
- > maniglia a croce



CROMATO

01-0709/4/C

€

ALTRE FINITURE

XX-0709/4/C

€

x M*

0709/5/1/C

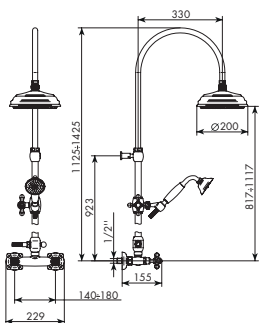

GRUPPO DOCCIA ESTERNO C/STELO COMPLETO

- > vitone ceramico 90°
- > stelo regolabile
- > deviatore a trazione c/ritorno automatico e blocco meccanico bassa pressione
- > soffione Ø200 in ottone senza anticalcare
- > flessibile in ottone 150 cm
- > supporto doccetta scorrevole
- > attacchi da 1/2" > maniglia a croce
- > doccetta monogetto in metallo senza anticalcare manico in porcellana Ø77



CROMATO

01-0709/5/1/C

€

ALTRE FINITURE

XX-0709/5/1/C

€

x M*

0311/1A/C

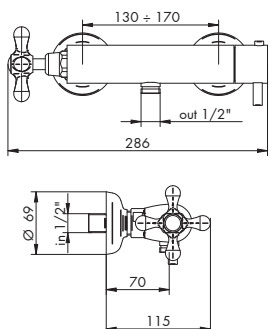

MISCELATORE DOCCIA ESTERNO TERMOSTATICO

- > cartuccia termostatica
- > vitone ceramico 90°
- > senza set doccia
- > attacchi da 1/2"
- > maniglia a croce



CROMATO

01-0311/1A/C

€

ALTRE FINITURE

XX-0311/1A/C

€

x M*

0311/4A/C

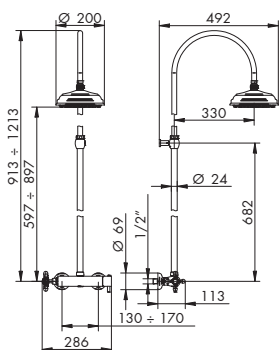

MISCELATORE DOCCIA ESTERNO TERMOSTATICO C/STELO

- > cartuccia termostatica
- > stelo regolabile
- > soffione orientabile Ø200 in ottone senza anticalcare
- > attacchi da 1/2"
- > maniglia a croce



CROMATO

01-0311/4A/C

€

ALTRE FINITURE

XX-0311/4A/C

€

x M*

0711/5A/C

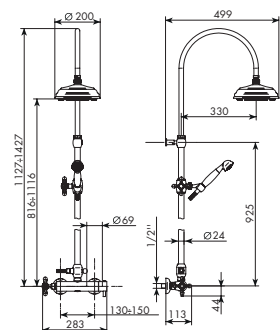

MISCELATORE DOCCIA ESTERNO TERMOSTATICO C/STELO COMPLETO

- > cartuccia termostatica
- > stelo regolabile
- > deviatore a trazione c/ritorno automatico e blocco meccanico bassa pressione
- > soffione Ø200 in ottone senza anticalcare
- > flessibile in ottone 150 cm > supporto doccetta scorrevole
- > attacchi da 1/2" > maniglia a croce
- > doccetta monogetto in metallo senza anticalcare manico in porcellana Ø77

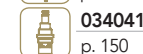

CROMATO

01-0711/5A/C

€

ALTRE FINITURE

XX-0711/5A/C

€

x M*

RICAMBI IMMEDIATI



XX = CODICE FINITURA RICHIESTA: per identificare codice corretto vedi pag. W-4
M* = MOLTIPLICATORE: per calcolare il prezzo delle altre finiture vedi tabella pag. W-4

0303

BOCCA VASCA DA PARETE

- > interasse bocca 130
- > uscita libera senza aeratore
- > attacco da 3/4"

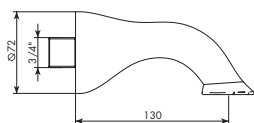

CROMATO	
01-0303	€

ALTRE FINITURE	
XX-0303	€ x M*

0708/CC/E + 034034

RUBINETTO D'ARRESTO 1/2"

- > vitone ceramico 90°
- > Placchetta con scritta "C"
- > ingressi da 1/2"

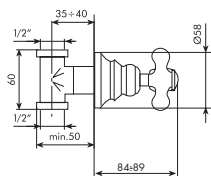

PARTI ESTERNE - CROMATO	
01-0708/CC/E	€

PARTI ESTERNE - ALTRE FINITURE	
XX-0708/CC/E	€ x M*

PARTE INCASSO	
034034	info pag. 39 €

PREZZO TOTALE	
	€

0708/CF/E + 034034

RUBINETTO D'ARRESTO 1/2"

- > vitone ceramico 90°
- > placchetta con scritta "F"
- > ingressi da 1/2"

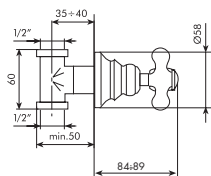

PARTI ESTERNE - CROMATO	
01-0708/CF/E	€

PARTI ESTERNE - ALTRE FINITURE	
XX-0708/CF/E	€ x M*

PARTE INCASSO	
034034	info pag. 39 €

PREZZO TOTALE	
	€

0708/CC/E + 034036

RUBINETTO D'ARRESTO 3/4"

- > vitone ceramico 90°
- > placchetta con scritta "C"
- > ingressi da 3/4"

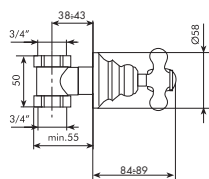

PARTI ESTERNE - CROMATO	
01-0708/CC/E	€

PARTI ESTERNE - ALTRE FINITURE	
XX-0708/CC/E	€ x M*

PARTE INCASSO	
034036	info pag. 39 €

PREZZO TOTALE	
	€

0708/CF/E + 034036

RUBINETTO D'ARRESTO 3/4"

- > vitone ceramico 90°
- > placchetta con scritta "F"
- > ingressi da 3/4"

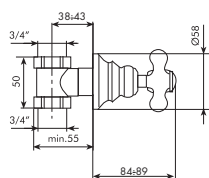

PARTI ESTERNE - CROMATO	
01-0708/CF/E	€

PARTI ESTERNE - ALTRE FINITURE	
XX-0708/CF/E	€ x M*

PARTE INCASSO	
034036	info pag. 39 €

PREZZO TOTALE	
	€

RICAMBI IMMEDIATI



XX = CODICE FINITURA RICHIESTA: per identificare codice corretto vedi pag. W-4
 M* = MOLTIPLICATORE: per calcolare il prezzo delle altre finiture vedi tabella pag. W-4

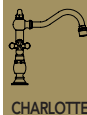

0340/E + 884053

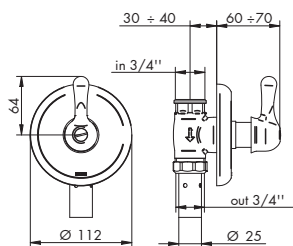

PASSO RAPIDO 3/4"

- > vitone tradizionale
- > abbinare a saracinesca
- > ingressi da 3/4"



PARTI ESTERNE - CROMATO	
01-0340/E	€
PARTE INCASSO	
884053	info pag. 42 €
PREZZO TOTALE	€

PARTI ESTERNE - ALTRE FINITURE	
XX-0340/E	€ x M*

0340/K/E + 884053

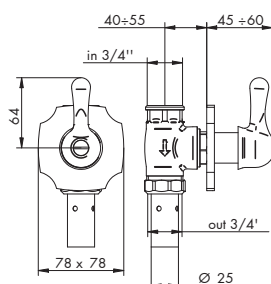

PASSO RAPIDO 3/4"

- > vitone tradizionale
- > abbinare a saracinesca
- > ingressi da 3/4"
- > piastra classic



PARTI ESTERNE - CROMATO	
01-0340/K/E	€
PARTE INCASSO	
884053	info pag. 42 €
PREZZO TOTALE	€

PARTI ESTERNE - ALTRE FINITURE	
XX-0340/K/E	€ x M*

0340/E + 884054

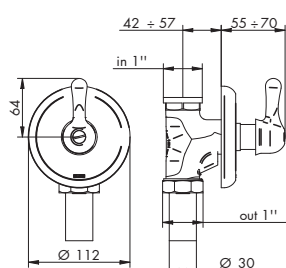

PASSO RAPIDO 1"

- > vitone tradizionale
- > abbinare a saracinesca
- > ingressi da 1"



PARTI ESTERNE - CROMATO	
01-0340/E	€
PARTE INCASSO	
884054	info pag. 42 €
PREZZO TOTALE	€

PARTI ESTERNE - ALTRE FINITURE	
XX-0340/E	€ x M*

0340/K/E + 884054

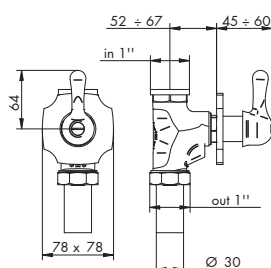

PASSO RAPIDO 1"

- > vitone tradizionale
- > abbinare a saracinesca
- > ingressi da 1"
- > piastra classic



PARTI ESTERNE - CROMATO	
01-0340/K/E	€
PARTE INCASSO	
884054	info pag. 42 €
PREZZO TOTALE	€

PARTI ESTERNE - ALTRE FINITURE	
XX-0340/K/E	€ x M*

0332/2/E + 035212

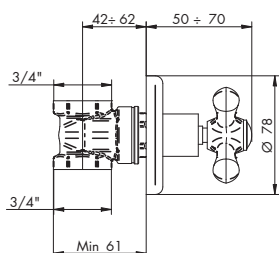

SARACINESCA

- > attacchi da 3/4"
- > maniglia a croce

PARTI ESTERNE - CROMATO	
01-0332/2/E	€
PARTE INCASSO	
035212	info pag. 42 €
PREZZO TOTALE	€

PARTI ESTERNE - ALTRE FINITURE	
XX-0332/2/E	€ x M*

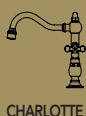

CHARLOTTE

0332/2/K/E + 035212

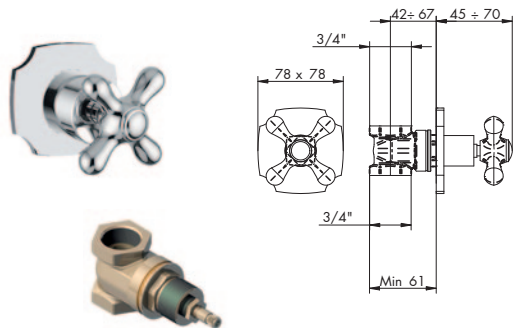

SARACINESCA

- > attacchi da 3/4"
- > piastra classic
- > maniglia a croce

PARTI ESTERNE - CROMATO

01-0332/2/K/E €

PARTE INCASSO

035212 info pag. 42 €

PREZZO TOTALE €

PARTI ESTERNE - ALTRE FINITURE

XX-0332/2/K/E € x M*

