



# REVIVRE COMANDI DEDICATI

EQB DESIGN



TABELLA PREZZI FINITURE	pag. 240
INFO TECNICHE	pag. 242
INDICE / INDEX	pag. 243
BABY S	pag. 248
BELLINI	pag. 248
EDWARD	pag. 250
ELITE	pag. 251
FUNTANIN BIJOUX	pag. 252
F-VOGUE BIJOUX	pag. 252
IXS	pag. 253
JEANS	pag. 255
JOCONDE	pag. 256
LIFE LEVER	pag. 257
LUDO	pag. 258
ROMINA   CHARLOTTE	pag. 259
STRESA   STRESA SUITE	pag. 260



**PREZZO FINITURE**

Calcola il prezzo di listino (IVA esclusa) delle finiture diverse dal cromato, consultando la seguente tabella.

Moltiplicare il **PREZZO LISTINO** per il **COEFFICIENTE MOLTIPLICATORE** della finitura scelta, arrotondando per difetto il prezzo ottenuto (eliminare i centesimi).  
**ESEMPIO** per ordinare art. 4812/P/E in finitura dorato: codice **04-4812/P/E**

**COMPOSIZIONE CODICE PER ORDINARE ARTICOLO IN FINITURA**

**XX** - **4812/P/E**

**CODICE FINITURA**      **CODICE ARTICOLO**  
**FINISH CODE**            **ITEM NUMBER**

**PRICE FINISHES**

Include the list price (excluding VAT) of different finishes from chrome, consulting the following table. Multiply the **PRICE LIST MULTIPLIER COEFFICIENT** of the chosen finish, reducing the price obtained by deleting the centesim.

**EXAMPLE** to order art. 4812/P/E gold finish: code **04-4812/P/E**

**FINITURE REALIZZABILI**

CODICE CODE	DESCRIZIONE FINITURA FINISH DESCRIPTION	BABY S	BELLINI	EDWARD	ELITE	FUNTANIN BIJOUX	F-VOGUE BIJOUX	IXS
01-	cromato / chrome	PREZZO LISTINO°	PREZZO LISTINO°	PREZZO LISTINO°	PREZZO LISTINO°	PREZZO LISTINO°	PREZZO LISTINO°	N.R.
02-	cromo/oro / chrome/gold	x	x	x	x	x	x	N.R.
03-	oro/argento / gold/silver	x	x	x	x	x	x	N.R.
04-	dorato / gold	x	x	x	x	x	x	N.R.
05-	bronzo satinato / satin bronze	x	x	x	x	x	x	N.R.
06-	rame vecchio / old copper	x	x	x	x	x	N.R.	N.R.
07-	vecchio argento / old silver	x	x	x	x	N.R.	N.R.	N.R.
08-	canna di fucile / gun barrel	x	N.R.	x	x	N.R.	x	N.R.
10-	verderame / verdigris	N.R.	N.R.	x	N.R.	N.R.	N.R.	N.R.
11-	nero antracite / anthracite black	N.R.	N.R.	x	N.R.	N.R.	x	N.R.
12-	ottone lucido / polished brass	x	x	x	N.R.	N.R.	x	N.R.
13-	ottone naturale / natural brass	x	x	x	N.R.	x	x	N.R.
14-	bianco / white	x	N.R.	x	x	N.R.	N.R.	N.R.
19-	nero / black	x	N.R.	x	x	N.R.	N.R.	N.R.
28-	nickel satinato / satin nickel	x	x	x	x	x	x	N.R.
30-	nickel lucido / polished nickel	x	x	x	x	N.R.	x	N.R.
33-	cromo satinato / satin chrome	x	x	x	x	x	x	N.R.
34-	cromo spazzolato / brushing chrome	x	x	x	x	x	x	N.R.
35-	nickel spazzolato / brushing nickel	x	x	x	x	x	x	N.R.
56-	avorio / ivory	N.R.	N.R.	x	N.R.	N.R.	N.R.	N.R.
57-	azzurro / light blue	N.R.	N.R.	x	N.R.	N.R.	N.R.	N.R.
58-	verdino / light green	N.R.	N.R.	x	N.R.	N.R.	N.R.	N.R.
59-	marrone / brown	N.R.	N.R.	x	N.R.	N.R.	N.R.	N.R.
60-	arancio / orange	N.R.	N.R.	x	N.R.	N.R.	N.R.	N.R.
61-	rosso / red	N.R.	N.R.	x	N.R.	N.R.	N.R.	N.R.
66-	bianco opaco / mat white	x	x	x	x	x	x	N.R.
67-	nero opaco / mat black	x	x	x	x	x	x	N.R.
68-	rame opaco / mat copper	x	x	x	x	x	x	N.R.
69-	argento opaco / mat silver	x	x	x	x	x	x	N.R.
71-	oro opaco / mat gold	x	x	x	x	N.R.	x	N.R.
72-	bronzo opaco / mat bronze	x	x	x	x	N.R.	x	N.R.
75-	dorato spazzolato / brushing gold	x	x	x	x	N.R.	x	N.R.
77-	inox 316 spazzolato	N.R.	N.R.	N.R.	N.R.	N.R.	N.R.	PREZZO LISTINO°
87-	oro rosa / pink gold	x	x	x	x	x	x	N.R.
88-	ottone sisal / sisal brass	x	x	x	N.R.	x	x	N.R.



**PROGETTO SU MISURA: RICHIESTE SPECIALI**

I tecnici di Bellosta Rubinetterie sono, inoltre, a disposizione di architetti e designers, per offrire un servizio esclusivo: personalizzazioni di elementi in funzione di specifiche richieste estetiche o problematiche legate a vincoli progettuali, verifica della fattibilità attraverso opportuni studi CAD e sviluppo del disegno tecnico del prodotto speciale richiesto.

Per informazioni e richieste PROGETTI SU MISURA:  
ufficiotecnico@bellostarubinetterie.com



**progetto**  
sumisura

**PROGETTO SU MISURA: SPECIAL REQUESTS**

Engineers Bellosta Rubinetterie are also available to architects and designers, to offer an exclusive service: customizations of items according to specific aesthetic requirements or issues related to design constraints, verification of the feasibility studies and development through appropriate CAD technical design the required special product. For information and requests "SU MISURA" PROJECTS:  
ufficiotecnico@bellostarubinetterie.com

**FINITURE REALIZZABILI**

CODICE CODE	DESCRIZIONE FINITURA FINISH DESCRIPTION	JEANS	JOCONDE	LIFE LEVER	LUDO	ROMINA CHARLOTTE	STRESA STRESA SUITE
		PREZZO LISTINO°	PREZZO LISTINO°	PREZZO LISTINO°	PREZZO LISTINO°	PREZZO LISTINO°	PREZZO LISTINO°
01-	cromato / chrome						
02-	cromo/oro / chrome/gold	x	x	x	x	x	x
03-	oro/argento / gold/silver	x	x	x	x	x	x
04-	dorato / gold	x	x	x	x	x	x
05-	bronzo satinato / satin bronze	x	x	x	x	x	x
06-	rame vecchio / old copper	x	x	x	x	x	x
07-	vecchio argento / old silver	x	x	x	x	x	x
08-	canna di fucile / gun barrel	x	x	x	x	x	x
10-	verderame / verdigris	x	x	x	N.R.	x	x
11-	nero antracite / anthracite black	x	x	x	x	x	x
12-	ottone lucido / polished brass	x	x	x	x	x	x
13-	ottone naturale / natural brass	x	x	x	x	x	x
14-	bianco / white	x	x	x	N.R.	x	x
19-	nero / black	x	x	x	N.R.	x	x
28-	nickel satinato / satin nickel	x	x	x	x	x	x
30-	nickel lucido / polished nickel	x	x	x	x	x	x
33-	cromo satinato / satin chrome	x	x	x	x	x	x
34-	cromo spazzolato / brushing chrome	x	x	x	x	x	x
35-	nickel spazzolato / brushing nickel	x	x	x	x	x	x
56-	avorio / ivory	x	x	x	N.R.	x	x
57-	azzurro / light blue	x	x	x	N.R.	x	x
58-	verdino / light green	x	x	x	N.R.	x	x
59-	marrone / brown	x	x	x	N.R.	x	x
60-	arancio / orange	x	x	x	N.R.	x	x
61-	rosso / red	x	x	x	N.R.	x	x
66-	bianco opaco / mat white	x	x	x	x	x	x
67-	nero opaco / mat black	x	x	x	x	x	x
68-	rame opaco / mat copper	x	x	x	x	x	x
69-	argento opaco / mat silver	x	x	x	x	x	x
71-	oro opaco / mat gold	x	x	x	x	x	x
72-	bronzo opaco / mat bronze	x	x	x	x	x	x
75-	dorato spazzolato / brushing gold	x	x	x	x	x	x
77-	inox 316 spazzolato	N.R.	N.R.	N.R.	N.R.	N.R.	N.R.
87-	oro rosa / pink gold	x	x	x	x	x	x
88-	ottone sisal / sisal brass	x	x	x	x	x	x

**ATTENZIONE! 13-OTTONE NATURALE e 88-OTTONE SISAL: finiture non protette che antichizzano naturalmente ossidando a contatto con l'umidità atmosferica.**  
**WARNING! 13-NATURAL BRASS and 88-SISAL BRASS: unprotected finishes that naturally oxidise in contact with atmospheric humidity.**



**SCHEMA FUNZIONAMENTO MISCELATORI TERMOSTATICI 2/3/4 USCITE**

Leva in posizione ore 12 = deviatore chiuso. Ruotando verso destra o sinistra si attivano le diverse uscite. Partendo dalla posizione di STOP, durante la rotazione la portata dell'acqua si incrementa verso la posizione successiva. Tra 2 uscite adiacenti durante la rotazione diminuisce la portata dell'uscita iniziale ed incrementa quella della successiva. In posizione intermedia sono entrambe attive a pari portata.

**SCHEME OPERATING THERMOSTATIC MIXER 2/3/4 OUT**

Lever to the 12 o'clock position = switch closed. Turning left or right. They activate different outputs. Starting from the STOP position, while rotation of the water flow rate between two adjacent outputs is increased towards the next position. Between two adjacent outputs during the rotation decreases the initial output flow and increases that of the next. In position intermediate are both active at the same flow rate.

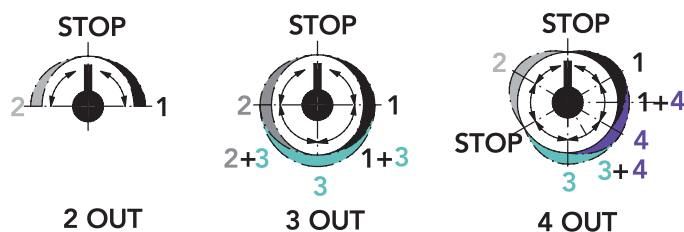

**LEVE**

Le leve della collezione BELLINI sono disponibili, **senza variazione di prezzo**, in:

**LEVERS**

Levers of BELLINI collection are available **without price change** in:

	finitura <b>-XX</b>	bianco opaco <b>-66</b>	nero opaco <b>-67</b>
<b>STILO</b> STILO			

La serie JOCONDE viene fornita sia con porcellana decorata che con porcellana bianca.

JOCONDE serie can be provided either with white or decorated porcelain.



**BABY S**



**7212/P/E + 484020** pag. 248

MISCELATORE TERMOSTATICO INCASSO 1 USCITA  
BUILT-IN THERMOSTATIC MIXER 1 OUT

parti esterne / external parts: 7212/P/E  
parte incasso / built-in part: 484020



**7212/2/P/E + 484021** pag. 248

MISCELATORE TERMOSTATICO INCASSO C/DEV 2 USCITE  
BUILT-IN THERMOSTATIC WITH DIVERTER 2 OUT

parti esterne / external parts: 7212/2/P/E  
parte incasso / built-in part: 484021



**7212/3/P/E + 484022** pag. 248

MISCELATORE TERMOSTATICO INCASSO C/DEV 3 USCITE  
BUILT-IN THERMOSTATIC WITH DIVERTER 3 OUT

parti esterne / external parts: 7212/3/P/E  
parte incasso / built-in part: 484022



**7212/4/P/E + 484023** pag. 248

MISCELATORE TERMOSTATICO INCASSO C/DEV 4 USCITE  
BUILT-IN THERMOSTATIC WITH DIVERTER 4 OUT

parti esterne / external parts: 7212/4/P/E  
parte incasso / built-in part: 484023

**BELLINI**



**6312/PE + 484020** pag. 248

MISCELATORE TERMOSTATICO INCASSO 1 USCITA  
BUILT-IN THERMOSTATIC MIXER 1 OUT

parti esterne / external parts: 6312/PE  
parte incasso / built-in part: 484020



**6312/PME + 484020** pag. 249

MISCELATORE TERMOSTATICO INCASSO 1 USCITA  
BUILT-IN THERMOSTATIC MIXER 1 OUT

parti esterne / external parts: 6312/PME  
parte incasso / built-in part: 484020



**6312/2/PE + 484021** pag. 249

MISCELATORE TERMOSTATICO INCASSO 2 USCITE  
BUILT-IN THERMOSTATIC MIXER WITH DIVERTER 2 OUT

parti esterne / external parts: 6312/2/PE  
parte incasso / built-in part: 484021



**6312/2/PME + 484021** pag. 249

MISCELATORE TERMOSTATICO INCASSO 2 USCITE  
BUILT-IN THERMOSTATIC MIXER WITH DIVERTER 2 OUT

parti esterne / external parts: 6312/2/PME  
parte incasso / built-in part: 484021



**6312/3/PE + 484022** pag. 249

MISCELATORE TERMOSTATICO INCASSO 3 USCITE  
BUILT-IN THERMOSTATIC MIXER WITH DIVERTER 3 OUT

parti esterne / external parts: 6312/3/PE  
parte incasso / built-in part: 484022



**6312/3/PME + 484022** pag. 249

MISCELATORE TERMOSTATICO INCASSO 3 USCITE  
BUILT-IN THERMOSTATIC MIXER WITH DIVERTER 3 OUT

parti esterne / external parts: 6312/3/PME  
parte incasso / built-in part: 484022



**6312/4/PE + 484023** pag. 250

MISCELATORE TERMOSTATICO INCASSO 4 USCITE  
BUILT-IN THERMOSTATIC MIXER WITH DIVERTER 4 OUT

parti esterne / external parts: 6312/4/PE  
parte incasso / built-in part: 484023



**6312/4/PME + 484023** pag. 250

MISCELATORE TERMOSTATICO INCASSO 4 USCITE  
BUILT-IN THERMOSTATIC MIXER WITH DIVERTER 4 OUT

parti esterne / external parts: 6312/4/PME  
parte incasso / built-in part: 484023

**EDWARD**



**0812/K/E + 484020** pag. 250

MISCELATORE TERMOSTATICO INCASSO 1 USCITA  
BUILT-IN THERMOSTATIC MIXER 1 OUT

parti esterne / external parts: 0812/K/E  
parte incasso / built-in part: 484020



**0812/2/K/E + 484021** pag. 250

MISCELATORE TERMOSTATICO INCASSO C/DEV 2 USCITE  
BUILT-IN THERMOSTATIC MIXER WITH DIVERTER 2 OUT

parti esterne / external parts: 0812/2/K/E  
parte incasso / built-in part: 484021



**0812/3/K/E + 484022** pag. 250

MISCELATORE TERMOSTATICO INCASSO C/DEV 3 USCITE  
BUILT-IN THERMOSTATIC MIXER WITH DIVERTER 3 OUT

parti esterne / external parts: 0812/3/K/E  
parte incasso / built-in part: 484022



**0812/4/K/E + 484023** pag. 251

MISCELATORE TERMOSTATICO INCASSO C/DEV 4 USCITE  
BUILT-IN THERMOSTATIC MIXER WITH DIVERTER 4 OUT

parti esterne / external parts: 0812/4/K/E  
parte incasso / built-in part: 484023



ELITE



9112/P/E + 484020 pag. 251

MISCELATORE TERMOSTATICO INCASSO 1 USCITA  
BUILT-IN THERMOSTATIC MIXER 1 OU

parti esterne / external parts: 9112/P/E  
parte incasso / built-in part: 484020



9112/2/P/E + 484021 pag. 251

MISCELATORE TERMOSTATICO INCASSO  
C/DEVIATORE 2 USCITE  
BUILT-IN THERMOSTATIC MIXER WITH DIVERTER  
2 OUT

parti esterne / external parts: 9112/2/P/E  
parte incasso / built-in part: 484021



9112/3/P/E + 484022 pag. 251

MISCELATORE TERMOSTATICO INCASSO  
C/DEVIATORE 3 USCITE  
BUILT-IN THERMOSTATIC MIXER WITH DIVERTER  
3 OUT

parti esterne / external parts: 9112/3/P/E  
parte incasso / built-in part: 484022



9112/4/P/E + 484023 pag. 251

MISCELATORE TERMOSTATICO INCASSO  
C/DEVIATORE 4 USCITE  
BUILT-IN THERMOSTATIC MIXER WITH DIVERTER  
4 OUT

parti esterne / external parts: 9112/4/P/E  
parte incasso / built-in part: 484023

FUNTANIN BIJOUX



8312/P/E + 484020 pag. 252

MISCELATORE TERMOSTATICO INCASSO 1 USCITA  
C/SWAROVSKI  
BUILT-IN THERMOSTATIC MIXER 1 OUT WITH  
SWAROVSKI

parti esterne / external parts: 8312/P/E  
parte incasso / built-in part: 484020



8312/2/P/E + 484021 pag. 252

MISCELATORE TERMOSTATICO INCASSO  
C/DEVIATORE 2 USCITE C/SWAROVSKI  
BUILT-IN THERMOSTATIC MIXER WITH DIVERTER  
2 OUT AND SWAROVSKI

parti esterne / external parts: 8312/2/P/E  
parte incasso / built-in part: 484021



8312/3/P/E + 484022 pag. 252

MISCELATORE TERMOSTATICO INCASSO  
C/DEVIATORE 3 USCITE C/SWAROVSKI  
BUILT-IN THERMOSTATIC MIXER WITH DIVERTER  
3 OUT AND SWAROVSKI

parti esterne / external parts: 8312/3/P/E  
parte incasso / built-in part: 484022



8312/4/P/E + 484023 pag. 252

MISCELATORE TERMOSTATICO INCASSO  
C/DEVIATORE 4 USCITE C/SWAROVSKI  
BUILT-IN THERMOSTATIC MIXER WITH DIVERTER  
4 OUT AND SWAROVSKI

parti esterne / external parts: 8312/4/P/E  
parte incasso / built-in part: 484023

F-VOGUE BIJOUX



3312/P/E + 484020 pag. 252

MISCELATORE TERMOSTATICO INCASSO 1 USCITA  
C/SWAROVSKI  
BUILT-IN THERMOSTATIC MIXER 1 OUT WITH  
SWAROVSKI

parti esterne / external parts: 3312/P/E  
parte incasso / built-in part: 484020



3312/2/P/E + 484021 pag. 253

MISCELATORE TERMOSTATICO INCASSO C/  
DEVIATORE 2 USCITE C/SWAROVSKI  
BUILT-IN THERMOSTATIC MIXER WITH DIVERTER 2  
OUT AND SWAROVSKI

parti esterne / external parts: 3312/2/P/E  
parte incasso / built-in part: 484021



3312/3/P/E + 484022 pag. 253

MISCELATORE TERMOSTATICO INCASSO C/  
DEVIATORE 3 USCITE C/SWAROVSKI  
BUILT-IN THERMOSTATIC MIXER WITH DIVERTER 3  
OUT AND SWAROVSKI

parti esterne / external parts: 3312/3/P/E  
parte incasso / built-in part: 484022



3312/4/P/E + 484023 pag. 253

MISCELATORE TERMOSTATICO INCASSO C/  
DEVIATORE 4 USCITE C/SWAROVSKI  
BUILT-IN THERMOSTATIC MIXER WITH DIVERTER 4  
OUT AND SWAROVSKI

parti esterne / external parts: 3312/4/P/E  
parte incasso / built-in part: 484023

IXS | INOX AISI 316 L

NEW



4512/P/E + 484020 pag. 253

MISCELATORE TERMOSTATICO INCASSO 1 USCITA  
BUILT-IN THERMOSTATIC MIXER 1 OUT

parti esterne / external parts: 4512/P/E  
parte incasso / built-in part: 484020

NEW



4512/PQ/E + 484020 pag. 253

MISCELATORE TERMOSTATICO INCASSO 1 USCITA  
BUILT-IN THERMOSTATIC MIXER 1 OUT

parti esterne / external parts: 4512/PQ/E  
parte incasso / built-in part: 484020

NEW



4512/2/P/E + 484021 pag. 254

MISCELATORE TERMOSTATICO INCASSO  
C/DEVIATORE 2 USCITE  
BUILT-IN THERMOSTATIC MIXER WITH DIVERTER  
2 OUT

parti esterne / external parts: 4512/2/P/E  
parte incasso / built-in part: 484021

NEW



4512/2/PQ/E + 484021 pag. 254

MISCELATORE TERMOSTATICO INCASSO  
C/DEVIATORE 2 USCITE  
BUILT-IN THERMOSTATIC MIXER WITH DIVERTER  
2 OUT

parti esterne / external parts: 4512/2/PQ/E  
parte incasso / built-in part: 484021



**IXS | INOX AISI 316L**

**NEW** **4512/3/P/E + 484022** pag. 254

MISCELATORE TERMOSTATICO INCASSO  
C/DEVIATORE 3 USCITE  
BUILT-IN THERMOSTATIC MIXER WITH DIVERTER  
3 OUT

parti esterne / external parts: 4512/3/P/E  
parte incasso / built-in part: 484022



**NEW** **4512/3/PQ/E + 484022** pag. 254

MISCELATORE TERMOSTATICO INCASSO  
C/DEVIATORE 3 USCITE  
BUILT-IN THERMOSTATIC MIXER WITH DIVERTER  
3 OUT

parti esterne / external parts: 4512/3/PQ/E  
parte incasso / built-in part: 484022



**NEW** **4512/4/P/E + 484023** pag. 254

MISCELATORE TERMOSTATICO INCASSO  
C/DEVIATORE 4 USCITE  
BUILT-IN THERMOSTATIC MIXER WITH DIVERTER  
4 OUT

parti esterne / external parts: 4512/4/P/E  
parte incasso / built-in part: 484023



**NEW** **4512/4/PQ/E + 484023** pag. 255

MISCELATORE TERMOSTATICO INCASSO  
C/DEVIATORE 4 USCITE  
BUILT-IN THERMOSTATIC MIXER WITH DIVERTER  
4 OUT

parti esterne / external parts: 4512/4/PQ/E  
parte incasso / built-in part: 484023



**JEANS**

**4812/P/E + 484020** pag. 255

MISCELATORE TERMOSTATICO INCASSO 1 USCITA  
BUILT-IN THERMOSTATIC MIXER 1 OUT

parti esterne / external parts: 4812/P/E  
parte incasso / built-in part: 484020



**4812/PQ/E + 484020** pag. 255

MISCELATORE TERMOSTATICO INCASSO 1 USCITA  
BUILT-IN THERMOSTATIC MIXER 1 OUT

parti esterne / external parts: 4812/PQ/E  
parte incasso / built-in part: 484020



**4812/2/P/E + 484021** pag. 255

MISCELATORE TERMOSTATICO INCASSO  
C/DEVIATORE 2 USCITE  
BUILT-IN THERMOSTATIC MIXER WITH DIVERTER  
2 OUT

parti esterne / external parts: 4812/2/P/E  
parte incasso / built-in part: 484021



**4812/2/PQ/E + 484021** pag. 255

MISCELATORE TERMOSTATICO INCASSO  
C/DEVIATORE 2 USCITE  
BUILT-IN THERMOSTATIC MIXER WITH DIVERTER  
2 OUT

parti esterne / external parts: 4812/2/PQ/E  
parte incasso / built-in part: 484021



**4812/3/P/E + 484022** pag. 256

MISCELATORE TERMOSTATICO INCASSO  
C/DEVIATORE 3 USCITE  
BUILT-IN THERMOSTATIC MIXER WITH DIVERTER 3  
OUT

parti esterne / external parts: 4812/3/P/E  
parte incasso / built-in part: 484022



**4812/3/PQ/E + 484022** pag. 256

MISCELATORE TERMOSTATICO INCASSO  
C/DEVIATORE 3 USCITE  
BUILT-IN THERMOSTATIC MIXER WITH DIVERTER 3  
OUT

parti esterne / external parts: 4812/3/PQ/E  
parte incasso / built-in part: 484022



**4812/4/P/E + 484023** pag. 256

MISCELATORE TERMOSTATICO INCASSO  
C/DEVIATORE 4 USCITE  
BUILT-IN THERMOSTATIC MIXER WITH DIVERTER  
4 OUT

parti esterne / external parts: 4812/4/P/E  
parte incasso / built-in part: 484023



**4812/4/PQ/E + 484023** pag. 256

MISCELATORE TERMOSTATICO INCASSO  
C/DEVIATORE 4 USCITE  
BUILT-IN THERMOSTATIC MIXER WITH DIVERTER  
4 OUT

parti esterne / external parts: 4812/4/PQ/E  
parte incasso / built-in part: 484023



**JOCONDE**

**4012/K/E + 484020** pag. 256

MISCELATORE TERMOSTATICO INCASSO 1 USCITA  
BUILT-IN THERMOSTATIC MIXER 1 OUT

parti esterne / external parts: 4012/K/E  
parte incasso / built-in part: 484020



**4012/2/K/E + 484021** pag. 257

MISCELATORE TERMOSTATICO INCASSO  
C/DEVIATORE 2 USCITE  
BUILT-IN THERMOSTATIC MIXER WITH DIVERTER  
2 OUT

parti esterne / external parts: 4012/2/K/E  
parte incasso / built-in part: 484021



**4012/3/K/E + 484022** pag. 257

MISCELATORE TERMOSTATICO INCASSO  
C/DEVIATORE 3 USCITE  
BUILT-IN THERMOSTATIC MIXER WITH DIVERTER  
3 OUT

parti esterne / external parts: 4012/3/K/E  
parte incasso / built-in part: 484022



**4012/4/K/E + 484023** pag. 257

MISCELATORE TERMOSTATICO INCASSO  
C/DEVIATORE 4 USCITE  
BUILT-IN THERMOSTATIC MIXER WITH DIVERTER  
4 OUT

parti esterne / external parts: 4012/4/K/E  
parte incasso / built-in part: 484023





**LIFE LEVER**



**0512/H/PL/E + 484020** pag. 257

MISCELATORE TERMOSTATICO INCASSO 1 USCITA  
BUILT-IN THERMOSTATIC MIXER 1 OUT

parti esterne / external parts: 0512/H/PL/E  
parte incasso / built-in part: 484020



**0512/2/PL/E + 484021** pag. 257

MISCELATORE TERMOSTATICO INCASSO  
C/DEVIATORE 2 USCITE  
BUILT-IN THERMOSTATIC MIXER WITH DIVERTER  
2 OUT

parti esterne / external parts: 0512/2/PL/E  
parte incasso / built-in part: 484021



**0512/3/PL/E + 484022** pag. 258

MISCELATORE TERMOSTATICO INCASSO  
C/DEVIATORE 3 USCITE  
BUILT-IN THERMOSTATIC MIXER WITH DIVERTER  
3 OUT

parti esterne / external parts: 0512/3/PL/E  
parte incasso / built-in part: 484022



**0512/4/PL/E + 484023** pag. 258

MISCELATORE TERMOSTATICO INCASSO  
C/DEVIATORE 4 USCITE  
BUILT-IN THERMOSTATIC MIXER WITH DIVERTER  
4 OUT

parti esterne / external parts: 0512/4/PL/E  
parte incasso / built-in part: 484023

**LUDO**



**7312/P/E + 484020** pag. 258

MISCELATORE TERMOSTATICO INCASSO 1 USCITA  
BUILT-IN THERMOSTATIC MIXER 1 OUT

parti esterne / external parts: 7312/P/E  
parte incasso / built-in part: 484020



**7312/2/P/E + 484021** pag. 258

MISCELATORE TERMOSTATICO INCASSO  
C/DEVIATORE 2 USCITE  
BUILT-IN THERMOSTATIC MIXER WITH DIVERTER  
2 OUT

parti esterne / external parts: 7312/2/P/E  
parte incasso / built-in part: 484021



**7312/3/P/E + 484022** pag. 258

MISCELATORE TERMOSTATICO INCASSO  
C/DEVIATORE 3 USCITE  
BUILT-IN THERMOSTATIC MIXER WITH DIVERTER  
3 OUT

parti esterne / external parts: 7312/3/P/E  
parte incasso / built-in part: 484022



**7312/4/P/E + 484023** pag. 259

MISCELATORE TERMOSTATICO INCASSO  
C/DEVIATORE 4 USCITE  
BUILT-IN THERMOSTATIC MIXER WITH DIVERTER  
4 OUT

parti esterne / external parts: 7312/4/P/E  
parte incasso / built-in part: 484023

**ROMINA | CHARLOTTE**



**0312/K/E + 484020** pag. 259

MISCELATORE TERMOSTATICO INCASSO 1 USCITA  
BUILT-IN THERMOSTATIC MIXER 1 OUT

parti esterne / external parts: 0312/K/E  
parte incasso / built-in part: 484020



**0312/2/K/E + 484021** pag. 259

MISCELATORE TERMOSTATICO INCASSO C/DEV 2  
USCITE  
BUILT-IN THERMOSTATIC MIXER WITH DIVERTER 2  
OUT

parti esterne / external parts: 0312/2/K/E  
parte incasso / built-in part: 484021



**0312/3/K/E + 484022** pag. 259

MISCELATORE TERMOSTATICO INCASSO C/DEV 3  
USCITE  
BUILT-IN THERMOSTATIC MIXER WITH DIVERTER 3  
OUT

parti esterne / external parts: 0312/3/K/E  
parte incasso / built-in part: 484022



**0312/4/K/E + 484023** pag. 259

MISCELATORE TERMOSTATICO INCASSO C/DEV 4  
USCITE  
BUILT-IN THERMOSTATIC MIXER WITH DIVERTER 4  
OUT

parti esterne / external parts: 0312/4/K/E  
parte incasso / built-in part: 484023

**STRESA | STRESA SUITE**



**1412/K/E + 484020** pag. 260

MISCELATORE TERMOSTATICO INCASSO 1 USCITA  
BUILT-IN THERMOSTATIC MIXER 1 OUT

parti esterne / external parts: 1412/K/E  
parte incasso / built-in part: 484020



**1612/K/E + 484020 | SUITE** pag. 260

MISCELATORE TERMOSTATICO INCASSO 1 USCITA  
C/SWAROVSKI  
BUILT-IN THERMOSTATIC MIXER 1 OUT WITH  
SWAROVSKI

parti esterne / external parts: 1612/K/E  
parte incasso / built-in part: 484020



**1712/K/E + 484020** pag. 260

MISCELATORE TERMOSTATICO INCASSO 1 USCITA  
BUILT-IN THERMOSTATIC MIXER 1 OUT

parti esterne / external parts: 1712/K/E  
parte incasso / built-in part: 484020



**1812/K/E + 484020 | SUITE** pag. 260

MISCELATORE TERMOSTATICO INCASSO 1 USCITA  
C/SWAROVSKI  
BUILT-IN THERMOSTATIC MIXER 1 OUT WITH  
SWAROVSKI

parti esterne / external parts: 1812/K/E  
parte incasso / built-in part: 484020



STRESA | STRESA SUITE

**1412/2K/E + 484021** pag. 260



MISCELATORE TERMOSTATICO INCASSO  
C/DEVIATORE 2 USCITE  
BUILT-IN THERMOSTATIC MIXER WITH DIVERTER  
2 OUT

parti esterne / external parts: 1412/2K/E  
parte incasso / built-in part: 484021

**1612/2K/E + 484021 | SUITE** pag. 261



MISCELATORE TERMOSTATICO INCASSO  
C/DEVIATORE 2 USCITE C/SWAROVSKI  
BUILT-IN THERMOSTATIC MIXER WITH DIVERTER  
2 OUT AND SWAROVSKI

parti esterne / external parts: 1612/2K/E  
parte incasso / built-in part: 484021

**1712/2K/E + 484021** pag. 261



MISCELATORE TERMOSTATICO INCASSO  
C/DEVIATORE 2 USCITE  
BUILT-IN THERMOSTATIC MIXER WITH DIVERTER  
2 OUT

parti esterne / external parts: 1712/2K/E  
parte incasso / built-in part: 484021

**1812/2K/E + 484021 | SUITE** pag. 261



MISCELATORE TERMOSTATICO INCASSO  
C/DEVIATORE 2 USCITE C/SWAROVSKI  
BUILT-IN THERMOSTATIC MIXER WITH DIVERTER  
2 OUT AND SWAROVSKI

parti esterne / external parts: 1812/2K/E  
parte incasso / built-in part: 484021

**1412/3K/E + 484022** pag. 261



MISCELATORE TERMOSTATICO INCASSO  
C/DEVIATORE 3 USCITE  
BUILT-IN THERMOSTATIC MIXER WITH DIVERTER  
3 OUT

parti esterne / external parts: 1412/3K/E  
parte incasso / built-in part: 484022

**1612/3K/E + 484022 | SUITE** pag. 261



MISCELATORE TERMOSTATICO INCASSO  
C/DEVIATORE 3 USCITE C/SWAROVSKI  
BUILT-IN THERMOSTATIC MIXER WITH DIVERTER  
3 OUT AND SWAROVSKI

parti esterne / external parts: 1612/3K/E  
parte incasso / built-in part: 484022

**1712/3K/E + 484022** pag. 262



MISCELATORE TERMOSTATICO INCASSO  
C/DEVIATORE 3 USCITE  
BUILT-IN THERMOSTATIC MIXER WITH DIVERTER  
3 OUT

parti esterne / external parts: 1712/3K/E  
parte incasso / built-in part: 484022

**1812/3K/E + 484022 | SUITE** pag. 262



MISCELATORE TERMOSTATICO INCASSO  
C/DEVIATORE 3 USCITE C/SWAROVSKI  
BUILT-IN THERMOSTATIC MIXER WITH DIVERTER  
3 OUT AND SWAROVSKI

parti esterne / external parts: 1812/3K/E  
parte incasso / built-in part: 484022

**1412/4K/E + 484023** pag. 262



MISCELATORE TERMOSTATICO INCASSO  
C/DEVIATORE 4 USCITE  
BUILT-IN THERMOSTATIC MIXER WITH DIVERTER  
4 OUT

parti esterne / external parts: 1412/4K/E  
parte incasso / built-in part: 484023

**1612/4K/E + 484023 | SUITE** pag. 262



MISCELATORE TERMOSTATICO INCASSO  
C/DEVIATORE 4 USCITE C/SWAROVSKI  
BUILT-IN THERMOSTATIC MIXER WITH DIVERTER  
4 OUT AND SWAROVSKI

parti esterne / external parts: 1612/4K/E  
parte incasso / built-in part: 484023

**1712/4K/E + 484023** pag. 262



MISCELATORE TERMOSTATICO INCASSO  
C/DEVIATORE 4 USCITE  
BUILT-IN THERMOSTATIC MIXER WITH DIVERTER  
4 OUT

parti esterne / external parts: 1712/4K/E  
parte incasso / built-in part: 484023

**1812/4K/E + 484023 | SUITE** pag. 263



MISCELATORE TERMOSTATICO INCASSO  
C/DEVIATORE 4 USCITE C/SWAROVSKI  
BUILT-IN THERMOSTATIC MIXER WITH DIVERTER  
4 OUT AND SWAROVSKI

parti esterne / external parts: 1812/4K/E  
parte incasso / built-in part: 484023



7212/P/E + 484020

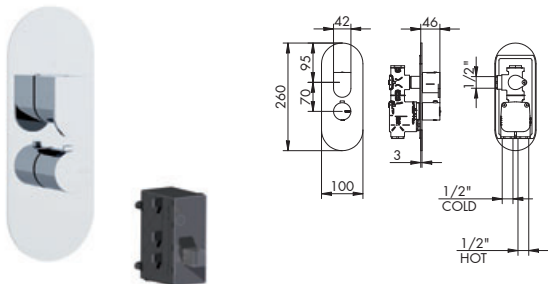

MISCELATORE TERMOSTATICO INCASSO 1 USCITA

- > cartuccia termostatica
- > vitone ceramico 90°
- > apertura con rotazione antioraria
- > ingressi inferiori da 1/2"
- > incasso con B-Box
- > posizionabile orizzontalmente
- > 2 maniglie
- > interasse 70 mm
- > uscite laterali destra da 1/2"
- > incasso regolabile min 76
- > piastra unica

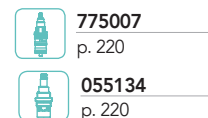

PARTI ESTERNE - CROMATO		PARTI ESTERNE - ALTRE FINITURE	
01-7212/P/E	€	XX-7212/P/E	€ x M*
<b>PARTE INCASSO</b>			
484020	info pag. 181 €		
<b>PREZZO TOTALE</b>		€	

7212/2/P/E + 484021

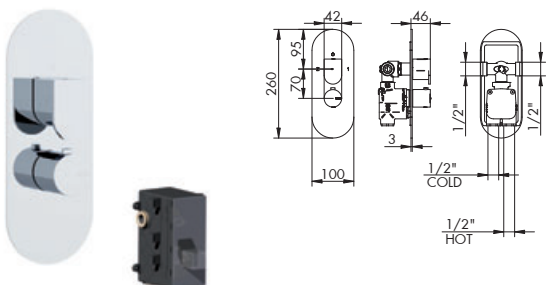

MISCELATORE TERMOSTATICO INCASSO C/ DEVIATORE 2 USCITE

- > cartuccia termostatica
- > deviatore a dischi ceramici 2 uscite c/chiusura
- > interasse 70 mm
- > ingressi inferiori da 1/2"
- > incasso con B-Box
- > piastra unica
- > 2 maniglie
- > uscite laterali da 1/2"
- > incasso regolabile min 76

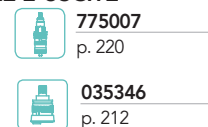

PARTI ESTERNE - CROMATO		PARTI ESTERNE - ALTRE FINITURE	
01-7212/2/P/E	€	XX-7212/2/P/E	€ x M*
<b>PARTE INCASSO</b>			
484021	info pag. 181 €		
<b>PREZZO TOTALE</b>		€	

7212/3/P/E + 484022

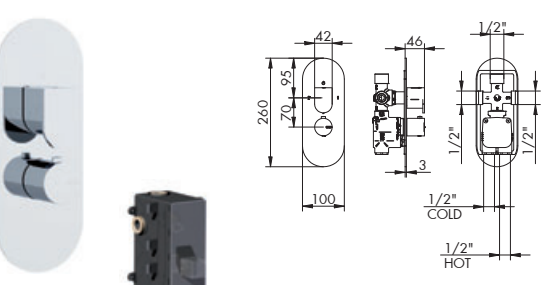

MISCELATORE TERMOSTATICO INCASSO C/DEVIATORE 3 USCITE

- > cartuccia termostatica
- > deviatore a dischi ceramici 3 uscite c/chiusura
- > interasse 70 mm
- > ingressi inferiori da 1/2"
- > incasso con B-Box
- > piastra unica
- > 2 maniglie
- > uscite laterali e superiore da 1/2"
- > incasso regolabile min 76

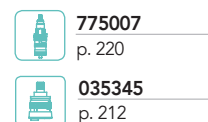

PARTI ESTERNE - CROMATO		PARTI ESTERNE - ALTRE FINITURE	
01-7212/3/P/E	€	XX-7212/3/P/E	€ x M*
<b>PARTE INCASSO</b>			
484022	info pag. 181 €		
<b>PREZZO TOTALE</b>		€	

7212/4/P/E + 484023

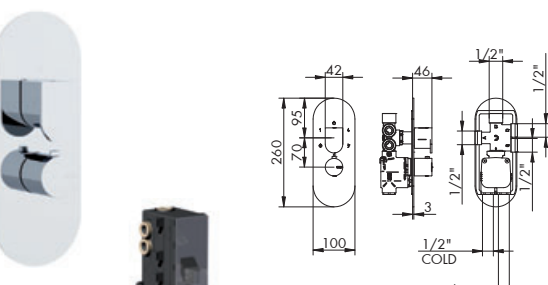

MISCELATORE TERMOSTATICO INCASSO C/DEVIATORE 4 USCITE

- > deviatore a dischi ceramici 4 uscite c/doppia chiusura
- > interasse 70 mm
- > ingressi inferiori da 1/2"
- > incasso in ottone con B-Box
- > piastra unica
- > 2 maniglie
- > uscite laterali e superiore da 1/2"
- > incasso regolabile min 76

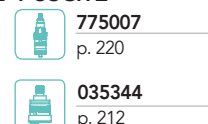

PARTI ESTERNE - CROMATO		PARTI ESTERNE - ALTRE FINITURE	
01-7212/4/P/E	€	XX-7212/4/P/E	€ x M*
<b>PARTE INCASSO</b>			
484023	info pag. 181 €		
<b>PREZZO TOTALE</b>		€	

6312/PE + 484020

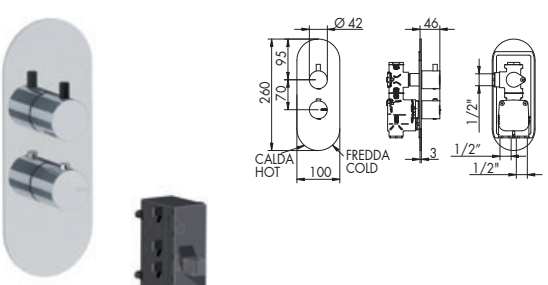

MISCELATORE TERMOSTATICO INCASSO 1 USCITA

- > cartuccia termostatica
- > vitone ceramico 90°
- > apertura con rotazione antioraria
- > ingressi inferiori da 1/2"
- > incasso con B-Box
- > piastra unica
- > interasse 70 mm
- > uscita laterale destra da 1/2"
- > incasso regolabile min 76
- > 2 maniglie c/leva stilo

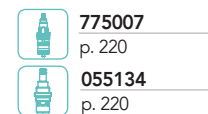

PARTI ESTERNE - CROMATO		PARTI ESTERNE - ALTRE FINITURE	
01-6312/PE-01	leva in finitura €	XX-6312/PE-XX	leva in finitura € x M*
01-6312/PE-66	leva bianco op. €	XX-6312/PE-66	leva bianco op. € x M*
01-6312/PE-67	leva nero op. €	XX-6312/PE-67	leva nero op. € x M*
<b>PARTE INCASSO</b>			
484020	info pag. 181 €		
<b>PREZZO TOTALE</b>		€	



6312/PME + 484020

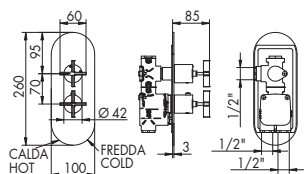

MISCELATORE TERMOSTATICO INCASSO 1 USCITA

- > cartuccia termostatica
- > vitone ceramico 90°
- > apertura con rotazione antioraria
- > interasse 70 mm
- > ingressi inferiori da 1/2"
- > incasso con B-Box
- > piastra unica
- > uscita laterale destra da 1/2"
- > incasso regolabile min 76
- > 2 maniglie a croce

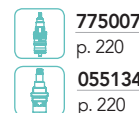

PARTI ESTERNE - CROMATO		PARTI ESTERNE - ALTRE FINITURE	
01-6312/PME	€	XX-6312/PME	€
<b>PARTE INCASSO</b>			
484020	info pag. 181	€	
<b>PREZZO TOTALE</b>		€	

6312/2/PE + 484021

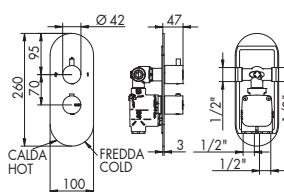

MISCELATORE TERMOSTATICO INCASSO C/ DEVIATORE 2 USCITE

- > cartuccia termostatica
- > deviatore a dischi ceramici 2 uscite c/chiusura
- > interasse 70 mm
- > ingressi inferiori da 1/2"
- > incasso con B-Box
- > piastra unica
- > uscite laterali da 1/2"
- > incasso regolabile min 76
- > 2 maniglie c/leva stilo



PARTI ESTERNE - CROMATO		PARTI ESTERNE - ALTRE FINITURE	
01-6312/2/PE-01	leva in finitura €	XX-6312/2/PE-XX	leva in finitura € x M*
01-6312/2/PE-66	leva bianco op. €	XX-6312/2/PE-66	leva bianco op. € x M*
01-6312/2/PE-67	leva nero op. €	XX-6312/2/PE-67	leva nero op. € x M*
<b>PARTE INCASSO</b>			
484021	info pag. 181	€	
<b>PREZZO TOTALE</b>		€	

6312/2/PME + 484021

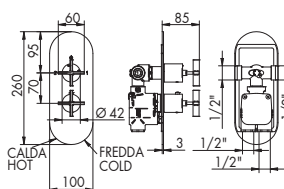

MISCELATORE TERMOSTATICO INCASSO C/ DEVIATORE 2 USCITE

- > cartuccia termostatica
- > deviatore a dischi ceramici 2 uscite c/chiusura
- > interasse 70 mm
- > ingressi inferiori da 1/2"
- > incasso con B-Box
- > piastra unica
- > 2 maniglie a croce
- > uscite laterali da 1/2"
- > incasso regolabile min 76



PARTI ESTERNE - CROMATO		PARTI ESTERNE - ALTRE FINITURE	
01-6312/2/PME	€	XX-6312/2/PME	€
<b>PARTE INCASSO</b>			
484021	info pag. 181	€	
<b>PREZZO TOTALE</b>		€	

6312/3/PE + 484022

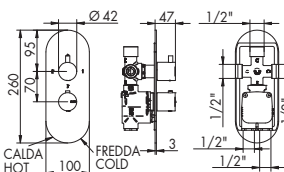

MISCELATORE TERMOSTATICO INCASSO C/DEVIATORE 3 USCITE

- > cartuccia termostatica
- > deviatore a dischi ceramici 3 uscite c/chiusura
- > interasse 70 mm
- > ingressi inferiori da 1/2"
- > incasso con B-Box
- > piastra unica
- > uscite laterali da 1/2"
- > incasso regolabile min 76
- > 2 maniglie c/leva stilo



PARTI ESTERNE - CROMATO		PARTI ESTERNE - ALTRE FINITURE	
01-6312/3/PE-01	leva in finitura €	XX-6312/3/PE-XX	leva in finitura € x M*
01-6312/3/PE-66	leva bianco op. €	XX-6312/3/PE-66	leva bianco op. € x M*
01-6312/3/PE-67	leva nero op. €	XX-6312/3/PE-67	leva nero op. € x M*
<b>PARTE INCASSO</b>			
484022	info pag. 181	€	
<b>PREZZO TOTALE</b>		€	

6312/3/PME + 484022

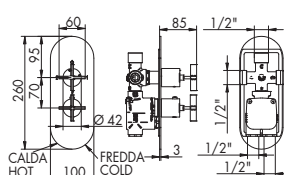

MISCELATORE TERMOSTATICO INCASSO C/DEVIATORE 3 USCITE

- > cartuccia termostatica
- > deviatore a dischi ceramici 3 uscite c/chiusura
- > interasse 70 mm
- > ingressi inferiori da 1/2"
- > incasso con B-Box
- > piastra unica
- > 2 maniglie a croce
- > uscite laterali da 1/2"
- > incasso regolabile min 76



PARTI ESTERNE - CROMATO		PARTI ESTERNE - ALTRE FINITURE	
01-6312/3/PME	€	XX-6312/3/PME	€
<b>PARTE INCASSO</b>			
484022	info pag. 181	€	
<b>PREZZO TOTALE</b>		€	

6312/4/PE + 484023

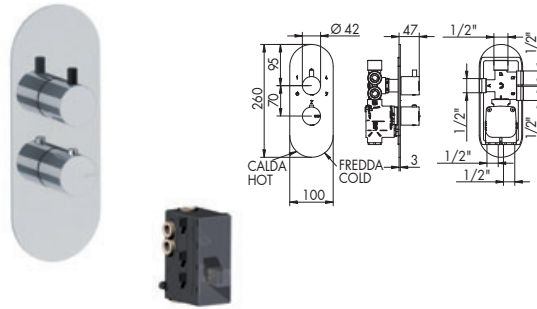

MISCELATORE TERMOSTATICO INCASSO C/DEVIATORE 4 USCITE

- > cartuccia termostatica
- > deviatore a dischi ceramici 4 uscite c/doppia chiusura
- > interasse 70 mm
- > ingressi inferiori da 1/2"
- > incasso con B-Box
- > piastra unica
- > uscite laterali e superiore da 1/2"
- > incasso regolabile min 76
- > 2 maniglie c/leva stilo

	775007	p. 220
	035344	p. 212

PARTI ESTERNE - CROMATO

01-6312/4/PE-01	leva in finitura	€
01-6312/4/PE-66	leva bianco op.	€
01-6312/4/PE-67	leva nero op.	€

PARTI ESTERNE - ALTRE FINITURE

XX-6312/4/PE-XX	leva in finitura	€	x M*
XX-6312/4/PE-66	leva bianco op.	€	x M*
XX-6312/4/PE-67	leva nero op.	€	x M*

PARTE INCASSO

484023	info pag. 181	€
--------	---------------	---

PREZZO TOTALE	€
---------------	---

6312/4/PME + 484023

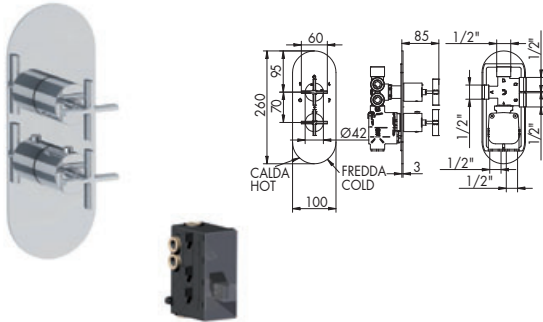

MISCELATORE TERMOSTATICO INCASSO C/DEVIATORE 4 USCITE

- > cartuccia termostatica
- > deviatore a dischi ceramici 4 uscite c/doppia chiusura
- > interasse 70 mm
- > ingressi inferiori da 1/2"
- > incasso con B-Box
- > piastra unica
- > 2 maniglie a croce
- > uscite laterali e superiore da 1/2"
- > incasso regolabile min 76

	775007	p. 220
	035344	p. 212

PARTI ESTERNE - CROMATO

01-6312/4/PME		€
---------------	--	---

PARTI ESTERNE - ALTRE FINITURE

XX-6312/4/PME		€	x M*
---------------	--	---	------

PARTE INCASSO

484023	info pag. 181	€
--------	---------------	---

PREZZO TOTALE	€
---------------	---

0812/K/E + 484020

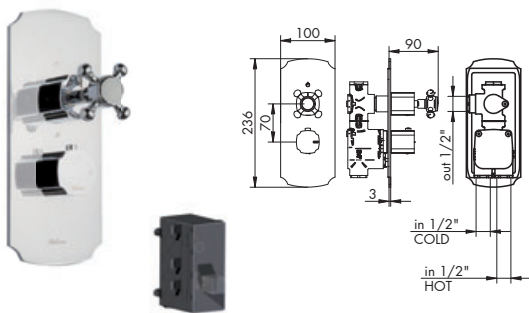

MISCELATORE TERMOSTATICO INCASSO 1 USCITA

- > cartuccia termostatica
- > vitone ceramico 90°
- > apertura con rotazione antioraria
- > ingressi inferiori da 1/2"
- > incasso con B-Box
- > piastra unica
- > attivatore maniglia a croce
- > interasse 70 mm
- > uscita laterale destra da 1/2"
- > incasso regolabile min 76
- > 2 maniglie

	775007	p. 220
	055134	p. 220

PARTI ESTERNE - CROMATO

01-0812/K/E		€
-------------	--	---

PARTI ESTERNE - ALTRE FINITURE

XX-0812/K/E		€	x M*
-------------	--	---	------

PARTE INCASSO

484020	info pag. 181	€
--------	---------------	---

PREZZO TOTALE	€
---------------	---

0812/2/K/E + 484021

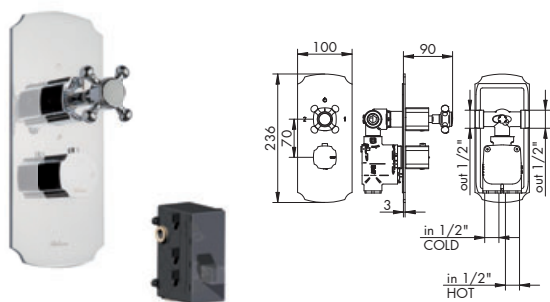

MISCELATORE TERMOSTATICO INCASSO C/DEVIATORE 2 USCITE

- > cartuccia termostatica
- > deviatore a dischi ceramici 2 uscite c/chiusura
- > interasse 70 mm
- > ingressi inferiori da 1/2"
- > incasso con B-Box
- > piastra unica classic
- > deviatore maniglia a croce
- > uscite laterali da 1/2"
- > incasso regolabile min 76
- > 2 maniglie

	775007	p. 220
	035346	p. 212

PARTI ESTERNE - CROMATO

01-0812/2/K/E		€
---------------	--	---

PARTI ESTERNE - ALTRE FINITURE

XX-0812/2/K/E		€	x M*
---------------	--	---	------

PARTE INCASSO

484021	info pag. 181	€
--------	---------------	---

PREZZO TOTALE	€
---------------	---

0812/3/K/E + 484022

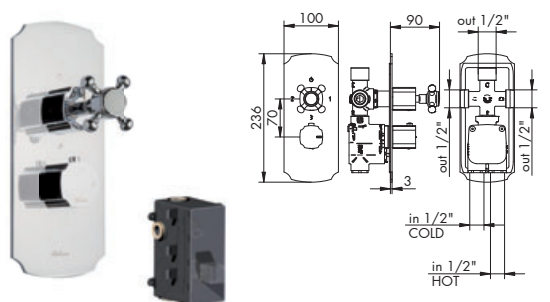

MISCELATORE TERMOSTATICO INCASSO C/DEVIATORE 3 USCITE

- > cartuccia termostatica
- > deviatore a dischi ceramici 3 uscite c/chiusura
- > interasse 70 mm
- > ingressi inferiori da 1/2"
- > incasso con B-Box
- > piastra unica classic
- > deviatore maniglia a croce
- > uscite laterali e superiore da 1/2"
- > incasso regolabile min 76
- > 2 maniglie

	775007	p. 220
	035345	p. 212

PARTI ESTERNE - CROMATO

01-0812/3/K/E		€
---------------	--	---

PARTI ESTERNE - ALTRE FINITURE

XX-0812/3/K/E		€	x M*
---------------	--	---	------

PARTE INCASSO

484022	info pag. 181	€
--------	---------------	---

PREZZO TOTALE	€
---------------	---



8312/P/E+ 484020 | BIJOUX

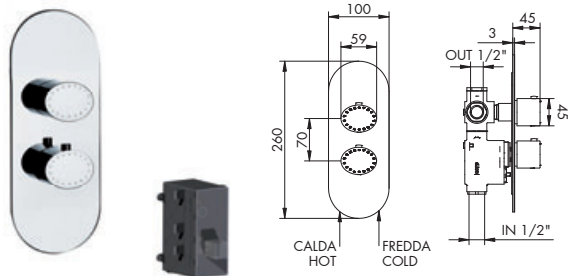

MISCELATORE TERMOSTATICO INCASSO 1 USCITA C/SWAROVSKI

- > cartuccia termostatica
- > vitone ceramico 90°
- > apertura con rotazione antioraria
- > ingressi inferiori da 1/2"
- > incasso con B-Box
- > posizionabile orizzontalmente
- > piastra unica
- > interasse 70 mm
- > uscite laterali destra da 1/2"
- > incasso regolabile min 76
- > 2 maniglie

775007 p. 220

055134 p. 220

PARTI ESTERNE - CROMATO

01-8312/P/E €

PARTI ESTERNE - ALTRE FINITURE

XX-8312/P/E € x M\*

PARTE INCASSO

484020 info pag. 181 €

PREZZO TOTALE €

8312/2/P/E + 484021 | BIJOUX

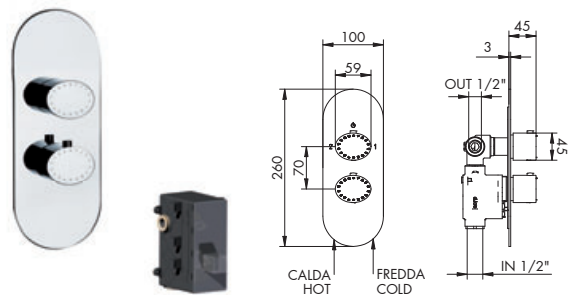

MISCELATORE TERMOSTATICO INCASSO C/DEVIATORE 2 USCITE C/SWAROVSKI

- > cartuccia termostatica
- > deviatore a dischi ceramici 2 uscite c/chiusura
- > interasse 70 mm
- > ingressi inferiori da 1/2"
- > incasso con B-Box
- > piastra unica
- > uscite laterali da 1/2"
- > incasso regolabile min 76
- > 2 maniglie con SWAROVSKI

775007 p. 220

035346 p. 212

PARTI ESTERNE - CROMATO

01-8312/2/P/E €

PARTI ESTERNE - ALTRE FINITURE

XX-8312/2/P/E € x M\*

PARTE INCASSO

484021 info pag. 181 €

PREZZO TOTALE €

8312/3/P/E + 484022 | BIJOUX

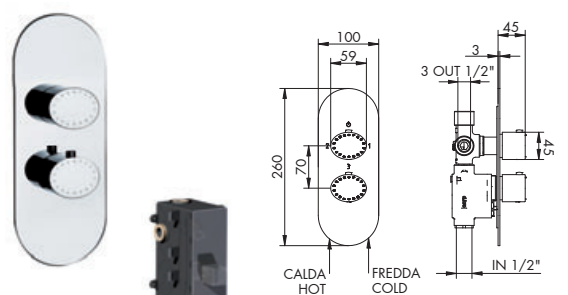

MISCELATORE TERMOSTATICO INCASSO C/DEVIATORE 3 USCITE C/SWAROVSKI

- > cartuccia termostatica
- > deviatore a dischi ceramici 3 uscite c/chiusura
- > interasse 70 mm
- > ingressi inferiori da 1/2"
- > incasso con B-Box
- > piastra unica
- > uscite laterali e superiore da 1/2"
- > incasso regolabile min 76
- > 2 maniglie con SWAROVSKI

775007 p. 220

035345 p. 212

PARTI ESTERNE - CROMATO

01-8312/3/P/E €

PARTI ESTERNE - ALTRE FINITURE

XX-8312/3/P/E € x M\*

PARTE INCASSO

484022 info pag. 181 €

PREZZO TOTALE €

8312/4/P/E + 484023 | BIJOUX

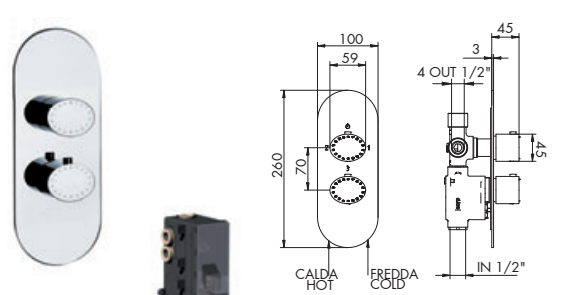

MISCELATORE TERMOSTATICO INCASSO C/DEVIATORE 4 USCITE C/SWAROVSKI

- > cartuccia termostatica
- > deviatore a dischi ceramici 4 uscite c/doppia chiusura
- > interasse 70 mm
- > ingressi inferiori da 1/2"
- > incasso in ottone con B-Box
- > piastra unica
- > uscite laterali e superiore da 1/2"
- > incasso regolabile min 76
- > 2 maniglie con SWAROVSKI

775007 p. 220

035344 p. 212

PARTI ESTERNE - CROMATO

01-8312/4/P/E €

PARTI ESTERNE - ALTRE FINITURE

XX-8312/4/P/E € x M\*

PARTE INCASSO

484023 info pag. 181 €

PREZZO TOTALE €

3312/P/E + 484020

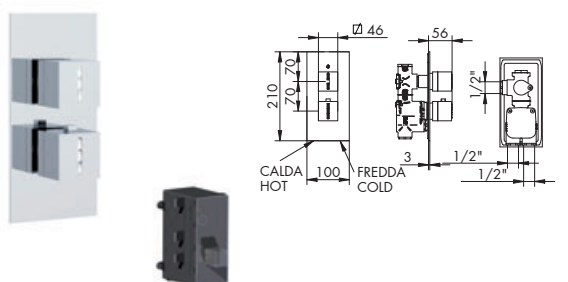

MISCELATORE TERMOSTATICO INCASSO 1 USCITA C/SWAROVSKI

- > cartuccia termostatica
- > vitone ceramico 90°
- > apertura con rotazione antioraria
- > ingressi inferiori da 1/2"
- > incasso con B-Box
- > posizionabile orizzontalmente
- > piastra unica
- > interasse 70 mm
- > uscite laterali destra da 1/2"
- > incasso regolabile min 76
- > 2 maniglie

775007 p. 220

055134 p. 220

PARTI ESTERNE - CROMATO

01-3312/P/E €

PARTI ESTERNE - ALTRE FINITURE

XX-3312/P/E € x M\*

PARTE INCASSO

484020 info pag. 181 €

PREZZO TOTALE €

3312/2/P/E + 484021

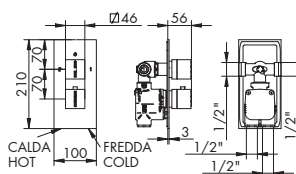

MISCELATORE TERMOSTATICO INCASSO C/ DEVIATORE 2 USCITE C/SWAROVSKI

- > cartuccia termostatica
- > deviatore a dischi ceramici 2 uscite c/chiusura
- > interasse 70 mm
- > ingressi inferiori da 1/2" > uscite laterali da 1/2"
- > incasso con B-Box > incasso regolabile min 76
- > piastra unica
- > 2 maniglie con SWAROVSKI



PARTI ESTERNE - CROMATO		PARTI ESTERNE - ALTRE FINITURE	
01-3312/2/P/E	€	XX-3312/2/P/E	€ x M*
PARTE INCASSO			
484021	info pag. 181	€	
PREZZO TOTALE		€	

3312/3/P/E + 484022

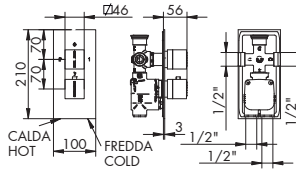

MISCELATORE TERMOSTATICO INCASSO C/DEVIATORE 3 USCITE C/SWAROVSKI

- > cartuccia termostatica
- > deviatore a dischi ceramici 3 uscite c/chiusura
- > interasse 70 mm
- > ingressi inferiori da 1/2" > uscite laterali e superiore da 1/2"
- > incasso con B-Box > incasso regolabile min 76
- > piastra unica
- > 2 maniglie con SWAROVSKI



PARTI ESTERNE - CROMATO		PARTI ESTERNE - ALTRE FINITURE	
01-3312/3/P/E	€	XX-3312/3/P/E	€ x M*
PARTE INCASSO			
484022	info pag. 181	€	
PREZZO TOTALE		€	

3312/4/P/E + 484023

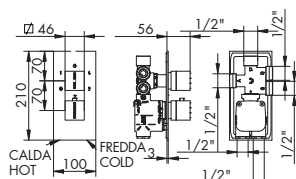

MISCELATORE TERMOSTATICO INCASSO C/DEVIATORE 4 USCITE C/SWAROVSKI

- > cartuccia termostatica
- > deviatore a dischi ceramici 4 uscite c/doppia chiusura
- > interasse 70 mm
- > ingressi inferiori da 1/2" > uscite laterali e superiore da 1/2"
- > incasso con B-Box > incasso regolabile min 76
- > piastra unica
- > 2 maniglie con SWAROVSKI



PARTI ESTERNE - CROMATO		PARTI ESTERNE - ALTRE FINITURE	
01-3312/4/P/E	€	XX-3312/4/P/E	€ x M*
PARTE INCASSO			
484023	info pag. 181	€	
PREZZO TOTALE		€	

4512/P/E + 484020

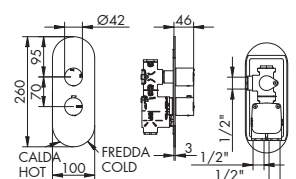

MISCELATORE TERMOSTATICO INCASSO 1 USCITA

- > cartuccia termostatica
- > vitone ceramico 90°
- > apertura con rotazione antioraria > interasse 70 mm
- > ingressi inferiori da 1/2" > uscite laterali destra da 1/2"
- > incasso in ottone con B-Box
- > incasso regolabile min 76
- > posizionabile orizzontalmente > piastra unica
- > 2 maniglie



PARTI ESTERNE - INOX AISI 316L	
82-4512/P/E	€
PARTE INCASSO	
484020	info pag. 181
PREZZO TOTALE	
€	

4512/PQ/E + 484020

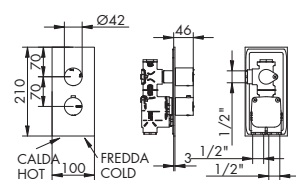

MISCELATORE TERMOSTATICO INCASSO 1 USCITA

- > cartuccia termostatica
- > vitone ceramico 90°
- > apertura con rotazione antioraria > interasse 70 mm
- > ingressi inferiori da 1/2" > uscite laterali destra da 1/2"
- > incasso in ottone con B-Box
- > incasso regolabile min 76
- > posizionabile orizzontalmente > piastra unica rettangolare
- > 2 maniglie



PARTI ESTERNE - INOX AISI 316L	
82-4512/PQ/E	€
PARTE INCASSO	
484020	info pag. 181
PREZZO TOTALE	
€	

RICAMBI IMMEDIATI



XX = CODICE FINITURA RICHIESTA: per identificare codice corretto vedi pag. 240  
 M\* = MOLTIPLICATORE: per calcolare il prezzo delle altre finiture vedi tabella pag. 240





## 4512/2/P/E + 484021

NEW

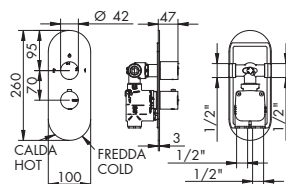

## MISCELATORE TERMOSTATICO INCASSO C/ DEVIATORE 2 USCITE

- > cartuccia termostatica
- > deviatore a dischi ceramici 2 uscite c/chiusura
- > interasse 70 mm
- > ingressi inferiori da 1/2" > uscite laterali da 1/2"
- > incasso in ottone con B-Box
- > incasso regolabile min 76
- > piastra unica
- > 2 maniglie



775007

p. 220



035346

p. 212

## PARTI ESTERNE - INOX AISI 316L

82-4512/2/P/E

€

## PARTE INCASSO

484021 info pag. 181

€

## PREZZO TOTALE

€

## 4512/2/PQ/E + 484021

NEW

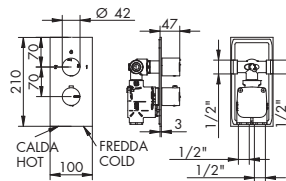

## MISCELATORE TERMOSTATICO INCASSO C/ DEVIATORE 2 USCITE

- > cartuccia termostatica
- > deviatore a dischi ceramici 2 uscite c/chiusura
- > interasse 70 mm
- > ingressi inferiori da 1/2" > uscite laterali da 1/2"
- > incasso in ottone con B-Box
- > incasso regolabile min 76
- > piastra unica rettangolare
- > 2 maniglie



775007

p. 220



035346

p. 212

## PARTI ESTERNE - INOX AISI 316L

82-4512/2/PQ/E

€

## PARTE INCASSO

484021 info pag. 181

€

## PREZZO TOTALE

€

## 4512/3/P/E + 484022

NEW

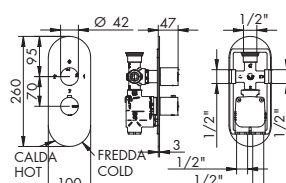

## MISCELATORE TERMOSTATICO INCASSO C/DEVIATORE 3 USCITE

- > cartuccia termostatica
- > deviatore a dischi ceramici 3 uscite c/chiusura
- > interasse 70 mm
- > ingressi inferiori da 1/2" > uscite laterali e superiore da 1/2"
- > incasso in ottone con B-Box
- > incasso regolabile min 76
- > piastra unica
- > 2 maniglie



775007

p. 220



035345

p. 212

## PARTI ESTERNE - INOX AISI 316L

82-4512/3/P/E

€

## PARTE INCASSO

484022 info pag. 181

€

## PREZZO TOTALE

€

## 4512/3/PQ/E + 484022

NEW

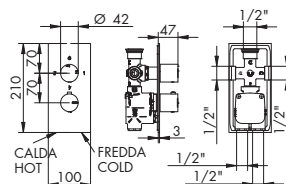

## MISCELATORE TERMOSTATICO INCASSO C/DEVIATORE 3 USCITE

- > cartuccia termostatica
- > deviatore a dischi ceramici 3 uscite c/chiusura
- > interasse 70 mm
- > ingressi inferiori da 1/2" > uscite laterali e superiore da 1/2"
- > incasso in ottone con B-Box
- > incasso regolabile min 76
- > piastra unica rettangolare
- > 2 maniglie



775007

p. 220



035345

p. 212

## PARTI ESTERNE - INOX AISI 316L

82-4512/3/PQ/E

€

## PARTE INCASSO

484022 info pag. 181

€

## PREZZO TOTALE

€

## 4512/4/P/E + 484023

NEW

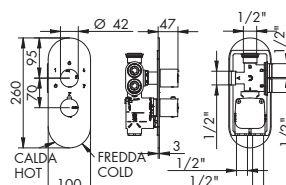

## MISCELATORE TERMOSTATICO INCASSO C/DEVIATORE 4 USCITE

- > cartuccia termostatica
- > deviatore a dischi ceramici 4 uscite c/doppia chiusura
- > interasse 70 mm
- > ingressi inferiori da 1/2" > uscite laterali e superiore da 1/2"
- > incasso in ottone con B-Box
- > incasso regolabile min 76
- > piastra unica rettangolare
- > 2 maniglie



775007

p. 220



035344

p. 212

## PARTI ESTERNE - INOX AISI 316L

82-4512/4/P/E

€

## PARTE INCASSO

484023 info pag. 181

€

## PREZZO TOTALE

€



CARTUCCIA TERMOSTATICA



VITONE CERAMICO



CARTUCCIA DEVIATRICE

## 4512/4/PQ/E + 484023

NEW

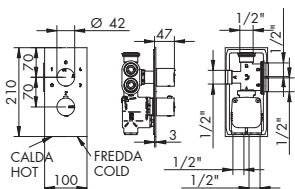

## MISCELATORE TERMOSTATICO INCASSO C/DEVIATORE 4 USCITE

- > cartuccia termostatica
- > deviatore a dischi ceramici 4 uscite c/doppia chiusura
- > interasse 70 mm
- > ingressi inferiori da 1/2" > uscite laterali e superiore da 1/2"
- > incasso in ottone con B-Box
- > incasso regolabile min 76
- > piastra unica rettangolare > 2 maniglie

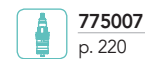

775007

p. 220



035344

p. 212

## PARTI ESTERNE - INOX AISI 316L

82-4512/4/PQ/E

€

## PARTE INCASSO

484023 info pag. 181

€

## PREZZO TOTALE

€

## 4812/P/E + 484020 (JEANS)

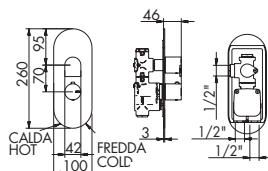

## MISCELATORE TERMOSTATICO INCASSO 1 USCITA

- > cartuccia termostatica
- > vitone ceramico 90°
- > apertura con rotazione antioraria > interasse 70 mm
- > ingressi inferiori da 1/2" > uscite laterali destra da 1/2"
- > incasso con B-Box > incasso regolabile min 76
- > posizionabile orizzontalmente > piastra unica
- > 2 maniglie



775007

p. 220



055134

p. 220

## PARTI ESTERNE - CROMATO

01-4812/P/E €

## PARTI ESTERNE - ALTRE FINITURE

XX-4812/P/E

€

x M\*

## PARTE INCASSO

484020 info pag. 181 €

## PREZZO TOTALE

€

## 4812/PQ/E + 484020 (JEANS)

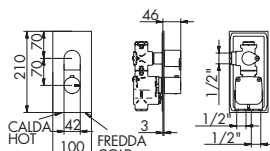

## MISCELATORE TERMOSTATICO INCASSO 1 USCITA

- > cartuccia termostatica
- > vitone ceramico 90°
- > apertura con rotazione antioraria > interasse 70 mm
- > ingressi inferiori da 1/2" > uscite laterali destra da 1/2"
- > incasso con B-Box > incasso regolabile min 76
- > posizionabile orizzontalmente > piastra unica rettangolare
- > 2 maniglie



775007

p. 220



055134

p. 220

## PARTI ESTERNE - CROMATO

01-4812/PQ/E €

## PARTI ESTERNE - ALTRE FINITURE

XX-4812/PQ/E

€

x M\*

## PARTE INCASSO

484020 info pag. 181 €

## PREZZO TOTALE

€

## 4812/2/P/E + 484021 (JEANS)

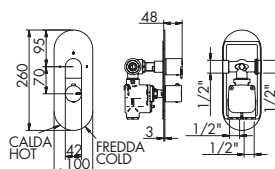

## MISCELATORE TERMOSTATICO INCASSO C/ DEVIATORE 2 USCITE

- > cartuccia termostatica
- > deviatore a dischi ceramici c/chiusura 2 uscite c/chiusura
- > interasse 70 mm
- > ingressi inferiori da 1/2" > uscite laterali da 1/2"
- > incasso con B-Box > incasso regolabile min 76
- > piastra unica
- > 2 maniglie



775007

p. 220



035346

p. 212

## PARTI ESTERNE - CROMATO

01-4812/2/P/E €

## PARTI ESTERNE - ALTRE FINITURE

XX-4812/2/P/E

€

x M\*

## PARTE INCASSO

484021 info pag. 181 €

## PREZZO TOTALE

€

## 4812/2/PQ/E + 484021 (JEANS)

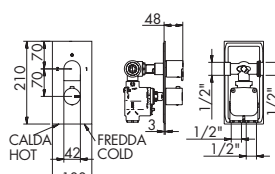

## MISCELATORE TERMOSTATICO INCASSO C/ DEVIATORE 2 USCITE

- > cartuccia termostatica
- > deviatore a dischi ceramici 2 uscite c/chiusura
- > interasse 70 mm
- > ingressi inferiori da 1/2" > uscite laterali da 1/2"
- > incasso con B-Box > incasso regolabile min 76
- > piastra unica rettangolare
- > 2 maniglie



775007

p. 220



035346

p. 212

## PARTI ESTERNE - CROMATO

01-4812/2/PQ/E €

## PARTI ESTERNE - ALTRE FINITURE

XX-4812/2/PQ/E

€

x M\*

## PARTE INCASSO

484021 info pag. 181 €

## PREZZO TOTALE

€

## RICAMBI IMMEDIATI



CARTUCCIA TERMOSTATICA



VITONE CERAMICO



CARTUCCIA DEVIATRICE

XX = CODICE FINITURA RICHIESTA: per identificare codice corretto vedi pag. 240  
M\* = MOLTIPLICATORE: per calcolare il prezzo delle altre finiture vedi tabella pag. 240

4812/3/P/E + 484022 (JEANS)

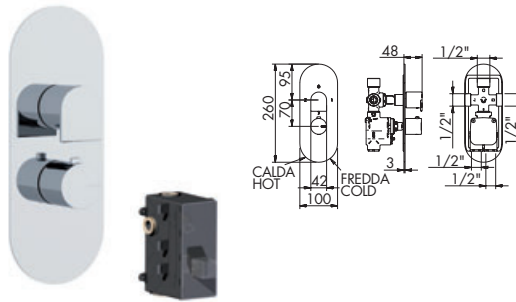

MISCELATORE TERMOSTATICO INCASSO C/DEVIATORE 3 USCITE

- > cartuccia termostatica
- > deviatore a dischi ceramici 3 uscite c/chiusura
- > interasse 70 mm
- > ingressi inferiori da 1/2"
- > incasso con B-Box
- > piastra unica
- > 2 maniglie
- > uscite laterali e superiore da 1/2"
- > incasso regolabile min 76

	<b>775007</b> p. 220
	<b>035345</b> p. 212

<b>PARTI ESTERNE - CROMATO</b>		<b>PARTI ESTERNE - ALTRE FINITURE</b>	
01-4812/3/P/E	€	<b>XX-4812/3/P/E</b>	€ <b>x M*</b>
<b>PARTE INCASSO</b>			
484022	info pag. 181	€	
<b>PREZZO TOTALE</b>		€	

4812/3/PQ/E + 484022 (JEANS)

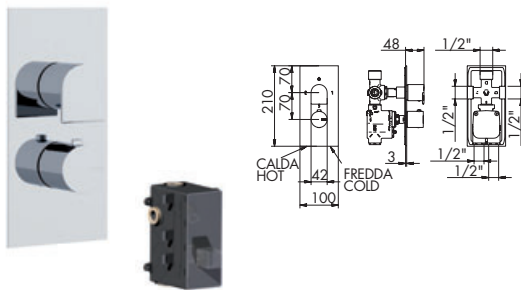

MISCELATORE TERMOSTATICO INCASSO C/DEVIATORE 3 USCITE

- > cartuccia termostatica
- > deviatore a dischi ceramici 3 uscite c/chiusura
- > interasse 70 mm
- > ingressi inferiori da 1/2"
- > incasso con B-Box
- > piastra unica rettangolare
- > 2 maniglie
- > uscite laterali e superiore da 1/2"
- > incasso regolabile min 76

	<b>775007</b> p. 220
	<b>035345</b> p. 212

<b>PARTI ESTERNE - CROMATO</b>		<b>PARTI ESTERNE - ALTRE FINITURE</b>	
01-4812/3/PQ/E	€	<b>XX-4812/3/PQ/E</b>	€ <b>x M*</b>
<b>PARTE INCASSO</b>			
484022	info pag. 181	€	
<b>PREZZO TOTALE</b>		€	

4812/4/P/E + 484023 (JEANS)

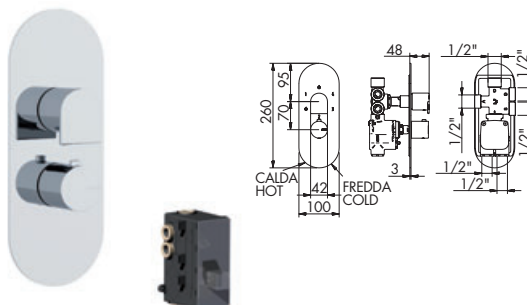

MISCELATORE TERMOSTATICO INCASSO C/DEVIATORE 4 USCITE

- > cartuccia termostatica
- > deviatore a dischi ceramici 4 uscite c/doppia chiusura
- > interasse 70 mm
- > ingressi inferiori da 1/2"
- > incasso con B-Box
- > piastra unica
- > 2 maniglie
- > uscite laterali e superiore da 1/2"
- > incasso regolabile min 76

	<b>775007</b> p. 220
	<b>035344</b> p. 212

<b>PARTI ESTERNE - CROMATO</b>		<b>PARTI ESTERNE - ALTRE FINITURE</b>	
01-4812/4/P/E	€	<b>XX-4812/4/P/E</b>	€ <b>x M*</b>
<b>PARTE INCASSO</b>			
484023	info pag. 181	€	
<b>PREZZO TOTALE</b>		€	

4812/4/PQ/E + 484023 (JEANS)

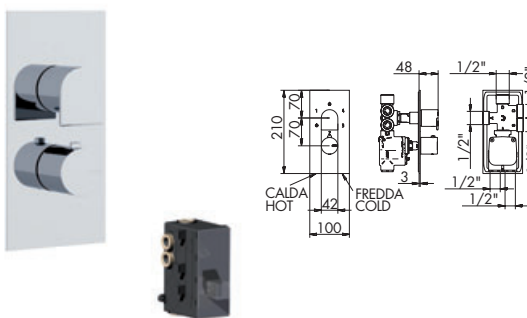

MISCELATORE TERMOSTATICO INCASSO C/DEVIATORE 4 USCITE

- > cartuccia termostatica
- > deviatore a dischi ceramici 4 uscite c/doppia chiusura
- > interasse 70 mm
- > ingressi inferiori da 1/2"
- > incasso con B-Box
- > piastra unica rettangolare
- > 2 maniglie
- > uscite laterali e superiore da 1/2"
- > incasso regolabile min 76

	<b>775007</b> p. 220
	<b>035344</b> p. 212

<b>PARTI ESTERNE - CROMATO</b>		<b>PARTI ESTERNE - ALTRE FINITURE</b>	
01-4812/4/PQ/E	€	<b>XX-4812/4/PQ/E</b>	€ <b>x M*</b>
<b>PARTE INCASSO</b>			
484023	info pag. 181	€	
<b>PREZZO TOTALE</b>		€	

4012/K/E + 484020

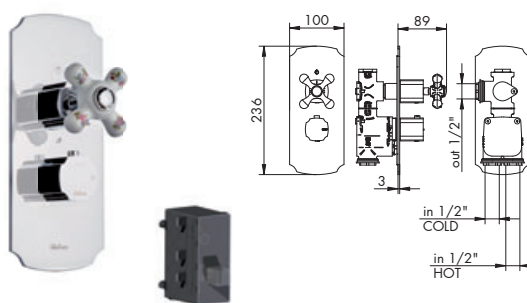

MISCELATORE TERMOSTATICO INCASSO 1 USCITA

- > cartuccia termostatica
- > apertura con rotazione antioraria
- > ingressi inferiori da 1/2"
- > incasso con B-Box
- > piastra unica
- > attivatore maniglia a croce in porcellana bianca o decorata
- > vitone ceramico 90°
- > interasse 70 mm
- > uscita laterale destra da 1/2"
- > incasso regolabile min 76
- > 2 maniglie

	<b>775007</b> p. 220
	<b>055134</b> p. 220

<b>PARTI ESTERNE - CROMATO</b>		<b>PARTI ESTERNE - ALTRE FINITURE</b>	
01-4012/K/E	decorata €	<b>XX-4012/K/E</b>	decorata € <b>x M*</b>
01-4012/K/B/E	bianca €	<b>XX-4012/K/B/E</b>	bianca € <b>x M*</b>
<b>PARTE INCASSO</b>			
484020	info pag. 181	€	
<b>PREZZO TOTALE</b>		€	

4012/2/K/E + 484021

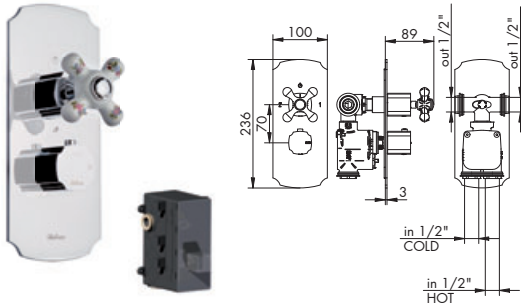

MISCELATORE TERMOSTATICO INCASSO C/DEVIATORE 2 USCITE

- > cartuccia termostatica
- > deviatore a dischi ceramici 2 uscite c/chiusura
- > interasse 70 mm
- > uscite laterali da 1/2"
- > incasso regolabile min 76
- > 2 maniglie
- > deviatore maniglia a croce in porcellana bianca o decorata

- 775007 p. 220
- 035346 p. 212

PARTI ESTERNE - CROMATO

- 01-4012/2/K/E decorata €
- 01-4012/2/K/B/E bianca €

PARTI ESTERNE - ALTRE FINITURE

- XX-4012/2/K/E decorata € x M\*
- XX-4012/2/K/B/E bianca € x M\*

PARTE INCASSO

- 484021 info pag. 181 €

PREZZO TOTALE €

4012/3/K/E + 484022

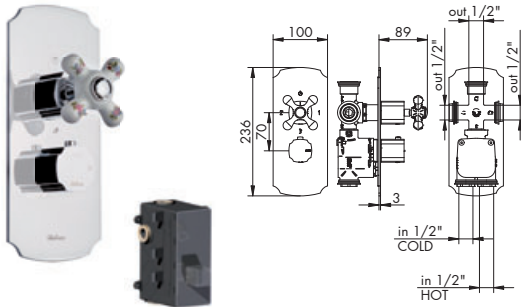

MISCELATORE TERMOSTATICO INCASSO C/DEVIATORE 3 USCITE

- > cartuccia termostatica
- > deviatore a dischi ceramici 3 uscite c/chiusura
- > interasse 70 mm
- > uscite superiore e laterali da 1/2"
- > incasso regolabile min 76
- > 2 maniglie
- > deviatore maniglia a croce in porcellana bianca o decorata

- 775007 p. 220
- 035346 p. 212

PARTI ESTERNE - CROMATO

- 01-4012/3/K/E decorata €
- 01-4012/3/K/B/E bianca €

PARTI ESTERNE - ALTRE FINITURE

- XX-4012/3/K/E decorata € x M\*
- XX-4012/3/K/B/E bianca € x M\*

PARTE INCASSO

- 484022 info pag. 181 €

PREZZO TOTALE €

4012/4/K/E + 484023

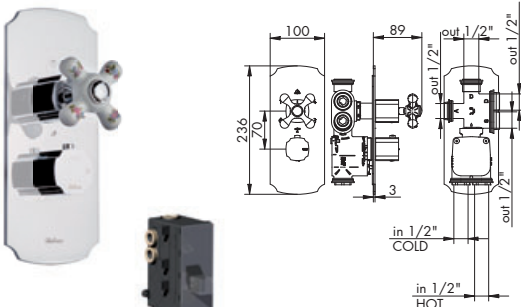

MISCELATORE TERMOSTATICO INCASSO C/DEVIATORE 4 USCITE

- > cartuccia termostatica
- > deviatore a dischi ceramici 4 uscite c/doppia chiusura
- > interasse 70 mm
- > uscite laterali e superiore da 1/2"
- > incasso regolabile min 76
- > 2 maniglie
- > deviatore maniglia a croce in porcellana bianca o decorata

- 775007 p. 220
- 035344 p. 212

PARTI ESTERNE - CROMATO

- 01-4012/4/K/E decorata €
- 01-4012/4/K/B/E bianca €

PARTI ESTERNE - ALTRE FINITURE

- XX-4012/4/K/E decorata € x M\*
- XX-4012/4/K/B/E bianca € x M\*

PARTE INCASSO

- 484023 info pag. 181 €

PREZZO TOTALE €

0512/H/PL/E + 484020

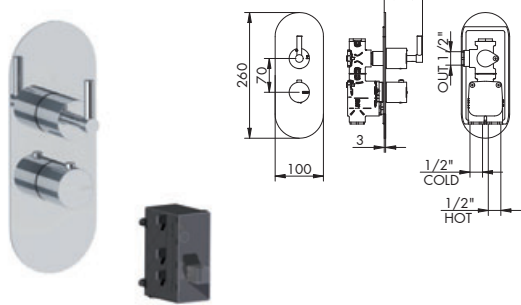

MISCELATORE TERMOSTATICO INCASSO 1 USCITA

- > cartuccia termostatica
- > vitone ceramico 90°
- > apertura con rotazione antioraria
- > ingressi inferiori da 3/4"
- > incasso con B-Box
- > posizionabile orizzontalmente
- > piastra unica
- > 2 maniglie attivatore a leva

- 775007 p. 220
- 055134 p. 220

PARTI ESTERNE - CROMATO

- 01-0512/H/PL/E €

PARTI ESTERNE - ALTRE FINITURE

- XX-0512/H/PL/E € x M\*

PARTE INCASSO

- 484020 info pag. 181 €

PREZZO TOTALE €

0512/2/PL/E + 484021

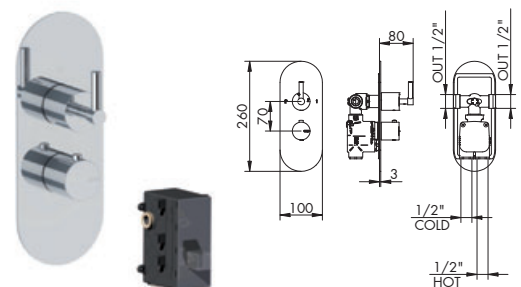

MISCELATORE TERMOSTATICO INCASSO C/DEVIATORE 2 USCITE

- > cartuccia termostatica
- > deviatore a dischi ceramici 2 uscite c/chiusura
- > interasse 70 mm
- > ingressi inferiori da 1/2"
- > incasso con B-Box
- > piastra unica
- > 2 maniglie attivatore a leva

- 775007 p. 220
- 035346 p. 212

PARTI ESTERNE - CROMATO

- 01-0512/2/PL/E €

PARTI ESTERNE - ALTRE FINITURE

- XX-0512/2/PL/E € x M\*

PARTE INCASSO

- 484021 info pag. 181 €

PREZZO TOTALE €

RICAMBI IMMEDIATI

- CARTUCCIA TERMOSTATICA
- VITONE CERAMICO
- CARTUCCIA DEVIATRICE

XX = CODICE FINITURA RICHIESTA: per identificare codice corretto vedi pag. 240  
M\* = MOLTIPLICATORE: per calcolare il prezzo delle altre finiture vedi tabella pag. 240



## 0512/3/PL/E + 484022

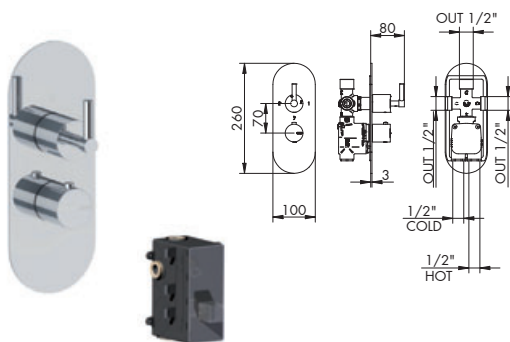

## MISCELATORE TERMOSTATICO INCASSO C/DEVIATORE 3 USCITE

- > cartuccia termostatica
- deviatore a dischi ceramici 3 uscite c/chiusura
- > interasse 70 mm
- > ingressi inferiori da 1/2" > uscite laterali e superiore da 1/2"
- > incasso con B-Box > incasso regolabile min 76
- > piastra unica
- > 2 maniglie deviatore a leva

 775007  
p. 220

 035345  
p. 212

## PARTI ESTERNE - CROMATO

01-0512/3/PL/E €

## PARTI ESTERNE - ALTRE FINITURE

XX-0512/3/PL/E € x M\*

## PARTE INCASSO

484022 info pag. 181 €

PREZZO TOTALE €

## 0512/4/PL/E + 484023

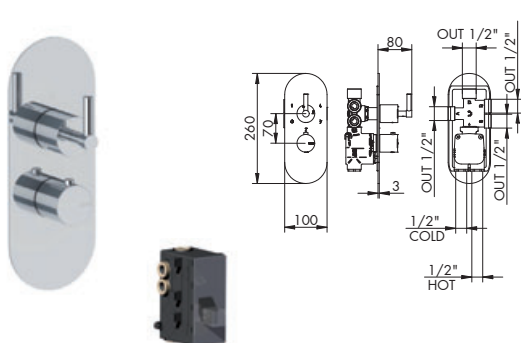

## MISCELATORE TERMOSTATICO INCASSO C/DEVIATORE 4 USCITE

- > cartuccia termostatica
- > deviatore a dischi ceramici 4 uscite c/doppia chiusura
- > interasse 70 mm
- > ingressi inferiori da 1/2" > uscite laterali e superiore da 1/2"
- > incasso con B-Box > incasso regolabile min 76
- > piastra unica > 2 maniglie deviatore a leva

 775007  
p. 220

 035344  
p. 212

## PARTI ESTERNE - CROMATO

01-0512/4/PL/E €

## PARTI ESTERNE - ALTRE FINITURE

XX-0512/4/PL/E € x M\*

## PARTE INCASSO

484023 info pag. 181 €

PREZZO TOTALE €

## 7312/P/E + 484020

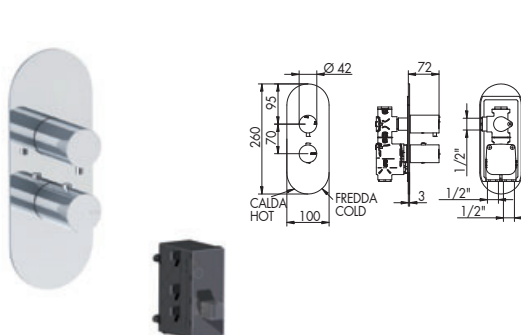

## MISCELATORE TERMOSTATICO INCASSO 1 USCITA

- > cartuccia termostatica
- > vitone ceramico 90°
- > apertura con rotazione antioraria > 2 maniglie
- > interasse 70 mm > ingressi inferiori da 1/2"
- > uscite laterali destra da 1/2" > incasso con B-Box
- > incasso regolabile min 76 > piastra unica

 775007  
p. 220

 055134  
p. 220

## PARTI ESTERNE - CROMATO

01-7312/P/E €

## PARTI ESTERNE - ALTRE FINITURE

XX-7312/P/E € x M\*

## PARTE INCASSO

484020 info pag. 181 €

PREZZO TOTALE €

## 7312/2/P/E + 484021

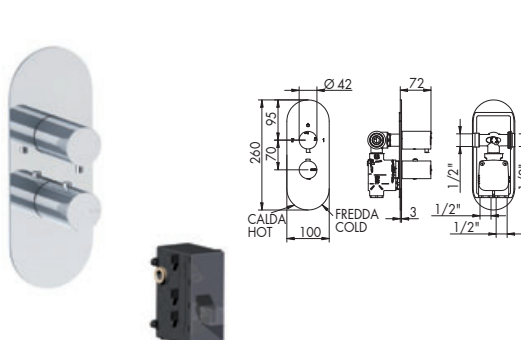

## MISCELATORE TERMOSTATICO INCASSO C/ DEVIATORE 2 USCITE

- > cartuccia termostatica
- > deviatore a dischi ceramici 2 uscite c/chiusura
- > ingressi inferiori da 1/2" > uscite laterali da 1/2"
- > incasso con B-Box > incasso regolabile min 76
- > piastra unica
- > 2 maniglie

 775007  
p. 220

 035346  
p. 212

## PARTI ESTERNE - CROMATO

01-7312/2/P/E €

## PARTI ESTERNE - ALTRE FINITURE

XX-7312/2/P/E € x M\*

## PARTE INCASSO

484021 info pag. 181 €

PREZZO TOTALE €

## 7312/3/P/E + 484022

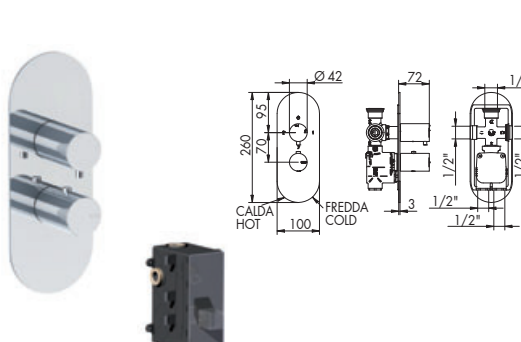

## MISCELATORE TERMOSTATICO INCASSO C/DEVIATORE 3 USCITE

- > cartuccia termostatica
- > deviatore a dischi ceramici 3 uscite c/chiusura
- > interasse 70 mm
- > ingressi inferiori da 1/2" > uscite laterali da 1/2"
- > incasso con B-Box > incasso regolabile min 76
- > piastra unica
- > 2 maniglie

 775007  
p. 220

 035345  
p. 212

## PARTI ESTERNE - CROMATO

01-7312/3/P/E €

## PARTI ESTERNE - ALTRE FINITURE

XX-7312/3/P/E € x M\*

## PARTE INCASSO

484022 info pag. 181 €

PREZZO TOTALE €



## 7312/4/P/E + 484023

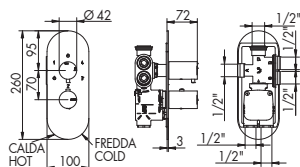

## MISCELATORE TERMOSTATICO INCASSO C/DEVIATORE 4 USCITE

- > cartuccia termostatica
- > deviatore a dischi ceramici 4 uscite c/doppia chiusura
- > interasse 70 mm
- > ingressi inferiori da 1/2" > uscite laterali da 1/2"
- > incasso con B-Box > incasso regolabile min 76
- > piastra unica
- > 2 maniglie



775007

p. 220



035344

p. 212

## PARTI ESTERNE - CROMATO

01-7312/4/P/E €

## PARTI ESTERNE - ALTRE FINITURE

XX-7312/4/P/E € x M\*

## PARTE INCASSO

484023 info pag. 181 €

PREZZO TOTALE €

## 0312/K/E + 484020

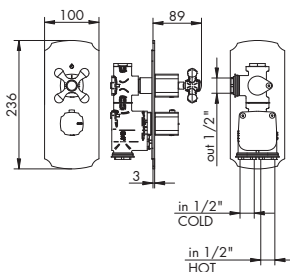

## MISCELATORE TERMOSTATICO INCASSO 1 USCITA

- > cartuccia termostatica
- > vitone ceramico 90°
- > apertura con rotazione antioraria > interasse 70 mm
- > ingressi inferiori da 1/2" > uscite laterali destra da 1/2"
- > incasso con B-Box > incasso regolabile min 76
- > posizionabile orizzontalmente > piastra unica
- > 2 maniglie > attivatore maniglia a croce



775007

p. 220



055134

p. 220

## PARTI ESTERNE - CROMATO

01-0312/K/E €

## PARTI ESTERNE - ALTRE FINITURE

XX-0312/K/E € x M\*

## PARTE INCASSO

484020 info pag. 181 €

PREZZO TOTALE €

## 0312/2/K/E + 484021

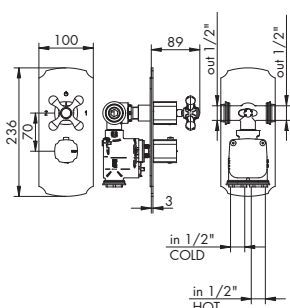

## MISCELATORE TERMOSTATICO INCASSO C/ DEVIATORE 2 USCITE

- > cartuccia termostatica
- > deviatore a dischi ceramici 2 uscite c/chiusura
- > interasse 70 mm
- > ingressi inferiori da 1/2" > uscite laterali da 1/2"
- > incasso con B-Box > incasso regolabile min 76
- > piastra unica > 2 maniglie
- > deviatore maniglia a croce



775007

p. 220



035346

p. 212

## PARTI ESTERNE - CROMATO

01-0312/2/K/E €

## PARTI ESTERNE - ALTRE FINITURE

XX-0312/2/K/E € x M\*

## PARTE INCASSO

484021 info pag. 181 €

PREZZO TOTALE €

## 0312/3/K/E + 484022

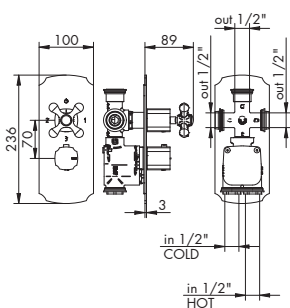

## MISCELATORE TERMOSTATICO INCASSO C/DEVIATORE 3 USCITE

- > cartuccia termostatica
- > deviatore a dischi ceramici 3 uscite c/chiusura
- > interasse 70 mm
- > ingressi inferiori da 1/2" > uscite superiore e laterali da 1/2"
- > incasso con B-Box > incasso regolabile min 76
- > piastra unica > 2 maniglie
- > deviatore maniglia a croce



775007

p. 220



035345

p. 212

## PARTI ESTERNE - CROMATO

01-0312/3/K/E €

## PARTI ESTERNE - ALTRE FINITURE

XX-0312/3/K/E € x M\*

## PARTE INCASSO

484022 info pag. 181 €

PREZZO TOTALE €

## 0312/4/K/E + 484023

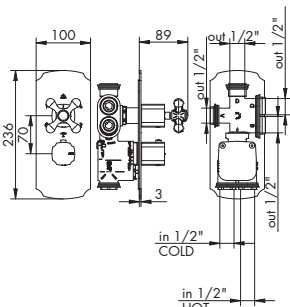

## MISCELATORE TERMOSTATICO INCASSO C/DEVIATORE 4 USCITE

- > cartuccia termostatica
- > deviatore a dischi ceramici 4 uscite c/doppia chiusura
- > interasse 70 mm
- > ingressi inferiori da 1/2" > uscite laterali e superiore da 1/2"
- > incasso con B-Box > incasso regolabile min 76
- > piastra unica classic > 2 maniglie
- > deviatore maniglia a croce



775007

p. 220



035344

p. 212

## PARTI ESTERNE - CROMATO

01-0312/4/K/E €

## PARTI ESTERNE - ALTRE FINITURE

XX-0312/4/K/E € x M\*

## PARTE INCASSO

484023 info pag. 181 €

PREZZO TOTALE €

## RICAMBI IMMEDIATI



CARTUCCIA TERMOSTATICA



VITONE CERAMICO



CARTUCCIA DEVIATRICE

XX = CODICE FINITURA RICHIESTA: per identificare codice corretto vedi pag. 240  
 M\* = MOLTIPLICATORE: per calcolare il prezzo delle altre finiture vedi tabella pag. 240

1412/K/E + 484020

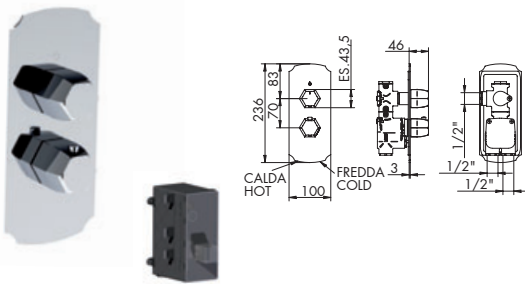

MISCELATORE TERMOSTATICO INCASSO 1 USCITA

- > cartuccia tradizionale
- > vitone ceramico 90°
- > apertura con rotazione antioraria
- > ingressi inferiori da 1/2"
- > incasso con B-Box
- > piastra unica
- > interasse 70 mm
- > uscita laterale destra da 1/2"
- > incasso regolabile min 76
- > 2 maniglie

 **775007**  
p. 220

 **055134**  
p. 220

PARTI ESTERNE - CROMATO		PARTI ESTERNE - ALTRE FINITURE	
01-1412/K/E	€	XX-1412/K/E	€ x M*
<b>PARTE INCASSO</b>			
484020	info pag. 181	€	
<b>PREZZO TOTALE</b>		€	

1612/K/E + 484020 | SUITE

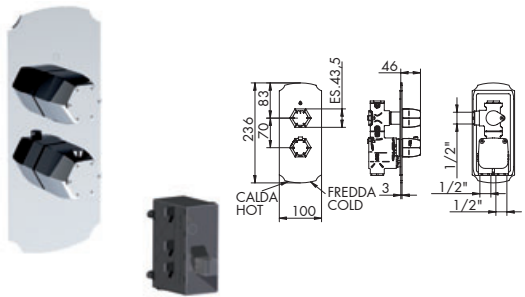

MISCELATORE TERMOSTATICO INCASSO 1 USCITA C/SWAROVSKI

- > cartuccia tradizionale
- > vitone ceramico 90°
- > apertura con rotazione antioraria
- > interasse 70 mm
- > ingressi inferiori da 1/2"
- > incasso con B-Box
- > piastra unica
- > uscita laterale destra da 1/2"
- > incasso regolabile min 76
- > 2 maniglie con SWAROVSKI

 **775007**  
p. 220

 **055134**  
p. 220

PARTI ESTERNE - CROMATO		PARTI ESTERNE - ALTRE FINITURE	
01-1612/K/E	€	XX-1612/K/E	€ x M*
<b>PARTE INCASSO</b>			
484020	info pag. 181	€	
<b>PREZZO TOTALE</b>		€	

1712/K/E + 484020

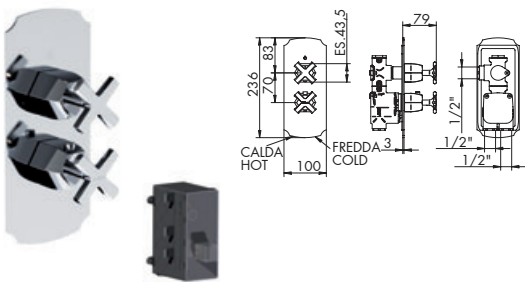

MISCELATORE TERMOSTATICO INCASSO 1 USCITA

- > cartuccia tradizionale
- > vitone ceramico 90°
- > apertura con rotazione antioraria
- > ingressi inferiori da 1/2"
- > incasso con B-Box
- > piastra unica
- > interasse 70 mm
- > uscita laterale destra da 1/2"
- > incasso regolabile min 76
- > 2 maniglie a croce

 **775007**  
p. 220

 **055134**  
p. 220

PARTI ESTERNE - CROMATO		PARTI ESTERNE - ALTRE FINITURE	
01-1712/K/E	€	XX-1712/K/E	€ x M*
<b>PARTE INCASSO</b>			
484020	info pag. 181	€	
<b>PREZZO TOTALE</b>		€	

1812/K/E + 484020 | SUITE

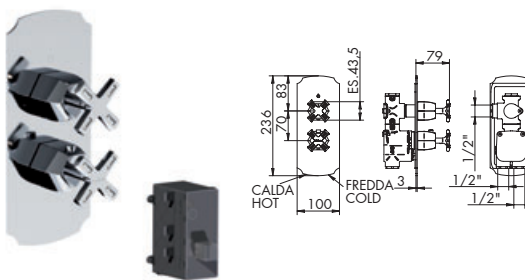

MISCELATORE TERMOSTATICO INCASSO 1 USCITA C/SWAROVSKI

- > cartuccia tradizionale
- > vitone ceramico 90°
- > apertura con rotazione antioraria
- > interasse 70 mm
- > ingressi inferiori da 1/2"
- > incasso con B-Box
- > piastra unica
- > uscita laterale destra da 1/2"
- > incasso regolabile min 76
- > 2 maniglie a croce con SWAROVSKI

 **775007**  
p. 220

 **055134**  
p. 220

PARTI ESTERNE - CROMATO		PARTI ESTERNE - ALTRE FINITURE	
01-1812/K/E	€	XX-1812/K/E	€ x M*
<b>PARTE INCASSO</b>			
484020	info pag. 181	€	
<b>PREZZO TOTALE</b>		€	

1412/2K/E + 484021

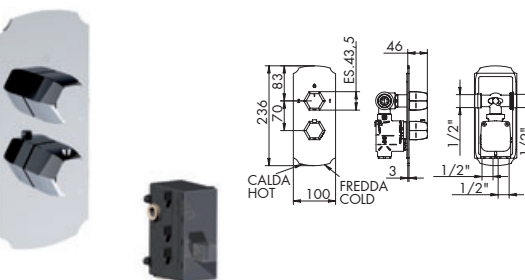

MISCELATORE TERMOSTATICO INCASSO C/ DEVIATORE 2 USCITE

- > cartuccia termostatica
- > deviatore a dischi ceramici 2 uscite c/chiusura
- > interasse 70 mm
- > ingressi inferiori da 1/2"
- > incasso con B-Box
- > piastra unica
- > uscite laterali da 1/2"
- > incasso regolabile min 76
- > 2 maniglie

 **775007**  
p. 220

 **035346**  
p. 212

PARTI ESTERNE - CROMATO		PARTI ESTERNE - ALTRE FINITURE	
01-1412/2K/E	€	XX-1412/2K/E	€ x M*
<b>PARTE INCASSO</b>			
484021	info pag. 181	€	
<b>PREZZO TOTALE</b>		€	



## 1612/2K/E + 484021 | SUITE

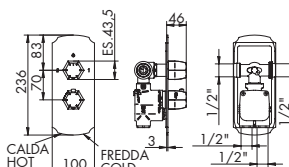

## MISCELATORE TERMOSTATICO INCASSO C/ DEVIATORE 2 USCITE C/SWAROVSKI

- > cartuccia termostatica
- > deviatore a dischi ceramici 2 uscite c/chiusura
- > interasse 70 mm
- > ingressi inferiori da 1/2"
- > incasso con B-Box
- > piastra unica
- > uscite laterali da 1/2"
- > incasso regolabile min 76
- > 2 maniglie con SWAROVSKI

775007  
p. 220035346  
p. 212

## PARTI ESTERNE - CROMATO

01-1612/2K/E €

## PARTI ESTERNE - ALTRE FINITURE

XX-1612/2K/E € x M\*

## PARTE INCASSO

484021 info pag. 181 €

PREZZO TOTALE €

## 1712/2K/E + 484021

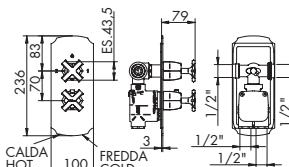

## MISCELATORE TERMOSTATICO INCASSO C/ DEVIATORE 2 USCITE

- > cartuccia termostatica
- > deviatore a dischi ceramici 2 uscite c/chiusura
- > interasse 70 mm
- > ingressi inferiori da 1/2"
- > incasso con B-Box
- > piastra unica
- > uscite laterali da 1/2"
- > incasso regolabile min 76
- > 2 maniglie a croce

775007  
p. 220035346  
p. 212

## PARTI ESTERNE - CROMATO

01-1712/2K/E €

## PARTI ESTERNE - ALTRE FINITURE

XX-1712/2K/E € x M\*

## PARTE INCASSO

484021 info pag. 181 €

PREZZO TOTALE €

## 1812/2K/E + 484021 | SUITE

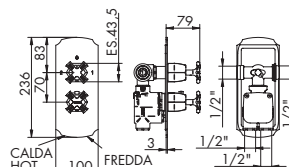

## MISCELATORE TERMOSTATICO INCASSO C/ DEVIATORE 2 USCITE C/SWAROVSKI

- > cartuccia termostatica
- > deviatore a dischi ceramici 2 uscite c/chiusura
- > interasse 70 mm
- > ingressi inferiori da 1/2"
- > incasso con B-Box
- > piastra unica
- > uscite laterali da 1/2"
- > incasso regolabile min 76
- > 2 maniglie a croce con SWAROVSKI

775007  
p. 220035346  
p. 212

## PARTI ESTERNE - CROMATO

01-1812/2K/E €

## PARTI ESTERNE - ALTRE FINITURE

XX-1812/2K/E € x M\*

## PARTE INCASSO

484021 info pag. 181 €

PREZZO TOTALE €

## 1412/3K/E + 484022

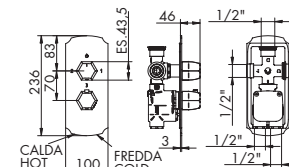

## MISCELATORE TERMOSTATICO INCASSO C/DEVIATORE 3 USCITE

- > cartuccia termostatica
- > deviatore a dischi ceramici 3 uscite c/chiusura
- > interasse 70 mm
- > ingressi inferiori da 1/2"
- > incasso con B-Box
- > piastra unica
- > uscite laterali e superiore da 1/2"
- > incasso regolabile min 76
- > 2 maniglie

775007  
p. 220035345  
p. 212

## PARTI ESTERNE - CROMATO

01-1412/3K/E €

## PARTI ESTERNE - ALTRE FINITURE

XX-1412/3K/E € x M\*

## PARTE INCASSO REMOTO

484022 info pag. 181 €

PREZZO TOTALE €

## 1612/3K/E + 484022 | SUITE

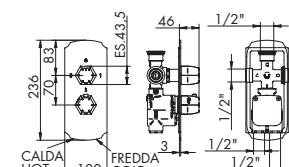

## MISCELATORE TERMOSTATICO INCASSO C/DEVIATORE 3 USCITE C/SWAROVSKI

- > cartuccia termostatica
- > deviatore a dischi ceramici 3 uscite c/chiusura
- > interasse 70 mm
- > ingressi inferiori da 1/2"
- > incasso con B-Box
- > piastra unica
- > uscite laterali e superiore da 1/2"
- > incasso regolabile min 76
- > 2 maniglie con SWAROVSKI

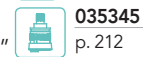
775007  
p. 220035345  
p. 212

## PARTI ESTERNE - CROMATO

01-1612/3K/E €

## PARTI ESTERNE - ALTRE FINITURE

XX-1612/3K/E € x M\*

## PARTE INCASSO

484022 info pag. 181 €

PREZZO TOTALE €

## RICAMBI IMMEDIATI

CARTUCCIA  
TERMOSTATICACARTUCCIA  
DEVIATRICE

XX = CODICE FINITURA RICHIESTA: per identificare codice corretto vedi pag. 240  
M\* = MOLTIPLICATORE: per calcolare il prezzo delle altre finiture vedi tabella pag. 240





## 1812/4K/E + 484023 | SUITE

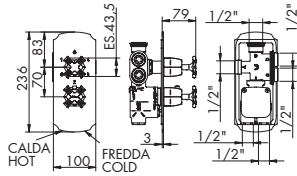

## MISCELATORE TERMOSTATICO INCASSO C/DEVIATORE 4 USCITE C/SWAROVSKI

- > cartuccia termostatica
- > deviatore a dischi ceramici 4 uscite c/doppia chiusura
- > interasse 70 mm
- > ingressi inferiori da 1/2"
- > incasso con B-Box
- > piastra unica
- > uscite laterali e superiore da 1/2"
- > incasso regolabile min 76
- > 2 maniglie a croce con SWAROVSKI

**775007**  
p. 220

**035344**  
p. 212

## PARTI ESTERNE - CROMATO

01-1812/4K/E €

## PARTI ESTERNE - ALTRE FINITURE

XX-1812/4K/E € x M\*

## PARTE INCASSO

484023 info pag. 181 €

PREZZO TOTALE €



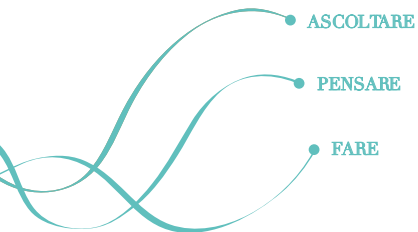

● ASCOLTARE

● PENSARE

● FARE

ASCOLTARE, PENSARE, FARE è la formula che abbiamo scelto per descrivere l'attenzione con cui interpretiamo i desideri del cliente, elaboriamo soluzioni ed esprimiamo proposte che ne soddisfino i gusti e le esigenze. Con lo stesso spirito, con lo stesso entusiasmo, oggi come oltre cinquantasei anni fa.

LISTEN, THINK, ACT is the philosophy that we use to describe the attention by which we interpret the wishing of the client, we find solution and make proposal for meet the taste and exigent. With the same mind and passion, today like more than fifty-six years ago.

---

© 2017 Bellosta Rubinetterie. Tutti i diritti riservati.

GRAPHIC:  
Roberta Teruggi

CONCEPT:  
aCB

---

BELLOSTA CARLO & C. RUBINETTERIE Srl  
Via S. Botticelli, 12/14 | 28024 Briga Novarese (No) Italia  
Ingresso showroom: Largo Carlo Bellosta | Briga Novarese (No) Italia  
Atelier Milano: Via Montenapoleone, 22  
Atelier Roma: Piazza di Spagna, ingresso Via Gregoriana 23

T +39 0322 956 425 | 0322 912 330 | 0322 946 84  
F +39 0322 955 368 | info@bellostarubinetterie.com  
Export department: estero@bellostarubinetterie.com

Bellosta Rubinetterie is available on **App Store**  
Follow us on facebook, you tube, linked in, twitter, pinterest, instagram, houzz

