



INDICE / INDEX	pag. 600
<u>B-TRONIC</u>	pag. 605
TABELLA PREZZI FINITURE B-TRONIC	pag. 603
INFO TECNICHE B-TRONIC	pag. 603
<u>HYDROSCOPINI</u>	pag. 608
<u>HYDROMIX</u>	pag. 611
<u>PIASTRE PER CASSETTA WC</u>	pag. 612
<u>BORDO V-BOX</u>	pag. 615
TABELLA PREZZI FINITURE HYDROSCOPINI   HYDROMIX   PIASTRE PER CASSETTA WC   BORDO V-BOX	pag. 606
INFO TECNICHE HYDROSCOPINI E HYDROMIX	pag. 607
INFO TECNICHE BORDO V-BOX	pag. 614

**B-TRONIC - RUBINETTI ELETTRONICI**



**0405/S/EL | BAMBU'** pag. 605

MISCELATORE CON ATTIVATORE INFRAROSSO  
LAVABO  
BASIN MIXER WITH INFRARED ACTIVATOR



**8305/S/EL | FUNTANIN BIJOUX** pag. 605

MISCELATORE CON ATTIVATORE INFRAROSSO  
LAVABO CON SWAROVSKI  
BASIN MIXER WITH INFRARED ACTIVATOR WITH  
SWAROVSKI



**8105/S/EL | FUNTANIN** pag. 605

MISCELATORE CON ATTIVATORE INFRAROSSO  
LAVABO  
BASIN MIXER WITH INFRARED ACTIVATOR



**7505/N/S/EL | ZEHN** pag. 605

MISCELATORE CON ATTIVATORE INFRAROSSO  
LAVABO  
BASIN MIXER WITH INFRARED ACTIVATOR



**0805/4/S/EL | EDWARD** pag. 605

MISCELATORE CON ATTIVATORE INFRAROSSO  
LAVABO  
BASIN MIXER WITH INFRARED ACTIVATOR

**HYDROSCOPINI**



**0403/ID/1** pag. 608

IDROSCOPINO TONDO LASER  
ROUND HYDROBRUSH WITH LASER ACTIVATOR



**0403/ID** pag. 608

IDROSCOPINO TONDO SPRAY  
ROUND HYDROBRUSH WITH SPRAY ACTIVATOR



**0403/ID/LA** pag. 608

IDROSCOPINO TONDO LASER MINI  
"MINI" ROUND HYDROBRUSH WITH LASER  
ACTIVATOR



**0903/ID/1** pag. 608

IDROSCOPINO TONDO LASER  
ROUND HYDROBRUSH WITH LASER ACTIVATOR



**0903/ID** pag. 608

IDROSCOPINO TONDO SPRAY  
ROUND HYDROBRUSH WITH SPRAY ACTIVATOR



**0903/ID/LA** pag. 609

IDROSCOPINO TONDO LASER MINI  
"MINI" ROUND HYDROBRUSH WITH LASER  
ACTIVATOR



**7503/ID/1** pag. 609

IDROSCOPINO QUADRO LASER  
SQUARE HYDROBRUSH WITH LASER ACTIVATOR



**7503/ID** pag. 609

IDROSCOPINO QUADRO SPRAY  
SQUARE HYDROBRUSH WITH SPRAY ACTIVATOR



**3303/ID/1** pag. 609

IDROSCOPINO QUADRO LASER CON SWAROVSKI  
SQUARE HYDROBRUSH WITH LASER ACTIVATOR  
AND SWAROVSKI



**3303/ID** pag. 609

IDROSCOPINO QUADRO SPRAY CON SWAROVSKI  
SQUARE HYDROBRUSH WITH SPRAY ACTIVATOR  
AND SWAROVSKI

**HYDROSCOPINI**



**0303/ID/1** pag. 610  
 IDROSCOPINO CLASSIC LASER  
 CLASSIC HYDROBRUSH WITH LASER ACTIVATOR



**0303/ID** pag. 610  
 IDROSCOPINO CLASSIC SPRAY  
 CLASSIC HYDROBRUSH WITH SPRAY ACTIVATOR



**0303/ID/LA** pag. 610  
 IDROSCOPINO CLASSIC LASER MINI  
 "MINI" CLASSIC HYDROBRUSH WITH LASER ACTIVATOR



**1403/ID/1** pag. 610  
 IDROSCOPINO TONDO ROSONE CLASSIC LASER  
 ROUND HYDROBRUSH WITH LASER ACTIVATOR



**1403/ID** pag. 610  
 IDROSCOPINO TONDO ROSONE CLASSIC SPRAY  
 ROUND HYDROBRUSH WITH SPRAY ACTIVATOR



**4503/ID** pag. 611  
 IDROSCOPINO COMPLETO  
 HYDROBRUSH

**HYDROMIX**



**0403/MI/E + 034134** pag. 611  
 IDROMISCELATORE TONDO  
 ROUND IDRO MIXER

parti esterne / external parts: 0403/MI/E  
 parte incasso / built-in part: 034134



**7503/MI/E + 034134** pag. 611  
 IDROMISCELATORE QUADRO  
 SQUARE IDRO MIXER

parti esterne / external parts: 7503/MI/E  
 parte incasso / built-in part: 034134



**0303/MI/E + 034134** pag. 611  
 IDROMISCELATORE CLASSIC  
 CLASSIC IDRO MIXER

parti esterne / external parts: 0303/MI/E  
 parte incasso / built-in part: 034134



**1403/MI/E + 034134** pag. 611  
 IDROMISCELATORE TONDO ROSONE CLASSIC  
 CLASSIC IDRO MIXER

parti esterne / external parts: 1403/MI/E  
 parte incasso / built-in part: 034134

**PIASTRE PER CASSETTA WC**



**018/5+** pag. 612  
 PIASTRA PER CASSETTA WC  
 PLATE FOR WASTE SYSTEM



**018/4** pag. 612  
 PIASTRA PER CASSETTA WC  
 PLATE FOR WASTE SYSTEM



**018/2** pag. 612  
 PIASTRA PER CASSETTA WC  
 PLATE FOR WASTE SYSTEM



**018/6+** pag. 612  
 PIASTRA PER CASSETTA WC  
 PLATE FOR WASTE SYSTEM



**018/3** pag. 612  
 PIASTRA PER CASSETTA WC  
 PLATE FOR WASTE SYSTEM



**018/7X** pag. 613  
 PIASTRA PER CASSETTA WC  
 PLATE FOR WASTE SYSTEM

**BORDO V-BOX****012/3** pag. **615****PIASTRA PER BORDO VASCA TRE FORI**  
**PLATE FOR 3 HOLE BATH RIM****012/4** pag. **615****PIASTRA PER BORDO VASCA QUATTRO FORI**  
**PLATE FOR 4 HOLE BATH RIM****012/5** pag. **615****PIASTRA PER BORDO VASCA CINQUE FORI**  
**PLATE FOR 5 HOLE BATH RIM****012/6** pag. **615****PREDISPOSIZIONE PER PIASTRA BORDO VASCA**  
**PRE-INSTALLATION SYSTEM FOR PLATE BATH RIM****012/7** pag. **615****VASCHETTA PER PREDISPOSIZIONE BORDO VASCA**  
**CASE FOR PRE-INSTALLATION SYSTEM FOR PLATE**  
**BATH RIM**

**PREZZO FINITURE**

Calcola il prezzo di listino (IVA esclusa) delle finiture diverse dal cromato, consultando la seguente tabella.

Moltiplicare il **PREZZO LISTINO** per il **COEFFICIENTE MOLTIPLICATORE** della finitura scelta, arrotondando per difetto il prezzo ottenuto (eliminare i centesimi).

ESEMPIO per ordinare art. 0405/S/EL in finitura dorato: codice 04-0405/S/EL

**PRICE FINISHES**

Include the list price (excluding VAT) of different finishes from chrome, consulting the following table. **Multiply the PRICE LIST COEFFICIENT MULTIPLIER** of the chosen finish, reducing the price obtained by deleting the centesim.

EXAMPLE to order art. 0405/S/EL gold finish: code 04-0405/S/EL

**COMPOSIZIONE CODICE PER ORDINARE ARTICOLO IN FINITURA**

**XX** - **0405/S/EL**

**CODICE FINITURA**      **CODICE ARTICOLO**  
**FINISH CODE**            **ITEM NUMBER**

**FINITURE REALIZZABILI / MADE FINISHES**

CODICE CODE	DESCRIZIONE FINITURA FINISH DESCRIPTION	BAMBU'	FUNTAMIN F-BLOUX	ZEHN	EDWARD
01-	cromato / chrome	P.L.	P.L.	P.L.	P.L.
02-	cromo/oro / chrome/gold	x	x	x	x
03-	oro/argento / gold/silver	x	x	x	x
04-	dorato / gold	x	x	x	x
05-	bronzo satinato / satin bronze	x	x	x	x
06-	rame vecchio / old copper	x	x	x	x
07-	vecchio argento / old silver	x	N.R.	x	x
08-	canna di fucile / gun barrel	x	N.R.	x	x
10-	verderame / verdigris	x	N.R.	x	x
11-	nero antracite / anthracite black	x	N.R.	x	x
12-	ottone lucido / polished brass	x	N.R.	x	x
13-	ottone naturale / natural brass	x	x	x	x
14-	bianco / white	x	N.R.	x	x
19-	nero / black	x	N.R.	x	x
28-	nickel satinato / satin nickel	x	x	x	x
30-	nickel lucido / polished nickel	x	N.R.	x	x
33-	cromo satinato / satin chrome	x	x	x	x

**FINITURE REALIZZABILI / MADE FINISHES**

CODICE CODE	DESCRIZIONE FINITURA FINISH DESCRIPTION	BAMBU'	FUNTAMIN F-BLOUX	ZEHN	EDWARD
34-	cromo spazzolato / brushing chrome	x	x	x	x
35-	nickel spazzolato / brushing nickel	x	x	x	x
56-	avorio / ivory	x	N.R.	x	x
57-	azzurro / light blue	x	N.R.	x	x
58-	verdino / light green	x	N.R.	x	x
59-	marrone / brown	x	N.R.	x	x
60-	arancio / orange	x	N.R.	x	x
61-	rosso / red	x	N.R.	x	x
66-	bianco opaco / mat white	x	x	x	x
67-	nero opaco / mat black	x	x	x	x
68-	rame opaco / mat copper	x	x	x	x
69-	argento opaco / mat silver	x	x	x	x
71-	oro opaco / mat gold	x	N.R.	x	x
72-	bronzo opaco / mat bronze	x	N.R.	x	x
75-	dorato spazzolato / brushing gold	x	N.R.	x	x
87-	oro rosa / pink gold	x	x	x	x
88-	ottone sisal / sisal brass	x	x	x	x

P.L. = PREZZO DI LISTINO / PRICE LIST  
N.R. = NON REALIZZABILE / NOT MADE

**MOLTIPLICATORE ROSSO** = FINITURE DI SERIE  
**RED MULTIPLIER** = STANDARD FINISHES

**MOLTIPLICATORE NERO** = FINITURE A RICHIESTA  
**BLACK MULTIPLIER** = ON REQUEST FINISHES

**ATTENZIONE! 13-OTTONE NATURALE e 88-OTTONE SISAL: finiture non protette che antichizzano naturalmente ossidando a contatto con l'umidità atmosferica.**  
**WARNING! 13-NATURAL BRASS and 88-SISAL BRASS: unprotected finishes that naturally oxidise in contact with atmospheric humidity.**

**PROGETTO SU MISURA: RICHIESTE SPECIALI**

I tecnici di Bellosta Rubinetterie sono, inoltre, a disposizione di architetti e designers, per offrire un servizio esclusivo: personalizzazioni di elementi in funzione di specifiche richieste estetiche o problematiche legate a vincoli progettuali, verifica della fattibilità attraverso opportuni studi CAD e sviluppo del disegno tecnico del prodotto speciale richiesto.  
Per informazioni e richieste PROGETTI SU MISURA: [ufficiotecnico@bellostarubinetterie.com](mailto:ufficiotecnico@bellostarubinetterie.com)



**PROGETTO SU MISURA: SPECIAL REQUESTS**

Engineers Bellosta Rubinetterie are also available to architects and designers, to offer an exclusive service: customizations of items according to specific aesthetic requirements or issues related to design constraints, verification of the feasibility studies and development through appropriate CAD technical design the required special product. For information and requests "SU MISURA" PROJECTS: [ufficiotecnico@bellostarubinetterie.com](mailto:ufficiotecnico@bellostarubinetterie.com)

**LEGENDA SIMBOLI**

**ACCESSORI**  
**ACCESSORIES**

SCARICO C/TAPPO A PRESSIONE  
WASTE WITH PRESSURE CAP

**RICAMBI IMMEDIATI**  
**IMMEDIATE PARTS**

CARTUCCIA CARTRIDGE  
 CARTUCCIA DEVIATRICE DIVERTER CARTRIDGE

CARTUCCIA TERMOSTATICA THERMOSTATIC CARTRIDGE  
 DEVIATORE DIVERTER

VITONE CERAMICO CERAMIC VALVE  
 AERATORE TONDO ROUND AERATOR

VITONE TRADIZIONALE TRADITIONAL VALVE  
 AERATORE PIATTO FLAT AERATOR

B TRONIC: ELETTRONICA AD ALTA TECNOLOGIA

B TRONIC: HIGH TECHNOLOGY ELECTRONIC

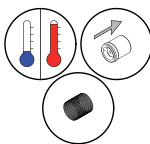

1) Gruppo elettrovalvola con regolazione della temperatura, valvole di non ritorno e filtri incorporati.  
1) Electro valve group with temperature regulator, no come back valve and built-in filters.



2) Gruppo batterie al litio incluse.  
2) Lithium group batteries included.



3) Trasformatore di rete per alimentazione rete fissa opzionale.  
3) Transformer for power supply optional.



4) Gruppo infrarossi programmabile con powersaving (alla accensione il sistema chiude la valvola e verifica lo stato di accendimento o meno del sensore):

A\_ Sensore non e' accecato (alimentazione da trasformatore) il sistema esegue i seguenti parametri:

- tempo di check (frequenza d'impulso): 6 impulsi al secondo
- antivandalò: 20s (tempo di costante permanenza accendimento)
- comfort time: 10s (tempo di ritardo chiusura valvola dall'ultimo rilascio di accendimento).

B\_ Sensore e' accecato (alimentazione da batteria/powersaving) il sistema mostra a mezzo della accensione di un led il riconoscimento di tale richiesta ed in seguito esegue i seguenti parametri:

- tempo di check 1: 6 impulsi al secondo, per un tempo massimo di circa 1h30, successivamente interviene check 2.

- tempo di check 2: 3 impulsi al secondo, si torna al check1 alla prima verifica accendimento. check2 e' lo stato di risparmio energetico.

- antivandalò: 20s (tempo di costante permanenza accendimento)
- comfort time: 10s (tempo di ritardo chiusura valvola dall'ultimo rilascio di accendimento).

4) IR group program by powersaving (at start the system close the valve and verify the counter sinked or not of the sense):

A\_ The sense is not counter sinked (supply by transformer) the system makes these parameters:

- check time (impulse frequency): 6 impulses at second
- no vandal proof: 20s (steady time of counter sinked)
- comfort time: 10s (delay time of closed valve from the last time of counter sinked).

B\_ The sense is counter sinked (supply by battery/powersaving) the system shows by led ignition this request and then makes these parameters:

- time check 1: 6 impulses for a maximum time of 1h30, then goes to check 2

- time check 2: 3 impulses, come back to check 1 at the first verify of counter sinked. Check 2 is the mode of energy saving

- no vandal proof: 20s (steady time of counter sinked)
- comfort time: 10s (delay time of closed valve from the last time of counter sinked).



5) Compensazione algoritmica di risposta sensore alla repentina variazione di temperatura locale.  
5) Algorithm compensation of sense reply of the local temperature variation.



6) Protezione alla inversione di polarità delle batterie.  
6) Care for the reversing polarity of batteries.



7) Protezione al cortocircuito driver valvola.  
7) Care for the short circuit of driver valve.



8) Quando le batterie devono essere sostituite la valvola si blocca in modalità chiusa. Ad ogni successiva richiesta utente il LED interno al sensore lampeggerà velocemente senza che la valvola venga più aperta fino al cambio batterie.

8) When the batteries have to be supplanted, the valve is on closed way. From now at new request from anyone the internal LED sense will flash quickly free till the valve it will be open till the battery change.



9) Distanza di sensing lineare: 100mm +/- 20mm.  
9) Distance sensing line: 100mm +/- 20mm.



10) Sensing a 100mm: -1.8mm + 1.8mm.  
10) Sensing a 100mm: -1.8mm + 1.8mm.



11) Temperatura operativa: da un minimo di -10C ad un massimo di +60C.  
11) Operator temperature: from less -10C than max +60C.



12) Sensore adatto a qualunque condizione d'illuminamento artificiale e/o naturale.  
12) Useful sense for any light natural or not condition.

Prodotti elettronici certificati  
Electronic products certified



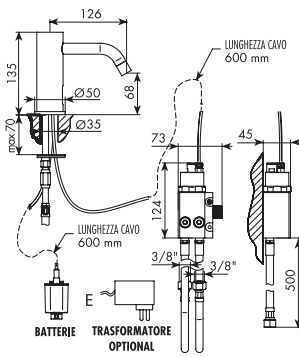

0405/S/EL | BAMBU'



MISCELATORE CON ATTIVATORE INFRAROSSO LAVABO

- > attivatore ad infrarosso con campo di azione da 80 a 120mm
- > interasse bocca 126
- > impostazione temperatura manuale
- > gruppo elettrovalvole incluso
- > pacchetto batterie incluso
- > gestione con trasformatore per corrente opzionale
- > flessibili di alimentazione
- > senza scarico

 **0136 - 0136/1**  
p. 717

 **014073**  
p. 140

CROMATO	€	ALTRE FINITURE	€	x M*
01-0405/S/EL	€	XX-0405/S/EL	€	x M*

8305/S/EL | FUNTANIN BIJOUX

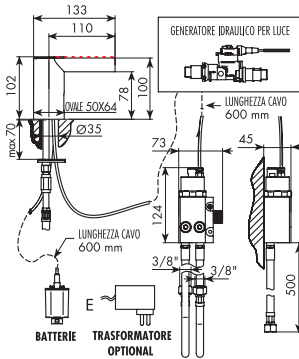

MISCELATORE CON ATTIVATORE INFRAROSSO LAVABO C/SWAROVSKI

- > attivatore ad infrarosso con campo di azione da 80 a 120mm
- > interasse bocca 110
- > impostazione temperatura manuale
- > gruppo elettrovalvole incluso
- > pacchetto batterie incluso
- > gestione con trasformatore per corrente opzionale
- > luce a LED incorporata con variazione in base alla temperatura
- > uscita libera senza areatore
- > flessibili di alimentazione
- > senza scarico

 **8336 - 8336/1**  
p. 724

CROMATO	€	ALTRE FINITURE	€	x M*
01-8305/S/EL	€	XX-8305/S/EL	€	x M*

8105/S/EL | FUNTANIN

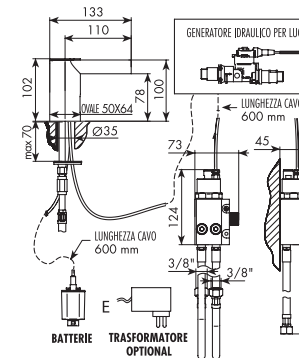

MISCELATORE CON ATTIVATORE INFRAROSSO LAVABO

- > attivatore ad infrarosso con campo di azione da 80 a 120mm
- > interasse bocca 110
- > impostazione temperatura manuale
- > gruppo elettrovalvole incluso
- > pacchetto batterie incluso
- > gestione con trasformatore per corrente opzionale
- > luce a LED incorporata con variazione in base alla temperatura
- > uscita libera senza areatore
- > flessibili di alimentazione
- > senza scarico

 **8036 - 8036/1**  
p. 723

CROMATO	€	ALTRE FINITURE	€	x M*
01-8105/S/EL	€	XX-8105/S/EL	€	x M*

7505/N/S/EL | ZEHN

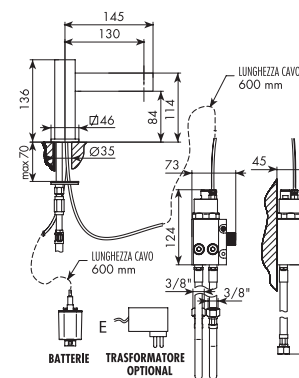

MISCELATORE CON ATTIVATORE INFRAROSSO LAVABO

- > attivatore ad infrarosso con campo di azione da 80 a 120mm
- > interasse bocca 130
- > impostazione temperatura manuale
- > Gruppo elettrovalvole incluso
- > pacchetto batterie incluso
- > gestione con trasformatore per corrente opzionale
- > flessibili di alimentazione
- > senza scarico

 **6536 - 6536/1**  
p. 720

 **795004**  
p. 142

CROMATO	€	ALTRE FINITURE	€	x M*
01-7505/N/S/EL	€	XX-7505/N/S/EL	€	x M*

0805/4/S/EL | EDWARD

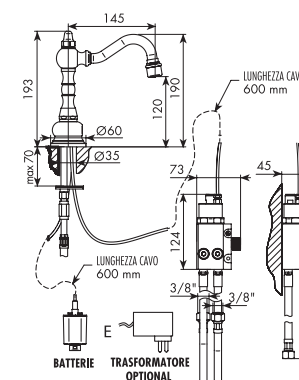

MISCELATORE CON ATTIVATORE INFRAROSSO LAVABO

- > attivatore ad infrarosso con campo di azione da 80 a 120mm
- > interasse bocca 130
- > impostazione temperatura manuale
- > gruppo elettrovalvole incluso
- > pacchetto batterie incluso
- > gestione con trasformatore per corrente opzionale
- > flessibili di alimentazione
- > senza scarico

 **0136 - 0136/1**  
p. 717

 **034013**  
p. 140

CROMATO	€	ALTRE FINITURE	€	x M*
01-0805/4/S/EL	€	XX-0805/4/S/EL	€	x M*



**PREZZO FINITURE**

Calcola il prezzo di listino (IVA esclusa) delle finiture diverse dal cromato, consultando la seguente tabella.

Moltiplicare il **PREZZO LISTINO** per il **COEFFICIENTE MOLTIPLICATORE** della finitura scelta, arrotondando per difetto il prezzo ottenuto (eliminare i centesimi).  
**ESEMPIO** per ordinare art. 0403/ID/1 in finitura dorato: codice 04-0403/ID/1

**PRICE FINISHES**

Include the list price (excluding VAT) of different finishes from chrome, consulting the following table. Multiply the **PRICE LIST MULTIPLIER COEFFICIENT** of the chosen finish, reducing the price obtained by deleting the centesim.

**EXAMPLE** to order art. 0403/ID/1 gold finish: code 04-0403/ID/1

**COMPOSIZIONE CODICE PER ORDINARE ARTICOLO IN FINITURA**

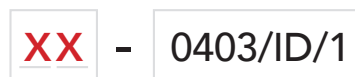

**CODICE FINITURA** / **FINISH CODE**      **CODICE ARTICOLO** / **ITEM NUMBER**

**FINITURE REALIZZABILI / MADE FINISHES**

CODICE CODE	DESCRIZIONE FINITURA FINISH DESCRIPTION	MOLTIPLICATORE MULTIPLIER
01-	cromato / chrome	<b>PREZZO LISTINO°</b>
02-	cromo/oro / chrome/gold	x
03-	oro/argento / gold/silver	x
04-	dorato / gold	x
05-	bronzo satinato / satin bronze	x
06-	rame vecchio / old copper	x
07-	vecchio argento / old silver	x
08-	canna di fucile / gun barrel	x
10-	verderame / verdigris	x
11-	nero antracite / anthracite black	x
12-	ottone lucido / polished brass	x
13-	ottone naturale / natural brass	x
14-	bianco / white	x
19-	nero / black	x
28-	nickel satinato / satin nickel	x
30-	nickel lucido / polished nickel	x
33-	cromo satinato / satin chrome	x

**FINITURE REALIZZABILI / MADE FINISHES**

CODICE CODE	DESCRIZIONE FINITURA FINISH DESCRIPTION	MOLTIPLICATORE MULTIPLIER
34-	cromo spazzolato / brushing chrome	x
35-	nickel spazzolato / brushing nickel	x
56-	avorio / ivory	x
57-	azzurro / light blue	x
58-	verdino / light green	x
59-	marrone / brown	x
60-	arancio / orange	x
61-	rosso / red	x
66-	bianco opaco / mat white	x
67-	nero opaco / mat black	x
68-	rame opaco / mat copper	x
69-	argento opaco / mat silver	x
71-	oro opaco / mat gold	x
72-	bronzo opaco / mat bronze	x
75-	dorato spazzolato / brushing gold	x
87-	oro rosa / pink gold	x
88-	ottone sisal / sisal brass	x

°PREZZO DI LISTINO / PRICE LIST

\*NON REALIZZABILE / NOT MADE

**ATTENZIONE! 13-OTTONE NATURALE e 88-OTTONE SISAL: finiture non protette che antichizzano naturalmente ossidando a contatto con l'umidità atmosferica.**  
**WARNING! 13-NATURAL BRASS and 88-SISAL BRASS: unprotected finishes that naturally oxidise in contact with atmospheric humidity.**

**TABELLA VALIDA PER HYDROSCOPINI, HYDROMIX, PIASTRE PER CASSETTA WC, BORDO V-BOX**

**NOTE:**

0403/ID/LA  
 0903/ID/LA  
 0303/ID/LA

QUESTI ARTICOLI SONO REALIZZABILI SOLO NELLA FINITURA CROMATO

012/6  
 012/7

QUESTI ARTICOLI SONO IN ACCIAIO SENZA FINITURA

**PROGETTO SU MISURA: RICHIESTE SPECIALI**

I tecnici di Bellosta Rubinetterie sono, inoltre, a disposizione di architetti e designers, per offrire un servizio esclusivo: personalizzazioni di elementi in funzione di specifiche richieste estetiche o problematiche legate a vincoli progettuali, verifica della fattibilità attraverso opportuni studi CAD e sviluppo del disegno tecnico del prodotto speciale richiesto.

Per informazioni e richieste PROGETTI SU MISURA:  
 ufficiotecnico@bellostarubinetterie.com

**PROGETTO SU MISURA: SPECIAL REQUESTS**

Engineers Bellosta Rubinetterie are also available to architects and designers, to offer an exclusive service: customizations of items according to specific aesthetic requirements or issues related to design constraints, verification of the feasibility studies and development through appropriate CAD technical design the required special product. For information and requests "SU MISURA" PROJECTS:  
 ufficiotecnico@bellostarubinetterie.com



CONSIGLIO TECNICO:

POSIZIONARE L'IDROSCOPINO AD UNA ALTEZZA DI 500-700 MM DA PAVIMENTO

TECHNICAL ADVICE:

IT WILL BE BETTER TO PUT THE HYDROBRUSH AT 500-700 MM FROM THE FLOOR

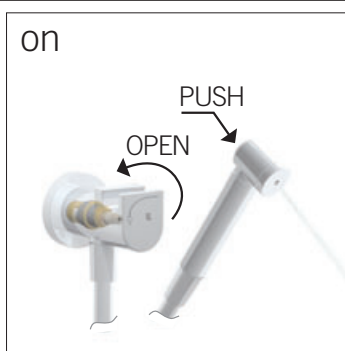
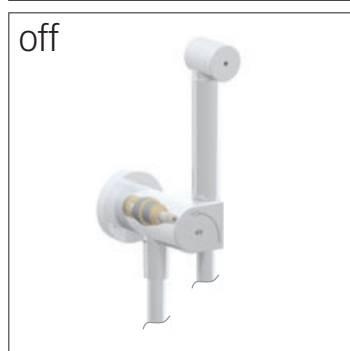

HYDROSCOPINO CON EROGAZIONE UNICA TIPO LASER  
HYDROBRUSH WITH ONLY SPRAYER LIKE LASER

ART. 0403/ID/1, 0903/ID/1, 7503/ID/1, 3303/ID/1, 0303/ID/1

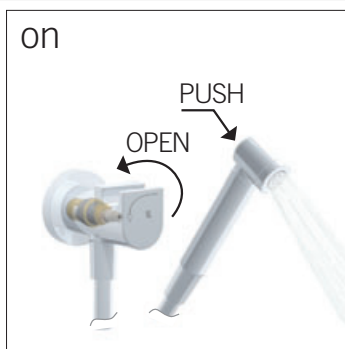

HYDROSCOPINO CON EROGAZIONE UNICA TIPO DOCCETTA  
HYDROBRUSH WITH ONLY SPRAYER LIKE HANDSHOWER

ART. 0403/ID, 0903/ID, 7503/ID, 3303/ID, 0303/ID, 1403/ID, 4503/ID

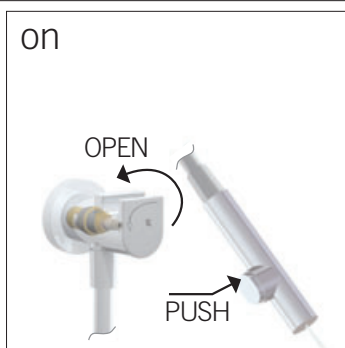

HYDROSCOPINO CON EROGAZIONE UNICA SUPERIORE TIPO LASER  
HYDROBRUSH WITH ONLY SPRAYER UP LIKE LASER

ART. 0403/ID/LA, 0903/ID/LA, 0303/ID/LA

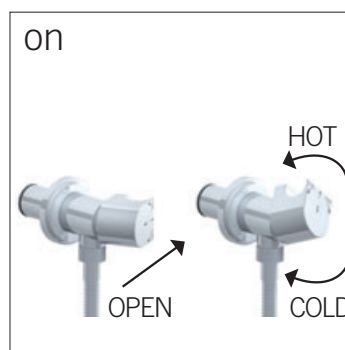

GANCIO DOCCETTA BIDET COMPLETO CON MISCELATORE INTEGRATO  
COMPLETE HOOK HAND SHOWER BIDET WITH INTEGRATE MIXER

ART. 0403/MI, 0903/MI, 7503/MI, 3303/MI, 0303/MI, 1403/MI

0403/ID/1

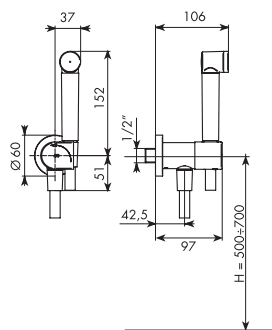

IDROSCOPINO TONDO LASER

- > vitone ceramico 90°
- > apertura incorporata
- > apertura con rotazione antioraria
- > flessibile in PVC da 90 cm
- > attacco da 1/2"
- > getto laser frontale ad alta pressione
- > rosone tondo

755057  
p. 160

CROMATO

01-0403/ID/1 €

ALTRE FINITURE

XX-0403/ID/1 € x M\*

0403/ID

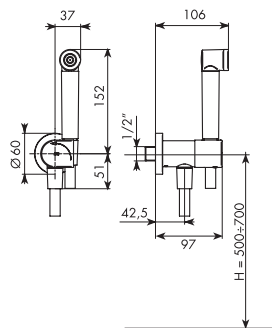

IDROSCOPINO TONDO SPRAY

- > vitone ceramico 90°
- > apertura incorporata
- > apertura con rotazione antioraria
- > flessibile in PVC da 90 cm
- > attacco da 1/2"
- > getto spray frontale
- > rosone tondo

755057  
p. 160

CROMATO

01-0403/ID €

ALTRE FINITURE

XX-0403/ID € x M\*

0403/ID/LA

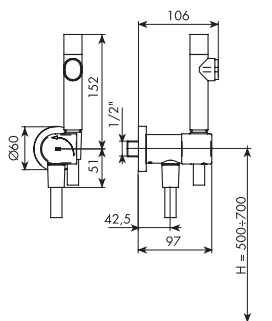

IDROSCOPINO TONDO LASER MINI

- > vitone ceramico 90°
- > apertura incorporata
- > apertura con rotazione antioraria
- > flessibile in PVC da 90 cm
- > attacco da 1/2"
- > getto laser superiore ad alta pressione
- > rosone tondo

755057  
p. 160

CROMATO

01-0403/ID/LA €

0903/ID/1

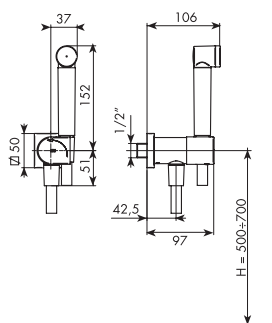

IDROSCOPINO TONDO LASER

- > vitone ceramico 90°
- > apertura incorporata
- > apertura con rotazione antioraria
- > flessibile in PVC da 90 cm
- > attacco da 1/2"
- > getto laser frontale ad alta pressione
- > rosone quadro

755057  
p. 160

CROMATO

01-0903/ID/1 €

ALTRE FINITURE

XX-0903/ID/1 € x M\*

0903/ID

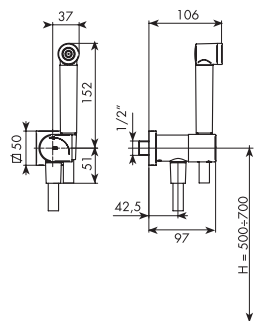

IDROSCOPINO TONDO SPRAY

- > vitone ceramico 90°
- > apertura incorporata
- > apertura con rotazione antioraria
- > flessibile in PVC da 90 cm
- > attacco da 1/2"
- > getto spray frontale
- > rosone quadro

755057  
p. 160

CROMATO

01-0903/ID € 360,00

ALTRE FINITURE

XX-0903/ID € 360,00 x M\*

0903/ID/LA

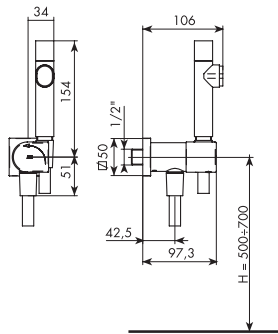

IDROSCOPINO TONDO LASER MINI

- > vitone ceramico 90°
- > apertura incorporata
- > apertura con rotazione antioraria
- > flessibile in PVC da 90 cm
- > attacco da 1/2"
- > getto laser superiore ad alta pressione
- > rosone quadro

755057  
p. 160

CROMATO

01-0903/ID/LA

€

7503/ID/1

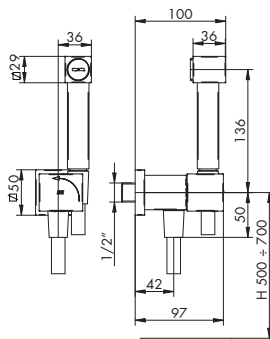

IDROSCOPINO QUADRO LASER

- > vitone ceramico 90°
- > apertura incorporata
- > apertura con rotazione antioraria
- > flessibile in PVC da 90 cm
- > attacco da 1/2"
- > getto laser frontale ad alta pressione
- > corpo e rosone quadri

755057  
p. 160

CROMATO

01-7503/ID/1

€

ALTRE FINITURE

XX-7503/ID/1

€

x M\*

7503/ID

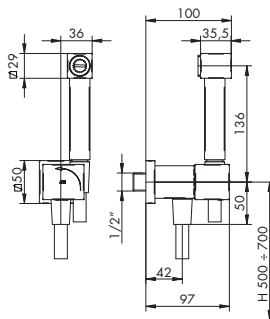

IDROSCOPINO QUADRO SPRAY

- > vitone ceramico 90°
- > apertura incorporata
- > apertura con rotazione antioraria
- > flessibile in PVC da 90 cm
- > attacco da 1/2"
- > getto spray frontale
- > corpo e rosone quadri

755057  
p. 160

CROMATO

01-7503/ID

€

ALTRE FINITURE

XX-7503/ID

€

x M\*

3303/ID/1

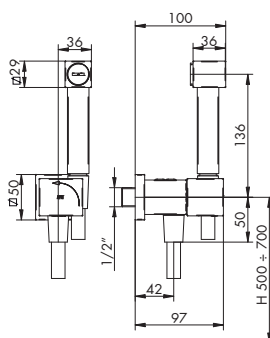

IDROSCOPINO QUADRO LASER CON SWAROVSKI

- > vitone ceramico 90°
- > apertura incorporata
- > apertura con rotazione antioraria
- > flessibile in PVC da 90 cm
- > attacco da 1/2"
- > getto laser frontale ad alta pressione
- > corpo e rosone quadri
- > corpo con SWAROVSKI

755057  
p. 160

CROMATO

01-3303/ID/1

€

ALTRE FINITURE

XX-3303/ID/1

€

x M\*

3303/ID

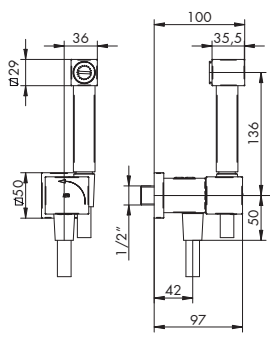

IDROSCOPINO QUADRO SPRAY CON SWAROVSKI

- > vitone ceramico 90°
- > apertura incorporata
- > apertura con rotazione antioraria
- > flessibile in PVC da 90 cm
- > attacco da 1/2"
- > getto spray frontale
- > corpo e rosone quadri
- > corpo con SWAROVSKI

755057  
p. 160

CROMATO

01-3303/ID

€

ALTRE FINITURE

XX-3303/ID

€

x M\*

0303/ID/1

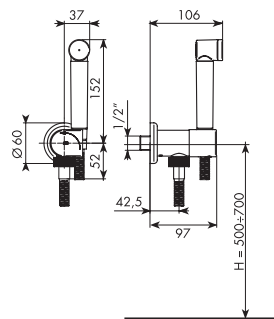

IDROSCOPINO TONDO LASER

- > vitone ceramico 90°
- > apertura incorporata
- > apertura con rotazione antioraria
- > flessibile in metallo da 90 cm
- > attacco da 1/2"
- > getto laser frontale ad alta pressione
- > rosone tondo

755057  
p. 160

CROMATO		ALTRE FINITURE	
01-0303/ID/1	€	XX-0303/ID/1	€ x M*

0303/ID

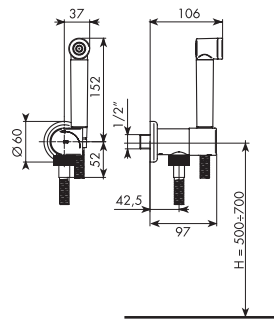

IDROSCOPINO TONDO SPRAY

- > vitone ceramico 90°
- > apertura incorporata
- > apertura con rotazione antioraria
- > flessibile in metallo da 90 cm
- > attacco da 1/2"
- > getto spray frontale
- > rosone tondo

755057  
p. 160

CROMATO		ALTRE FINITURE	
01-0303/ID	€	XX-0303/ID	€ x M*

0303/ID/LA

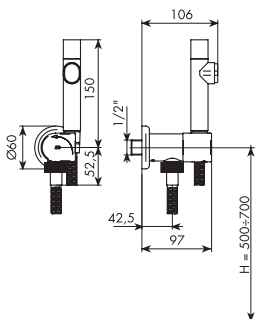

IDROSCOPINO TONDO LASER MINI

- > vitone ceramico 90°
- > apertura incorporata
- > apertura con rotazione antioraria
- > flessibile in metallo da 90 cm
- > attacco da 1/2"
- > getto laser superiore ad alta pressione
- > rosone tondo

755057  
p. 160

CROMATO		ALTRE FINITURE	
01-0303/ID/LA	€	XX-0303/ID/LA	€ x M*

1403/ID/1

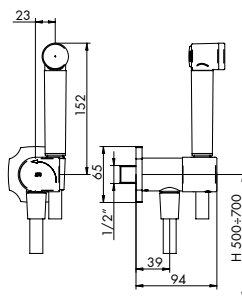

IDROSCOPINO TONDO ROSONE CLASSIC LASER

- > vitone ceramico 90°
- > apertura incorporata
- > apertura con rotazione antioraria
- > flessibile in metallo da 90 cm
- > attacco da 1/2"
- > getto laser frontale ad alta pressione
- > rosone classic

755057  
p. 160

CROMATO		ALTRE FINITURE	
01-1403/ID/1	€	XX-1403/ID/1	€ x M*

1403/ID

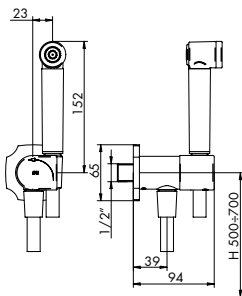

IDROSCOPINO TONDO ROSONE CLASSIC SPRAY

- > vitone ceramico 90°
- > apertura incorporata
- > apertura con rotazione antioraria
- > flessibile in metallo da 90 cm
- > attacco da 1/2"
- > getto spray frontale
- > rosone classic

755057  
p. 160

CROMATO		ALTRE FINITURE	
01-1403/ID	€	XX-1403/ID	€ x M*

4503/ID

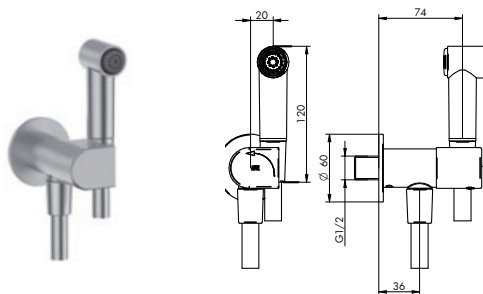

IDROSCOPINO INOX COMPLETO

- > vitone ceramico 90°
- > apertura incorporata
- > apertura con rotazione antioraria
- > flessibile in PVC da 90 cm
- > attacco da 1/2"
- > getto spray frontale c/anticalcare
- > rosone tondo

755057  
p. 160

INOX AISI 316L

77-4503/ID

€

0403/MI/E + 034134

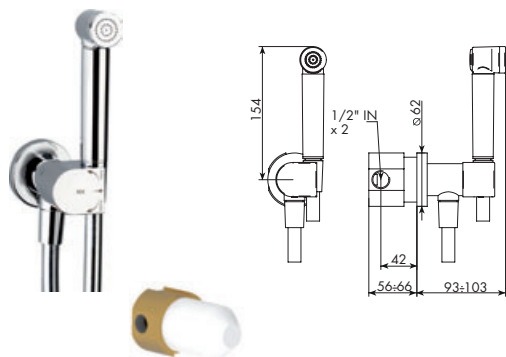

IDROMISCELATORE TONDO

- > cartuccia tradizionale incorporata
- > getto spray frontale
- > flessibile in PVC da 90 cm
- > da abbinare a parte incasso
- > attacchi da 1/2"
- > rosone tondo

735005  
p. 160

PARTI ESTERNE - CROMATO

01-0403/MI/E €

PARTI ESTERNE - ALTRE FINITURE

XX-0403/MI/E € x M\*

PARTE INCASSO

034134 info pag. 43 €

PREZZO TOTALE €

7503/MI/E + 034134

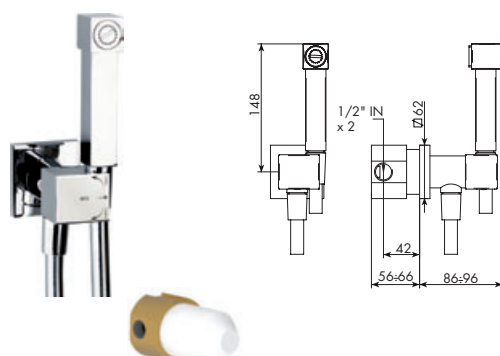

IDROMISCELATORE QUADRO

- > cartuccia tradizionale incorporata
- > getto spray frontale
- > flessibile in PVC da 90 cm
- > da abbinare a parte incasso
- > attacchi da 1/2"
- > corpo e rosone quadro

735005  
p. 160

PARTI ESTERNE - CROMATO

01-7503/MI/E €

PARTI ESTERNE - ALTRE FINITURE

XX-7503/MI/E € x M\*

PARTE INCASSO

034134 info pag. 43 €

PREZZO TOTALE €

0303/MI/E + 034134

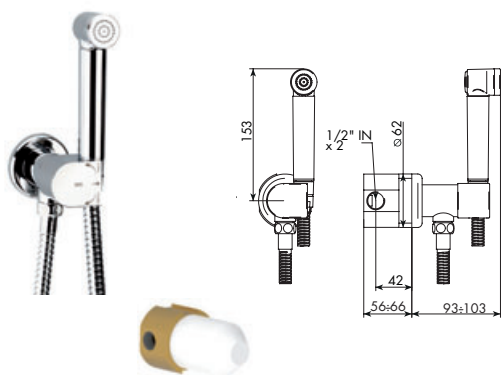

IDROMISCELATORE CLASSIC

- > cartuccia tradizionale incorporata
- > getto spray frontale
- > flessibile in metallo da 90 cm
- > da abbinare a parte incasso
- > attacchi da 1/2"
- > rosone tondo

735005  
p. 160

PARTI ESTERNE - CROMATO

01-0303/MI/E €

PARTI ESTERNE - ALTRE FINITURE

XX-0303/MI/E € x M\*

PARTE INCASSO

034134 info pag. 43 €

PREZZO TOTALE €

1403/MI/E + 034134

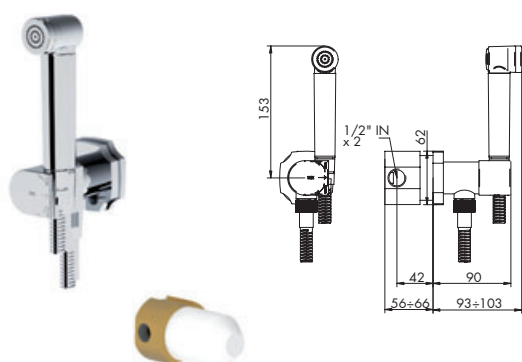

IDROMISCELATORE TONDO ROSONE CLASSIC

- > cartuccia tradizionale incorporata
- > getto spray frontale
- > flessibile in metallo da 90 cm
- > da abbinare a parte incasso
- > attacchi da 1/2"
- > rosone classic

735005  
p. 160

PARTI ESTERNE - CROMATO

01-1403/MI/E €

PARTI ESTERNE - ALTRE FINITURE

XX-1403/MI/E € x M\*

PARTE INCASSO

034134 info pag. 43 €

PREZZO TOTALE €

018/5+

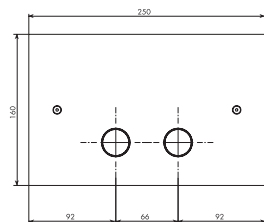

PIASTRA PER CASSETTA WC

- > compatibile cassette UP720/Sigma8 - UP320/Sigma12
- > doppio pulsante simmetrico a filo
- > piastra rettangolare

CROMATO		ALTRE FINITURE	
01-018/5+	€	XX-018/5+	€ x M*

018/4

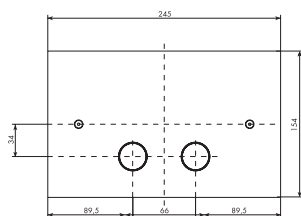

PIASTRA PER CASSETTA WC

- > compatibile cassette UP700
- > doppio pulsante simmetrico a filo
- > piastra rettangolare

CROMATO		ALTRE FINITURE	
01-018/4	€	XX-018/4	€ x M*

018/2

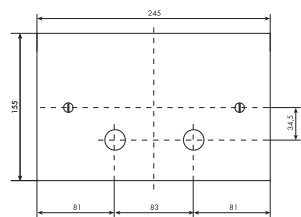

PIASTRA PER CASSETTA WC

- > compatibile cassette UP700
- > doppio pulsante simmetrico sporgente
- > piastra rettangolare

CROMATO		ALTRE FINITURE	
01-018/2	€	XX-018/2	€ x M*

018/6+

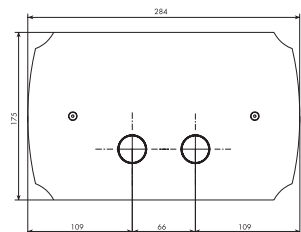

PIASTRA PER CASSETTA WC

- > compatibile cassette UP720/Sigma8 - UP320/Sigma12
- > doppio pulsante simmetrico in rilievo
- > piastra classic

CROMATO		ALTRE FINITURE	
01-018/6+	€	XX-018/6+	€ x M*

018/3

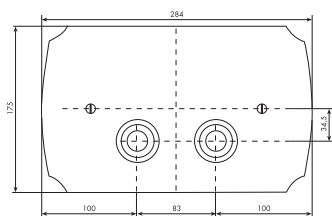

PIASTRA PER CASSETTA WC

- > compatibile cassette UP700
- > doppio pulsante simmetrico in rilievo sagomato
- > piastra classic

CROMATO		ALTRE FINITURE	
01-018/3	€	XX-018/3	€ x M*

018/7X

## PIASTRA INOX PER CASSETTA WC

- > compatibile cassette UP720/Sigma8 - UP320/Sigma12
- > doppio pulsante simmetrico quadro a filo
- > piastra rettangolare

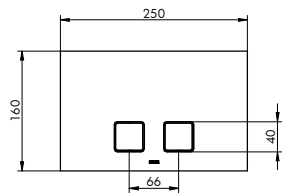

INOX AISI 316L

77-018/7X

€



POSSIBILITA' D'IMPIEGO

1) BORDO V-BOX CON PIASTRA RIVESTITA  
1) BORDO V-BOX WITH FACED PLATE

A - BORDO V-BOX CON PIASTRA RIVESTITA (012/3, 012/4, 012/5)  
A - BORDO V-BOX WITH FACED PLATE (012/3, 012/4, 012/5)

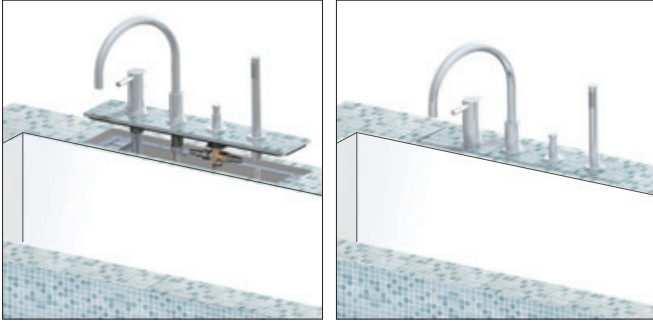

B - BORDO V-BOX CON PIASTRA RIVESTITA. OPTIONAL: SISTEMA DI PRE-INSTALLAZIONE (012/6)

B - BORDO V-BOX WITH FACED PLATE. OPTIONAL: PRE-INSTALLATION SYSTEM (012/6)



C - BORDO V-BOX CON PIASTRA RIVESTITA. OPTIONAL: SISTEMA DI PRE-INSTALLAZIONE (012/6) E VASCHETTA DI RACCOLTA (012/7)

C - BORDO V-BOX WITH FACED PLATE. OPTIONAL: PRE-INSTALLATION SYSTEM (012/6) AND COLLECTION CASE (012/7)



POSSIBLE WAY OF WORKING

2) BORDO V-BOX CON PIASTRA A VISTA IN FINITURA  
2) BORDO V-BOX WITH AT SIGHT FINISHED PLATE

A - BORDO V-BOX CON PIASTRA A VISTA IN FINITURA (012/3, 012/4, 012/5)  
A - BORDO V-BOX WITH AT SIGHT FINISHED PLATE (012/3, 012/4, 012/5)



B - BORDO V-BOX CON PIASTRA A VISTA IN FINITURA. OPTIONAL: SISTEMA DI PRE-INSTALLAZIONE (012/6)

B - BORDO V-BOX WITH AT SIGHT FINISHED PLATE. OPTIONAL: PRE-INSTALLATION SYSTEM (012/6)



C - BORDO V-BOX CON PIASTRA A VISTA IN FINITURA. OPTIONAL: SISTEMA DI PRE-INSTALLAZIONE (012/6) E VASCHETTA DI RACCOLTA (012/7)

C - BORDO V-BOX WITH AT SIGHT FINISHED PLATE. OPTIONAL: PRE-INSTALLATION SYSTEM (012/6) AND COLLECTION CASE (012/7)



012/3

PIASTRA PER BORDO VASCA 3 FORI

- > in acciaio INOX
- > possibilità di coprire con rivestimento
- > interasse fori 110 mm
- > abbinabile a 012/6 + 012/7

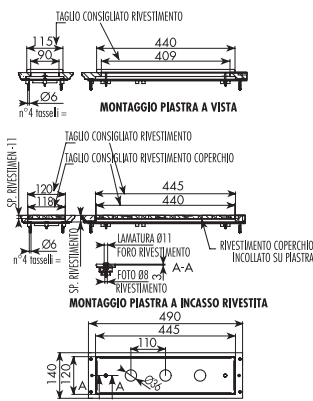

CROMATO		ALTRE FINITURE	
01-012/3	€	XX-012/3	€ x M*

012/4

PIASTRA PER BORDO VASCA 4 FORI

- > in acciaio INOX
- > possibilità di coprire con rivestimento
- > interasse fori 110 mm
- > abbinabile a 012/6 + 012/7

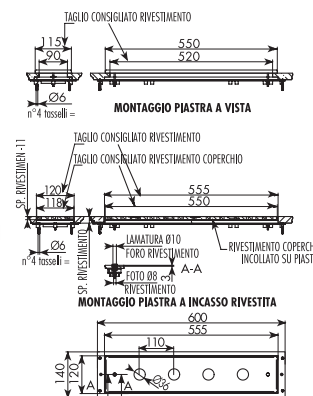

CROMATO		ALTRE FINITURE	
01-012/4	€	XX-012/4	€ x M*

012/5

PIASTRA PER BORDO VASCA 5 FORI

- > in acciaio INOX
- > possibilità di coprire con rivestimento
- > interasse fori 110 mm
- > abbinabile a 012/6 + 012/7

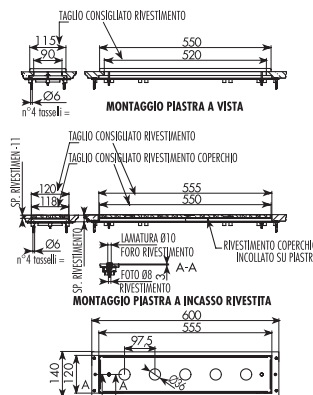

CROMATO		ALTRE FINITURE	
01-012/5	€	XX-012/5	€ x M*

012/6

PREDISPOSIZIONE PER PIASTRA BORDO VASCA

- > registrabile
- > abbinabile a 012/3 o 012/4 o 012/5

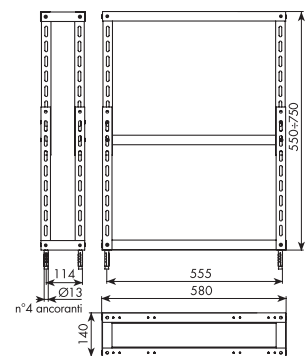

SENZA FINITURA	
012/6	€

012/7

VASCHETTA PER PREDISPOSIZIONE BORDO VASCA

- > comprensiva di tubetto collegamento scarico predisposto
- > comprensiva di attacco per fianco vasca per scarico
- > da combinare sempre a 012/6

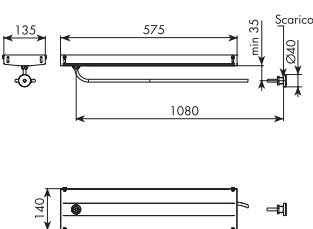

SENZA FINITURA	
012/7	€