

Starck Design by Philippe Starck

Product Information

Fronts Body Vanity Unit # S1 9523 and # S1 9520	Real wood veneer Pricegroup 3	05 Oak 13 American Walnut 24 Macassar	Basic material: Base: solid wood, multiplex curved pasted plywood. Outside real wood veneer, colorless lacquered. Interior finish: laminate (HPL) in (57) Black Diamond for # S1 9523 and laminate (HPL) in black for # S1 9520. Edge material: one-sided Trim in real wood veneer. Real wood veneer is a natural material, differences in color and structure may occur.
	Lacquer Pricegroup 4	40 Black High Gloss 85 White High Gloss	Basic material: Base: solid wood, multiplex curved pasted plywood. Outside lacquered opaque in several coats. Interior finish: laminate (HPL) in (57) Black Diamond for # S1 9523 and laminate (HPL) in black for # S1 9520. Edge material: one-sided ABS-Edge material (lacquered).
Fronts Body # S1 9526, S1 9528, S1 9529, S1 9108	Real wood veneer Pricegroup 3	05 Oak 13 American Walnut 24 Macassar	Basic material: High-compressed three-ply chipboard. Outside real wood veneer, colorless lacquered. Interior finish: laminate (HPL) in (57) Black Diamond. Edge material: Trim in real wood veneer. Real wood veneer is a natural material, differences in color and structure may occur.
	Lacquer Pricegroup 4	40 Black High Gloss 85 White High Gloss	Basic material: High-compressed MDF board. Lacquered opaque in several coats. Interior finish: laminate (HPL) in (57) Black Diamond. Edge material: ABS-Edge material (lacquered).
Fronts # S1 9526, S1 9528, S1 9529, S1 9108	Real wood veneer Pricegroup 3	05 Oak 13 American Walnut 24 Macassar	Basic material: Lightweight building board, consisting of 2 three-ply chipboard with honeycomb core layer. Outside real wood veneer, colorless lacquered. Interior finish: laminate (HPL) in (57) Black Diamond. Edge material: Edges on top and above in real wood veneer, colorless lacquered. Vanity units with side edges of vanity units with coverprofile (anodized aluminum profile), tall cabinet with cover profile only on handle edge. Real wood veneer is a natural material, differences in color and structure may occur.
	Lacquer Pricegroup 4	40 Black High Gloss 85 White High Gloss	Basic material: Lightweight building board, consisting of 2 three-ply chipboard with honeycomb core layer. Outside lacquered opaque in several coats. Interior finish: laminate (HPL) in (57) Black Diamond. Edge material: ABS-Edge material (lacquered). Side edges of vanity units with coverprofile (anodized aluminum profile), tall cabinet with cover profile only on handle edge.
Edges Mirror ground plate Body Mirror Cabinet		Neutral	Basic material: High-compressed MDF board directly coated. Edge material: ABS-Edge material.
Box drawer for mirror cabinets + vanity unit # S1 9523	Lack	37 White Aluminum	Solid wood, all sides lacquered (open porous).
Handles furniture # S1 9520		Chrome	Brass, chrome
Handles furniture # S1 9523		Silver anodized	Aluminum
Cover profile vanity units and tall cabinet		Silver anodized	Aluminum
Extension mechanism		Without handle	Push-to-open technology with self-closing mechanism.

Starck Design by Philippe Starck

Product Information

Interior System	Real Wood massive Pricegroup 1	77 Amer. Walnut massive 78 Maple massive	The interior system with a material mix in acryl glass and solid wood is available in maple or walnut. There is an individually designed interior system for each cabinet width between 23 5/8" - 47 1/4". Each size of the cabinet have a individual layout of the interior systems to use the optimum storage space. The box cover plus the small and big wave have a special anti-slip lacquer.
------------------------	--	---	--

Starck Design by Philippe Starck

Ordering Sample

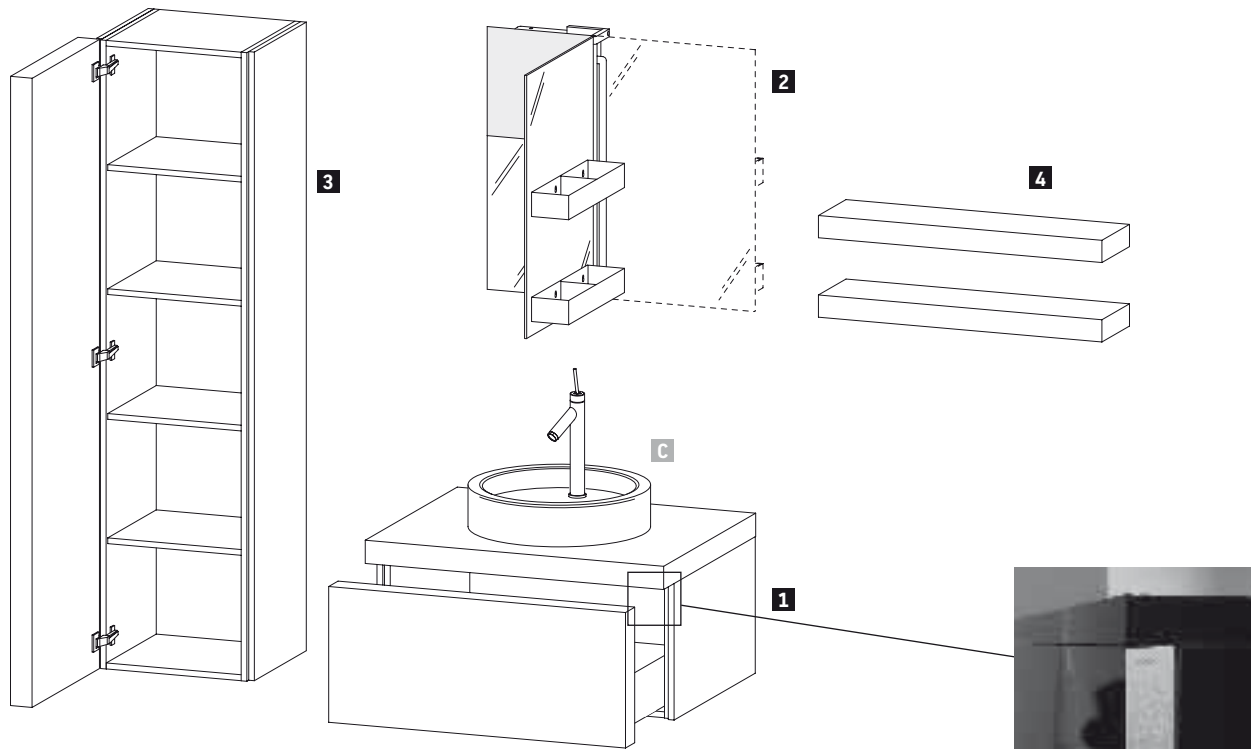

Starck
Vanity Unit, Tall cabinet
Wall board

85 White High Gloss
05 Oak

Description	Remark	Quantity	Model-No.
1 Vanity unit wall mounted	Width 32 7/8"	1	# S1 9526 0 85 85
2 Mirror cabinet	Width 29 1/2"	1	# S1 9721 R 00 00
3 Tall cabinet	Width 15 3/4"	1	# S1 9108 L 85 85
4 Wall board	Width 31 1/2"	2	# S1 9428 0 05 05
C Washbowl Starck 18 1/2"		1	# 038647 00 271

Starck Design by Philippe Starck

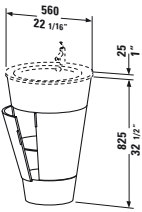
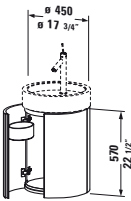
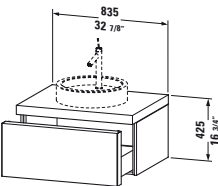
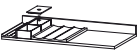
Description	inch	Model-No.	USD			
			Pricegroup 1	Pricegroup 2	Pricegroup 3	Pricegroup 4
 <p>Vanity unit floor standing 1 glass shelf with rail, Width 37" (opened) for Starck 1 # 040658</p>	22" x 23 5/8"	S1 9520			4,770	6,070
Infobox: # S1 9520 available from stock: 05-Oak, 13-American Walnut, 24-Macassar, 40-Black High Gloss, 85-White High Gloss / Siphon for washbasin # 005026 is recommended / Ceramic is not included, please order separately.						
 <p>Vanity unit wall-mounted circular, 2 doors, 2 wooden boxes, width 35 3/8" (opened) for Starck 1 # 038647 (not ground)</p>	17 3/4" x 19 5/8"	S1 9523			3,715	3,980
Infobox: Siphon for washbasin # 005026 is recommended						
 <p>Vanity unit wall-mounted 1 pull-out compartment 1 countertop including one central cut-out 32 7/8" x 22 1/4"</p>		S1 9526			2,440	2,650
 <p>Additional modules Interior system for pull-out compartment in maple or walnut solid wood for cabinet widths 32 7/8" without siphon cut-out</p>	32 7/8"	UV 9850	375			
Infobox: Including handleless push-to-open technology / Interior modules can not be retrofitted, are factory installed and must be requested upon ordering / Space saving siphon # 005073 is recommended - Model no. ceramic, please refer to page 555 / Required specification for ordering: / # S1 9526 available from stock without basin cut-out: 24-Macassar, 40-Black High Gloss and 85-White High Gloss - Interior module yes or no - Walnut-77 or Maple-78 / Stocked vanities do not include interior modules						

Starck Design by Philippe Starck

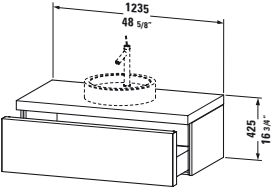
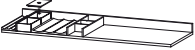
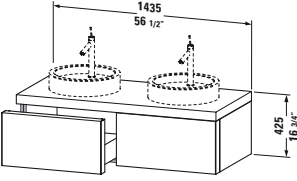
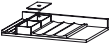
Description	inch	Model-No.	USD			
			Pricegroup 1	Pricegroup 2	Pricegroup 3	Pricegroup 4
						
Vanity unit wall-mounted						
1 pull-out compartment						
countertop including one cut-out	48 5/8" x 22 1/4"	S1 9528 L/M/R			2,880	3,130
						
Additional modules						
Interior system for pull-out compartment in maple or walnut solid wood for cabinet widths 48 5/8" without siphon						
cut-out	48 5/8"	UV 9851	540			
Infobox: Including handleless push-to-open technology / Interior modules can not be retrofitted, are factory installed and must be requested upon ordering / Space saving siphon # 005073 is recommended - L/R/M = Washbasin left, right or middle possible - Model no. ceramic, please refer to page 555 / Required specification for ordering: - Interior module yes or no - Walnut-77 or Maple-78						
						
Vanity unit wall-mounted						
2 pull-out compartments						
1 countertop with one cut-out or two cut-outs	56 1/2" x 22 1/4"	S1 9529 B/L/R			3,700	3,995
						
Additional modules						
Interior system for pull-out compartment in maple or walnut solid wood for cabinet widths 56 1/2" without siphon						
cut-out left / right	56 1/2"	UV 9852	225			
for cabinet widths 56 1/2" without siphon cut-out on either side	56 1/2"	UV 9853	450			
Infobox: Including handleless push-to-open technology / Interior modules can not be retrofitted, are factory installed and must be requested upon ordering / Space saving siphon # 005073 is recommended - L/R/B = Washbasin left, right or both sides possible - Model no. ceramic, please refer to page 555 / Required specification for ordering: - Interior module yes or no - position of interior system on left, right or both sides - Walnut-77 or Maple-78						

Starck Design by Philippe Starck

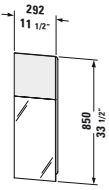
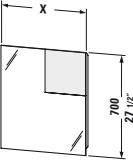
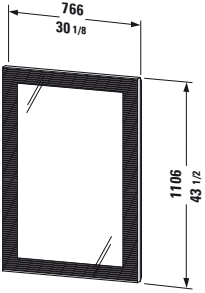
Description	inch	Model-No.	USD			
			Pricegroup 1	Pricegroup 2	Pricegroup 3	Pricegroup 4
 <p>Mirror with lighting ciAPMO@ELECTRICAL, 1 compact fluorescent tube Dulux F 24 W 840 CW, Mirrors require a GFCI 110 V 60 Hz power source. Flat plug will be supplied with mirror, 1 sensor switch</p>						
	11 1/2" x 3 7/8"	S1 9716	1,110			
Infobox: Distance between sensor and reflecting surfaces = minimum 3" / # S1 9716 is available from stock						
 <p>Mirror with lighting ciAPMO@ELECTRICAL, 1 compact fluorescent tube Dulux F 24 W 840 CW, Mirrors require a GFCI 110 V 60 Hz power source. Flat plug will be supplied with mirror, 1 sensor switch</p>						
	23 5/8" x 3 7/8"	S1 9717	1,365			
	29 1/2" x 3 7/8"	S1 9718	1,435			
Infobox: Distance between sensor and reflecting surfaces = minimum 3" / # S1 9717 and S1 9718 are available from stock						
 <p>Mirror with lighting ciAPMO@ELECTRICAL, Mirrors require a GFCI 110 V 60 Hz power source. Flat plug will be supplied with mirror, 1 sensor switch bottom right LED module 3500 kelvin light color, 54 W 30 1/8" x 2 3/8"</p>						
		S1 9641	3,995			
Infobox: Distance between sensor and reflecting surfaces = minimum 3"						

Starck Design by Philippe Starck

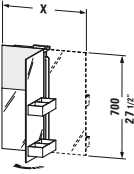
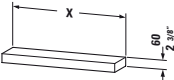
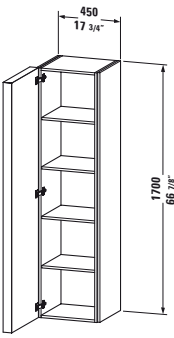
Description	inch	Model-No.	USD			
			Pricegroup 1	Pricegroup 2	Pricegroup 3	Pricegroup 4
 <p>Mirror cabinet ciAPMO®ELECTRICAL, 1 compact fluorescent tube Dulux F 24 W 840 CW, 1 mirror door, 2 wooden boxes, Mirror cabinets require a GFCI 110 V 60 Hz power source. Flat plug will be supplied with the mirror cabinet, 1 sensor switch, GFCI outlets are not supplied by the manufacturer (GFCI outlets can be added to the cabinet by a certified electrician on the job site)</p>						
	23 5/8" x 5 3/8"	S1 9720 L/R	1,850			
	29 1/2" x 5 3/8"	S1 9721 L/R	1,945			
Infobox: Hinges central / Door can be opened 180° / The picture shows version „right“ / Required specification for ordering: - hinge position left (L) or right (R)						
 <p>Wall board 1 shelf, fixation with locking pin</p>						
	23 5/8" x 7 7/8"	S1 9427			370	395
	31 1/2" x 7 7/8"	S1 9428			420	455
	47 1/4" x 7 7/8"	S1 9429			475	515
Infobox: # S1 9427 available from stock: 24-Macassar, 40-Black High Gloss, 85-White High Gloss						
 <p>Tall cabinet 1 door, 4 glass shelves with aluminum brackets Width 18 7/8" (opened)</p>						
	17 3/4" x 16 1/2"	S1 9108 L/R			2,920	3,155
Infobox: Required specification for ordering: - Hinges left (L) or right (R) / # S1 9108 L/R available from stock: 24-Macassar, 40-Black High Gloss, 85-White High Gloss						