

**Starck** Design by Philippe Starck

**Bathtub oval, freestanding, with one backrest slope, with acrylic panel and support frame**  
 1/4" sanitary acrylic

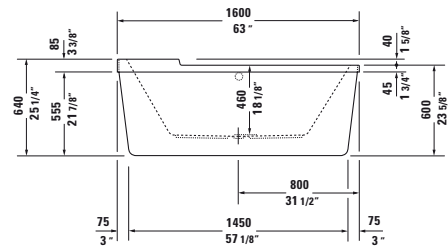
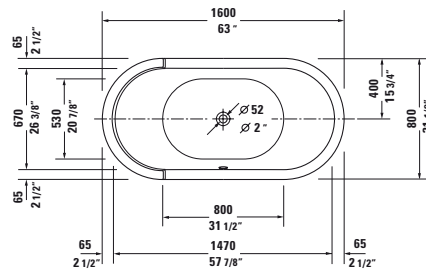

Length inch	Width inch	Depth/Height inch	Capacity gal	Weight lbs	Model-No.	USD
						White - 00
<b>Bathtub</b>						
63"	31 1/2"	18 1/8"	37.0	101.4	<b>700409 00 0 00 0090</b>	<b>3,975</b>
<b>Accessories for bath- and whirtub</b>						
Cable-driven waste and overflow, for central outlet, plastic, Chrome trim, (included)					<b>790237 00 0 00 1000</b>	<b>270</b>

**Starck** Design by Philippe Starck

**Bathtub oval, built-in, with two backrest slopes, cUPC listed**  
1/4" sanitary acrylic

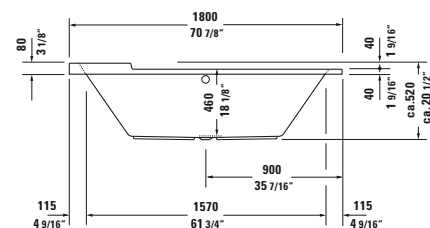
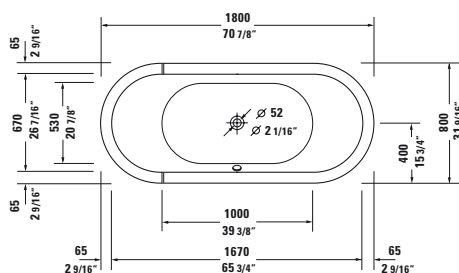

Length inch	Width inch	Depth/Height inch	Capacity gal	Weight lbs	Model-No.	USD
						White - 00
<b>Bathtub</b>						
70 7/8"	31 1/2"	18 1/8"	45.0	57.3	<b>700009 00 0 00 0090</b>	<b>2,915</b>
<b>Bathtub inclusive whirlsystem</b>						
Air-System					<b>710009 00 1 00 1090</b>	4,680
Jet-System					<b>710009 00 2 00 1090</b>	4,680
Jet-System with heater					<b>710009 00 2 50 1090</b>	5,115
Jet-System with heater and ozone					<b>710009 00 2 51 1090</b>	6,465
Combi-System					<b>710009 00 3 00 1090</b>	5,900
Combi-System with heater					<b>710009 00 3 50 1090</b>	6,330
Combi-System with heater and ozone					<b>710009 00 3 51 1090</b>	7,680
Combi-System with light					<b>710009 00 4 00 1090</b>	6,545
Combi-System with light and heater					<b>710009 00 4 50 1090</b>	6,965
Combi-System with light, heater and ozone					<b>710009 00 4 51 1090</b>	8,315
Air-System with remote					<b>710009 00 1 46 1090</b>	5,330
Jet-System with remote					<b>710009 00 2 46 1090</b>	5,330
Jet-System with remote and heater					<b>710009 00 2 52 1090</b>	5,745
Jet-System with remote, heater and ozone					<b>710009 00 2 53 1090</b>	7,105
Combi-System with remote					<b>710009 00 3 46 1090</b>	6,545
Combi-System with remote and heater					<b>710009 00 3 52 1090</b>	6,965
Combi-System with remote, heater and ozone					<b>710009 00 3 53 1090</b>	8,315
Combi-System with light and remote					<b>710009 00 4 46 1090</b>	7,150
Combi-System with light, remote and heater					<b>710009 00 4 52 1090</b>	7,615
Combi-System with light, remote, heater and ozone					<b>710009 00 4 53 1090</b>	8,945
<b>Accessories for bath- and whirltub</b>						
Cable-driven waste and overflow, plastic, Chrome trim					<b>790219 00 0 00 1000</b>	225
Support frame, (included)					<b>790108 00 0 00 0000</b>	160
Stereo transducers (speakers) for bathtubs and whirltubs					<b>791818 00 0 00 0000</b>	1,750

**Infobox:** Bathtubs are cUPC listed / Bathtubs with whirlsystem are cUPC and cIAPMO®ELECTRICAL listed

**Starck** Design by Philippe Starck

**Bathtub oval, freestanding, with two backrest slopes, with acrylic panel and support frame, cUPC listed**  
 1/4" sanitary acrylic

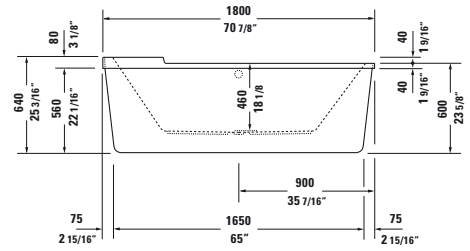
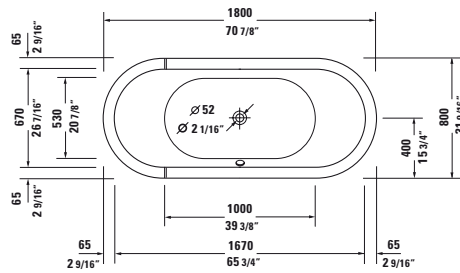

Length inch	Width inch	Depth/Height inch	Capacity gal	Weight lbs	Model-No.	USD
						White - 00
<b>Bathtub</b>						
70 7/8"	31 1/2"	18 1/8"	45.0	127.9	<b>700010 00 0 00 0090</b>	<b>4,280</b>
<b>Bathtub inclusive whirlsystem</b>						
Air-System					<b>710010 00 1 00 1090</b>	6,545
Air-System with ozone					<b>710010 00 1 54 1090</b>	7,850
Air-System with remote					<b>710010 00 1 46 1090</b>	7,150
Air-System with remote and ozone					<b>710010 00 1 55 1090</b>	8,530
Air-System with remote and light					<b>710010 00 1 57 1090</b>	7,635
Air-System with remote, ozone and light					<b>710010 00 1 59 1090</b>	8,975
<b>Accessories for bath- and whirltub</b>						
Cable-driven waste and overflow, for central outlet, plastic, Chrome trim, (included)					<b>790237 00 0 00 1000</b>	<b>270</b>
Stereo transducers (speakers) for bathtubs and whirltubs					<b>791818 00 0 00 0000</b>	<b>1,750</b>

**Infobox:** Bathtubs are cUPC listed / Bathtubs with whirlsystem are cUPC and cIAPMO@ELECTRICAL listed

**Starck** Design by Philippe Starck

**Bathtub oval, built-in, with two backrest slopes, cUPC listed**  
1/4" sanitary acrylic

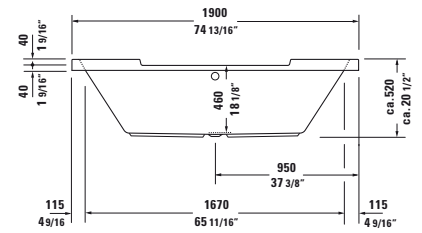
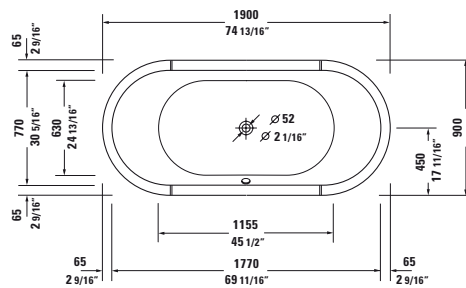

Length inch	Width inch	Depth/Height inch	Capacity gal	Weight lbs	Model-No.	USD
						White - 00
<b>Bathtub</b>						
74 3/4"	35 1/2"	18 1/8"	60.0	70.5	<b>700011 00 0 00 0090</b>	<b>3,595</b>
<b>Bathtub inclusive whirlsystem</b>						
					<b>710011 00 1 00 1090</b>	6,410
					<b>710011 00 2 00 1090</b>	6,410
					<b>710011 00 2 50 1090</b>	6,845
					<b>710011 00 2 51 1090</b>	8,195
					<b>710011 00 3 00 1090</b>	8,145
					<b>710011 00 3 50 1090</b>	8,575
					<b>710011 00 3 51 1090</b>	9,925
					<b>710011 00 4 00 1090</b>	8,585
					<b>710011 00 4 50 1090</b>	9,020
					<b>710011 00 4 51 1090</b>	10,365
					<b>710011 00 1 46 1090</b>	7,060
					<b>710011 00 2 46 1090</b>	7,060
					<b>710011 00 2 52 1090</b>	7,480
					<b>710011 00 2 53 1090</b>	8,820
					<b>710011 00 3 46 1090</b>	8,790
					<b>710011 00 3 52 1090</b>	9,220
					<b>710011 00 3 53 1090</b>	10,560
					<b>710011 00 4 46 1090</b>	9,230
					<b>710011 00 4 52 1090</b>	9,665
					<b>710011 00 4 53 1090</b>	11,010
<b>Accessories for bath- and whirltub</b>						
					<b>790219 00 0 00 1000</b>	225
					<b>790110 00 0 00 0000</b>	160
					<b>791818 00 0 00 0000</b>	1,750

**Infobox:** Bathtubs are cUPC listed / Bathtubs with whirlsystem are cUPC and cIAPMO®ELECTRICAL listed

**Starck** Design by Philippe Starck

**Bathtub oval, freestanding, with two backrest slopes, with acrylic panel and support frame, cUPC listed**  
 1/4" sanitary acrylic

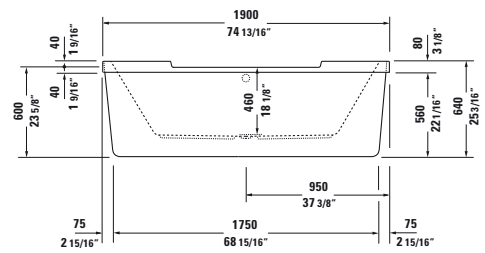
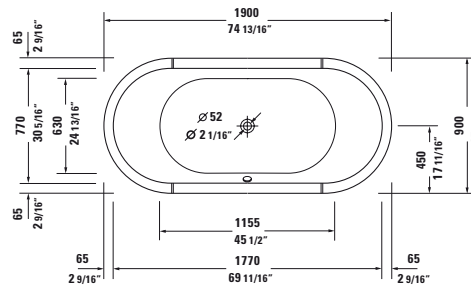

Length inch	Width inch	Depth/Height inch	Capacity gal	Weight lbs	Model-No.	USD
						White - 00
<b>Bathtub</b>						
74 3/4"	35 1/2"	18 1/8"	60.0	158.7	<b>700012 00 0 00 0090</b>	<b>5,070</b>
<b>Bathtub inclusive whirlsystem</b>						
Air-System					<b>710012 00 1 00 1090</b>	7,900
Air-System with ozone					<b>710012 00 1 54 1090</b>	9,240
Air-System with remote					<b>710012 00 1 46 1090</b>	8,540
Air-System with remote and ozone					<b>710012 00 1 55 1090</b>	9,875
Air-System with remote and light					<b>710012 00 1 57 1090</b>	9,000
Air-System with remote, ozone and light					<b>710012 00 1 59 1090</b>	10,340
<b>Accessories for bath- and whirltub</b>						
Cable-driven waste and overflow, for central outlet, plastic, Chrome trim, (included)					<b>790238 00 0 00 1000</b>	<b>270</b>
Stereo transducers (speakers) for bathtubs and whirltubs					<b>791818 00 0 00 0000</b>	<b>1,750</b>

**Infobox:** Bathtubs are cUPC listed / Bathtubs with whirlsystem are cUPC and cIAPMO@ELECTRICAL listed

**Starck** Design by Philippe Starck

**Bathtub rectangle, built-in or for panel, with one backrest slope, cUPC listed**  
1/4" sanitary acrylic

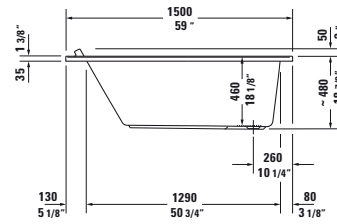
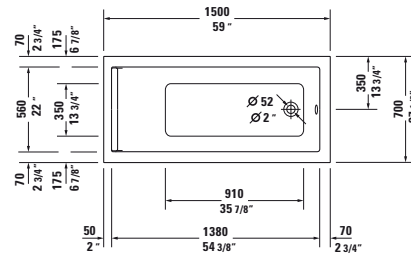

Length inch	Width inch	Depth/Height inch	Capacity gal	Weight lbs	Model-No.	USD
						White - 00
<b>Bathtub</b>						
59"	27 1/2"	18 1/8"	52.123	52.9	<b>700331 00 0 00 0090</b>	<b>960</b>
<b>Bathtub inclusive whirlsystem</b>						
					<b>710331 00 1 00 1090</b>	3,045
					<b>710331 00 2 00 1090</b>	3,045
					<b>710331 00 2 50 1090</b>	3,435
					<b>710331 00 2 51 1090</b>	4,670
					<b>710331 00 3 00 1090</b>	4,160
					<b>710331 00 3 50 1090</b>	4,545
					<b>710331 00 3 51 1090</b>	5,775
					<b>710331 00 4 00 1090</b>	4,630
					<b>710331 00 4 50 1090</b>	5,020
					<b>710331 00 4 51 1090</b>	6,250
					<b>710331 00 1 46 1090</b>	3,630
					<b>710331 00 2 46 1090</b>	3,630
					<b>710331 00 2 52 1090</b>	3,435
					<b>710331 00 2 53 1090</b>	5,250
					<b>710331 00 3 46 1090</b>	4,750
					<b>710331 00 3 52 1090</b>	5,145
					<b>710331 00 3 53 1090</b>	6,370
					<b>710331 00 4 46 1090</b>	5,210
					<b>710331 00 4 52 1090</b>	5,605
					<b>710331 00 4 53 1090</b>	6,835
<b>Accessories for bath- and whirltub</b>						
					<b>790010 00 0 00 0000</b>	<b>120</b>
					<b>790220 00 0 00 1000</b>	<b>200</b>
					<b>790112 00 0 00 0000</b>	<b>225</b>
					<b>790108 00 0 00 0000</b>	<b>160</b>
					<b>790103 00 0 00 0000</b>	<b>65</b>
					<b>791818 00 0 00 0000</b>	1,750
<b>Accessories for Bathtub</b>						
Suitable tub covers see page 538 - 539						

**Infobox:** Bathtubs are cUPC listed / Bathtubs with whirlsystem are cUPC and cIAPMO®ELECTRICAL listed

**Starck** Design by Philippe Starck

**Bathtub rectangle, built-in or for panel, with one backrest slope, cUPC listed**  
1/4" sanitary acrylic

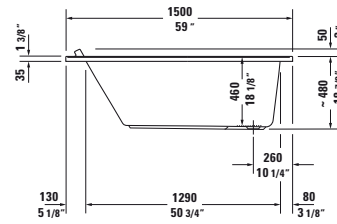
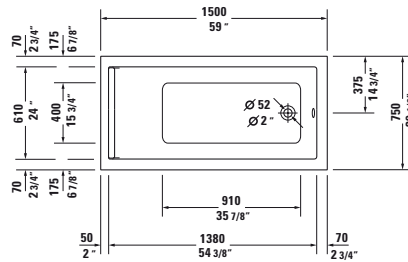

Length inch	Width inch	Depth/Height inch	Capacity gal	Weight lbs	Model-No.	USD
						White - 00
<b>Bathtub</b>						
59"	29 1/2"	18 1/8"	56.8	54.0	<b>700332 00 0 00 0090</b>	<b>1,045</b>
<b>Bathtub inclusive whirlsystem</b>						
					<b>710332 00 1 00 1090</b>	3,305
					<b>710332 00 2 00 1090</b>	3,305
					<b>710332 00 2 50 1090</b>	4,290
					<b>710332 00 2 51 1090</b>	5,020
					<b>710332 00 3 00 1090</b>	4,500
					<b>710332 00 3 50 1090</b>	4,900
					<b>710332 00 3 51 1090</b>	6,190
					<b>710332 00 4 00 1090</b>	4,980
					<b>710332 00 4 50 1090</b>	5,390
					<b>710332 00 4 51 1090</b>	6,675
					<b>710332 00 1 46 1090</b>	3,915
					<b>710332 00 2 46 1090</b>	3,915
					<b>710332 00 2 52 1090</b>	4,325
					<b>710332 00 2 53 1090</b>	5,645
					<b>710332 00 3 46 1090</b>	5,075
					<b>710332 00 3 52 1090</b>	5,505
					<b>710332 00 3 53 1090</b>	6,790
					<b>710332 00 4 46 1090</b>	5,580
					<b>710332 00 4 52 1090</b>	5,995
					<b>710332 00 4 53 1090</b>	7,320
<b>Accessories for bath- and whirltub</b>						
					<b>790010 00 0 00 0000</b>	<b>120</b>
					<b>790220 00 0 00 1000</b>	<b>200</b>
					<b>790112 00 0 00 0000</b>	<b>225</b>
					<b>790108 00 0 00 0000</b>	<b>160</b>
					<b>790103 00 0 00 0000</b>	<b>65</b>
					<b>791818 00 0 00 0000</b>	1,750
<b>Accessories for Bathtub</b>						
Suitable tub covers see page 538 - 539						

**Infobox:** Bathtubs are cUPC listed / Bathtubs with whirlsystem are cUPC and ciAPMO®ELECTRICAL listed

**Starck** Design by Philippe Starck

**Bathtub rectangle, built-in or for panel, with one backrest slope, cUPC listed**  
1/4" sanitary acrylic

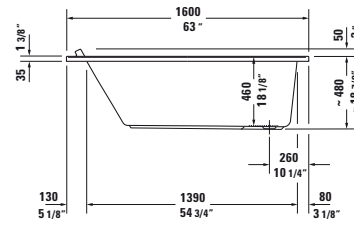
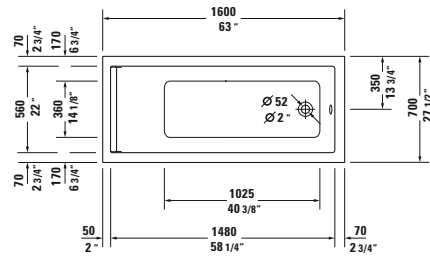

Length inch	Width inch	Depth/Height inch	Capacity gal	Weight lbs	Model-No.	USD
						White - 00
<b>Bathtub</b>						
63"	27 1/2"	18 1/8"	55.5	57.4	<b>700333 00 0 00 0090</b>	1,125
<b>Bathtub inclusive whirlsystem</b>						
					<b>710333 00 1 00 1090</b>	3,360
					<b>710333 00 2 00 1090</b>	3,360
					<b>710333 00 2 50 1090</b>	3,790
					<b>710333 00 2 51 1090</b>	5,075
					<b>710333 00 3 00 1090</b>	4,505
					<b>710333 00 3 50 1090</b>	4,960
					<b>710333 00 3 51 1090</b>	6,245
					<b>710333 00 4 00 1090</b>	5,045
					<b>710333 00 4 50 1090</b>	5,450
					<b>710333 00 4 51 1090</b>	6,750
					<b>710333 00 1 46 1090</b>	3,990
					<b>710333 00 2 46 1090</b>	3,990
					<b>710333 00 2 52 1090</b>	4,390
					<b>710333 00 2 53 1090</b>	5,650
					<b>710333 00 3 46 1090</b>	5,170
					<b>710333 00 3 52 1090</b>	5,570
					<b>710333 00 3 53 1090</b>	6,795
					<b>710333 00 4 46 1090</b>	5,650
					<b>710333 00 4 52 1090</b>	6,070
					<b>710333 00 4 53 1090</b>	7,360
<b>Accessories for bath- and whirltub</b>						
					<b>790010 00 0 00 0000</b>	120
					<b>790220 00 0 00 1000</b>	200
					<b>790112 00 0 00 0000</b>	225
					<b>790108 00 0 00 0000</b>	160
					<b>790103 00 0 00 0000</b>	65
					<b>791818 00 0 00 0000</b>	1,750
Suitable panels see page 490 - 491						

**Accessories for Bathtub**  
Suitable tub covers see page 538 - 539

**Infobox:** Bathtubs are cUPC listed / Bathtubs with whirlsystem are cUPC and cIAPMO®ELECTRICAL listed



**Starck** Design by Philippe Starck

**Bathtub rectangle, built-in or for panel, with one backrest slope, cUPC listed**  
1/4" sanitary acrylic

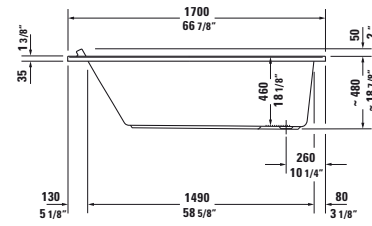
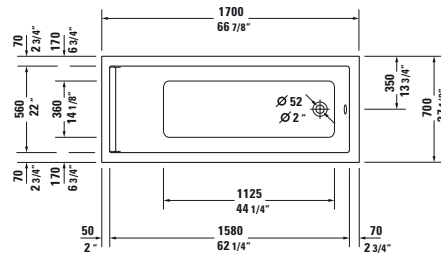

Length inch	Width inch	Depth/Height inch	Capacity gal	Weight lbs	Model-No.	USD
						White - 00
<b>Bathtub</b>						
66 7/8"	27 1/2"	18 1/8"	60.7	60.6	<b>700334 00 0 00 0090</b>	1,205
<b>Bathtub inclusive whirlsystem</b>						
					<b>710334 00 1 00 1090</b>	3,465
					<b>710334 00 2 00 1090</b>	3,465
					<b>710334 00 2 50 1090</b>	3,880
					<b>710334 00 2 51 1090</b>	5,160
					<b>710334 00 3 00 1090</b>	4,700
					<b>710334 00 3 50 1090</b>	5,105
					<b>710334 00 3 51 1090</b>	6,400
					<b>710334 00 4 00 1090</b>	5,195
					<b>710334 00 4 50 1090</b>	5,605
					<b>710334 00 4 51 1090</b>	6,905
					<b>710334 00 1 46 1090</b>	4,080
					<b>710334 00 2 46 1090</b>	4,080
					<b>710334 00 2 52 1090</b>	4,470
					<b>710334 00 2 53 1090</b>	5,765
					<b>710334 00 3 46 1090</b>	5,310
					<b>710334 00 3 52 1090</b>	5,725
					<b>710334 00 3 53 1090</b>	7,015
					<b>710334 00 4 46 1090</b>	5,820
					<b>710334 00 4 52 1090</b>	6,215
					<b>710334 00 4 53 1090</b>	7,520
<b>Accessories for bath- and whirltub</b>						
					<b>790010 00 0 00 0000</b>	120
					<b>790220 00 0 00 1000</b>	200
					<b>790112 00 0 00 0000</b>	225
					<b>790108 00 0 00 0000</b>	160
					<b>790103 00 0 00 0000</b>	65
					<b>791818 00 0 00 0000</b>	1,750
Stereo transducers (speakers) for bathtubs and whirltubs						
Suitable panels see page 490 - 491						

**Accessories for Bathtub**  
Suitable tub covers see page 538 - 539

**Infobox:** Bathtubs are cUPC listed / Bathtubs with whirlsystem are cUPC and cIAPMO®ELECTRICAL listed

**Starck** Design by Philippe Starck

**Bathtub rectangle, built-in or for panel, with one backrest slope, cUPC listed**  
1/4" sanitary acrylic

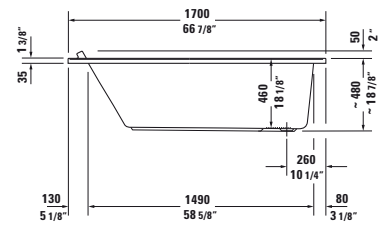
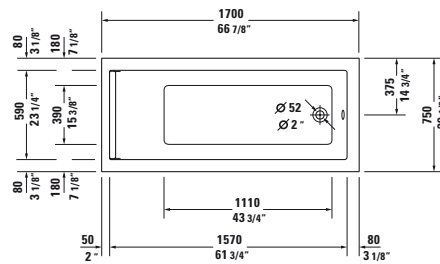

Length inch	Width inch	Depth/Height inch	Capacity gal	Weight lbs	Model-No.	USD
						White - 00
<b>Bathtub</b>						
66 7/8"	29 1/2"	18 1/8"	63.0	63.9	<b>700335 00 0 00 0090</b>	1,285
<b>Bathtub inclusive whirlsystem</b>						
Air-System					<b>710335 00 1 00 1090</b>	3,545
Jet-System					<b>710335 00 2 00 1090</b>	3,545
Jet-System with heater					<b>710335 00 2 50 1090</b>	3,955
Jet-System with heater and ozone					<b>710335 00 2 51 1090</b>	5,235
Combi-System					<b>710335 00 3 00 1090</b>	4,785
Combi-System with heater					<b>710335 00 3 50 1090</b>	5,185
Combi-System with heater and ozone					<b>710335 00 3 51 1090</b>	6,480
Combi-System with light					<b>710335 00 4 00 1090</b>	5,280
Combi-System with light and heater					<b>710335 00 4 50 1090</b>	5,690
Combi-System with light, heater and ozone					<b>710335 00 4 51 1090</b>	6,985
Air-System with remote					<b>710335 00 1 46 1090</b>	4,160
Jet-System with remote					<b>710335 00 2 46 1090</b>	4,160
Jet-System with remote and heater					<b>710335 00 2 52 1090</b>	4,555
Jet-System with remote, heater and ozone					<b>710335 00 2 53 1090</b>	5,850
Combi-System with remote					<b>710335 00 3 46 1090</b>	5,385
Combi-System with remote and heater					<b>710335 00 3 52 1090</b>	5,810
Combi-System with remote, heater and ozone					<b>710335 00 3 53 1090</b>	7,100
Combi-System with light and remote					<b>710335 00 4 46 1090</b>	5,895
Combi-System with light, remote and heater					<b>710335 00 4 52 1090</b>	6,290
Combi-System with light, remote, heater and ozone					<b>710335 00 4 53 1090</b>	7,600
<b>Accessories for bath- and whirltub</b>						
Headrest, White					<b>790010 00 0 00 0000</b>	120
Cable-driven waste and overflow, plastic, Chrome trim					<b>790220 00 0 00 1000</b>	200
Tile flange					<b>790112 00 0 00 0000</b>	225
Support frame, (included)					<b>790108 00 0 00 0000</b>	160
Bathtub anchors					<b>790103 00 0 00 0000</b>	65
Stereo transducers (speakers) for bathtubs and whirltubs					<b>791818 00 0 00 0000</b>	1,750
Suitable panels see page 490 - 491						

**Accessories for Bathtub**  
Suitable tub covers see page 538 - 539

**Infobox:** Bathtubs are cUPC listed / Bathtubs with whirlsystem are cUPC and ciAPMO®ELECTRICAL listed

**Starck** Design by Philippe Starck

**Bathtub rectangle, built-in or for panel, with one backrest slope, cUPC listed**  
1/4" sanitary acrylic

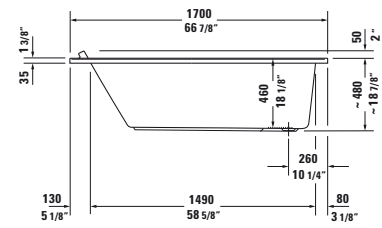
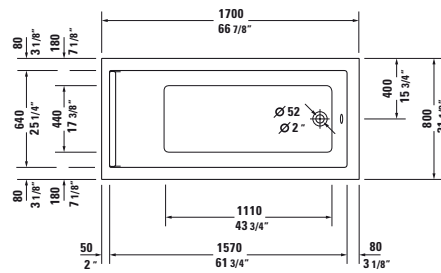

Length inch	Width inch	Depth/Height inch	Capacity gal	Weight lbs	Model-No.	USD
						White - 00
<b>Bathtub</b>						
66 7/8"	31 1/2"	18 1/8"	68.0	65.0	<b>700336 00 0 00 0090</b>	<b>1,370</b>
<b>Bathtub inclusive whirlsystem</b>						
Air-System					<b>710336 00 1 00 1090</b>	3,425
Jet-System					<b>710336 00 2 00 1090</b>	3,425
Jet-System with heater					<b>710336 00 2 50 1090</b>	3,865
Jet-System with heater and ozone					<b>710336 00 2 51 1090</b>	5,150
Combi-System					<b>710336 00 3 00 1090</b>	4,575
Combi-System with heater					<b>710336 00 3 50 1090</b>	5,095
Combi-System with heater and ozone					<b>710336 00 3 51 1090</b>	6,385
Combi-System with light					<b>710336 00 4 00 1090</b>	5,355
Combi-System with light and heater					<b>710336 00 4 50 1090</b>	5,720
Combi-System with light, heater and ozone					<b>710336 00 4 51 1090</b>	7,065
Air-System with remote					<b>710336 00 1 46 1090</b>	4,060
Jet-System with remote					<b>710336 00 2 46 1090</b>	4,060
Jet-System with remote and heater					<b>710336 00 2 52 1090</b>	4,455
Jet-System with remote, heater and ozone					<b>710336 00 2 53 1090</b>	5,720
Combi-System with remote					<b>710336 00 3 46 1090</b>	5,300
Combi-System with remote and heater					<b>710336 00 3 52 1090</b>	5,375
Combi-System with remote, heater and ozone					<b>710336 00 3 53 1090</b>	6,990
Combi-System with light and remote					<b>710336 00 4 46 1090</b>	5,970
Combi-System with light, remote and heater					<b>710336 00 4 52 1090</b>	6,385
Combi-System with light, remote, heater and ozone					<b>710336 00 4 53 1090</b>	7,670
<b>Accessories for bath- and whirltub</b>						
Headrest, White					<b>790010 00 0 00 0000</b>	<b>120</b>
Cable-driven waste and overflow, plastic, Chrome trim					<b>790220 00 0 00 1000</b>	<b>200</b>
Tile flange					<b>790112 00 0 00 0000</b>	<b>225</b>
Support frame, (included)					<b>790108 00 0 00 0000</b>	<b>160</b>
Bathtub anchors					<b>790103 00 0 00 0000</b>	<b>65</b>
Stereo transducers (speakers) for bathtubs and whirltubs					<b>791818 00 0 00 0000</b>	<b>1,750</b>
Suitable panels see page 490 - 491						

**Accessories for Bathtub**  
Suitable tub covers see page 538 - 539

**Infobox:** Bathtubs are cUPC listed / Bathtubs with whirlsystem are cUPC and cIAPMO®ELECTRICAL listed

**Starck** Design by Philippe Starck

**Bathtub rectangle, built-in or for panel, with one backrest slope, cUPC listed**  
1/4" sanitary acrylic

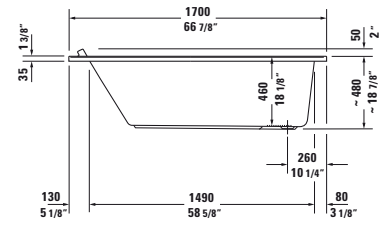
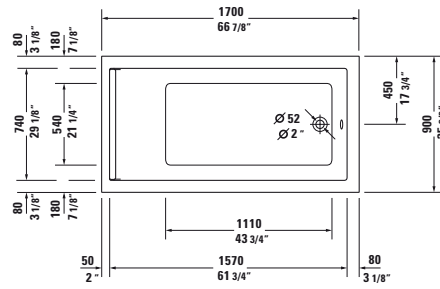

Length inch	Width inch	Depth/Height inch	Capacity gal	Weight lbs	Model-No.	USD
						White - 00
<b>Bathtub</b>						
66 7/8"	35 3/8"	18 1/8"	78.2	73.8	700337 00 0 00 0090	1,445
<b>Bathtub inclusive whirlsystem</b>						
					710337 00 1 00 1090	3,570
					710337 00 2 00 1090	3,570
					710337 00 2 50 1090	3,940
					710337 00 2 51 1090	5,220
					710337 00 3 00 1090	4,760
					710337 00 3 50 1090	5,170
					710337 00 3 51 1090	6,465
					710337 00 4 00 1090	5,450
					710337 00 4 50 1090	5,865
					710337 00 4 51 1090	7,140
					710337 00 1 46 1090	4,125
					710337 00 2 46 1090	4,125
					710337 00 2 52 1090	4,545
					710337 00 2 53 1090	5,880
					710337 00 3 46 1090	5,360
					710337 00 3 52 1090	5,740
					710337 00 3 53 1090	7,105
					710337 00 4 46 1090	6,035
					710337 00 4 52 1090	6,465
					710337 00 4 53 1090	7,790
<b>Accessories for bath- and whirltub</b>						
					790010 00 0 00 0000	120
					790220 00 0 00 1000	200
					790112 00 0 00 0000	225
					790108 00 0 00 0000	160
					790103 00 0 00 0000	65
					791818 00 0 00 0000	1,750
Suitable panels see page 490 - 491						
<b>Accessories for Bathtub</b>						
Suitable tub covers see page 538 - 539						

**Infobox:** Bathtubs are cUPC listed / Bathtubs with whirlsystem are cUPC and cIAPMO®ELECTRICAL listed

**Starck** Design by Philippe Starck

**Bathtub rectangle, built-in or for panel, with two backrest slopes, cUPC listed**  
1/4" sanitary acrylic

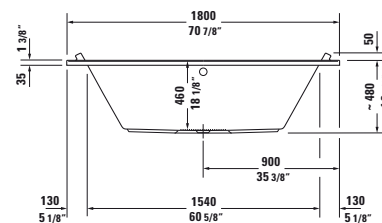
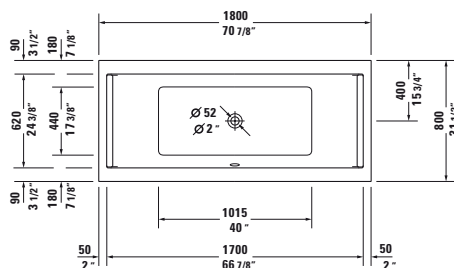

Length inch	Width inch	Depth/Height inch	Capacity gal	Weight lbs	Model-No.	USD
						White - 00
<b>Bathtub</b>						
70 7/8"	31 1/2"	18 1/8"	65.8	69.5	<b>700338 00 0 00 0090</b>	<b>1,530</b>
<b>Bathtub inclusive whirlsystem</b>						
Air-System					<b>710338 00 1 00 1090</b>	3,665
Jet-System					<b>710338 00 2 00 1090</b>	3,665
Jet-System with heater					<b>710338 00 2 50 1090</b>	4,075
Jet-System with heater and ozone					<b>710338 00 2 51 1090</b>	5,365
Combi-System					<b>710338 00 3 00 1090</b>	4,890
Combi-System with heater					<b>710338 00 3 50 1090</b>	5,310
Combi-System with heater and ozone					<b>710338 00 3 51 1090</b>	6,605
Combi-System with light					<b>710338 00 4 00 1090</b>	5,385
Combi-System with light and heater					<b>710338 00 4 50 1090</b>	5,800
Combi-System with light, heater and ozone					<b>710338 00 4 51 1090</b>	7,100
Air-System with remote					<b>710338 00 1 46 1090</b>	4,285
Jet-System with remote					<b>710338 00 2 46 1090</b>	4,285
Jet-System with remote, heater and ozone					<b>710338 00 2 52 1090</b>	4,685
Combi-System with remote					<b>710338 00 3 46 1090</b>	5,515
Combi-System with remote and heater					<b>710338 00 3 52 1090</b>	5,920
Combi-System with remote, heater and ozone					<b>710338 00 3 53 1090</b>	7,225
Combi-System with light and remote					<b>710338 00 4 46 1090</b>	6,005
Combi-System with light, remote and heater					<b>710338 00 4 52 1090</b>	6,420
Combi-System with light, remote, heater and ozone					<b>710338 00 4 53 1090</b>	7,715
<b>Accessories for bath- and whirltub</b>						
Headrest, White					<b>790010 00 0 00 0000</b>	120
Cable-driven waste and overflow, plastic, Chrome trim					<b>790219 00 0 00 1000</b>	225
Tile flange					<b>790112 00 0 00 0000</b>	225
Support frame, (included)					<b>790108 00 0 00 0000</b>	160
Bathtub anchors					<b>790103 00 0 00 0000</b>	65
Stereo transducers (speakers) for bathtubs and whirltubs					<b>791818 00 0 00 0000</b>	1,750
Suitable panels see page 490 - 491						
<b>Accessories for Bathtub</b>						
Suitable tub covers see page 538 - 539						

**Infobox:** Bathtubs are cUPC listed / Bathtubs with whirlsystem are cUPC and cIAPMO@ELECTRICAL listed

**Starck** Design by Philippe Starck

**Bathtub rectangle, built-in or for panel, with two backrest slopes, cUPC listed**  
1/4" sanitary acrylic

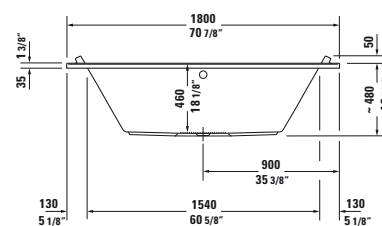
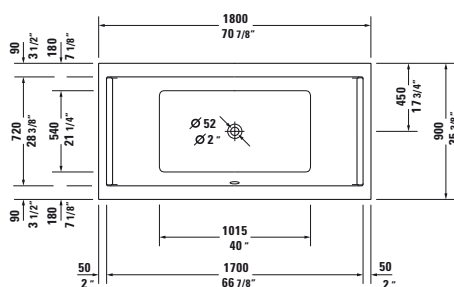

Length inch	Width inch	Depth/Height inch	Capacity gal	Weight lbs	Model-No.	USD
						White - 00
<b>Bathtub</b>						
70 7/8"	35 3/8"	18 1/8"	75.8	71.7	<b>700339 00 0 00 0090</b>	<b>1,605</b>
<b>Bathtub inclusive whirlsystem</b>						
Air-System					<b>710339 00 1 00 1090</b>	3,745
Jet-System					<b>710339 00 2 00 1090</b>	3,745
Jet-System with heater					<b>710339 00 2 50 1090</b>	4,155
Jet-System with heater and ozone					<b>710339 00 2 51 1090</b>	5,450
Combi-System					<b>710339 00 3 00 1090</b>	4,970
Combi-System with heater					<b>710339 00 3 50 1090</b>	5,385
Combi-System with heater and ozone					<b>710339 00 3 51 1090</b>	6,680
Combi-System with light					<b>710339 00 4 00 1090</b>	5,470
Combi-System with light and heater					<b>710339 00 4 50 1090</b>	5,880
Combi-System with light, heater and ozone					<b>710339 00 4 51 1090</b>	7,175
Air-System with remote					<b>710339 00 1 46 1090</b>	4,365
Jet-System with remote					<b>710339 00 2 46 1090</b>	4,365
Jet-System with remote and heater					<b>710339 00 2 52 1090</b>	4,770
Jet-System with remote, heater and ozone					<b>710339 00 2 53 1090</b>	6,065
Combi-System with remote					<b>710339 00 3 46 1090</b>	5,595
Combi-System with remote and heater					<b>710339 00 3 52 1090</b>	6,000
Combi-System with remote, heater and ozone					<b>710339 00 3 53 1090</b>	7,305
Combi-System with light and remote					<b>710339 00 4 46 1090</b>	6,085
Combi-System with light, remote and heater					<b>710339 00 4 52 1090</b>	6,500
Combi-System with light, remote, heater and ozone					<b>710339 00 4 53 1090</b>	7,800
<b>Accessories for bath- and whirltub</b>						
Headrest, White					<b>790010 00 0 00 0000</b>	<b>120</b>
Cable-driven waste and overflow, plastic, Chrome trim					<b>790219 00 0 00 1000</b>	<b>225</b>
Tile flange					<b>790112 00 0 00 0000</b>	<b>225</b>
Support frame, (included)					<b>790108 00 0 00 0000</b>	<b>160</b>
Bathtub anchors					<b>790103 00 0 00 0000</b>	<b>65</b>
Stereo transducers (speakers) for bathtubs and whirltubs					<b>791818 00 0 00 0000</b>	<b>1,750</b>
Suitable panels see page 490 - 491						

**InfoBox:** Bathtubs are cUPC listed / Bathtubs with whirlsystem are cUPC and cIAPMO®ELECTRICAL listed

**Starck** Design by Philippe Starck

**Bathtub rectangle, built-in or for panel, with two backrest slopes, cUPC listed**  
1/4" sanitary acrylic

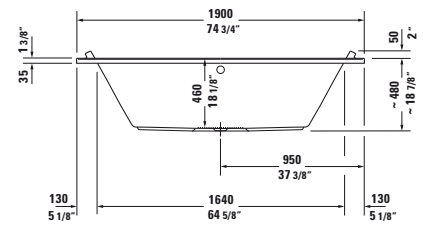
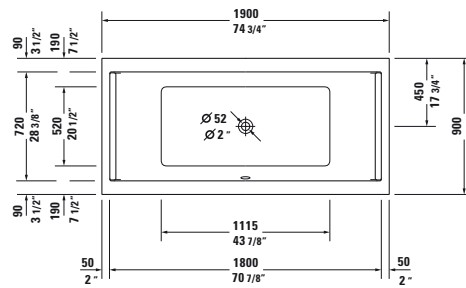

Length inch	Width inch	Depth/Height inch	Capacity gal	Weight lbs	Model-No.	USD
						White - 00
<b>Bathtub</b>						
74 3/4"	35 3/8"	18 1/8"	83.5	74.1	<b>700340 00 0 00 0090</b>	<b>1,685</b>
<b>Bathtub inclusive whirlsystem</b>						
Air-System					<b>710340 00 1 00 1090</b>	3,765
Jet-System					<b>710340 00 2 00 1090</b>	3,765
Jet-System with heater					<b>710340 00 2 50 1090</b>	4,180
Jet-System with heater and ozone					<b>710340 00 2 51 1090</b>	5,475
Combi-System					<b>710340 00 3 00 1090</b>	4,880
Combi-System with heater					<b>710340 00 3 50 1090</b>	5,295
Combi-System with heater and ozone					<b>710340 00 3 51 1090</b>	6,580
Combi-System with light					<b>710340 00 4 00 1090</b>	5,370
Combi-System with light and heater					<b>710340 00 4 50 1090</b>	5,780
Combi-System with light, heater and ozone					<b>710340 00 4 51 1090</b>	7,070
Air-System with remote					<b>710340 00 1 46 1090</b>	4,595
Jet-System with remote					<b>710340 00 2 46 1090</b>	4,385
Jet-System with remote and heater					<b>710340 00 2 52 1090</b>	4,180
Jet-System with remote, heater and ozone					<b>710340 00 2 53 1090</b>	6,100
Combi-System with remote					<b>710340 00 3 46 1090</b>	5,495
Combi-System with remote and heater					<b>710340 00 3 52 1090</b>	5,905
Combi-System with remote, heater and ozone					<b>710340 00 3 53 1090</b>	7,195
Combi-System with light and remote					<b>710340 00 4 46 1090</b>	5,995
Combi-System with light, remote and heater					<b>710340 00 4 52 1090</b>	6,405
Combi-System with light, remote, heater and ozone					<b>710340 00 4 53 1090</b>	7,680
<b>Accessories for bath- and whirltub</b>						
Headrest, White					<b>790010 00 0 00 0000</b>	<b>120</b>
Cable-driven waste and overflow, plastic, Chrome trim					<b>790219 00 0 00 1000</b>	<b>225</b>
Tile flange					<b>790112 00 0 00 0000</b>	<b>225</b>
Support frame, (included)					<b>790108 00 0 00 0000</b>	<b>160</b>
Bathtub anchors					<b>790103 00 0 00 0000</b>	<b>65</b>
Stereo transducers (speakers) for bathtubs and whirltubs					<b>791818 00 0 00 0000</b>	<b>1,750</b>
Suitable panels see page 490 - 491						

**Infobox:** Bathtubs are cUPC listed / Bathtubs with whirlsystem are cUPC and cIAPMO®ELECTRICAL listed

**Starck** Design by Philippe Starck

**Bathtub rectangle, built-in or for panel, with two backrest slopes, cUPC listed**  
1/4" sanitary acrylic

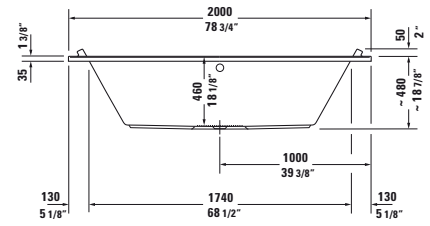
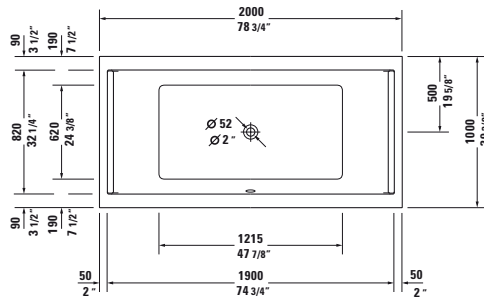



Length inch	Width inch	Depth/Height inch	Capacity gal	Weight lbs	Model-No.	USD
						White - 00
<b>Bathtub</b>						
78 3/4"	39 3/8"	18 1/8"	101.4	87.1	<b>700341 00 0 00 0090</b>	1,770
<b>Bathtub inclusive whirlsystem</b>						
Air-System					<b>710341 00 1 00 1090</b>	3,980
Jet-System					<b>710341 00 2 00 1090</b>	3,980
Jet-System with heater					<b>710341 00 2 50 1090</b>	4,395
Jet-System with heater and ozone					<b>710341 00 2 51 1090</b>	5,690
Combi-System					<b>710341 00 3 00 1090</b>	5,310
Combi-System with heater					<b>710341 00 3 50 1090</b>	5,720
Combi-System with heater and ozone					<b>710341 00 3 51 1090</b>	7,020
Combi-System with light					<b>710341 00 4 00 1090</b>	5,800
Combi-System with light and heater					<b>710341 00 4 50 1090</b>	6,215
Combi-System with light, heater and ozone					<b>710341 00 4 51 1090</b>	7,455
Air-System with remote					<b>710341 00 1 46 1090</b>	4,595
Jet-System with remote					<b>710341 00 2 46 1090</b>	5,635
Jet-System with remote and heater					<b>710341 00 2 52 1090</b>	5,010
Jet-System with remote, heater and ozone					<b>710341 00 2 53 1090</b>	6,290
Combi-System with remote					<b>710341 00 3 46 1090</b>	5,930
Combi-System with remote and heater					<b>710341 00 3 52 1090</b>	6,290
Combi-System with remote, heater and ozone					<b>710341 00 3 53 1090</b>	7,630
Combi-System with light and remote					<b>710341 00 4 46 1090</b>	6,415
Combi-System with light, remote and heater					<b>710341 00 4 52 1090</b>	6,820
Combi-System with light, remote, heater and ozone					<b>710341 00 4 53 1090</b>	8,110
<b>Accessories for bath- and whirltub</b>						
Headrest, White					<b>790010 00 0 00 0000</b>	120
Cable-driven waste and overflow, plastic, Chrome trim					<b>790219 00 0 00 1000</b>	225
Tile flange					<b>790112 00 0 00 0000</b>	225
Support frame, (included)					<b>790111 00 0 00 0000</b>	160
Bathtub anchors					<b>790103 00 0 00 0000</b>	65
Stereo transducers (speakers) for bathtubs and whirltubs					<b>791818 00 0 00 0000</b>	1,750
Suitable panels see page 490 - 491						

**InfoBox:** Bathtubs are cUPC listed / Bathtubs with whirlsystem are cUPC and cIAPMO®ELECTRICAL listed



**Starck Accessories** Design by Philippe Starck

Description	Model-No.	USD
 <b>Headrest</b> for Starck, material: polyurethane White	790010 00 0 00 0000	120
 <b>Acrylic panel</b> front, for Starck bath- and whirltubs	59" 701065 00 0 00 0000 63" 701066 00 0 00 0000 67" 701067 00 0 00 0000 70 7/8" 701068 00 0 00 0000 74 3/4" 701069 00 0 00 0000 78 3/4" 701070 00 0 00 0000	440 440 485 500 530 555
 <b>Acrylic panel</b> sidewise, for Starck bath- and whirltubs	27 1/2" 701071 00 0 00 0000 29 1/2" 701072 00 0 00 0000 31 1/2" 701073 00 0 00 0000 35 3/8" 701074 00 0 00 0000 39 3/8" 701075 00 0 00 0000	310 310 370 380 400

**Starck** Design by Philippe Starck

**Product Information**

<b>Panel</b>	<b>Decor</b>	<b>14</b> Terra <b>31</b> Pine Silver <b>43</b> Basalt Matt <b>49</b> Graphite Matt <b>51</b> Pine Terra <b>52</b> European Oak <b>53</b> Chestnut Dark <b>73</b> Ticino Cherry Tree <b>79</b> Natural Walnut	<b>Basic material:</b> High-density-fiberboard, with laminate (HPL) pressed on both sides.
	<b>Pricegroup 1</b>		
	<b>Acryl</b>	<b>82</b> Acrylic White	<b>Basic material:</b> 3/8" Acryl solid-colored in white
	<b>Pricegroup 1</b>		
	<b>Real wood veneer</b>	<b>13</b> American Walnut <b>24</b> Macassar <b>26</b> American Cherry Tree	<b>Basic material:</b> High-density-fiberboard, with real wood veneer pressed on one side and laminate (HPL) pressed on other side.  Real wood veneer is a natural material, differences in color and structure may occur.
	<b>Pricegroup 2</b>		
	<b>Real wood veneer</b>	<b>05</b> Oak <b>12</b> Brushed Oak <b>69</b> Brushed Walnut <b>71</b> Mediterranean Oak <b>72</b> Brushed Dark Oak	<b>Basic material:</b> High-density-fiberboard, with real wood veneer pressed on one side and laminate (HPL) pressed on other side.  Real wood veneer is a natural material, differences in color and structure may occur.
	<b>Pricegroup 3</b>		

**Starck** Design by Philippe Starck

Description	inch	Model-No.	USD			
			Pricegroup 1	Pricegroup 2	Pricegroup 3	
<b>Panel</b>						
for corner left						
for # 7X0331 (59" x 27 1/2")	27 1/8" x 58 5/8"	<b>ST 8908</b>	1,225	1,665	1,935	
for # 7X0332 (59" x 29 1/2")	29 1/8" x 58 5/8"	<b>ST 8909</b>	1,225	1,665	1,935	
for # 7X0333 (63" x 27 1/2")	27 1/8" x 62 5/8"	<b>ST 8785</b>	1,225	1,665	1,935	
for # 7X0334 (66 7/8" x 27 1/2")	27 1/8" x 66 1/2"	<b>ST 8786</b>	1,225	1,665	1,935	
for # 7X0335 (66 7/8" x 29 1/2")	29 1/8" x 66 1/2"	<b>ST 8787</b>	1,225	1,665	1,935	
for # 7X0336 (66 7/8" x 31 1/2")	31 1/8" x 66 1/2"	<b>ST 8910</b>	1,225	1,665	1,935	
for # 7X0337 (66 7/8" x 35 3/8")	35" x 66 1/2"	<b>ST 8911</b>	1,225	1,665	1,935	
for # 7X0338 (70 7/8" x 31 1/2")	31 1/8" x 70 1/2"	<b>ST 8788</b>	1,225	1,665	1,935	
for # 7X0339 (70 7/8" x 35 3/8")	35" x 70 1/2"	<b>ST 8912</b>	1,225	1,665	1,935	
for # 7X0340 (74 3/4" x 35 3/8")	35" x 74 3/4"	<b>ST 8906</b>	1,295	1,760	2,055	
for # 7X0341 (78 3/4" x 39 3/8")	39" x 78 3/8"	<b>ST 8907</b>	1,295	1,760	2,055	

**Infobox:** The included support frame is required for the installation of the panel / Heights of Starck series: Height bathtub panel = 21 7/8", height bathtub panel incl. 3/8" shadow gap = 22 1/4", overall height incl. bathtub rim 1 3/8" = 23 5/8"

<b>Panel</b>						
for corner right						
for # 7X0331 (59" x 27 1/2")	27 1/8" x 58 5/8"	<b>ST 8915</b>	1,225	1,665	1,935	
for # 7X0332 (59" x 29 1/2")	29 1/8" x 58 5/8"	<b>ST 8916</b>	1,225	1,665	1,935	
for # 7X0333 (63" x 27 1/2")	27 1/8" x 62 5/8"	<b>ST 8780</b>	1,225	1,665	1,935	
for # 7X0334 (66 7/8" x 27 1/2")	27 1/8" x 66 1/2"	<b>ST 8781</b>	1,225	1,665	1,935	
for # 7X0335 (66 7/8" x 29 1/2")	29 1/8" x 66 1/2"	<b>ST 8782</b>	1,225	1,665	1,935	
for # 7X0336 (66 7/8" x 31 1/2")	31 1/8" x 66 1/2"	<b>ST 8917</b>	1,225	1,665	1,935	
for # 7X0337 (66 7/8" x 35 3/8")	35" x 66 1/2"	<b>ST 8918</b>	1,225	1,665	1,935	
for # 7X0338 (70 7/8" x 31 1/2")	31 1/8" x 70 1/2"	<b>ST 8783</b>	1,225	1,665	1,935	
for # 7X0339 (70 7/8" x 35 3/8")	35" x 70 1/2"	<b>ST 8919</b>	1,225	1,665	1,935	
for # 7X0340 (74 3/4" x 35 3/8")	35" x 74 3/8"	<b>ST 8904</b>	1,295	1,760	2,055	
for # 7X0341 (78 3/4" x 39 3/8")	39" x 78 3/8"	<b>ST 8905</b>	1,295	1,760	2,055	

**Infobox:** The included support frame is required for the installation of the panel / Heights of Starck series: Height bathtub panel = 21 7/8", height bathtub panel incl. 3/8" shadow gap = 22 1/4", overall height incl. bathtub rim 1 3/8" = 23 5/8"

<b>Panel</b>						
for back-to-wall						
for # 7X0331 (59" x 27 1/2")	29 1/8" x 58 1/4"	<b>ST 8922</b>	1,595	1,925	2,205	
for # 7X0332 (59" x 29 1/2")	29 1/8" x 58 1/4"	<b>ST 8923</b>	1,595	1,925	2,205	
for # 7X0333 (63" x 27 1/2")	27 1/8" x 62 1/4"	<b>ST 8775</b>	1,595	1,925	2,205	
for # 7X0334 (66 7/8" x 27 1/2")	27 1/8" x 66 1/8"	<b>ST 8776</b>	1,595	1,925	2,205	
for # 7X0335 (66 7/8" x 29 1/2")	29 1/8" x 66 1/8"	<b>ST 8777</b>	1,595	1,925	2,205	
for # 7X0336 (66 7/8" x 31 1/2")	31 1/8" x 66 1/8"	<b>ST 8924</b>	1,595	1,925	2,205	
for # 7X0337 (66 7/8" x 35 3/8")	35" x 66 1/8"	<b>ST 8925</b>	1,595	1,925	2,205	
for # 7X0338 (70 7/8" x 31 1/2")	31 1/8" x 70 1/8"	<b>ST 8778</b>	1,595	1,925	2,205	
for # 7X0339 (70 7/8" x 35 3/8")	35" x 70 1/8"	<b>ST 8926</b>	1,595	1,925	2,205	
for # 7X0340 (74 3/4" x 35 3/8")	35" x 74"	<b>ST 8902</b>	1,680	2,020	2,310	
for # 7X0341 (78 3/4" x 39 3/8")	39" x 78"	<b>ST 8903</b>	1,680	2,020	2,310	

**Infobox:** The included support frame is required for the installation of the panel / Heights of Starck series: Height bathtub panel = 21 7/8", height bathtub panel incl. 3/8" shadow gap = 22 1/4", overall height incl. bathtub rim 1 3/8" = 23 5/8"

**Starck** Design by Philippe Starck

Description	inch	Model-No.	USD			
			Pricegroup 1	Pricegroup 2	Pricegroup 3	
						
<b>Panel</b>						
for niche (alcove)						
for # 7X0331 (59" x 27 1/2"),						
for # 7X0332 (59" x 29 1/2")	58 5/8"	<b>ST 8936</b>	965	1,210	1,305	
for # 7X0333 (63" x 27 1/2")	62 5/8"	<b>ST 8937</b>	965	1,210	1,305	
for # 7X0334 (66 7/8" x 27 1/2"),						
for # 7X0335 (66 7/8" x 29 1/2"),						
for # 7X0336 (66 7/8" x 31 1/2"),						
for # 7X0337 (66 7/8" x 35 3/8")	66 1/2"	<b>ST 8938</b>	965	1,210	1,305	
for # 7X0338 (70 7/8" x 31 1/2"),						
for # 7X0339 (70 7/8" x 35 3/8")	70 1/2"	<b>ST 8939</b>	965	1,210	1,305	
for # 7X0340 (74 3/4" x 35 3/8")	74 3/8"	<b>ST 8941</b>	990	1,240	1,335	
for # 7X0341 (78 3/4" x 39 3/8")	78 3/8"	<b>ST 8942</b>	990	1,240	1,335	

**Infobox:** The included support frame is required for the installation of the panel / Heights of Starck series: Height bathtub panel = 21 7/8", height bathtub panel incl. 3/8" shadow gap = 22 1/4", overall height incl. bathtub rim 1 3/8" = 23 5/8" / Panel # ST 8936 available from stock: 82-Acrylic White