

Ordering Sample

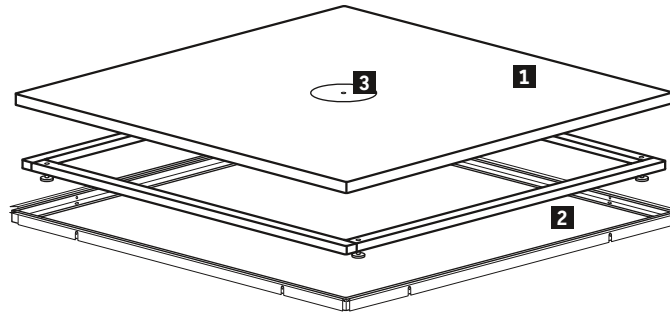

Description	Remark	Quantity	Model-No.
1 Flush Fitting Shower Tray	35 3/8" x 35 3/8"	1	# 720082 00 0 00 0090
2 Mounting set for # 720082 (border frame, support frame)		1	# 790140 00 0 00 0000
3 Outlet drain for Flush Fitting Shower Trays, horizontal outlet		1	# 790262 00 0 00 * *00

DuraPlan Design by Prof. Frank Huster

Flush-mounted shower tray square, cUPC listed
1/4" sanitary acrylic

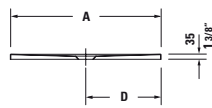
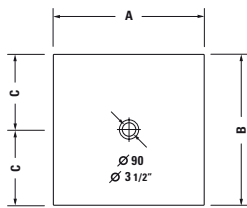

	A	B	C	D
720082	35 3/8"	35 3/8"	17 9/16"	17 9/16"
720082	893	893	446,5	446,5
720085	39 3/8"	39 3/8"	19 9/16"	19 9/16"
720085	993	993	496,5	496,5
720089	47 1/4"	47 1/4"	23 1/2"	23 1/2"
720089	1193	1193	596,5	596,5

Length inch	Width inch	Depth/Height inch	Weight lbs	Model-No.	USD
					White - 00
Flush-mounted shower tray					
35 3/8"	35 3/8"	1 3/8"	35.5	720082 00 0 00 0090	755
39 3/8"	39 3/8"	1 3/8"	41.9	720085 00 0 00 0090	965
47 1/4"	47 1/4"	1 3/8"	61.0	720089 00 0 00 0090	1,115
Necessary accessories for shower tray					
Mounting set for # 720082 *				790140 00 0 00 0000	685
Mounting set for # 720085 *				790143 00 0 00 0000	735
Mounting set for # 720089 *				790147 00 0 00 0000	885
Accessories for shower tray					
Outlet drain, vertical outlet, (White -00, Chrome -10)				790262 00 0 00 * *00	140
Tile flange				790112 00 0 00 0000	225

Infobox: Observe preinstallation sheet / *Mounting set including support frame and border frame to limit the screed floor and the position of shower tray. Excluding the materials for sealing layer

DuraPlan Design by Prof. Frank Huster

Flush-mounted shower tray rectangle, cUPC listed
1/4" sanitary acrylic

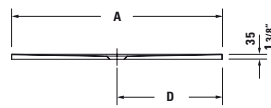
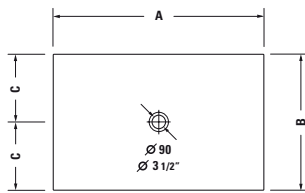



	A	B	C	D
720084	39 3/8"	35 3/8"	17 9/16"	19 9/16"
720084	993	893	446,5	496,5
720087	47 1/4"	35 3/8"	17 9/16"	23 1/2"
720087	1193	893	446,5	596,5
720088	47 1/4"	39 3/8"	19 9/16"	23 1/2"
720088	1193	993	496,5	596,5
720091	55 1/8"	35 3/8"	17 9/16"	27 7/16"
720091	1393	893	446,5	696,5
720092	63"	35 3/8"	17 9/16"	31 3/8"
720092	1593	893	446,5	796,5

Length inch	Width inch	Depth/Height inch	Weight lbs	Model-No.	USD
					White - 00
Flush-mounted shower tray					
39 3/8"	35 3/8"	1 3/8"	39.2	720084 00 0 00 0090	955
47 1/4"	35 3/8"	1 3/8"	49.2	720087 00 0 00 0090	1,100
47 1/4"	39 3/8"	1 3/8"	54.6	720088 00 0 00 0090	1,145
55 1/8"	35 3/8"	1 3/8"	57.5	720091 00 0 00 0090	1,240
63"	35 3/8"	1 3/8"	63.3	720092 00 0 00 0090	1,380
Necessary accessories for shower tray					
Mounting set for # 720084 *				790142 00 0 00 0000	705
Mounting set for # 720087 *				790145 00 0 00 0000	785
Mounting set for # 720088 *				790146 00 0 00 0000	805
Mounting set for # 720091 *				790149 00 0 00 0000	875
Mounting set for # 720092 *				790150 00 0 00 0000	930
Accessories for shower tray					
Outlet drain, vertical outlet, (White -00, Chrome -10)				790262 00 0 00 * *00	140
Tile flange				790112 00 0 00 0000	225

Infobox: Observe preinstallation sheet / *Mounting set including support frame and border frame to limit the screed floor and the position of shower tray. Excluding the materials for sealing layer

DuraPlan Accessories Design by Prof. Frank Huster

	Description	Model-No.	USD
	Mounting set *		
	for # 720082	790140 00 0 00 0000	685
	for # 720084	790142 00 0 00 0000	705
	for # 720085	790143 00 0 00 0000	735
	for # 720087	790145 00 0 00 0000	785
	for # 720088	790146 00 0 00 0000	805
	for # 720089	790147 00 0 00 0000	885
	for # 720091	790149 00 0 00 0000	875
	for # 720092	790150 00 0 00 0000	930
<div style="border: 1px solid black; padding: 5px;"> Infobox: *Mounting set including support frame and border frame to limit the screed floor and the position of shower tray. Excluding the materials for sealing layer </div>			
	Outlet drain		
	for DuraPlan shower trays, vertical outlet, 3 1/2" outlet, chrome trim		
	White	790262 00 0 00 0000	140
Chrome	790262 00 0 00 1000	140	