

*Contemporary Lines*  
***Exclusive***



Exclusive

EV 180



IT Miscelatore bicamando per vasca esterno con flessibile LONG LIFE e doccetta anticalcare  
 DE Zweigriff-Wannenbatterie Aufputz mit Brauseschlauch LONG LIFE und Handbrause mit Antikalk-System  
 FR Mélangeur bain douche avec flexible LONG LIFE et douchette anticalcaire orientable  
 EN External bath mixer with LONG LIFE flexible hose and anti-lime hand shower  
 ES Monobloc para bañera externo con flexible LONG LIFE y ducha anti-antical  
 RU Внешний смеситель для ванны со шлангом «LONG LIFE» и ручным душем с защитой от известковых отложений

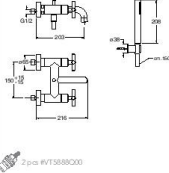

- S1 cromato 13 nero opaco 34 oro rosa 46 oro rosa lucido  
 24 bianco opaco 77 metallo spazzolato
- S2 oro giallo 72 cromo nero lucido 75 cromo nero spazzolato 92 ottone antico spazzolato  
 80 metallo lucido 77 metallo spazzolato

2 p.c.a. #V75880000

EV 181



IT Miscelatore bicamando per vasca esterno con flessibile LONG LIFE e doccetta anticalcare orientabile  
 DE Zweigriff-Wannenbatterie Aufputz mit Brauseschlauch LONG LIFE, Handbrause mit Antikalk-System und verstellbarem Wandhalter  
 FR Mélangeur bain douche avec flexible LONG LIFE et douchette anticalcaire orientable  
 EN External bath mixer with LONG LIFE flexible hose and adjustable anti-lime hand shower  
 ES Monobloc para bañera externo con flexible LONG LIFE y ducha orientable anti-antical  
 RU Внешний смеситель для ванны со шлангом «LONG LIFE» и регулируемым ручным душем с защитой от известковых отложений

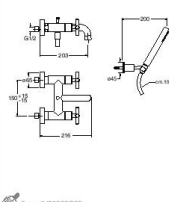

- S1 cromato 13 nero opaco 34 oro rosa 46 oro rosa lucido  
 24 bianco opaco 77 metallo spazzolato
- S2 oro giallo 72 cromo nero lucido 75 cromo nero spazzolato 92 ottone antico spazzolato  
 80 metallo lucido 77 metallo spazzolato

2 p.c.a. #V75880000

EV 187



IT Miscelatore bicamando per vasca esterno  
 DE Zweigriff-Wannenbatterie Aufputz  
 FR Mélangeur bain douche  
 EN External bath mixer  
 ES Monobloc para bañera externo  
 RU Внешний смеситель для ванны

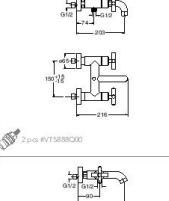

- S1 cromato 13 nero opaco 34 oro rosa 46 oro rosa lucido  
 24 bianco opaco 77 metallo spazzolato
- S2 oro giallo 72 cromo nero lucido 75 cromo nero spazzolato 92 ottone antico spazzolato  
 80 metallo lucido 77 metallo spazzolato

2 p.c.a. #V75880000

EV 157



IT Miscelatore termostatico per vasca esterno  
 DE Thermostat-Wannenbatterie Aufputz  
 FR Mlangeur thermostatique bain douche  
 EN External thermostatic bath mixer  
 ES Termostato para bañera externo  
 RU Внешний термостатический смеситель для ванны

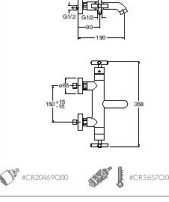

- S1 cromato 13 nero opaco 34 oro rosa 46 oro rosa lucido  
 24 bianco opaco 77 metallo spazzolato

2 p.c.a. #V75880000

Exclusive

EV 108



IT Miscelatore bicamando per vasca esterno con colonna a pavimento, flessibile LONG LIFE e doccetta anticalcare  
 DE Zweigriff-Wannenbatterie Aufputz bodentehend mit Brauseschlauch LONG LIFE und Handbrause mit Antikalk-System  
 FR Mélangeur bain douche extérieur sur pied avec flexible LONG LIFE et douchette anticalcaire  
 EN Floor mounted bath mixer with LONG LIFE flexible hose and anti-lime hand shower  
 ES Monobloc para bañera externo con columnas a pavimento, flexible LONG LIFE y ducha anti-antical  
 RU Настольный смеситель для ванны со шлангом «LONG LIFE» и ручным душем с защитой от известковых отложений

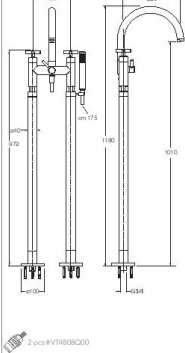

- S1 cromato 13 nero opaco 34 oro rosa 46 oro rosa lucido  
 24 bianco opaco 77 metallo spazzolato
- S2 oro giallo 72 cromo nero lucido 75 cromo nero spazzolato 92 ottone antico spazzolato  
 80 metallo lucido 77 metallo spazzolato

2 p.c.a. #V76800000

EV 114



IT Set completo per miscelatore bidomando doccia/vasca da incasso con deviatore 2 uscite  
 DE Unterputz 3 Loch Brause/Wannenbatterie inkl. Einbaukörper mit 2 Wege Umsteller  
 FR Mélangeur douche/bain douche encastré complet avec inverseur 2 sorties  
 EN Complete 3 hole concealed bath/shower mixer with 2 outlets diverter  
 ES Kit completo mezclador bimando baño/ducha de empotrar con desviador 2 salidas  
 RU Полный комплект скрытого смесителя для ванны/душа на 3 отверстия с переключателем с 2 выходами

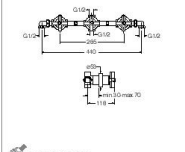

- S1 cromato 13 nero opaco 34 oro rosa 46 oro rosa lucido  
 24 bianco opaco 77 metallo spazzolato
- S2 oro giallo 72 cromo nero lucido 75 cromo nero spazzolato 92 ottone antico spazzolato  
 80 metallo lucido 77 metallo spazzolato

2 p.c.a. #V74720000

EV 115



IT Set completo per miscelatore bidomando doccia/vasca da incasso con deviatore 3 uscite  
 DE Unterputz 3 Loch Brause/Wannenbatterie inkl. Einbaukörper mit 3 Wege Umsteller  
 FR Mélangeur douche/bain douche encastré complet avec inverseur 3 sorties  
 EN Complete 3 hole concealed bath/shower mixer with 3 outlets diverter  
 ES Kit completo mezclador bimando baño/ducha de empotrar con desviador 3 salidas  
 RU Полный комплект скрытого смесителя для ванны/душа на 3 отверстия с переключателем с 3 выходами

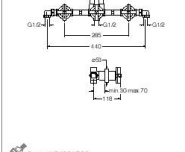

- S1 cromato 13 nero opaco 34 oro rosa 46 oro rosa lucido  
 24 bianco opaco 77 metallo spazzolato
- S2 oro giallo 72 cromo nero lucido 75 cromo nero spazzolato 92 ottone antico spazzolato  
 80 metallo lucido 77 metallo spazzolato

2 p.c.a. #V74720000

156 S1 cromato-chrome / 00 grigio-raw / 02 bianco-white / 03 luce blu-light blue / 06 luce bianca-light white / 13 nero opaco-black mat / 24 bianco opaco-white mat / 28 inox-stainless steel  
 34 oro rosa spazzolato-brushed rose gold / 46 oro rosa lucido-polished rose gold / 52 oro giallo-yellow gold / 53 ottone naturale-natural brass / 72 cromo nero lucido-polished black chrome  
 75 cromo nero spazzolato-brushed black chrome / 77 metallo spazzolato-brushed metal / 80 metallo lucido-polished metal / 86 sfumato-shaded / 92 ottone antico spazzolato-brushed old brass

157 S1 cromato-chrome / 00 grigio-raw / 02 bianco-white / 03 luce blu-light blue / 06 luce bianca-light white / 13 nero opaco-black mat / 24 bianco opaco-white mat / 28 inox-stainless steel  
 34 oro rosa spazzolato-brushed rose gold / 46 oro rosa lucido-polished rose gold / 52 oro giallo-yellow gold / 53 ottone naturale-natural brass / 72 cromo nero lucido-polished black chrome  
 75 cromo nero spazzolato-brushed black chrome / 77 metallo spazzolato-brushed metal / 80 metallo lucido-polished metal / 86 sfumato-shaded / 92 ottone antico spazzolato-brushed old brass

Exclusive

EV 111



IT Set completo per miscelatore bicomando vasca da incasso con bocca erogazione, flessibile LONG LIFE e doccetta anticalcare orientabile  
 DE Unterputz 3 Loch Warmwasserbatterie inkl. Einbraukörper mit Wannenreinlauf, Brauseschlauch LONG LIFE, Handbrause mit Antikalk-System und verstellbarem Wandhalter  
 FR Mélangeur douche/bain douche encastré complet avec bec de remplissage, flexible LONG LIFE et douchette anticalcaire orientable  
 EN Complete 3 hole concealed bath mixer with spout, LONG LIFE flexible hose and adjustable anti-lime hand shower  
 ES Kit completo mezclador bimando bañera de empotrar con caño llenado, flexible LONG LIFE, ducha antical orientable  
 RU Полный комплект скрытого смесителя для ванны на 3 отверстия с изливом, шлангом «LONG LIFE» и регулируемым ручным душем с системой против накипи

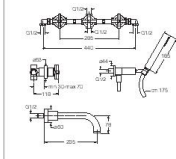

S1 cromato 13 nero opaco 34 oro rosa 46 oro rosa  
 24 bianco opaco spazzolato  
 S2 oro giallo 72 cromo nero lucido 75 cromo nero spazzolato 92 ottone antico  
 80 metallic lucido 77 metallic spazzolato

2 pici #V14724000

EV 113



IT Set completo per miscelatore bicomando vasca da incasso con bocca erogazione, soffione anticalcare ispezionabile, flessibile LONG LIFE e doccetta anticalcare  
 DE Unterputz 3 Loch Warmwasserbatterie inkl. Einbraukörper mit Wannenreinlauf, Kopfbrause mit Antikalk-System, Wischschlauch LONG LIFE und Handbrause mit Antikalk-System  
 FR Mélangeur douche/bain douche encastré complet avec bec de remplissage, pomme de douche anticalcaire démontable, flexible LONG LIFE et douchette anticalcaire  
 EN Complete 3 hole concealed bath mixer with spout, checkable anti-lime overhead shower, LONG LIFE flexible hose and anti-lime hand shower  
 ES Kit completo mezclador bimando bañera de empotrar con caño llenado, rociador antical ispezionable, flexible LONG LIFE y ducha antical  
 RU Полный комплект скрытого смесителя для ванны на 3 отверстия с изливом, регулируемым верхним душем с защитой от известковых отложений, шлангом «LONG LIFE» и ручным душем с защитой от накипи

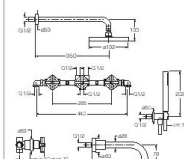

S1 cromato 13 nero opaco 34 oro rosa 46 oro rosa  
 24 bianco opaco spazzolato  
 S2 oro giallo 72 cromo nero lucido 75 cromo nero spazzolato 92 ottone antico  
 80 metallic lucido 77 metallic spazzolato

2 pici #V1474000

XV 142



IT Miscelatore termostatico per bordo vasca con deviatore 2 uscite  
 DE Thermostat Warmwasserbatterie mit 2 Wege Umsteller  
 FR Mlgeur thermostatique bain douche sur gorge avec inverseur 2 sorties  
 EN Deck mounted thermostatic bath mixer with 2 outlets diverter  
 ES Termostato para grupo bañera con desviador 2 salidas  
 RU Термостатический смеситель для ванны для монтажа на бортик с переключателем с 2 выходами

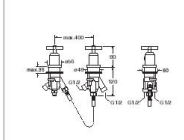

S1 cromato 13 nero opaco 34 oro rosa 46 oro rosa  
 24 bianco opaco spazzolato  
 S2 oro giallo 72 cromo nero lucido 75 cromo nero spazzolato 92 ottone antico  
 80 metallic lucido 77 metallic spazzolato

2 pici #CR1544000

158 S1 cromo-chrome / 00 grigio-raw / 02 bianco-white / 03 luce blu-light blue / 06 luce bianca-light white / 13 nero opaco-black mat / 24 bianco opaco-white mat / 28 inox-stainless steel  
 34 oro rosa spazzolato-brushed rose gold / 46 oro rosa lucido-polished rose gold / 52 oro giallo-yellow gold / 53 ottone naturale-natural brass / 72 cromo nero lucido-polished black chrome  
 75 cromo nero spazzolato-brushed black chrome / 77 metallic spazzolato-brushed metallic / 80 metallic lucido-polished metallic / 86 sfumato-shaded / 92 ottone antico spazzolato-brushed old brass

Exclusive

XV 143



IT Miscelatore termostatico per bordo vasca con deviatore 3 uscite  
 DE Thermostat Warmwasserbatterie mit 3 Wege Umsteller  
 FR Mlgeur thermostatique bain douche sur gorge avec inverseur 3 sorties  
 EN Deck mounted thermostatic bath mixer with 3 outlets diverter  
 ES Termostato para grupo bañera con desviador 3 salidas  
 RU Термостатический смеситель для ванны для монтажа на бортик с переключателем с 3 выходами

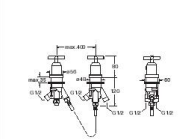

S1 cromato 13 nero opaco 34 oro rosa 46 oro rosa  
 24 bianco opaco spazzolato  
 S2 oro giallo 72 cromo nero lucido 75 cromo nero spazzolato 92 ottone antico  
 80 metallic lucido 77 metallic spazzolato

2 pici #CR15441000

EV 124 LARGE



IT Miscelatore bicomando LARGE per bordo vasca 4 fori con bocca erogazione, doccetta anticalcare estraibile e deviatore  
 DE 4 Loch Warmwassercombination LARGE mit Umsteller, Wannenreinlauf und herausziehbarer Handbrause mit Antikalk-System  
 FR Mélangeur bain douche LARGE sur gorge 4 trous avec inverseur, bec de remplissage et douchette anticalcaire extractible  
 EN 4 hole deck mounted bath mixer LARGE with diverter, spout and pull-out anti-lime hand shower  
 ES Monobloc LARGE para grupo bañera 4 agujeros con caño de llenado, ducha antical extractible y desviador  
 RU Смеситель для ванны для монтажа на бортик на 4 отверстия с переключателем, изливом и съёмным ручным душем LARGE с защитой от известковых отложений

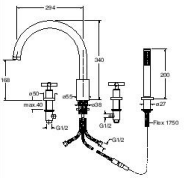

S1 cromato 13 nero opaco 34 oro rosa 46 oro rosa  
 24 bianco opaco spazzolato  
 S2 oro giallo 72 cromo nero lucido 75 cromo nero spazzolato 92 ottone antico  
 80 metallic lucido 77 metallic spazzolato

2 pici #V1588000

EV 126 REGULAR



IT Miscelatore bicomando REGULAR per bordo vasca 4 fori con bocca erogazione, doccetta anticalcare estraibile e deviatore  
 DE 4 Loch Warmwassercombination REGULAR mit Umsteller, Wannenreinlauf und herausziehbarer Handbrause mit Antikalk-System  
 FR Mélangeur bain douche REGULAR sur gorge 4 trous avec inverseur, bec de remplissage et douchette anticalcaire extractible  
 EN 4 hole deck mounted bath mixer REGULAR with diverter, spout and pull-out anti-lime hand shower  
 ES Monobloc REGULAR para grupo bañera 4 agujeros con caño de llenado, ducha antical extractible y desviador  
 RU Смеситель для ванны для монтажа на бортик на 4 отверстия с переключателем, изливом и съёмным ручным душем REGULAR с защитой от известковых отложений

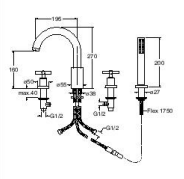

S1 cromato 13 nero opaco 34 oro rosa 46 oro rosa  
 24 bianco opaco spazzolato  
 S2 oro giallo 72 cromo nero lucido 75 cromo nero spazzolato 92 ottone antico  
 80 metallic lucido 77 metallic spazzolato

2 pici #V1588000

159 S1 cromo-chrome / 00 grigio-raw / 02 bianco-white / 03 luce blu-light blue / 06 luce bianca-light white / 13 nero opaco-black mat / 24 bianco opaco-white mat / 28 inox-stainless steel  
 34 oro rosa spazzolato-brushed rose gold / 46 oro rosa lucido-polished rose gold / 52 oro giallo-yellow gold / 53 ottone naturale-natural brass / 72 cromo nero lucido-polished black chrome  
 75 cromo nero spazzolato-brushed black chrome / 77 metallic spazzolato-brushed metallic / 80 metallic lucido-polished metallic / 86 sfumato-shaded / 92 ottone antico spazzolato-brushed old brass

Exclusive

EV 122



IT Miscelatore bicomando per bordo vasca 4 fori con sboccata anticalcare estraibile, deviatore 2 uscite e FOLLOW ME.  
 DE 4 Loch Wannrandkombination mit herausziehbarer Handbrause mit Antikalk-System, 2 Wege Umsteller und FOLLOW ME - Funktion.  
 FR Mélangeur bain douche sur gorge 4 trous avec douche amovible extractible, inverseur 2 sorties et FOLLOW ME.  
 EN 4 hole deck mounted bath mixer with pull-out anti-lime hand shower, 2 outlets diverter and FOLLOW ME.  
 ES Monobloc bidé para grupo bañera 4 agujeros con ducha extraíble anticaída, desviador 2 salidas y FOLLOW ME.  
 RU Смеситель для ванны для монтажа на бортике на 4 отверстия со съемным ручным душем и переключателем с двумя выходами и FOLLOW ME.

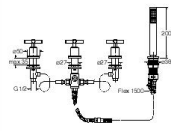

51 cromo 12 nero opaco / 24 bianco opaco / 34 oro rosa spazzolato / 46 oro rosa lucido  
 52 oro giallo / 72 cromo nero lucido / 75 cromo nero spazzolato / 92 ottone antico spazzolato

2 pezzi #V756/80C00

EV 131



IT Miscelatore bicomando per bordo vasca con deviatore 2 uscite e piastra in metallo.  
 DE Zweigriff-Wannenrandbatterie mit 2 Wege Umsteller und Abdeckplatte aus Metall.  
 FR Mélangeur bain douche sur gorge avec inverseur 2 sorties et plaque EN métal.  
 EN Deck mounted bath mixer with 2 outlet diverter and metal plate.  
 ES Monobloc para grupo bañera con desviador 2 salidas y placa de metal.  
 RU Смеситель для ванны для монтажа на бортик с переключателем с 2 выходами.

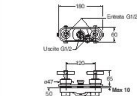

51 cromo

2 pezzi #V756/80C00

EV 220 REGULAR



IT Miscelatore monocomando progressivo REGULAR per lavabo con scarico Up&Down da 1"1/4.  
 DE Waschtisch-Einhandmischer REGULAR mit progressiver Kartusche und Ablaufgarnitur Up&Down 1"1/4.  
 FR Mijeuir lavabo REGULAR cartouche progressive avec vidage Up&Down 1"1/4.  
 EN Progressive basin mixer REGULAR with 1"1/4 Up&Down waste.  
 ES Monobloc REGULAR para lavabo 3 agujeros con desagüe Up&Down de 1"1/4.  
 RU Прогрессивный смеситель для раковины REGULAR с нажимным донным клапаном 1"1/4.

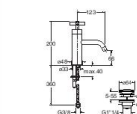

51 cromo

2 pezzi #CR220/A00

51 cromo-chrome / 00 grigio-raw / 02 bianco-white / 03 luce blu-light blue / 06 luce bianca-light white / 13 nero opaco-black mat / 24 bianco opaco-white mat / 28 inox-stainless steel / 34 oro rosa spazzolato-brushed rose gold / 46 oro rosa lucido-polished rose gold / 52 oro giallo-yellow gold / 53 ottone naturale-natural brass / 72 cromo nero lucido-polished black chrome / 75 cromo nero spazzolato-brushed black chrome / 77 metallo spazzolato-brushed metal / 80 metallo lucido-polished metal / 86 sfumato-shaded / 92 ottone antico spazzolato-brushed old brass

Exclusive

EV 920 REGULAR



IT Miscelatore monocomando progressivo REGULAR per lavabo senza scarico.  
 DE Waschtisch-Einhandmischer REGULAR mit progressiver Kartusche ohne Ablaufgarnitur.  
 FR Mijeuir lavabo REGULAR cartouche progressive sans vidage.  
 EN Progressive basin mixer REGULAR without pop up.  
 ES Monobloc REGULAR para lavabo 3 agujeros sin desagüe.  
 RU Прогрессивный смеситель для раковины REGULAR без донного клапана.

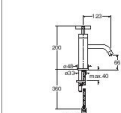

51 cromo

2 pezzi #CR220/A00

EV 221 REGULAR



IT Miscelatore monocomando progressivo REGULAR per lavabo con scarico da 1"1/4 e asta comando.  
 DE Waschtisch-Einhandmischer REGULAR mit progressiver Kartusche und Ablaufgarnitur 1"1/4 und Zugstange.  
 FR Mijeuir lavabo REGULAR cartouche progressive avec vidage 1"1/4 et tette.  
 EN Progressive basin mixer REGULAR with 1"1/4 pop up waste.  
 ES Monocomando progressivo REGULAR para bidé con desagüe automático de 1"1/4.  
 RU Прогрессивный смеситель для раковины REGULAR с нажимным донным клапаном 1"1/4.

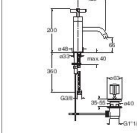

51 cromo

2 pezzi #CR220/A00

EV 225 MEDIUM



IT Miscelatore monocomando progressivo MEDIUM per lavabo con scarico Up&Down da 1"1/4.  
 DE Waschtisch-Einhandmischer MEDIUM mit progressiver Kartusche und Ablaufgarnitur Up&Down 1"1/4.  
 FR Mijeuir lavabo cartouche progressive MEDIUM avec vidage Up&Down 1"1/4.  
 EN Progressive basin mixer MEDIUM with 1"1/4 Up&Down waste.  
 ES Monocomando progressivo MEDIUM para lavabo con desagüe Up&Down de 1"1/4.  
 RU Прогрессивный смеситель для раковины MEDIUM с нажимным донным клапаном 1"1/4.

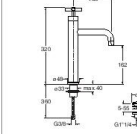

51 cromo

2 pezzi #CR220/A00

51 cromo-chrome / 00 grigio-raw / 02 bianco-white / 03 luce blu-light blue / 06 luce bianca-light white / 13 nero opaco-black mat / 24 bianco opaco-white mat / 28 inox-stainless steel / 34 oro rosa spazzolato-brushed rose gold / 46 oro rosa lucido-polished rose gold / 52 oro giallo-yellow gold / 53 ottone naturale-natural brass / 72 cromo nero lucido-polished black chrome / 75 cromo nero spazzolato-brushed black chrome / 77 metallo spazzolato-brushed metal / 80 metallo lucido-polished metal / 86 sfumato-shaded / 92 ottone antico spazzolato-brushed old brass

Exclusive

EV 925 MEDIUM



IT Miscelatore monocomando progressivo MEDIUM per lavabo senza scarico  
 DE Waschtisch-Einhandmischer MEDIUM mit progressiver Kartusche ohne Ablaufgarnitur  
 FR Migeur lavabo cartouche progressive MEDIUM sans vidage  
 EN Progressive basin mixer MEDIUM without pop up  
 ES Monomando progresivo MEDIUM para lavabo sin desagüe  
 RU Прогрессивный смеситель для раковины MEDIUM без донного клапана

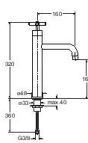

51 cromato



EV 922 TALL



IT Miscelatore monocomando progressivo TALL per lavabo con scarico Up&Down da 1"1/4  
 DE Waschtisch-Einhandmischer TALL mit progressiver Kartusche und Ablaufgarnitur Up&Down 1"1/4  
 FR Migeur lavabo cartouche progressive TALL avec vidage Up&Down 1"1/4  
 EN Progressive basin mixer TALL with 1"1/4 Up&Down waste  
 ES Monomando progresivo TALL para lavabo con desagüe Up&Down de 1"1/4  
 RU Прогрессивный смеситель для раковины TALL с нажимным донным клапаном 1"1/4

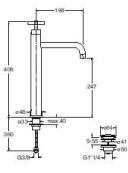

51 cromato



EV 922 TALL



IT Miscelatore monocomando progressivo TALL per lavabo senza scarico  
 DE Waschtisch-Einhandmischer TALL mit progressiver Kartusche ohne Ablaufgarnitur  
 FR Migeur lavabo cartouche progressive TALL sans vidage  
 EN Progressive basin mixer TALL without pop up  
 ES Monomando progresivo TALL para lavabo sin desagüe  
 RU Прогрессивный смеситель для раковины TALL без донного клапана

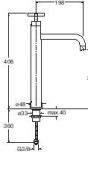

51 cromato



51 cromato-chrome / 00 grigio-raw / 02 bianco-white / 03 luce blu-light blue / 06 luce bianca-light white / 13 nero opaco-black mat / 24 bianco opaco-white mat / 28 inox-stainless steel  
 34 oro rosa-brushed rose gold / 44 oro rosa lucido-polished rose gold / 52 oro giallo-yellow gold / 53 ottone naturale-natural brass / 72 ottone nero lucido-polished black chrome  
 75 ottone nero spazzolato-brushed black chrome / 77 metallo spazzolato-brushed metal / 80 metallo lucido-polished metal / 86 sfumato-shaded / 92 ottone antico spazzolato-brushed old brass

Exclusive

EV 205 REGULAR



IT Miscelatore bicomando REGULAR per lavabo 3 fori con scarico da 1"1/4 e asta comando  
 DE 3-Loch-Waschtischbatterie REGULAR mit Ablaufgarnitur 1"1/4 und Zugstange  
 FR Mélangeur lavabo 3 trous REGULAR avec vidage 1"1/4 à trette  
 EN 3 hole basin mixer REGULAR with 1"1/4 pop up waste  
 ES Monobloc REGULAR para lavabo 3 agujeros con desagüe automático de 1"1/4  
 RU Смеситель для раковины на 3 отверстия REGULAR с нажимным донным клапаном 1"1/4

51 cromato 13 nero opaco 24 bianco opaco 28 metallo opaco 34 oro rosa spazzolato 44 oro rosa lucido 52 oro giallo 72 ottone nero lucido 75 ottone nero spazzolato 92 ottone antico 80 metallo lucido 77 metallo spazzolato spazzolato

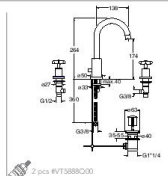

EV 226 REGULAR



IT Miscelatore bicomando REGULAR per lavabo con scarico da 1"1/4 e asta comando  
 DE Zweigriff-Waschtischbatterie REGULAR mit Ablaufgarnitur 1"1/4 und Zugstange  
 FR Mélangeur lavabo REGULAR avec vidage 1"1/4 à trette  
 EN Basin mixer REGULAR with 1"1/4 pop up waste  
 ES Monobloc REGULAR para lavabo con desagüe automático de 1"1/4  
 RU Смеситель для раковины REGULAR с нажимным донным клапаном 1"1/4

51 cromato 13 nero opaco 24 bianco opaco 34 oro rosa spazzolato 44 oro rosa lucido 52 oro giallo 72 ottone nero lucido 75 ottone nero spazzolato 92 ottone antico 80 metallo lucido 77 metallo spazzolato spazzolato

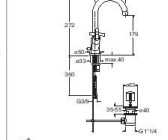

EV 248 TALL



IT Miscelatore bicomando TALL per lavabo con scarico Up&Down da 1"1/4  
 DE Zweigriff-Waschtischbatterie TALL mit Ablaufgarnitur Up&Down 1"1/4  
 FR Mélangeur lavabo TALL avec vidage Up&Down 1"1/4  
 EN Basin mixer TALL with 1"1/4 Up&Down waste  
 ES Monobloc TALL para lavabo con desagüe Up&Down de 1"1/4  
 RU Смеситель для раковины TALL с донным клапаном Up&Down 1"1/4

51 cromato 13 nero opaco 24 bianco opaco 34 oro rosa spazzolato 44 oro rosa lucido 52 oro giallo 72 ottone nero lucido 75 ottone nero spazzolato 92 ottone antico 80 metallo lucido 77 metallo spazzolato spazzolato

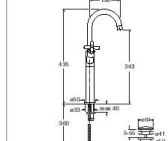

EV 948 TALL







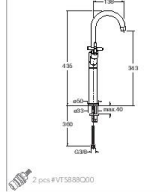

IT Miscelatore bicomando TALL per lavabo senza scarico  
 DE Zweigriff-Waschtischbatterie TALL ohne Ablaufgarnitur  
 FR Mélangeur lavabo TALL sans vidage  
 EN Basin mixer TALL without pop up  
 ES Monobloc TALL para lavabo sin desagüe  
 RU Смеситель для раковины TALL без донного клапана

51 cromato

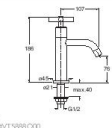

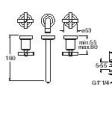

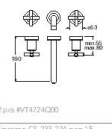

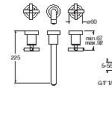

51 cromato-chrome / 00 grigio-raw / 02 bianco-white / 03 luce blu-light blue / 06 luce bianca-light white / 13 nero opaco-black mat / 24 bianco opaco-white mat / 28 inox-stainless steel  
 34 oro rosa spazzolato-brushed rose gold / 44 oro rosa lucido-polished rose gold / 52 oro giallo-yellow gold / 53 ottone naturale-natural brass / 72 ottone nero lucido-polished black chrome  
 75 ottone nero spazzolato-brushed black chrome / 77 metallo spazzolato-brushed metal / 80 metallo lucido-polished metal / 86 sfumato-shaded / 92 ottone antico spazzolato-brushed old brass

Exclusive

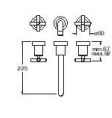
<p><b>EV 230</b></p> 	<p>IT Rubinetto "acqua fredda" da 1/2" DE Standventil 1/2" mit Kaltwasseranschluss FR Robinet "eau froide" 1/2" EN 1/2" "cold water" tap ES Grifo "agua fría" de 1/2" RU Кран холодной воды 1/2"</p> <p>S1 cromato 13 nero opaco 34 oro rosa 46 oro rosa 24 bianco opaco 34 spazzolato 46 ottone lucido</p> <p>S2 oro giallo 72 ottone nero lucido 75 ottone nero spazzolato 92 ottone antico 80 metallic lucido 77 metallic spazzolato</p> <p>2 pcs #V7588000</p> 
<p><b>EV 242</b> REGULAR</p> 	<p>IT Set da esterno miscelatore bicomando lavabo REGULAR per CS 233 (comandi laterali) - CS 234 (comando destro) con scarico Up&amp;Down da 1"1/4 DE Fertigmontage-set Zweigriff-Waschtischbatterie REGULAR Wandmontage für Einbaukörper CS 233 (seitliche Griffe) - CS 234 (Griffe rechts) mit Ablaufgarnitur Up&amp;Down 1"1/4 FR Façade externe mélangeur lavabo encastré REGULAR pour CS 233 (commandes latérales) - CS 234 (distrib) avec vidage Up&amp;Down 1"1/4 EN Wall mounted basin mixer REGULAR external parts for CS 233 (side controls) - CS 234 (right side) with 1"1/4 Up&amp;Down waste ES Kit exterior mezclador bimando REGULAR lavabo CS 233 (controles laterales) - CS 234 (diestro) sin desague Up&amp;Down de 1"1/4 RU Наружные части настенного смесителя для раковины REGULAR для CS 233 (боксовые ручки) - CS 234 (правосторонний) с донным клапаном Up&amp;Down 1"1/4</p> <p>S1 cromato 13 nero opaco 34 oro rosa 46 oro rosa 24 bianco opaco 34 spazzolato 46 ottone lucido</p> <p>S2 oro giallo 72 ottone nero lucido 75 ottone nero spazzolato 92 ottone antico 80 metallic lucido 77 metallic spazzolato</p> <p>2 pcs #V7472000</p>  <p>Set da incasso CS 233-234 pag. 15 Unterputz-Einbaukörper CS 233-234 Seite 15 Mixer-ensemble encastré CS 233-234 page 15 Compléted body CS 233-234 page 15 Сборка для монтажа CS 233-234 pagina 15 Встраиваемый комплект CS 233-234 стр. 15</p>
<p><b>EV 942</b> REGULAR</p> 	<p>IT Set da esterno miscelatore bicomando lavabo REGULAR per CS 233 (comandi laterali) - CS 234 (comando destro) senza scarico DE Fertigmontage-set Zweigriff-Waschtischbatterie REGULAR Wandmontage für Einbaukörper CS 233 (seitliche Griffe) - CS 234 (Griffe rechts) ohne Ablaufgarnitur FR Façade externe mélangeur lavabo encastré REGULAR pour CS 233 (commandes latérales) - CS 234 (distrib) sans vidage EN Wall mounted basin mixer REGULAR external parts for CS 233 (side controls) - CS 234 (right side) without pop up ES Kit exterior mezclador bimando REGULAR lavabo CS 233 (controles laterales) - CS 234 (diestro) sin desague RU Наружные части настенного смесителя для раковины REGULAR для CS 233 (боксовые ручки) - CS 234 (правосторонний) без донного клапана</p> <p>S1 cromato</p> <p>2 pcs #V7472000</p>  <p>Set da incasso CS 233-234 pag. 15 Unterputz-Einbaukörper CS 233-234 Seite 15 Mixer-ensemble encastré CS 233-234 page 15 Compléted body CS 233-234 page 15 Сборка для монтажа CS 233-234 pagina 15 Встраиваемый комплект CS 233-234 стр. 15</p>
<p><b>EV 241</b> LARGE</p> 	<p>IT Set da esterno miscelatore bicomando lavabo LARGE per CS 233 (comandi laterali) - CS 234 (comando destro) con scarico Up&amp;Down da 1"1/4 DE Fertigmontage-set Zweigriff-Waschtischbatterie LARGE Wandmontage für Einbaukörper CS 233 (seitliche Griffe) - CS 234 (Griffe rechts) mit Ablaufgarnitur Up&amp;Down 1"1/4 FR Façade externe mélangeur lavabo encastré LARGE pour CS 233 (commandes latérales) - CS 234 (distrib) avec vidage Up&amp;Down 1"1/4 EN Wall mounted basin mixer LARGE external parts for CS 233 (side controls) - CS 234 (right side) with 1"1/4 Up&amp;Down waste ES Kit exterior mezclador bimando LARGE lavabo CS 233 (controles laterales) - CS 234 (diestro) con desague Up&amp;Down de 1"1/4 RU Наружные части настенного смесителя для раковины LARGE для CS 233 (боксовые ручки) - CS 234 (правосторонний) с донным клапаном Up&amp;Down 1"1/4</p> <p>S1 cromato 34 oro rosa 46 oro rosa 52 oro giallo 72 ottone nero lucido 75 ottone nero spazzolato</p> <p>2 pcs #V7472000</p>  <p>Set da incasso CS 233-234 pag. 15 Unterputz-Einbaukörper CS 233-234 Seite 15 Mixer-ensemble encastré CS 233-234 page 15 Compléted body CS 233-234 page 15 Сборка для монтажа CS 233-234 pagina 15 Встраиваемый комплект CS 233-234 стр. 15</p>

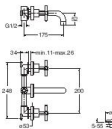
31 cromato-chrome / 00 grigio-raw / 02 bianco-white / 03 luce blu-light blue / 09 luce bianca-light white / 13 nero opaco-black mat / 24 bianco opaco-white mat / 28 inox-stainless steel / 34 oro rosa spazzolato-brushed rose gold / 46 oro rosa lucido-polished rose gold / 52 oro giallo-yellow gold / 53 ottone naturale-natural brass / 72 ottone nero lucido-polished black chrome / 75 ottone nero spazzolato-brushed black chrome / 77 metallic spazzolato-brushed metallic / 80 metallic lucido-polished metallic / 86 sfumato-shaded / 92 ottone antico spazzolato-brushed old brass

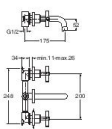
Exclusive

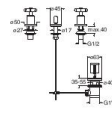
<p><b>EV 941</b> LARGE</p> 	<p>IT Set da esterno miscelatore bicomando lavabo LARGE per CS 233 (comandi laterali) - CS 234 (comando destro) senza scarico DE Fertigmontage-set Zweigriff-Waschtischbatterie LARGE Wandmontage für Einbaukörper CS 233 (seitliche Griffe) - CS 234 (Griffe rechts) ohne Ablaufgarnitur FR Façade externe mélangeur lavabo encastré LARGE pour CS 233 (commandes latérales) - CS 234 (distrib) sans vidage EN Wall mounted basin mixer LARGE external parts for CS 233 (side controls) - CS 234 (right side) without pop up ES Kit exterior mezclador bimando LARGE lavabo CS 233 (controles laterales) - CS 234 (diestro) sin desague RU Наружные части настенного смесителя для раковины LARGE для CS 233 (боксовые ручки) - CS 234 (правосторонний) без донного клапана</p> <p>S1 cromato</p> <p>2 pcs #V7472000</p>  <p>Set da incasso CS 233-234 pag. 15 Unterputz-Einbaukörper CS 233-234 Seite 15 Mixer-ensemble encastré CS 233-234 page 15 Compléted body CS 233-234 page 15 Сборка для монтажа CS 233-234 pagina 15 Встраиваемый комплект CS 233-234 стр. 15</p>
<p><b>EV 233</b></p> 	<p>IT Set completo per miscelatore bicomando lavabo da incasso per pannello con scarico Up&amp;Down da 1"1/4 DE Unterputz Zweigriff-Waschtischbatterie Wandmontage inkl. Einbaukörper für Panel mit Ablaufgarnitur Up&amp;Down 1"1/4 FR Mélangeur lavabo encastré complet pour panneau avec vidage Up&amp;Down 1"1/4 EN Complete panel mounted basin mixer with 1"1/4 Up&amp;Down waste ES Kit completo mezclador bimando lavabo de empotrar para panel con desague Up&amp;Down de 1"1/4 RU Полный комплект смесителя для раковины для монтажа на бортик с донным клапаном Up&amp;Down 1"1/4</p> <p>S1 cromato 13 nero opaco 34 oro rosa 46 oro rosa 24 bianco opaco 34 spazzolato 46 ottone lucido</p> <p>S2 oro giallo 72 ottone nero lucido 75 ottone nero spazzolato 92 ottone antico 80 metallic lucido 77 metallic spazzolato</p> <p>2 pcs #V7472000</p>  <p>Set da incasso CS 233-234 pag. 15 Unterputz-Einbaukörper CS 233-234 Seite 15 Mixer-ensemble encastré CS 233-234 page 15 Compléted body CS 233-234 page 15 Сборка для монтажа CS 233-234 pagina 15 Встраиваемый комплект CS 233-234 стр. 15</p>
<p><b>EV 933</b></p> 	<p>IT Set completo per miscelatore bicomando lavabo da incasso per pannello senza scarico DE Unterputz Zweigriff-Waschtischbatterie Wandmontage inkl. Einbaukörper für Panel ohne Ablaufgarnitur FR Mélangeur lavabo encastré complet pour panneau sans vidage Up&amp;Down 1"1/4 EN Complete panel mounted basin mixer without pop up ES Kit completo mezclador bimando lavabo de empotrar para panel sin desague RU Полный комплект смесителя для раковины для монтажа на бортик без донного клапана</p> <p>S1 cromato</p> <p>2 pcs #V7472000</p>  <p>Set da incasso CS 233-234 pag. 15 Unterputz-Einbaukörper CS 233-234 Seite 15 Mixer-ensemble encastré CS 233-234 page 15 Compléted body CS 233-234 page 15 Сборка для монтажа CS 233-234 pagina 15 Встраиваемый комплект CS 233-234 стр. 15</p>
<p><b>EV 300</b></p> 	<p>IT Miscelatore bicomando per bidet 3 fori con scarico da 1"1/4 e asta comando DE 3 Loch-Bidetbatterie mit Ablaufgarnitur 1"1/4 und Zerstänge FR Mélangeur bidet 3 trous avec vidage 1"1/4 à trette EN 3 hole bidet mixer with 1"1/4 pop up waste ES Monobloc bidé 3 agujeros con desague automático de 1"1/4 RU Смеситель для биде на 3 отверстия с нажимным донным клапаном 1"1/4</p> <p>S1 cromato 13 nero opaco 34 oro rosa 46 oro rosa 24 bianco opaco 34 spazzolato 46 ottone lucido</p> <p>S2 oro giallo 72 ottone nero lucido 75 ottone nero spazzolato 92 ottone antico 80 metallic lucido 77 metallic spazzolato</p> <p>2 pcs #V7588000</p> 

31 cromato-chrome / 00 grigio-raw / 02 bianco-white / 03 luce blu-light blue / 09 luce bianca-light white / 13 nero opaco-black mat / 24 bianco opaco-white mat / 28 inox-stainless steel / 34 oro rosa spazzolato-brushed rose gold / 46 oro rosa lucido-polished rose gold / 52 oro giallo-yellow gold / 53 ottone naturale-natural brass / 72 ottone nero lucido-polished black chrome / 75 ottone nero spazzolato-brushed black chrome / 77 metallic spazzolato-brushed metallic / 80 metallic lucido-polished metallic / 86 sfumato-shaded / 92 ottone antico spazzolato-brushed old brass

Exclusive



**EV 320**

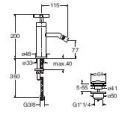

IT Miscelatore monocomando progressivo per bidet con scarico Up&Down da 1"1/4  
 DE Bidet-Einhandmischer mit progressiver Kartusche und Ablaufgarnitur Up&Down 1"1/4  
 FR Migeur bidet cartouche progressive avec vidage Up&Down 1"1/4  
 EN Progressive bidet mixer with 1"1/4 Up&Down waste  
 ES Monomando progresivo para bidé con desagüe Up&Down de 1"1/4  
 RU Прогрессивный смеситель для биде с нажимным донным клапаном 1"1/4



51 cromato



**EV 370**



IT Miscelatore monocomando progressivo per bidet senza scarico  
 DE Bidet-Einhandmischer mit progressiver Kartusche ohne Ablaufgarnitur  
 FR Migeur bidet cartouche progressive sans vidage  
 EN Progressive bidet mixer without pop up  
 ES Monomando progresivo para bidé sin desagüe  
 RU Прогрессивный смеситель для биде без донного клапана

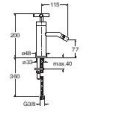

51 cromato



**EV 321**



IT Miscelatore monocomando progressivo per bidet con scarico da 1"1/4 e asta comando  
 DE Bidet-Einhandmischer mit progressiver Kartusche und Ablaufgarnitur 1"1/4 und Zugstange  
 FR Migeur bidet cartouche progressive avec vidage 1"1/4 à trette  
 EN Progressive bidet mixer with 1"1/4 pop up waste  
 ES Monomando progresivo para bidé con desagüe automático de 1"1/4  
 RU Прогрессивный смеситель для биде с нажимным донным клапаном 1"1/4

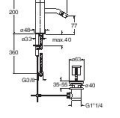

51 cromato



**EV 326**



IT Miscelatore bicomando per bidet con scarico da 1"1/4 e asta comando  
 DE Zweigriff-Bidetbatterie mit Ablaufgarnitur 1"1/4 und Zugstange  
 FR Mélangeur bidet avec vidage 1"1/4 à trette  
 EN Bidet mixer with 1"1/4 pop up waste  
 ES Monobloc bidé con desagüe automático de 1"1/4  
 RU Смеситель для биде с нажимным донным клапаном 1"1/4

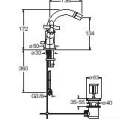

51 cromato 13 nero opaco 34 oro rosa 46 oro rosa  
 24 bianco opaco spazzolato lucido  
 52 oro giallo 72 ottone nero lucido 75 ottone nero spazzolato 92 ottone antico  
 80 metallic lucido 77 metallic spazzolato spazzolato





Exclusive



**EV 330**

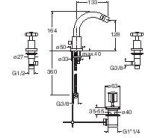

IT Miscelatore bicomando per bidet 3 fori con scarico da 1"1/4 e asta comando  
 DE 3-Loch Bidetbatterie mit Ablaufgarnitur 1"1/4 und Zugstange  
 FR Mélangeur bidet 3 trous avec vidage 1"1/4 à trette  
 EN 3 hole bidet mixer with 1"1/4 pop up waste  
 ES Monobloc bidé 3 agujeros con desagüe automático de 1"1/4  
 RU Смеситель для биде на 3 отверстия с нажимным донным клапаном 1"1/4



51 cromato 13 nero opaco 34 oro rosa 46 oro rosa  
 24 bianco opaco spazzolato lucido  
 52 oro giallo 72 ottone nero lucido 75 ottone nero spazzolato 92 ottone antico  
 80 metallic lucido 77 metallic spazzolato spazzolato



**EV 481**



IT Miscelatore bicomando per doccia esterno  
 DE Zweigriff-Brausebatterie Außenputz  
 FR Mélangeur douche extérieur  
 EN External shower mixer  
 ES Monobloc para ducha externa  
 RU Внешний смеситель для душа

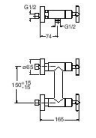

51 cromato 13 nero opaco 34 oro rosa 46 oro rosa  
 24 bianco opaco spazzolato lucido  
 52 oro giallo 72 ottone nero lucido 75 ottone nero spazzolato 92 ottone antico  
 80 metallic lucido 77 metallic spazzolato spazzolato



**EV 451**



IT Miscelatore termostatico per doccia esterno  
 DE Thermostat-Brausebatterie Außenputz  
 FR Migeur douche thermostatique extérieur  
 EN External thermostatic shower mixer  
 ES Termostato para ducha externo  
 RU Внешний термостатический смеситель для душа

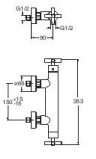

51 cromato 13 nero opaco 24 bianco opaco

166  51 cromato-chrome / 00 grigio-raw / 02 bianco-white / 03 luce blu-light blue / 06 luce bianca-light white / 13 nero opaco-black mat / 24 bianco opaco-white mat / 28 inox-stainless steel / 34 oro rosa-brushed rose gold / 46 oro rosa lucido-polished rose gold / 52 oro giallo-yellow gold / 53 ottone naturale-natural brass / 72 ottone nero lucido-polished black chrome / 75 ottone nero spazzolato-brushed black chrome / 77 metallic spazzolato-brushed metallic / 80 metallic lucido-polished metallic / 86 sfumato-shaded / 92 ottone antico spazzolato-brushed old brass

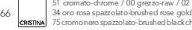
51 cromato-chrome / 00 grigio-raw / 02 bianco-white / 03 luce blu-light blue / 06 luce bianca-light white / 13 nero opaco-black mat / 24 bianco opaco-white mat / 28 inox-stainless steel / 34 oro rosa spazzolato-brushed rose gold / 46 oro rosa lucido-polished rose gold / 52 oro giallo-yellow gold / 53 ottone naturale-natural brass / 72 ottone nero lucido-polished black chrome / 75 ottone nero spazzolato-brushed black chrome / 77 metallic spazzolato-brushed metallic / 80 metallic lucido-polished metallic / 86 sfumato-shaded / 92 ottone antico spazzolato-brushed old brass 

**Exclusive**

**EV 409**



IT Miscelatore bicomando per doccia esterno con colonne a pavimento, soffione anticalcare ispezionabile, flessibile LONG LIFE e doccetta anticalcare  
 DE Zweigriff-Brausebatterie Aufputz bodenstehend mit Kopfbrause mit Antikalk-System, Brauschlauch LONG LIFE und Handbrause mit Antikalk-System  
 FR Mélangeur douche extérieur sur plac avec pomme de douche anticalcare démontable, flexible LONG LIFE et douchette anticalcare  
 EN Floor mounted shower mixer with checkable anti-lime overhead shower, LONG LIFE flexible hose and anti-lime hand shower  
 ES Monobloco para ducha externa con columna a pavimento, rociador antical, flexible LONG LIFE y ducha antical  
 RU Напольный смеситель для душа с регулируемым верхним душем с защитой от известковых отложений, шлангом «LONG LIFE» и ручным душем с защитой от накипи

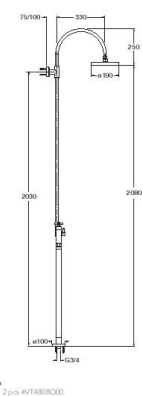

S1 cromato

2 pcs #V748/8C00

**EV 456**



IT Miscelatore termostatico per doccia esterno con colonna greviola, soffione anticalcare ispezionabile, doccetta anticalcare con supporto scomparevole e flessibile LONG LIFE  
 DE Thermostat-Brausebatterie Aufputz mit schwenkbarem Rohr, Kopfbrause mit Antikalk-System, Brauschlauch LONG LIFE, Handbrause mit Antikalk-System und Gleitschieber  
 FR Colonne de douche orientable thermostatique avec pomme de douche anticalcare démontable, douchette anticalcare avec curseur réglable et flexible LONG LIFE  
 EN External thermostatic shower mixer with turning column pipe, checkable anti-lime overhead shower, anti-lime hand shower with slide rail and LONG LIFE flexible hose  
 ES Termostato para ducha externo con columna giratoria, rociador antical inspeccionable, ducha antical con soporte deslizante y flexible LONG LIFE  
 RU Внешний термостатический смеситель для душа с поворотной колонной, верхним душем ручным душем с защитой от известковых отложений со стойкой для регулировки по высоте и шлангом «LONG LIFE»

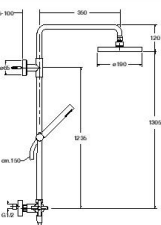

S1 cromato

13 nero opaco / 24 bianco opaco / 34 oro rosa spazzolato / 46 oro rosa lucido / 52 oro giallo / 72 cromo nero lucido / 75 cromo nero spazzolato / 92 ottone antical spazzolato / 80 metallic lucido / 77 metallic spazzolato

2 pcs #CR206/9C00

2 pcs #CR36/5C00

**EV 117**



IT Set completo per miscelatore bicomando doccia da incasso con soffione anticalcare ispezionabile  
 DE Unterputz Zweigriff Brausebatterie inkl. Einbaukörper, mit Kopfbrause mit Antikalk-System  
 FR Mélangeur douche encastré complet avec pomme de douche anticalcare démontable  
 EN Complete concealed shower mixer with checkable anti-lime overhead shower  
 ES Kit completo mezclador bimoto ducha de empotrar con rociador antical inspeccionable  
 RU Полный комплект скрытого смесителя для душа с регулируемым верхним душем с защитой от известковых отложений

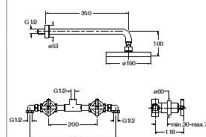

S1 cromato / 13 nero opaco / 24 bianco opaco / 34 oro rosa spazzolato / 46 oro rosa lucido / 52 oro giallo / 72 cromo nero lucido / 75 cromo nero spazzolato / 92 ottone antical spazzolato

2 pcs #V7472N00

**EV 161**



IT Set completo per miscelatore bicomando doccia da incasso con soffione anticalcare ispezionabile  
 DE Unterputz 3-Loch Brausebatterie inkl. Einbaukörper mit Brausestange, Brauschlauch LONG LIFE, Handbrause mit Antikalk-System mit Wischleitzick und Kopfbrause mit Antikalk-System  
 FR Mélangeur douche encastré complet avec barre, flexible LONG LIFE, douchette anticalcare inclinée et pomme de douche anticalcare démontable  
 EN Complete 3 hole concealed shower mixer with sliding bar, LONG LIFE flexible hose, skewed anti-lime hand shower and anti-lime checkable overhead shower  
 ES Kit completo mezclador bimoto ducha de empotrar con barra, flexible LONG LIFE, ducha antical orientable y rociador antical inspeccionable  
 RU Полный комплект скрытого смесителя для душа на 3 отверстия с подвижными элементами регулировки по высоте, шлангом «LONG LIFE», скошенным ручным душем с защитой от накипи и регулируемым верхним душем с защитой от известковых отложений

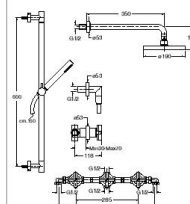

S1 cromato / 13 nero opaco / 24 bianco opaco / 34 oro rosa spazzolato / 46 oro rosa lucido / 52 oro giallo / 72 cromo nero lucido / 75 cromo nero spazzolato / 92 ottone antical spazzolato / 80 metallic lucido / 77 metallic spazzolato

2 pcs #V7472N00

**EV 666**



IT Set da esterno per miscelatore monocomando progressivo doccia CS 535 con piastra in ABS  
 DE Unterputz Braue Einhandmischer inkl. Einbaukörper mit progressiver Kartusche und Abdeckplatte aus ABS  
 FR Façade externe pour mitigeur douche cartouche progressive 1 sortie pour micrométrie CS 535 avec plaque en ABS  
 EN Progressive shower mixer external parts for CS 535 with ABS plate  
 ES Kit exterior mezclador monocomando progresivo ducha CS 535 con placa en ABS  
 RU Наружные части прогрессивного смесителя для душа для CS 535

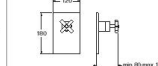

S1 cromato

2 pcs #CR206/9C00

Set da incasso CS 535 pagina 16 / Unterputz-Einbaukörper CS 535 Seite 16 / Mixeur à encastrer CS 535 page 16 / Comandato body CS 535 page 16 / Cuerpo de empotrar CS 535 page 16 / Встраиваемый элемент CS 535 с.р. 16

S1 cromo-romano / 00 grigio-raw / 02 bianco-white / 03 luce blu-light blue / 06 luce bianca-light white / 13 nero opaco-black mat / 24 bianco opaco-white mat / 28 inox-stainless steel / 34 oro rosa spazzolato-brushed rose gold / 46 oro rosa lucido-polished rose gold / 52 oro giallo-yellow gold / 53 ottone naturale-natural brass / 72 cromo nero lucido-polished black chrome / 75 cromo nero spazzolato-brushed black chrome / 77 metallic spazzolato-brushed metallic / 80 metallic lucido-polished metallic / 86 sfumato-shaded / 92 ottone antical spazzolato-brushed old brass



Exclusive

EV 669



IT Set da esterno per miscelatore monocomando progressivo doccia/vasca CS 535 con deviatore 2 uscite e piastra in ABS  
 DE Fertigmontageset Warmen/Brause-Einhandmischer mit progressiver Kartusche für Einbautürger CS 535 mit 2 Wege Umsteller und Abdeckplatte aus ABS  
 FR Façade externe pour mitigeur douche/bain douche cartouche progressive 2 sorties pour mécanisme CS 535 et plaque en ABS  
 EN Progressive bath/shower mixer external parts for CS 535 with 2 outlet diverter and ABS plate  
 ES Kit exterior para mezclador monocomando progresivo baño/ducha CS 535 con deviator 2 salidas y placa en ABS  
 RU Внешние части прогрессивного смесителя для ванны/душа с переключателем 2 выходами для CS 535

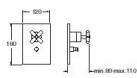

9CR2206-K200

S1 cromato

Set di accessori CS 535 pag. 16  
 Universal-Einhandmischer CS 535 Seite 16  
 Mixe à un bras CS 535 page 16  
 Comandato body CS 535 page 16  
 Смесител с едно ръка CS 535 pagina 16  
 Вспомогательные элементы CS 535 стр. 16

EV 652



IT Rubinetto "acqua fredda" a muro da 1/2"  
 DE Auslaufventil 1/2" nur Kaltwasseranschluss  
 FR Robinet mural "eau froide" 1/2"  
 EN 1/2" wall mounted "cold water" tap  
 ES Grifo "agua fría" a pared de 1/2"  
 RU Кран холодной воды 1/2" для настенного монтажа

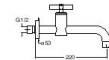

9V16A81-D00

S1 cromato

EV 618



IT Rubinetto d'arresto da 1/2"  
 DE Absperrventil 1/2"  
 FR Robinet d'arrêt 1/2"  
 EN 1/2" stopcock  
 ES Clave de cierre de 1/2"  
 RU Запорный кран 1/2"

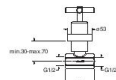

9V1472-K000

S1 cromato 13 nero opaco 34 oro rosa spazzolato 46 oro rosa lucido  
 S2 oro giallo 72 cromo nero lucido 75 cromo nero spazzolato 92 ottone antico 80 metallic lucido 77 metallic spazzolato

EV 619



IT Rubinetto d'arresto da 3/4"  
 DE Absperrventil 3/4"  
 FR Robinet d'arrêt 3/4"  
 EN 3/4" stopcock  
 ES Clave de cierre de 3/4"  
 RU Запорный кран 3/4"

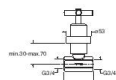

9V1434-D000

S1 cromato 13 nero opaco 34 oro rosa spazzolato 46 oro rosa lucido  
 S2 oro giallo 72 cromo nero lucido 75 cromo nero spazzolato 92 ottone antico 80 metallic lucido 77 metallic spazzolato

170 S1 cromato-chrome / 00 grigio-raw / 02 bianco-white / 03 luce blu-light blue / 06 luce bianca-light white / 13 nero opaco-black mat / 24 bianco opaco-white mat / 28 inox-stainless steel / 34 oro rosa spazzolato-brushed rose gold / 46 oro rosa lucido-polished rose gold / 52 oro giallo-yellow gold / 53 ottone naturale-natural brass / 72 cromo nero lucido-polished black chrome / 75 cromo nero spazzolato-brushed black chrome / 77 metallic spazzolato-brushed metallic / 80 metallic lucido-polished metallic / 86 sfumato-shaded / 92 ottone antico spazzolato-brushed old brass

Exclusive



IT Versione per il mercato tedesco  
 DE Ausführung für den deutschen Markt  
 FR Version pour le marché allemand  
 EN Version for the German market  
 ES Versión para el mercado alemán  
 RU версия для азиатского

171 S1 cromato-chrome / 00 grigio-raw / 02 bianco-white / 03 luce blu-light blue / 06 luce bianca-light white / 13 nero opaco-black mat / 24 bianco opaco-white mat / 28 inox-stainless steel / 34 oro rosa spazzolato-brushed rose gold / 46 oro rosa lucido-polished rose gold / 52 oro giallo-yellow gold / 53 ottone naturale-natural brass / 72 cromo nero lucido-polished black chrome / 75 cromo nero spazzolato-brushed black chrome / 77 metallic spazzolato-brushed metallic / 80 metallic lucido-polished metallic / 86 sfumato-shaded / 92 ottone antico spazzolato-brushed old brass