

# GLOBO

(It's)  
Design Time



Forty3



# Forty3

design CreativeLab +

Dalle linee decise dell'architettura moderna e ispirata all'essenzialità nasce Forty3, una linea completa di lavabi, sanitari e arredi.

Il disegno si caratterizza per le sue forme lineari e contemporanee.

I lavabi sono disponibili per installazione sospesa, da appoggio, da incasso, semincasso, sottopiano e per mobile.

I sanitari sospesi includono la versione da 52 e 57 cm di profondità, ma anche quella da 43 cm pensata per spazi ridotti.

I sanitari a terra, disponibili nelle misure 52 e 57 cm, sono i primi presenti sul mercato con l'innovativo sistema FISSAGGIOGHOST®, che consente di eliminare i fori di fissaggio, migliorando notevolmente l'estetica del prodotto.

Il sistema VASOMULTI® e BIDETMULTI® e' proposto nella versione a pavimento da 57 cm.

*Forty3 has been created by matching the decisive features of contemporary architecture and essentiality. It is a comprehensive selection of washbasins, WC and furniture. Its design is characterized by linear and contemporary shapes. All washbasins can be installed in different ways: wall-hung, sit-on, recessed, semi-recessed, under-top and on furniture installations. Wall-hung WC include both the version of 52 and 57 cm deep and the version of 43 cm created for small spaces.*

*The Floor-mounted version, available in the 52 and 57 cm sizes, is the first and leading-edge item on the market to have the innovative hidden fixing system FISSAGGIOGHOST®, which enables to eliminate all fixing holes, improving considerably the aesthetics of the product.*

*VASOMULTI® and BIDETMULTI® system is available in the floor-mounted version of 57 cm.*

## Indice Index

### p. 02

Lavabi sospesi e per mobile  
*Wall-hung and furniture basins*

### p. 16

Lavabi sottopiano, incasso, semincasso  
*Under-top, recessed, semi-recessed basins*

### p. 22

Lavabi da appoggio  
*Sit-on basins*

### p. 28

Sanitari sospesi  
*Wall-hung WC and bidet*

### p. 34

Piccolo ma grande  
*Small but great*

### p. 38

Bidet 43 con erogazione acqua dalla ceramica  
*Bidet 43 cm with water supplying from ceramic*

### p. 40

VASOGHOST® e BIDETGHOST®

### p. 44

FISSAGGIOGHOST® invisibile  
*FISSAGGIOGHOST® Hide fix*

### p. 48

VASOGHOST® monoblocco  
*VASOGHOST® close couple WC*

### p. 50

Orinatoio  
*Urinal*

### p. 52

Informazioni tecniche e finiture arredo  
*Technical information and furniture*

### p. 54

Parte tecnica e listino prezzi  
*Technical section and pricelist*

### p. 68

Colori e finiture mobili  
*Furniture colors and finishes*



# Lavabi sospesi e per mobile

## Wall-hung and furniture basins

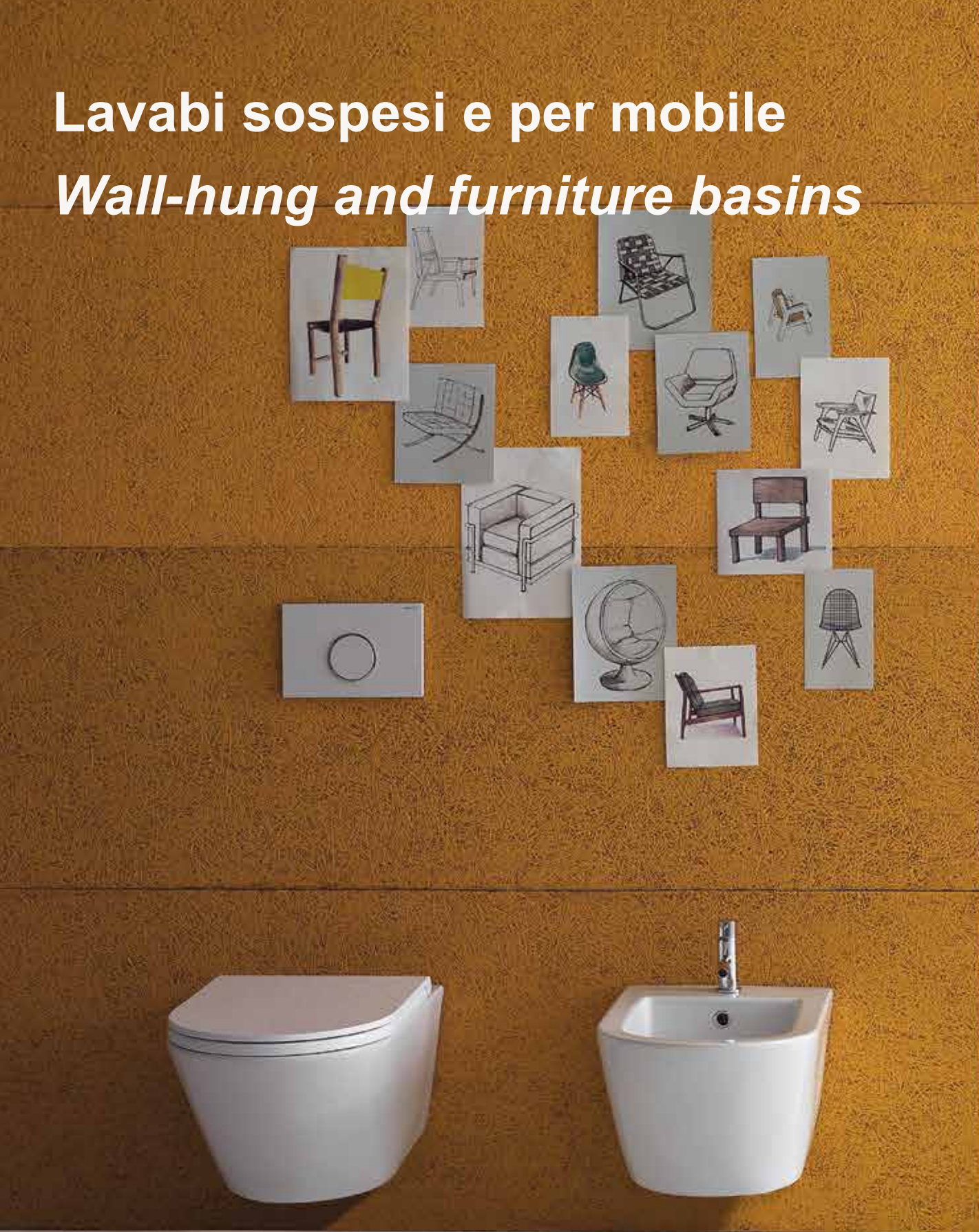

### FOM1X904

Base sospesa laminato salice 904 con due cassetti completa di lavabo doppia vasca Cod. FO125.BI  
Wall-hung base salice 904 laminate with two drawers, double sink basin Cod. FO125.BI included  
125.47.h50



**FO125.BI**  
**Lavabo doppia vasca sospeso**  
*Wall-hung basin with double sink*  
**125.47**



Lavabo 125 a doppia vasca predisposto monoforo. Con foro troppo pieno.  
 Installazione sospesa o su mobile. Completo di fissaggi.  
*Basin arranged one tap hole 125cm with double basin, provided with overflow hole. Wall-hung or on furniture installation. Fixing kit included.*

**FOM1X**  
**Base sospesa con due cassetti completa di lavabo**  
*Wall-hung base with two drawer, basin included*  
**125.47.h50**



Base 125 con due cassetti completa di lavabo Cod. FO125.BI.  
*Base 125 with two drawers, basin included Cod. FO125.BI.*

**FO060.BI**  
**Lavabo sospeso**  
*Wall-hung basin*  
**60.47**



Lavabo 60 predisposto monoforo. Con foro troppo pieno.  
 Installazione sospesa. Completo di fissaggi.  
*Basin arranged one tap hole 60cm, provided with overflow hole. Wall-hung installation. Fixing kit included.*

**FO064.BI**  
**Lavabo da incasso**  
*Recessed basin*  
**60.47**



Lavabo 60 predisposto monoforo. Con foro troppo pieno.  
 Installazione da incasso. Completo di fissaggi.  
*Basin arranged one tap hole 60cm, provided with overflow hole. Recessed installation. Fixing kit included.*

**FO100.BI**  
**Lavabo sospeso**  
*Wall-hung basin*  
**100.47**



Lavabo 100 predisposto monoforo. Con foro troppo pieno.  
 Installazione sospesa o su mobile. Completo di fissaggi.  
*Basin arranged one tap hole 100cm, provided with overflow hole. Wall-hung or on furniture installation. Fixing kit included.*

**FOM2X**  
**Base sospesa con cassetto**  
*Wall-hung base with drawer, basin included*  
**100.47.h50**



Base 100 con cassetto completa di lavabo Cod. FO100.BI.  
*Base 100 with drawer, basin included Cod. FO100.BI.*

**FO063.BI**  
**LAVABATOIO®**  
*Wall-hung basin*  
**60.50**



Lavabo 60 con vasca alta e strizzatoio, predisposto tre fori.  
 Installazione sospesa o su mobile. Con foro troppo pieno.  
*Recessed basin one tap hole arranged for three tap holes. Wall-hung installation or on furniture. Provided with overflow.*

**FOM4X**  
**Base a terra con due ante**  
*Floor mounted base with two doors basin included*  
**50.60.h85**



Base 60 con due ante completa di lavabo Cod. FO063.BI.  
*Base 60 with two doors, basin included Cod. FO063.BI.*

**FO070.BI**  
**Lavabo sospeso**  
*Wall-hung basin*  
**70.47**



Lavabo 70 predisposto monoforo. Con foro troppo pieno.  
 Installazione sospesa o su mobile. Completo di fissaggi.  
*Basin arranged one tap hole 70cm, provided with overflow hole. Wall-hung or on furniture installation. Fixing kit included.*

**FOM3X**  
**Base sospesa con cassetto**  
*Wall-hung base with drawer, basin included*  
**70.47.h50**



Base 70 con cassetto completa di lavabo Cod. FO070.BI  
*Base 70 with one drawer, basin included Cod. FO070.BI*





▲  
**FO125.BI**

Lavabo doppia vasca sospeso + portasciugamani Cod.PF125CR  
Wall-hung basin with double sink + towel rail Cod.PF125CR

125.47





▲  
**FO100.BI**

Lavabo sospeso + portasciugamani Cod. PF100CR  
 Wall-hung basin + towel rail Cod. PF100CR  
 100.47



▲  
**FOM2X907**

Base sospesa laminato desert 907 con cassetto completa di lavabo Cod.FO100.BI  
 Wall-hung base desert 907 laminate with drawer, basin Cod.FO100.BI included  
 100.47.h50





▲  
**FO070.BI**  
 Lavabo sospeso  
 Wall-hung basin  
 70.47

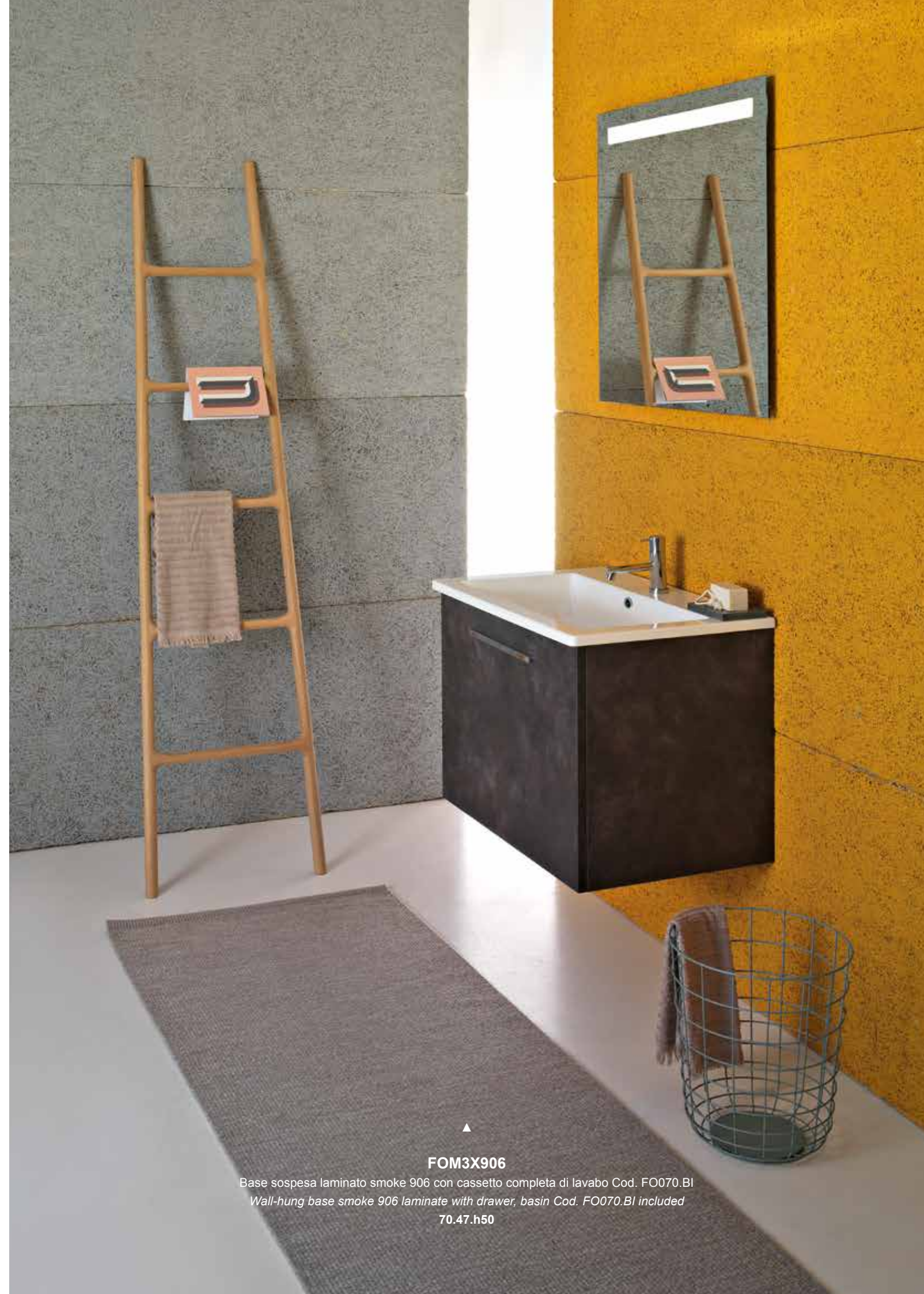

▲  
**FOM3X906**  
 Base sospesa laminato smoke 906 con cassetto completa di lavabo Cod. FO070.BI  
 Wall-hung base smoke 906 laminate with drawer, basin Cod. FO070.BI included  
 70.47.h50





▲  
**FO060.BI**  
Lavabo sospeso  
Wall-hung basin  
60.47



Il piano non è in produzione / The shelf is not in production

▲  
**FO064.BI**  
Lavabo da incasso  
Recessed basin  
60.47





▲  
**FO063.BI**  
Lavabatoio\* sospeso  
*Wall-hung basin*  
60.50



▲  
**FOM4X905**  
Base a terra laminato betulla 905 con due ante completa di lavabo Cod.FO063.BI  
*Floor mounted base betulla 905 laminate with two doors, basin Cod.FO063.BI included*  
60.50.h85



**Lavabi sottopiano,  
incasso, semincasso**  
*Under-top, recessed,  
semi-recessed basins*

Il piano non è in produzione / The shelf is not in production

**SC043.BI**  
Lavabo sottopiano  
*Under-top basin*  
60.37



Lavabo sottopiano 60. Con foro troppopieno. Completo di fissaggi.  
*Under-top basin 60cm. Provided with overflow. Fixing kit included.*

**FO058.BI**  
Lavabo da incasso  
*Recessed basin*  
58.42



Lavabo da incasso 58 con foro troppo pieno.  
*Recessed basin 58cm provided with overflow.*

**FO055.BI**  
Lavabo semincasso  
*Semi-recessed basin*  
55.47



Lavabo semincasso 55 monoforo predisposto a tre fori. Con foro troppo pieno  
*Semi-recessed basin 55cm one hole, arranged for three tap holes.*  
*Provided with overflow hole.*

◀  
**SC043.BI**  
Lavabo sottopiano  
*Under-top basin*  
60.37









Il piano non è in produzione / The shelf is not in production

▲  
**FO058.BI**  
Lavabo da incasso  
*Recessed basin*  
58.42



Il piano non è in produzione / The shelf is not in production

▲  
**FO055.BI**  
Lavabo semincasso  
*Semi-recessed basin*  
55.47





# Lavabi da appoggio

## Sit-on basins

Il piano non è in produzione / The shelf is not in production

**FO062.BI**  
Lavabo da appoggio  
*Sit-on basin*  
60.37



Lavabo 60 da appoggio senza foro troppo pieno.  
Per rubinetteria a muro o su piano  
*Sit-on basin 60cm, with no overflow hole.*  
*Suitable for wall mounted taps or on counter.*

**FO050.BI**  
Lavabo da appoggio  
*Sit-on basin*  
50.37



Lavabo 50 da appoggio senza foro troppo pieno.  
Per rubinetteria a muro o su piano.  
*Sit-on basin 50cm, with no overflow hole.*  
*Suitable for wall mounted taps or on counter.*

**FO061.BI**  
Lavabo da appoggio  
*Sit-on basin*  
60.35



Lavabo 60 da appoggio senza foro troppo pieno.  
Per rubinetteria a muro o su piano.  
*Sit-on basin 60cm, with no overflow hole.*  
*Suitable for wall mounted taps or on counter.*

**FO035.BI**  
Lavabo da appoggio  
*Sit-on basin*  
ø 35



Lavabo ø 35 da appoggio senza foro troppo pieno.  
Per rubinetteria a muro o su piano  
*Sit-on basin ø 35, with no overflow hole.*  
*Suitable for wall mounted taps or on counter.*



**FO062.BI**  
Lavabo da appoggio  
*Sit-on basin*  
60.37





▲  
**FO061.BI**  
Lavabo da appoggio  
*Sit-on basin*  
60.35



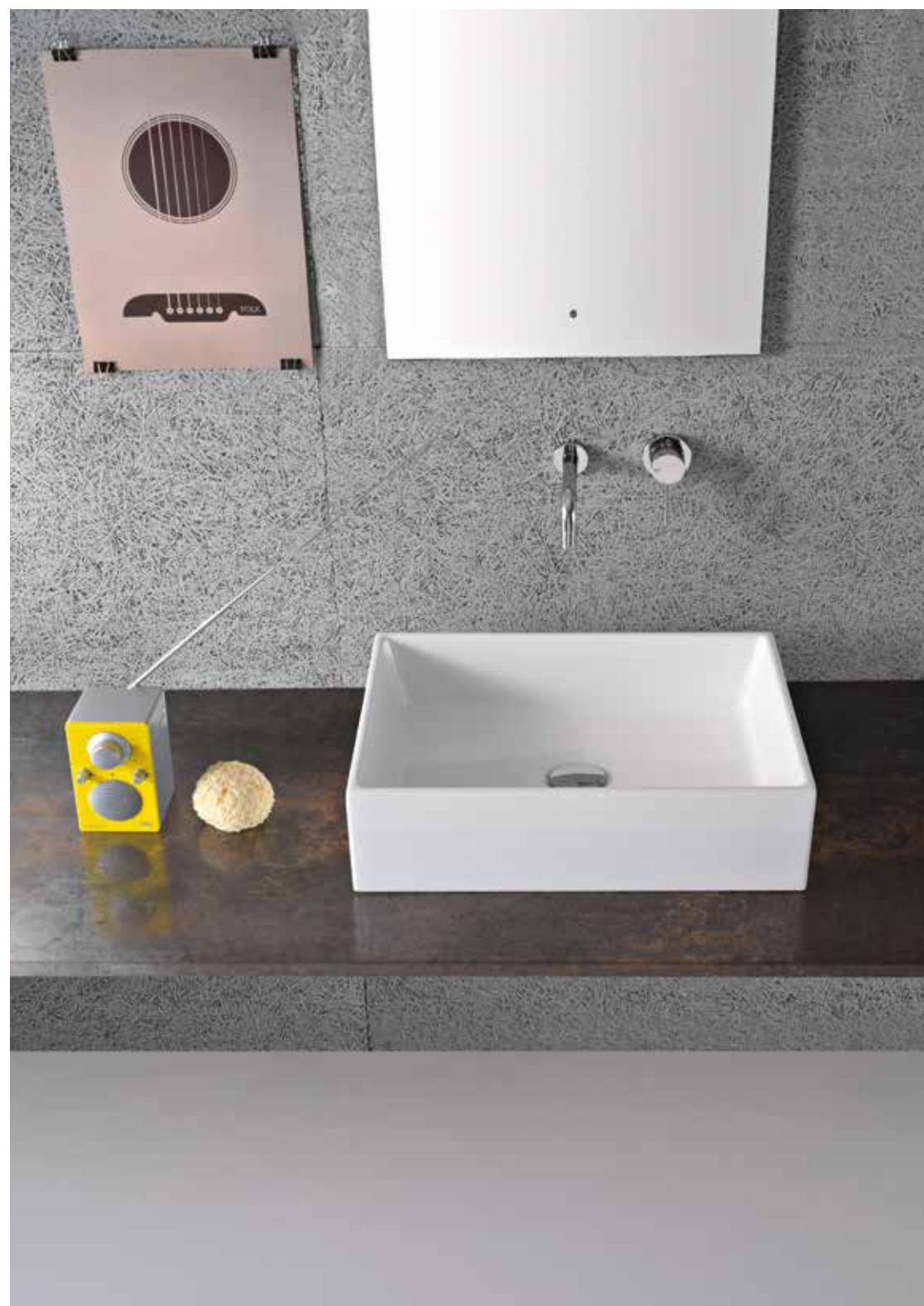

Il piano non è in produzione / The shelf is not in production

▲  
**FO050.BI**  
 Lavabo da appoggio  
*Sit-on basin*  
 50.37



▲  
**FO035.BI**  
 Lavabo da appoggio  
*Sit-on basin*  
 ø 35

Il piano non è in produzione / The shelf is not in production



# Sanitari sospesi

## Wall-hung WC and bidet



**FOS02.BI**  
Vaso sospeso  
Wall-hung WC  
57.36



Vaso sospeso con sistema di fissaggio dal basso nascosto.  
Scarico 4,5 / 3 Lt.  
Wall-hung WC provided with lower hidden fixing system. Drain 4,5 / 3 Lt.

**FOS09.BI**  
Bidet sospeso  
Wall-hung bidet  
57.36



Bidet sospeso monoforo con sistema di fissaggio dal basso nascosto.  
Wall-hung bidet one hole provided with lower hidden fixing system.

**FOS03.BI**  
Vaso sospeso  
Wall-hung WC  
52.36



Vaso sospeso con sistema di fissaggio dal basso nascosto.  
Scarico 4,5 / 3 Lt.  
Wall-hung WC provided with lower hidden fixing system. Drain 4,5 / 3 Lt.

**FOS10.BI**  
Bidet sospeso  
Wall-hung bidet  
52.36



Bidet sospeso monoforo con sistema di fissaggio dal basso nascosto.  
Wall-hung bidet one hole provided with lower hidden fixing system.

**FOS04.BI**  
Vaso sospeso  
Wall-hung WC  
43.36



Vaso sospeso con sistema di fissaggio dal basso nascosto.  
Scarico 4,5 / 3 Lt.  
Wall-hung WC provided with lower hidden fixing system. Drain 4,5 / 3 Lt.

**FOS12.BI**  
Bidet sospeso  
Wall-hung bidet  
43.36



Bidet sospeso monoforo con sistema di fissaggio dal basso nascosto.  
Wall-hung bidet one hole provided with lower hidden fixing system.

**FOS11.BI**  
Bidet sospeso  
Wall-hung bidet  
43.36



Bidet sospeso con erogazione acqua dalla ceramica con sistema di fissaggio dal basso nascosto. Completo di rubinetto e piletta di scarico.  
Wall-hung bidet with water supplying from ceramic provided with bottom hidden fixing system. Comprehensive of tap and drain system.

**FOS03.BI - FOS10.BI**

Vaso e bidet sospesi, fissaggi nascosti  
Wall-hung WC and bidet, hidden fixing  
52.36





**FOS09.BI**

Bidet sospeso, fissaggi nascosti  
Wall-hung bidet, hidden fixing  
57.36



**FOS02.BI**

Vaso sospeso, fissaggi nascosti  
Wall-hung WC, hidden fixing  
57.36





▲  
**FOS10.BI**

Bidet sospeso, fissaggi nascosti  
*Wall-hung bidet, hidden fixing*  
52.36



▲  
**FOS03.BI**

Vaso sospeso, fissaggi nascosti  
*Wall-hung WC, hidden fixing*  
52.36

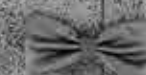



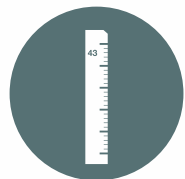

I più piccoli sanitari mai prodotti, con una profondità di soli 43 cm mantengono comunque l'ergonomicità e la comodità di un sanitario normale, grazie all'ottimizzazione dello spazio di seduta ottenuta riducendo al minimo l'area non utilizzata del WC.

*The smallest sanitaris ever produced, only 43 cm deep, which are still ergonomic and comfortable as a common WC, thanks to the optimization of the seat space obtained by minimizing the unused space of the WC.*

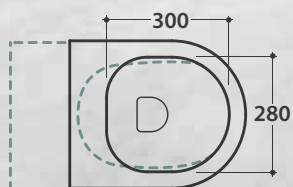

**Piccolo ma grande**  
**Small but great**



**FOS04.BI**

Vaso sospeso, fissaggi nascosti  
Wall-hung WC, hidden fixing  
43.36



**FOS12.BI**

Bidet sospeso, fissaggi nascosti  
Wall-hung bidet, hidden fixing  
43.36





▲  
**FOS04.BI**

Vaso sospeso, fissaggi nascosti  
*Wall-hung WC, hidden fixing*

43.36

▲  
**FOS11.BI**

Bidet sospeso, fissaggi nascosti,  
erogazione acqua dalla ceramica  
*Wall-hung bidet with water supplying from ceramic  
provided with bottom hidden fixing system.*

43.36



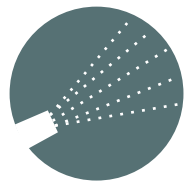

Il bidet 43 cm sospeso, è disponibile anche con erogazione acqua dalla ceramica, che consente un ulteriore plus di comodità della seduta. L'erogatore è posto nella parte frontale del bidet e il miscelatore sul lato, direttamente sulla ceramica.

*The wall-hung bidet, 43 cm deep, is available with water supplying from ceramic, which makes the seat more comfortable. The supplying is located on the front of the bidet and the tap on the side of it, directly on the ceramic.*

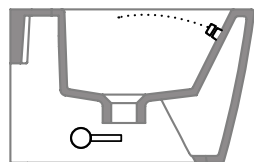

## **Bidet 43 con erogazione acqua dalla ceramica** ***Wall-hung bidet 43 with water supplying from ceramic***



### **FOS11.BI**

Bidet sospeso, fissaggi nascosti,  
erogazione acqua dalla ceramica  
*Wall-hung bidet with water supplying from ceramic  
provided with bottom hidden fixing system*





**FO001.BI**  
**VASOGHOST®**  
*Floor mounted WC*  
**57.36**



Vaso a terra con carico e scarico acqua regolabile MULTI. Scarico parete trasformabile a pavimento tramite curva tecnica fornita a richiesta. Installazione filo parete. Scarico 4,5 / 3 Lt. Completo di FISSAGGIOGHOST®.  
*Floor mounted WC with adjustable water inlet/outlet MULTI. Wall drain turning into floor drain by means of the PVC pipe supplied on demand. Back to wall installation. Drain 4,5 / 3 Lt. FISSAGGIOGHOST® fixing kit included.*

**FO009.BI**  
**BIDETGHOST®**  
*Floor mounted bidet*  
**57.36**



Bidet a terra monoforo. Carico e scarico acqua regolabile MULTI. Installazione filo parete. Completo di FISSAGGIOGHOST®.  
*Floor mounted bidet one hole. Adjustable water inlet / outlet MULTI. Back to wall installation. FISSAGGIOGHOST® fixing kit included.*

**FO002.BI**  
**VASOGHOST®**  
*Floor mounted WC*  
**52.36**



Vaso a terra scarico a parete. Trasformabile a pavimento tramite la curva tecnica VA079 fornita a richiesta. Installazione filo parete. Scarico 4,5 / 3 Lt. Completo di FISSAGGIOGHOST®.  
*Floor mounted WC with wall drain, turning into floor drain by means of the PVC pipe cod. VA079 supplied on demand. Back to wall installation. Drain 4,5 / 3 Lt. FISSAGGIOGHOST® fixing kit included.*

**FO010.BI**  
**BIDETGHOST®**  
*Floor mounted bidet*  
**52.36**



Bidet a terra monoforo. Installazione filo parete. Completo di FISSAGGIOGHOST®.  
*Floor mounted bidet one hole. Back to wall installation. FISSAGGIOGHOST® fixing kit included.*





**FO001.BI**

Vaso a terra, completo di FISSAGGIOGHOST®  
Floor mounted WC, FISSAGGIOGHOST® fixing included  
57.36



**FO009.BI**

Bidet a terra, completo di FISSAGGIOGHOST®  
Floor mounted bidet, FISSAGGIOGHOST® fixing included  
57.36







Forty3 è la prima collezione esistente sul mercato in cui il sistema di fissaggio dei vasi e bidet a terra è completamente nascosto, grazie al sistema brevettato FISSAGGIOGHOST®, sviluppato ed ingegnerizzato da Ceramica Globo.

I sanitari vengono così saldamente fissati al pavimento lasciando il design del pezzo perfettamente intatto senza interruzioni, migliorando notevolmente l'estetica.

*Forty3 is the first collection on the market which has the fixing system of floor-mounted WC and bidet completely hidden, thanks to a patented system, called FISSAGGIOGHOST®, created and developed by Ceramica Globo. Therefore, the sanitaries are firmly fixed, keeping intact and without interruptions the design of the product, improving considerably the aesthetics of the item.*

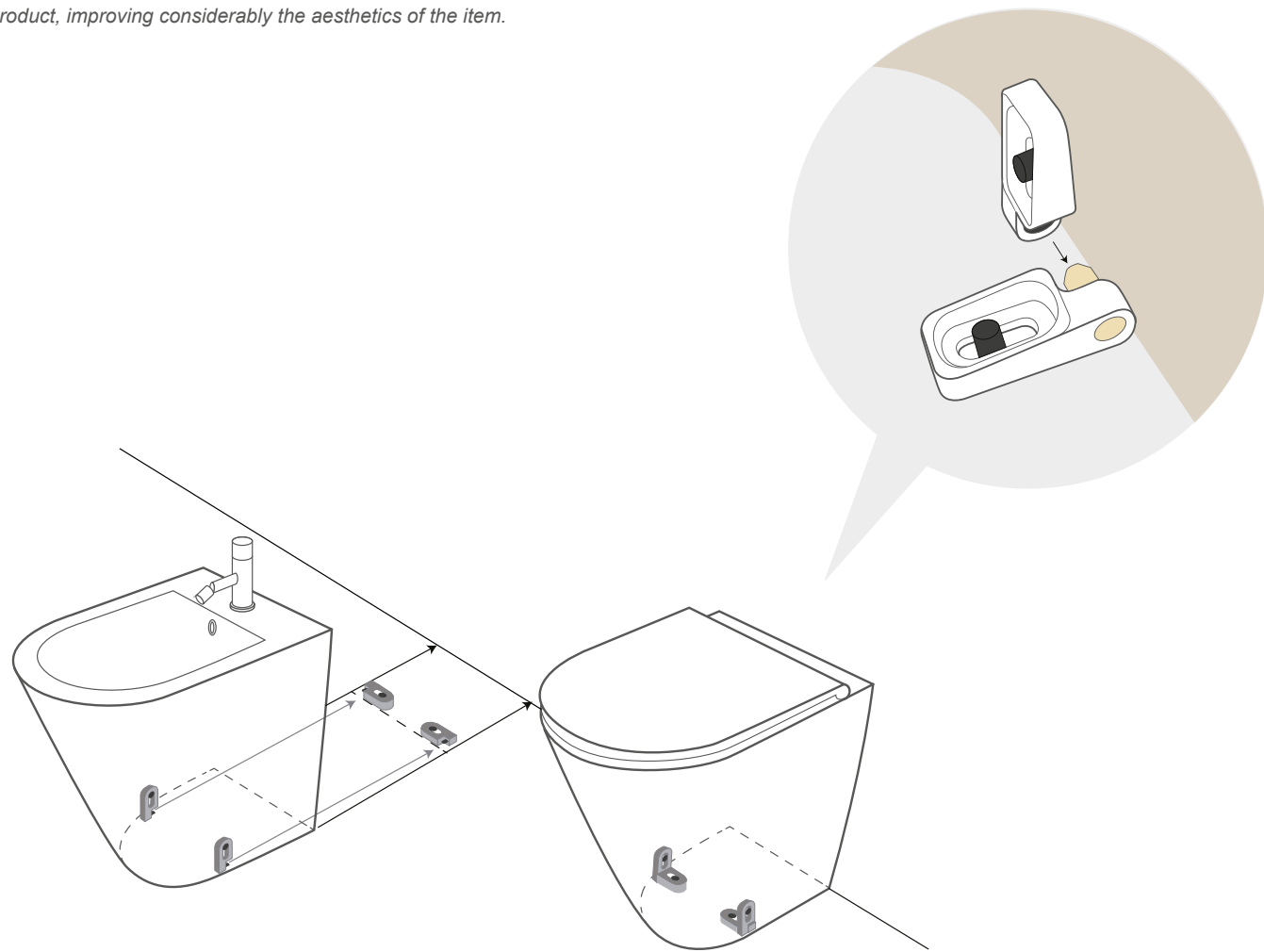

# FISSAGGIOGHOST®

## Fissaggio invisibile

### Hide fix



▲  
**FO002.BI**

Vaso a terra, completo di FISSAGGIOGHOST®  
Floor mounted WC, FISSAGGIOGHOST® fixing included

52.36





**FO002.BI**

Vaso a terra, completo di FISSAGGIOGHOST®  
Floor mounted WC, FISSAGGIOGHOST® fixing included  
52.36



**FO010.BI**

Bidet a terra, completo di FISSAGGIOGHOST®  
Floor mounted bidet, FISSAGGIOGHOST® fixing included  
52.36



**VASOGHOST®**  
**monoblocco**  
**close couple WC**



**FO003.BI**  
**VASOGHOST® monoblocco**  
**VASOGHOST® close couple WC**  
**58.36**



Vaso monoblocco scarico a parete. Trasformabile a pavimento tramite la curva tecnica VA079 fornita a richiesta.  
Scarico 4,5 / 3 Lt. Completo di FISSAGGIOGHOST®.  
*Close couple WC with wall drain, turning into floor drain by means of the PVC pipe cod. VA079 supplied on demand.*  
*Drain 4,5 / 3 Lt. FISSAGGIOGHOST® fixing kit included.*





# Orinatoio

## Urinal



**FO029.BI**  
Orinatoio sospeso  
*Wall-hung urinal*  
37.33



Orinatoio sospeso.  
Completo di FISSAGGIOGHOST® e sistema di scarico e carico acqua  
*Wall-hung urinal, provided with FISSAGGIOGHOST® fixing kit,  
water supply and drainage system.*

**FO030.BI**  
Orinatoio sospeso  
con fori per coperchio  
*Wall-hung urinal with holes for cover*  
37.33



Orinatoio sospeso con fori per coperchio.  
Completo di FISSAGGIOGHOST® e sistema di scarico e carico acqua  
*Wall-hung urinal with holes for cover,  
provided with FISSAGGIOGHOST® fixing kit,  
water supply and drainage system.*





## Informazioni tecniche e arredo FORTY3

### Technical Information and furniture FORTY3



#### Materiali di costruzione e garanzie

Il materiale con cui sono prodotti i nostri mobili è l'**Idropan**, un pannello in particelle nobilitato ed idrofugo, quindi un prodotto garantito per altissima **resistenza all' acqua** secondo gli standard stabiliti dalla normativa UNI EN 120/92 con grado di dilatazione 6/8%, rispettando la stessa normativa in materia di **emissione formaleide (Classe E1)**.

Il pannello di Idropan si può distinguere da un pannello non idrofugo osservando il collante usato nell' impasto delle particelle. Infatti, quello idrofugo si presenta di colore verde, al contrario, se la colla non ha colore saremo di fronte ad un pannello non idrofugo e quindi assolutamente non resistente all'acqua.

I pannelli di Idropan, **ecocompatibili** in quanto composti da particelle ricavate da materiale di riciclo, sono inoltre interamente **Made in Italy**.

#### Construction materials and warranties

*Our furniture is produced by using **Idropan**, an hydrophobic panel made by noble particles, therefore it is a guaranteed product thanks to its **water resistant** peculiarity, according to the standards established by the regulation UNI EN 120/92. This product has a dilation degree of 6/8 % and fulfils the above-mentioned regulation in the field of **formaldehyde emission (E1 Class)**.*

*IDROPAN can be differentiate from a non-hydrophobic panel simply by seeing the glue used during the mixture of particles; the hydrophobic glue is green, whereas, if the glue is colorless, we are dealing with a non-hydrophobic panel totally non-waterproof.*

*Moreover, these IDROPAN panels are **ecofriendly** because all the particles are obtained by using recycled materials, and they are absolutely **Made in Italy**.*



#### Sistema di aggancio dei mobili sospesi con sicurezza anti sgancio.

Tutti i nostri mobili sospesi sono corredati di un sistema di aggancio assolutamente innovativo in metallo e di spessore ridotto (solo 10 mm) che garantisce elevata resistenza a carichi pesanti (**fino a 100 kg** per angolo del mobile). Questo sistema di aggancio è testato TÜV LGA secondo le norme europee EN 14749, EN14688 e ISO 7170.

Il sistema di aggancio che avviene per mezzo di due viti consente una **regolazione orizzontale di 19mm e verticale di 22mm**.

Le due piastrine di ancoraggio alla parete sono dotate di un **innovativo e rivoluzionario sistema anti sgancio** che si attiva automaticamente al momento dell'aggancio del reggibase e che impedisce qualsiasi distacco accidentale del mobile sospeso.

Il gancio del reggibase entrando nel foro della piastrina sposta una linguetta d'acciaio, poi scendendo per agganciarsi, fa tornare la linguetta nella posizione iniziale, impedendo al gancio di poter risalire e di sganciarsi dalla piastrina.

#### Hook system of wall-hung furniture with unfasten safety

*All wall-hung furniture are provided with a groundbreaking hook system, completely made of steel with reduced thickness (only 10 mm) which assures high resistance to heavy loads (**up to 100 kg per corner of the furniture**). The above-mentioned hook system is tested TÜV LGA according to the European regulations EN 14749, EN14688 and ISO 7170.*

*Through two screws, this hook system, enables both **horizontal and vertical adjustments of 19mm and a vertical one of 22 mm**, respectively.*

*The two anchoring plates are provided with an **innovative and leading-edge anti-unfasten system** which is activated automatically when the base holder is hooked into and prevents from any accidental detachment of the wall-hung furniture.*

*The hook of the base holder, entering in the hole of the plate, moves the steel flap. Then, going down to hook up the flap, the grapple goes back to the original position and prevents the hook from going up again and unfasten itself from the plate.*



#### Sistema di apertura e chiusura rallentata dei cassetti.

Tutti i nostri mobili con cassetto estraibile hanno il sistema di **chiusura rallentata**; le guide sono certificate per 40000 cicli di apertura e chiusura secondo normativa UNI 8604:2005 e certificate inoltre per la verifica della resistenza secondo normativa UNI 8605:2005.



#### Soft-close opening and closing system of the drawer

*All furniture with pullout drawer are provided with **soft-close system**. This is possible thanks to high-quality tracks, certified for 40000 cycles of opening and closing according to the Regulation UNI 8604:2005 and resistance according to the regulation UNI 8605:2005.*

#### Specchio contenitore

Lo specchio contenitore è costruito con gli **stessi materiali dei mobili** e quindi ne presenta le stesse caratteristiche, così come anche la colonna laterale. Lo specchio è certificato per la resistenza alla corrosione secondo norma UNI ISO 9227/93 e resistenza a fasi di umidità e secco secondo norma PTP 25/95.

#### Cabinet mirror

*It is produced by using **the same materials of furniture** and for this reason has the same features as well as the side column. The mirror is certified for the resistance to corrosion according to the regulation UNI ISO 9227/93 and for the resistance to the alternation of humidity and dry stages pursuant to the regulation PTP 25/95.*



#### Specchiera

Le specchiere possono essere AGC Glaverbel® o Saint Gobain®, entrambe "New Generation" con argentatura ecologica.

**Il telaio**, o meglio, piastra supporto di aggancio, è realizzata in lamiera elettrozincata.

**Il supporto / copertura della strip Led**, è invece, in lamiera preverniciata bianca.

**L' impianto di illuminazione** è composto da :  
- Strip led da 14, 40 W al mt. ( n° 60 led 50 / 50 al mt.) 12 VDC - 4000 / 4500 K Lumen / metro n° 1080. Alimentatore elettronico da 15 W 12 VDC - 230 V - 50 Hz. Interruttore Touch.

#### Mirror

*Our mirrors depend on the availability or on the provider, on the brands AGC Glaverbel® or Saint Gobain®, both "New Generation" with ecofriendly plating.*

***The structure**, an hook plate is made with galvanised metal sheet. **The sustain/cover of the strip Led** is made with white pre-varnished metal sheet.*

***The lighting plant** is composed by:  
Strip Led of 14,40 W per meter (n. 60 led 50/50 per meter) 12 VDC- 4000/4500 K  
Lumen/ metro n. 1080. Power supply of 15 W 12 VDC- 230 V- 50 Hz. Touch switch*



**Lavabo FORTY3 125.47**

Lavabo 125 a doppia vasca predisposto monoforo. Con foro troppo pieno. Installazione sospesa o su mobile. Completo di fissaggi.  
*Basin arranged one tap hole 125cm with double basin, provided with overflow hole. Wall-hung installation or on base. Fixing kit included.*

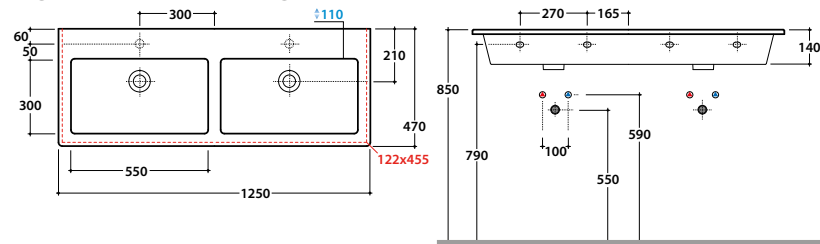

Disponibilita' NOVEMBRE 2014  
 Available on NOVEMBER 2014



cm 125x47 h14 Pallet Italia pz. 8 Pallet export pz. 13 Europallet pz. 10 kg 35

**Portasciugamani cromato**

Portasciugamani in ottone cromato.  
*Brass chromium-plated towel rail.*

FO125.BI

PF125CR

**Lavabo FORTY3 100.47**

Lavabo 100 predisposto monoforo. Con foro troppo pieno. Installazione sospesa o su mobile. Completo di fissaggi.  
*Basin arranged one tap hole 100cm, provided with overflow hole. Wall-hung installation or on base. Fixing kit included.*

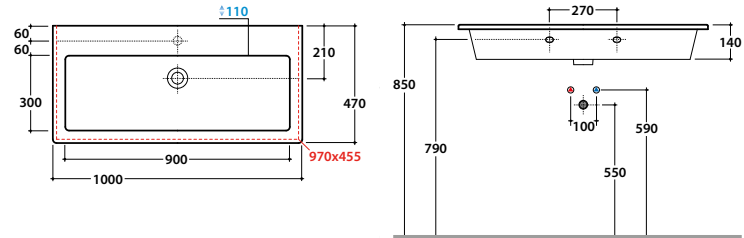

Disponibilita' NOVEMBRE 2014  
 Available on NOVEMBER 2014



cm 100x47 h14 Pallet Italia pz. 10 Pallet export pz. 15 Europallet pz. 9 kg 26

**Portasciugamani cromato**

Portasciugamani in ottone cromato.  
*Brass chromium-plated towel rail.*

FO100.BI

PF100CR

**Lavabo FORTY3 70.47**

Lavabo 70 predisposto monoforo. Con foro troppo pieno. Installazione sospesa o su mobile. Completo di fissaggi.  
*Basin arranged one tap hole 70cm, provided with overflow hole. Wall-hung installation or on base. Fixing kit included.*

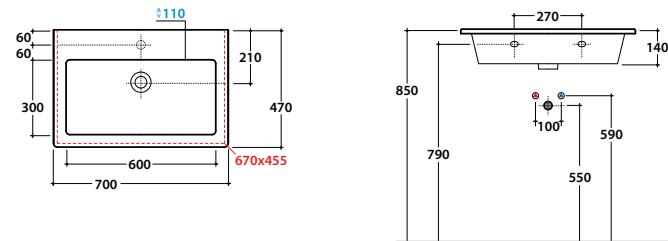

cm 70x47 h14 Pallet Italia pz. 12 Pallet export pz. 20 Europallet pz. 17 kg 19

**Portasciugamani cromato**

Portasciugamani in ottone cromato.  
*Brass chromium-plated towel rail.*

FO070.BI

PF070CR

**Lavabo FORTY3 60.47**

Lavabo 60 predisposto monoforo. Con foro troppo pieno. Installazione sospesa o su mobile. Completo di fissaggi.  
*Basin arranged one tap hole 60cm, provided with overflow hole. Wall-hung installation or on base. Fixing kit included.*

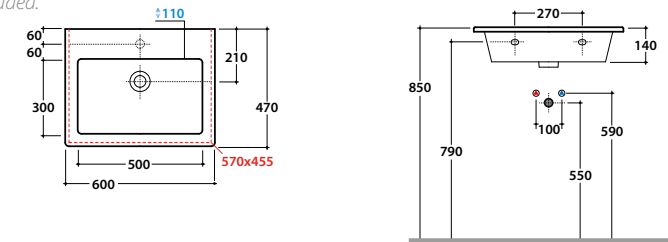

cm 60x47 h14 Pallet Italia pz. 18 Pallet export pz. 27 Europallet 21 kg 17

**Portasciugamani cromato**

Portasciugamani in ottone cromato.  
*Brass chromium-plated towel rail.*

FO060.BI

PF060CR

**Lavabo FORTY3 60.47**

Lavabo 60 predisposto monoforo. Con foro troppo pieno. Installazione incasso. Completo di fissaggi.  
*Basin arranged one tap hole 60cm, provided with overflow hole. Recessed installation. Fixing kit included.*



cm 60x47 h14 Pallet Italia pz. 18 Pallet export pz. 27 Europallet pz. 21 kg 17

FO064.BI

**Lavabo FORTY3 70.27**

Lavabo 70 predisposto monoforo diaframmato sui due lati. Senza foro troppo pieno. Installazione sospesa. Completo di fissaggi.  
*Basin 70cm arranged for one tap hole on both sides. No overflow. Wall-hung mounted. Fixing kit included.*

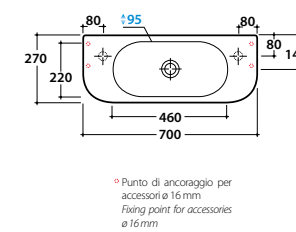

Punto di ancoraggio per accessori a 16 mm  
 Fixing point for accessories a 16 mm



cm 70x27 h12 Pallet Italia pz. 30 Pallet export pz. 54 Europallet pz. 42 kg 14

**Portasciugamani cromato**

Portasciugamani in ottone cromato.  
*Brass chromium-plated towel rail.*

SCT70.BI

PC7027

**Lavabo FORTY3 55.27**

Lavabo 55 predisposto monoforo diaframmato. Senza foro troppo pieno. Installazione sospesa. Completo di fissaggi.  
*Basin 55cm arranged for one tap hole. No overflow. Wall-hung mounted. Fixing kit included.*

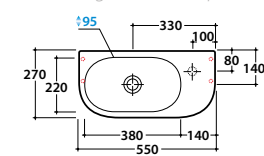

Punto di ancoraggio per accessori a 16 mm  
 Fixing point for accessories a 16 mm



cm 55x27 h12 Pallet Italia pz. 44 Pallet export pz. 66 Europallet pz. 54 kg 10

**Portasciugamani cromato**

Portasciugamani in ottone cromato.  
*Brass chromium-plated towel rail.*

SCT55.BI

PC5527

**Lavabatoio® FORTY3 60.50**

Lavabo 60 con vasca alta e strizzatoio, predisposto tre fori. Installazione sospesa o su mobile. Con foro troppo pieno. Fissaggi inclusi  
*Recessed basin one tap hole arranged for three tap holes. Provided with overflow. Fixing kit included.*

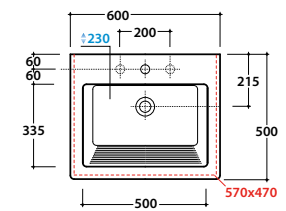

Disponibilita' GENNAIO 2015  
 Available on JANUARY 2015



cm 60x50 h40 Pallet Italia pz. 8 Pallet export pz. 14 Europallet pz. 9 kg 26

**Lavabo semincasso FORTY3 55.47**

Lavabo semincasso monoforo predisposto a tre fori. Con foro troppo pieno.  
*Semi-recessed basin one hole, arranged for three tap holes. Provided with overflow hole.*

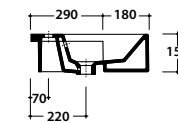
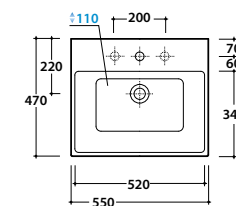

Disponibilita' GENNAIO 2015  
 Available on JANUARY 2015



cm 55x47 h11 Pallet Italia pz. 27 Pallet export pz. 36 Europallet pz. 21 kg 17



**Lavabo appoggio FORTY3 60.37** Lavabo 60 da appoggio senza foro troppo pieno. Per rubinetteria a muro o su piano  
*Sit-on basin 60, with no overflow hole. Suitable for wall mounted taps or on counter.*

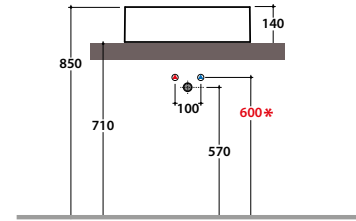
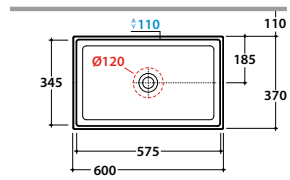

\* Per rubinetto su piano/For taps mounted on corner top



cm60x37h14 PalletItalia pz.30 Palletexport pz.60 Europallet pz.36 kg 16

**Piletta scarico libero** Piletta a scarico libero per lavabi senza troppo pieno  
*Drain for basin provided with no overflow.*

**Lavabo appoggio FORTY3 50.37** Lavabo 50 da appoggio senza foro troppo pieno. Per rubinetteria a muro o su piano  
*Sit-on basin 50, with no overflow hole. Suitable for wall mounted taps or on counter.*

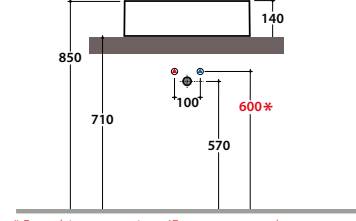
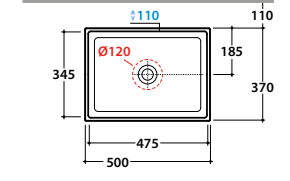

\* Per rubinetto su piano/For taps mounted on corner top



cm50x37h14 PalletItalia pz.27 Palletexport pz.40 Europallet pz.36 kg 12

**Piletta scarico libero** Piletta a scarico libero per lavabi senza troppo pieno  
*Drain for basin provided with no overflow.*

**Lavabo appoggio FORTY3 60.35** Lavabo 60 da appoggio senza foro troppo pieno. Per rubinetteria a muro o su piano  
*Sit-on basin 60, with no overflow hole. Suitable for wall mounted taps or on counter.*

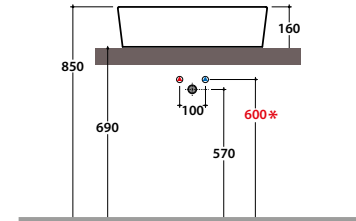
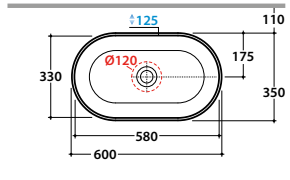

\* Per rubinetto su piano/For taps mounted on corner top



cm35x35h16 PalletItalia pz.30 Palletexport pz.50 Europallet pz.36 kg 15

**Piletta scarico libero** Piletta a scarico libero per lavabi senza troppo pieno  
*Drain for basin provided with no overflow.*

**Lavabo appoggio FORTY3 60.40** Lavabo 60 da appoggio senza foro troppo pieno. Per rubinetteria a muro o su piano  
*Sit-on basin 60, with no overflow hole. Suitable for wall mounted taps or on counter. Fixing kit included*

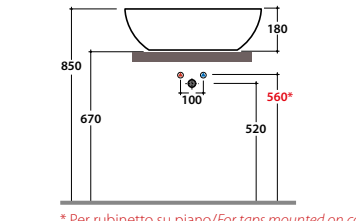
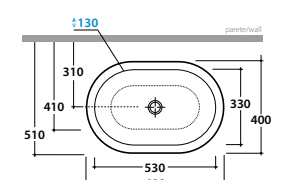

\* Per rubinetto su piano/For taps mounted on corner top



cm60x40h18 PalletItalia pz.30 Palletexport pz.44 Europallet pz.34 kg 15

**Piletta scarico libero** Piletta a scarico libero per lavabi senza troppo pieno  
*Drain for basin provided with no overflow.*

FO062.BI

**Lavabo appoggio FORTY3 42.42**



Lavabo 42 da appoggio senza foro troppo pieno. Per rubinetteria a muro o su piano  
*Sit-on basin 42, with no overflow hole. Suitable for wall mounted taps or on counter. Fixing kit included*

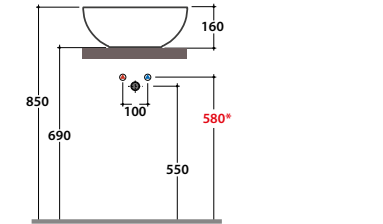
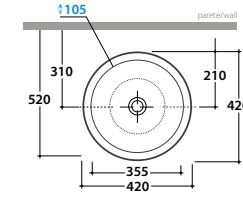

\* Per rubinetto su piano/For taps mounted on corner top



cm60x40h16 PalletItalia pz.42 Palletexport pz.60 Europallet pz.38 kg 13

**Piletta scarico libero** Piletta a scarico libero per lavabi senza troppo pieno  
*Drain for basin provided with no overflow.*

FI024CR

FI024CR

FO050.BI

**Lavabo appoggio FORTY3 35.35**



Lavabo 35 da appoggio senza foro troppo pieno. Per rubinetteria a muro o su piano  
*Sit-on basin 35, with no overflow hole. Suitable for wall mounted taps or on counter. Fixing kit included*

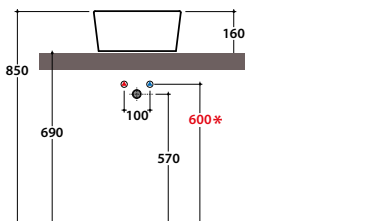
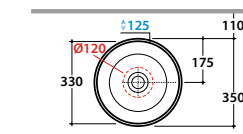

\* Per rubinetto su piano/For taps mounted on corner top



cm35x35h16 PalletItalia pz.42 Palletexport pz.60 Europallet pz.38 kg 9

**Piletta scarico libero** Piletta a scarico libero per lavabi senza troppo pieno  
*Drain for basin provided with no overflow.*

FI024CR

FI024CR

FO061.BI

**Lavabo incasso FORTY3 58.42**



Lavabo incasso con troppo pieno.  
*Recessed basin provided with overflow.*

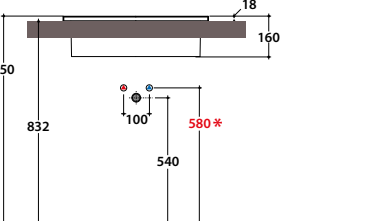
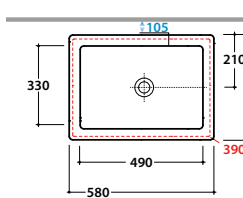

\* Per rubinetto su piano/For taps mounted on corner top



cm58x42h16 PalletItalia pz.27 Palletexport pz.36 Europallet pz.38 kg 17

**Piletta scarico libero** Piletta a scarico libero per lavabi senza troppo pieno  
*Drain for basin provided with no overflow.*

FI024CR

FO058.BI

SC012.BI

SC012.BO

SC012.AR

**Lavabo sottopiano FORTY3 60.37**



Lavabo sottopiano. Con foro troppopieno. Completo di fissaggi.  
*Under-top basin. Provided with overflow. Fixing kit included.*

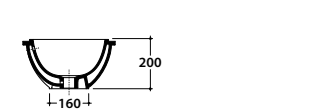
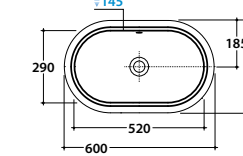

cm60x37h20 PalletItalia pz.30 Palletexport pz.44 Europallet pz.35 kg 34,5

**Piletta scarico libero** Piletta a scarico libero per lavabi senza troppo pieno  
*Drain for basin provided with no overflow.*

FI024CR

SC043.BI



**Base 125 FORTY3 con due cassetti completa di lavabo**

Base 125 con due cassetti completa di lavabo Cod. FO125.BI.  
Base 125 with two drawers, basin included Cod. FO125.BI.

**FOM1X**  
Salice 904  
Betulla 905  
Smoke 906  
Desert 907

Laccati  
Laminati  
rovere  
laccati

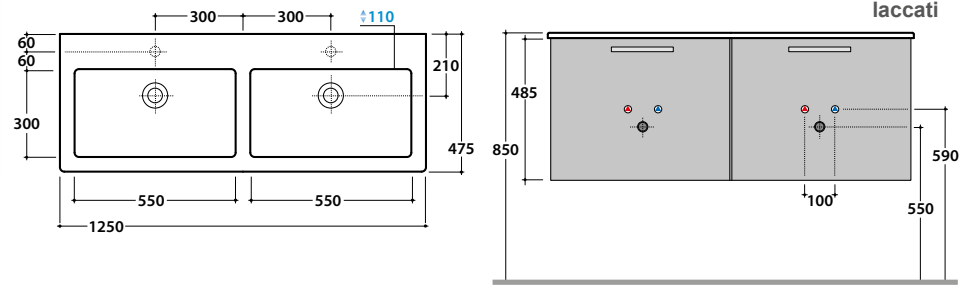

Disponibilita' NOVEMBRE 2014  
Available on NOVEMBER 2014



cm 125x47 h50

kg 72

**Specchio 120 filo lucido**

Specchiera cm 120 filo lucido. Completa di retroilluminazione a led, interruttore a sfioramento e telaio in acciaio inox. Classe energetica A+  
Polished edge led backlight mirror 120cm with touch-switch and stainless steel frame. Energy efficiency class A+

**BPS120**

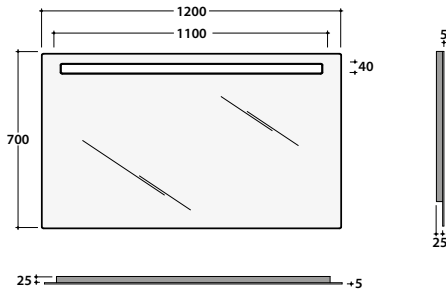

cm 120x70

kg 8,9

**Base 100 FORTY3 con cassetto completa di lavabo**

Base 100 con cassetto completa di lavabo Cod. FO100.BI.  
Base 100 with drawer, basin included Cod. FO100.BI.

**FOM2X**  
Salice 904  
Betulla 905  
Smoke 906  
Desert 907

Laccati  
Laminati  
rovere  
laccati

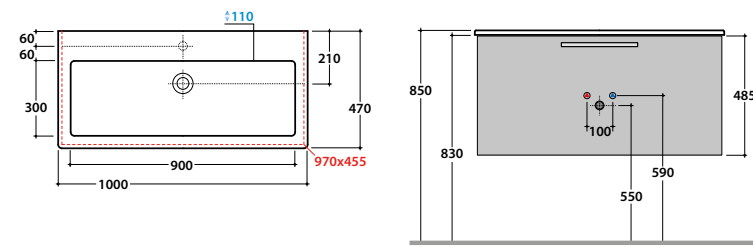

Disponibilita' NOVEMBRE 2014  
Available on NOVEMBER 2014



cm 100x70 h50

kg 59

**Specchiera 100 filo lucido**

Specchiera cm 100 filo lucido. Completa di retroilluminazione a led, interruttore a sfioramento e telaio in acciaio inox. Classe energetica A+  
Polished edge led backlight mirror 100cm with touch-switch and stainless steel frame. Energy efficiency class A+

**BPS100**

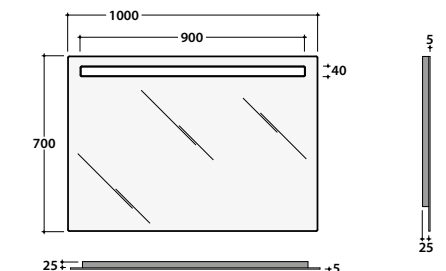

cm 100x70

kg 10,5

**Base 70 FORTY3 con cassetto completa di lavabo**

Base 70 con cassetto completa di lavabo Cod. FO070.BI.  
Base 70 with one drawer, basin included Cod. FO070.BI.

**FOM3X**  
Salice 904  
Betulla 905  
Smoke 906  
Desert 907

Laccati  
Laminati  
rovere  
laccati

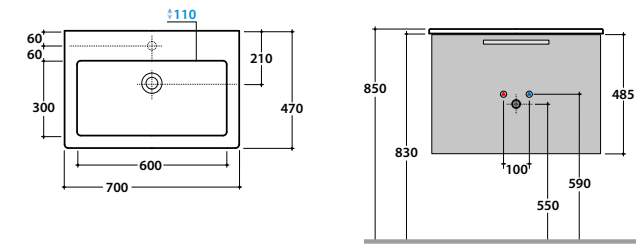

Disponibilita' NOVEMBRE 2014  
Available on NOVEMBER 2014



cm 70x47x50

kg 47

**Specchiera 70 filo lucido**

Specchiera cm 70 filo lucido. Completa di retroilluminazione a led, interruttore a sfioramento e telaio in acciaio inox. Classe energetica A+  
Polished edge led backlight mirror 70cm with touch-switch and stainless steel frame. Energy efficiency class A+

**BPS70**

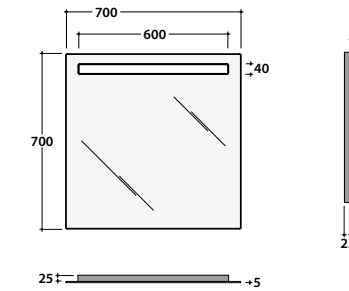
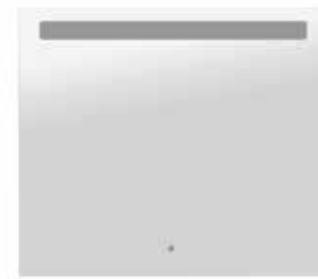

cm 70x70

kg 8

**Base 60 FORTY3 con 2 ante completa di lavabo**

Base 60 con due ante completa di lavabo Cod. FO063.BI.  
Base 60 with two doors, basin included Cod. FO063.BI.

**FOM4X**  
Salice 904  
Betulla 905  
Smoke 906  
Desert 907

Laccati  
Laminati  
rovere  
laccati

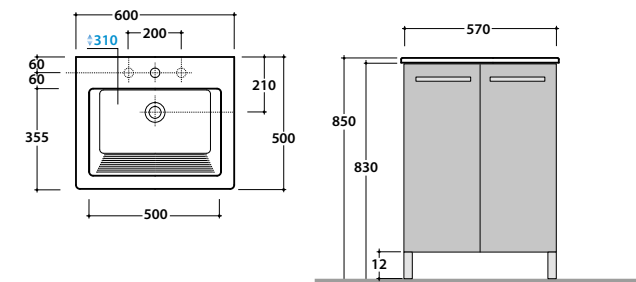

Disponibilita' GENNAIO 2015  
Available on JANUARY 2015



cm 50x60 h85

kg 60

**Specchiera 60 filo lucido**

Specchiera cm 60 filo lucido. Completa di retroilluminazione a led, interruttore a sfioramento e telaio in acciaio inox. Classe energetica A+  
Polished edge led backlight mirror 60cm with touch-switch and stainless steel frame. Energy efficiency class A+

**BPS60**

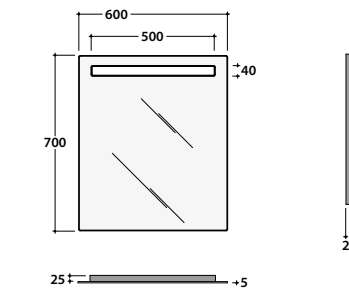

cm 60x70

kg 6,5



**Specchio contenitore**

Specchio contenitore con anta a ribalta completo di lampada.  
*Cabinet mirror with hinged door, lamp included.*

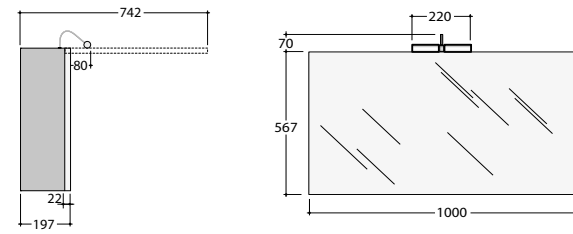

cm100x57 h19,7

**BPS**  
**Salice 904**  
**Betulla 905**  
**Smoke 906**  
**Desert 907**

**Laccati**  
**Laminati**  
**rovere**  
**laccati**

**Colonna alta**

Colonna alta a due ante (reversibile).  
*High cabinet provided with two doors (reversible opening).*

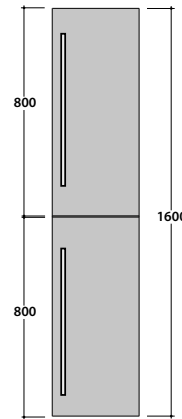
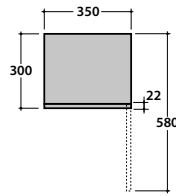

cm 35x30 h160

**BPC**  
**Salice 904**  
**Betulla 905**  
**Smoke 906**  
**Desert 907**

**Laccati**  
**Laminati**  
**rovere**  
**laccati**

**Vaso sospeso FORTY3 57.36**

Vaso sospeso con sistema di fissaggio dal basso nascosto. Scarico 4,5 / 3 Lt.  
*Wall-hung WC provided with lower hidden fixing system. Drain 4,5 / 3 Lt.*

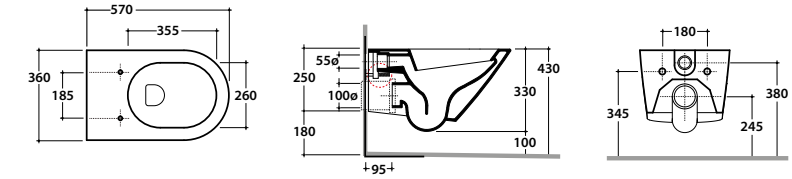

**Coprivaso**

Coprivaso in termoindurente cerniere cromate.  
*Thermo-setting seat-cover with chromium-plated hinges.*

FOS02.BI

FO019BI

**Coprivaso chiusura rallentata**

Coprivaso in termoindurente chiusura rallentata.  
*Thermo-setting seat-cover with soft-closing system.*

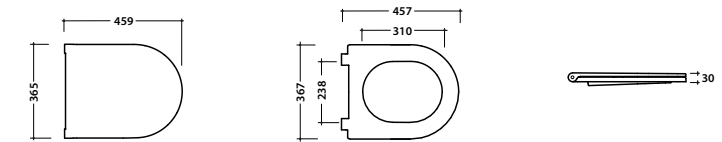

Pallet Italia pz. 90 Pallet export pz. 135 Europallet pz. 120 kg 3

FO020BI

**Riduttore flusso di scarico**

Riduttore flusso di scarico.  
*Flow reductor.*



VA132

**Bidet sospeso monoforo FORTY3 57.36**

Bidet sospeso monoforo con sistema di fissaggio dal basso nascosto.  
*Wall-hung bidet provided with lower hidden fixing system.*

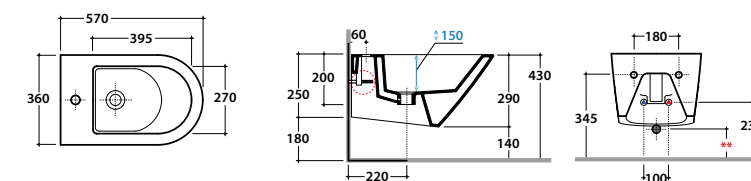

\*\* per installazione con / for installation with:  
 -silone a "S"/siphon "S": mm 140  
 -silone SFO2/siphon SFO2: mm 120



cm 57x36 Pallet Italia pz. 15 Pallet export pz. 25 Europallet pz. 20 kg 19

FOS09.BI

**Staffa di fissaggio**

Staffa di fissaggio a "L".  
*Fixing brackets for W/H sanitary.*



kg 2,5

FI002

**Protezione**

Protezione antiurto e acustica.  
*Acoustic and crash protection.*



kg 0,2

PU001



Vaso sospeso FORTY3 52.36

Vaso sospeso con sistema di fissaggio dal basso nascosto. Scarico 4,5 / 3 Lt.  
Wall-hung WC provided with lower hidden fixing system. Drain 4,5 / 3 Lt.

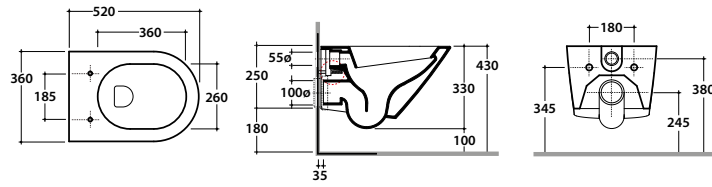

cm 52x36 Pallet Italia pz. 15 Pallet export pz. 25 Europallet pz. 20 kg 18



Coprivaso

Coprivaso in termoindurente cerniere cromate.  
Thermo-setting seat-cover with chromium-plated hinges.

Coprivaso chiusura rallentata

Coprivaso in termoindurente chiusura rallentata.  
Thermo-setting seat-cover with soft-closing system.

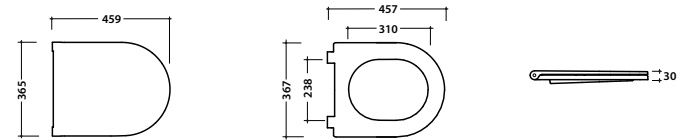

Pallet Italia pz. 90 Pallet export pz. 135 Europallet pz. 120 kg 3,5

Riduttore flusso di scarico

Riduttore flusso di scarico.  
Flow reductor.



Bidet sospeso monoforo FORTY3 52.36

Bidet sospeso monoforo con sistema di fissaggio dal basso nascosto.  
Wall-hung bidet provided with lower hidden fixing system

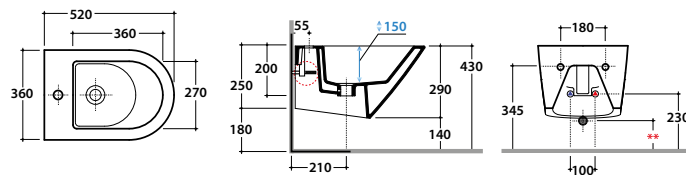

\*\* Per installazione con / For installation with:  
- Sifone a "S" / Siphon "S" - mm 40  
- Sifone SF052 / Siphon SF052 - mm 120

cm 52x36 Pallet Italia pz. 15 Pallet export pz. 25 Europallet pz. 20 kg 17



Staffa di fissaggio

Staffa di fissaggio a "L".  
Fixing brackets for W/H sanitary.



kg 2,5

Protezione

Protezione antiurto e acustica.  
Acoustic and crash protection.



kg 0,2

FOS03.BI

Vaso sospeso FORTY3 43.36

Vaso sospeso con sistema di fissaggio dal basso nascosto. Scarico 4,5 / 3 Lt.  
Wall-hung WC provided with lower hidden fixing system. Drain 4,5 / 3 Lt.

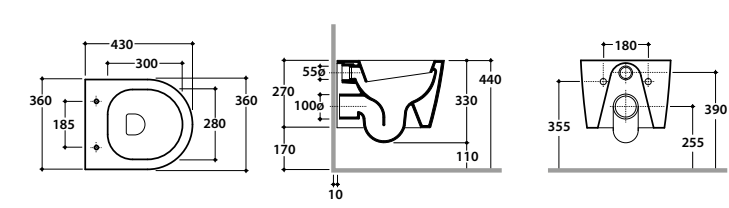

cm 43x36 Pallet Italia pz. 18 Pallet export pz. 30 Europallet pz. 20 kg 18



Coprivaso

Coprivaso in termoindurente cerniere cromate.  
Thermo-setting seat-cover with chromium-plated hinges.

Coprivaso chiusura rallentata

Coprivaso in termoindurente chiusura rallentata.  
Thermo-setting seat-cover with soft-closing system.

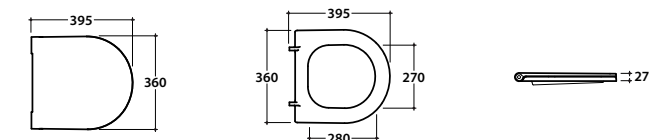

Pallet Italia pz. 90 Pallet export pz. 135 Europallet pz. 120 kg 3,5

Riduttore flusso di scarico

Riduttore flusso di scarico.  
Flow reductor.



Bidet sospeso FORTY3 43.36

Bidet sospeso con erogazione da ceramica con sistema di fissaggio dal basso nascosto.  
Completo di rubinetto e piletta di scarico  
Wall-hung bidet provided with lower hidden fixing system. Integrated water dispenser.

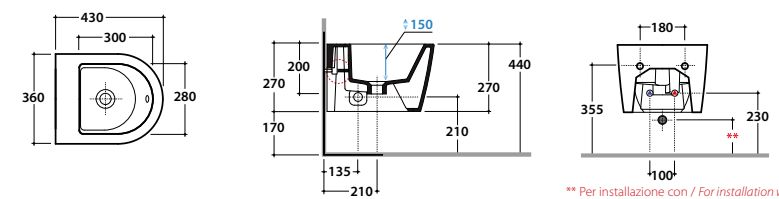

\*\* Per installazione con / For installation with:  
- Sifone a "S" / Siphon "S" - mm 40  
- Sifone SF052 / Siphon SF052 - mm 120

cm 54x36x42 Pallet Italia pz. 18 Pallet export pz. 30 Europallet pz. 20 kg 18



Bidet sospeso FORTY3 43.36

Bidet sospeso monoforo con sistema di fissaggio dal basso nascosto.  
Wall-hung bidet provided with lower hidden fixing system.

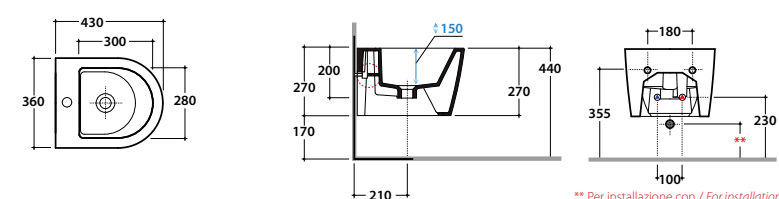

\*\* Per installazione con / For installation with:  
- Sifone a "S" / Siphon "S" - mm 40  
- Sifone SF052 / Siphon SF052 - mm 120

cm 54x36x42 Pallet Italia pz. 18 Pallet export pz. 30 Europallet pz. 20 kg 17



Staffa di fissaggio

Staffa di fissaggio a "L".  
Fixing brackets for W/H sanitary.



kg 2,5

Protezione

Protezione antiurto e acustica.  
Acoustic and crash protection.



kg 0,2

FOS04.B1

FO019BI

FO020BI

VA132

FOS10.BI

FI002

PU001

FO021BI

FO022BI

VA132

FOS11.BI

FOS12.BI

FI002

PU001



**VASOGHOST® a terra FORTY3 57.36**



**Coprivaso**

**Coprivaso chiusura rallentata**



**Curva tecnica \***



**Curva tecnica \***



**Curva tecnica \***



**Raccordo eccentrico \*\***



**Raccordo a parete**



**Riduttore flusso di scarico**



**BIDETGHOST® a terra FORTY3 57.36**



**Sifone**

64 Globo

Vaso a terra con carico e scarico acqua regolabile MULTI. Scarico parete trasformabile a pavimento tramite curva tecnica fornita a richiesta. Installazione filo parete. Scarico 4,5 / 3 Lt. Completo di FISSAGGIOGHOST®.

Floor mounted WC with adjustable water inlet/outlet MULTI. Wall drain turning into floor drain by means of the PVC pipe supplied on demand. Back to wall installation. Drain 4,5 / 3 Lt. FISSAGGIOGHOST® fixing kit included.

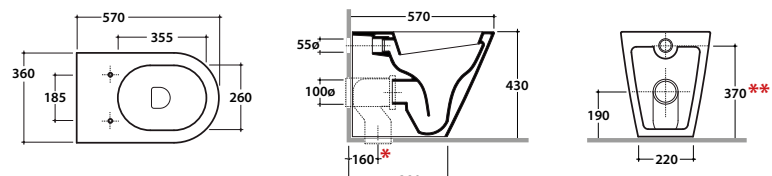

cm 57x36 Pallet Italia pz. 15 Pallet export pz. 20 Europallet pz. 16 kg 26

Coprivaso in termoindurente cerniere cromate. Thermo-setting seat-cover with chromium-plated hinges.

Coprivaso in termoindurente chiusura rallentata. Thermo-setting seat-cover with soft-closing system.

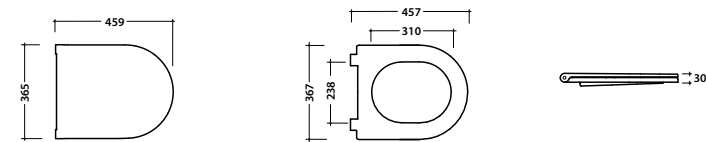

Pallet Italia pz. 90 Pallet export pz. 135 Europallet pz. 120 kg 3,5

Raccordo per scarico a pavimento regolabile da 6 a 12 cm. Elbow pipe for floor drain. Adjustable 6/12 cm.

Ø 11

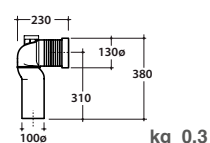

Raccordo per scarico a pavimento regolabile da 17 a 21 cm. Elbow pipe for floor drain. Adjustable 17/21 cm.

Ø 10

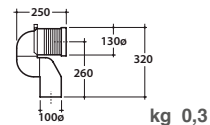

Curva tecnica per lo scarico a pavimento regolabile da 13 a 16 cm. Elbow pipe for floor drain. Adjustable 13/16 cm.

Ø 10

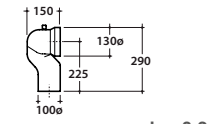

Raccordo eccentrico per carico acqua cm. 38,5 o 35,5. Pipe for drain 38,5/35,5 cm.

Ø 4

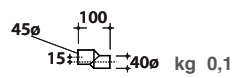

Raccordo a parete per scarico a parete cm. 35. Pipe for wall drain 35cm.

Ø 11

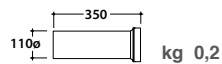

Riduttore flusso di scarico. Flow reductor.

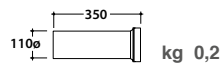

FO001.B1

FO019BI

FO020BI

VA077

VA078

VA079

VA086

VA076

VA132

FO009.BI

FI016

**VASOGHOST® a terra FORTY3 52.36**



**Coprivaso**

**Coprivaso chiusura rallentata**



**Curva tecnica**



**Raccordo a parete**



**Riduttore flusso di scarico**



**BIDETGHOST® a terra FORTY3 52.36**



**Sifone**

Vaso a terra scarico a parete. Trasformabile a pavimento tramite la curva tecnica VA079 fornita a richiesta. Installazione filo parete. Scarico 4,5 / 3 Lt. Completo di FISSAGGIOGHOST®. Floor mounted WC with wall drain, turning into floor drain by means of the PVC pipe cod. VA079 supplied on demand. Back to wall installation. Drain 4,5 / 3 Lt. FISSAGGIOGHOST® fixing kit included.

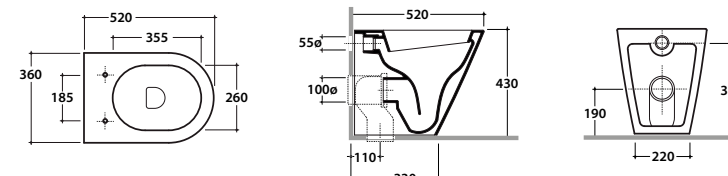

cm 54x36x42 Pallet Italia pz. 15 Pallet export pz. 20 Europallet pz. 16 kg 24

Coprivaso in termoindurente cerniere cromate. Thermo-setting seat-cover with chromium-plated hinges.

Coprivaso in termoindurente chiusura rallentata. Thermo-setting seat-cover with soft-closing system.

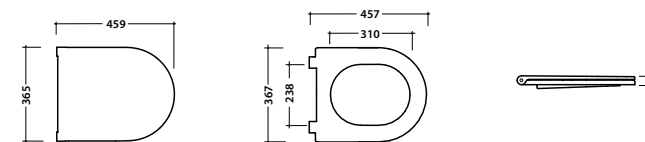

Pallet Italia pz. 90 Pallet export pz. 135 Europallet pz. 120 kg 3,5

Curva tecnica per lo scarico a pavimento regolabile da 12 a 15 cm. Elbow pipe for floor drain. Adjustable 12/15 cm.

Ø 10

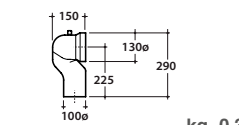

Raccordo per scarico a parete cm. 35. Pipe for wall drain 35cm.

Ø 11

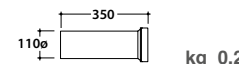

Riduttore flusso di scarico. Flow reductor.

Bidet a terra monoforo. Installazione filo parete. Completo di FISSAGGIOGHOST®. Floor mounted bidet one hole. Back to wall installation. FISSAGGIOGHOST® fixing kit included.

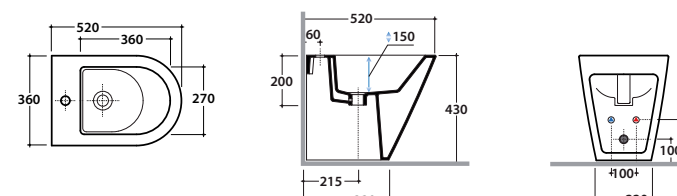

cm 54x36x42 Pallet Italia pz. 15 Pallet export pz. 20 Europallet pz. 16 kg 23

Sifone installazione facilitata. Easy installation siphon.

kg 0,5

FO002.BI

FO019BI

FO020BI

VA077

VA079

VA076

VA132

FO010.BI

FI016



**VASOGHOST®  
monoblocco FORTY3 58.36**



Disponibilita' GENNAIO 2015  
Available on JANUARY 2015



Monoblocco scarico a parete. Trasformabile a pavimento tramite la curva tecnica VA079 fornita a richiesta. Scarico 4,5 / 3 Lt. Completo di FISSAGGIQGHOST®  
Close couple WC with wall drain, turning into floor drain by means of the PVC pipe cod. VA079 supplied on demand. Drain 4,5 / 3 Lt. Provided with FISSAGGIQGHOST® fixing kit

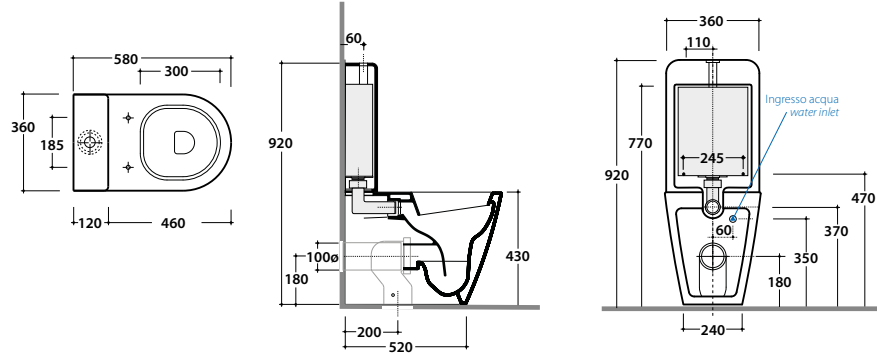

cm 58x36 h87 Pallet Italia pz. 15 Pallet export pz. 20 Europallet pz. 26 kg 27

FO003.BI

**Orinatoio sospeso  
FORTY3 37.33**



Disponibilita' GENNAIO 2015  
Available on JANUARY 2015



Orinatoio sospeso. Completo di fissaggi e sistema di scarico e carico acqua.  
Completo di FISSAGGIQGHOST®  
Wall-hung urinal, provided with fixing kit, water supply and drainage system.  
Provided with FISSAGGIQGHOST® fixing kit

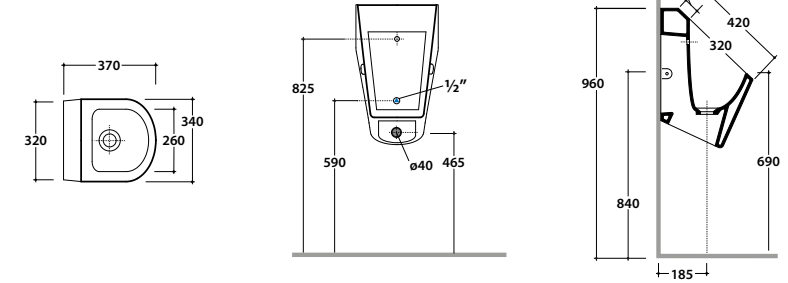

cm 37x33 h57 Pallet Italia pz. 18 Pallet export pz. 30 Europallet pz. 20 kg 18

FO029.BI

**Cassetta monoblocco  
con guscio anticondensa**



Cassetta monoblocco completa di meccanismo di scarico, guscio in plastica anticondensa e tubo di scarico. Ingresso acqua dal basso sx  
Close couple cistern provided with flushing mechanism, plastic anti-moisture shell and drain pipe. rear LH water inlet.

cm 36x12 h44 Pallet Italia pz. 30 Pallet export pz. 55 Europallet 34 kg 11

FO0081X

**Coprivaso**

Coprivaso in termoindurente cerniere cromate.  
Thermo-setting seat-cover with chromium-plated hinges.

FO021BI

**Coprivaso chiusura rallentata**

Coprivaso in termoindurente chiusura rallentata.  
Thermo-setting seat-cover with soft-closing system.

FO022.BI

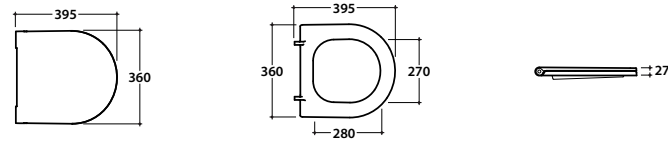

Pallet Italia pz. 90 Pallet export pz. 135 Europallet pz.120 kg 3

**Curva tecnica**

Raccordo per scarico a pavimento regolabile da 7 a 18 cm.  
Elbow pipe for floor drain. Adjustable 7/18 cm.

VA077



Ø 11

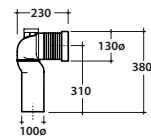

kg 0,3

**Curva tecnica**

Curva tecnica per lo scarico a pavimento.  
Elbow pipe for floor drain.

VA079



Ø 10

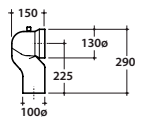

kg 0,3

**Curva tecnica**

Raccordo per scarico a pavimento regolabile da 18 a 25 cm.  
Elbow pipe for floor drain. Adjustable 18/25 cm.

VA078



Ø 10

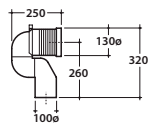

kg 0,3

**Raccordo a parete**

Raccordo per scarico a parete cm. 35  
Pipe for wall drain 35cm.

VA076



Ø 11

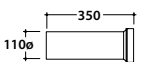

kg 0,2

**Orinatoio sospeso  
per coperchio  
FORTY3 37.33**



Disponibilita' GENNAIO 2015  
Available on JANUARY 2015



Orinatoio sospeso con fori per coperchio. Completo di fissaggi e sistema di scarico e carico acqua.  
Completo di FISSAGGIQGHOST®  
Wall-hung urinal with holes for cover, provided with fixing kit, water supply and drainage system.  
Provided with FISSAGGIQGHOST® fixing kit

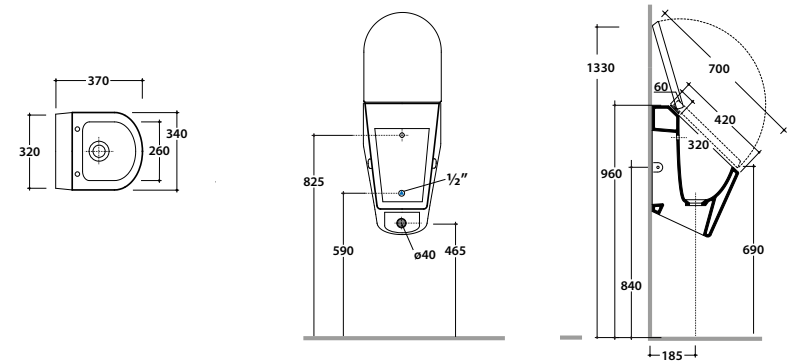

cm 37x33 h57 Pallet Italia pz. 18 Pallet export pz. 30 Europallet pz. 20 kg 18

FO030.BI

**Coperchio**

Coperchio in termoindurente cerniere cromate.  
Thermo-setting cover with chromium-plated hinges.

FO023BI

**Coperchio chiusura rallentata**

Coperchio in termoindurente chiusura rallentata.  
Thermo-setting cover with soft-closing system.

FO024BI



cm 42x34 h3 Pallet Italia pz. 90 Pallet export pz. 135 Europallet pz. 120 kg 2



**COLORI E FINITURE MOBILI FORTY3 / COLORS and FINISHINGS of THE FURNITURE**

**Laccati  
Lacquered**

Bianco Ceramico Lucido 001

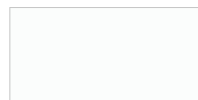

Sabbia Lucido 018  
Sabbia Opaco 017

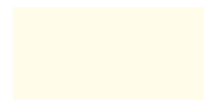

Canapa Lucido 136  
Canapa Opaco 135



Lilla Lucido 052  
Lilla Opaco 051



Zucca Lucido 152  
Zucca Opaco 151



Grigio nuvola Lucido 156  
Grigio nuvola Opaco 155



Cemento Lucido 160  
Cemento Opaco 159



Bianco Lucido 066  
Bianco Opaco 065



Cipria Lucido 016  
Cipria Opaco 015

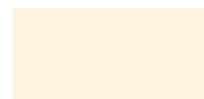

Argilla Lucido 138  
Argilla Opaco 137



Fucsia Lucido 078  
Fucsia Opaco 077



Cacao Lucido 0100  
Cacao Opaco 099



Cenere Lucido 094  
Cenere Opaco 093



Tortora Lucido 162  
Tortora Opaco 161



Sahara Lucido 042  
Sahara Opaco 041

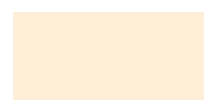

Camelia Lucido 142  
Camelia Opaco 141



Prugna Lucido 0080  
Prugna Opaco 079



Blu Lucido 026  
Blu Opaco 025



Verde Germoglio Lucido 004  
Verde Germoglio Opaco 003

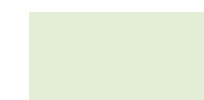

Fango Lucido 164  
Fango Opaco 163



Crema Lucido 014  
Crema Opaco 013



Indaco Lucido 082  
Indaco Opaco 081



Bordeaux Lucido 056  
Bordeaux Opaco 055



Cobalto Lucido 084  
Cobalto Opaco 083



Verde Salvia Lucido 008  
Verde Salvia Opaco 007



Mousse Lucido 166  
Mousse Opaco 165



Polvere Lucido 132  
Polvere Opaco 131

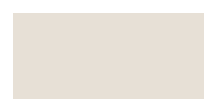

Orchidea Lucido 144  
Orchidea Opaco 143



Passione Lucido 148  
Passione Opaco 147



Pervinca Lucido 154  
Pervinca Opaco 153



Notte fonda Lucido 158  
Notte fonda Opaco 157



Cioccolato Lucido 168  
Cioccolato Opaco 167



Creta Lucido 134  
Creta Opaco 133



Glicine Lucido 054  
Glicine Opaco 053



Rosso fiamma Lucido 150  
Rosso fiamma Opaco 149



Grigio Nebbia Lucido 064  
Grigio Nebbia Opaco 063



Carbone Lucido 102  
Carbone Opaco 101



Caramello Lucido 170  
Caramello Opaco 169



**Laccati metallizzati  
Metal lacquered**

Metalux Terra Bruciata 410



Metalux Champagne 406



Metalux Zaffiro 414



Metalux Turchese 405



Metalux Alluminio 402



Metalux Cioccolato 407





Laminati rovere laccati  
Laminated oak lacquered

Bianco legno 6065



Sabbia legno 6017



Canapa legno 6135



Lilla legno 6051



Zucca legno 6151



Grigio nuvola legno 6155



Cemento legno 6159



Cipria legno 6015



Argilla legno 6137



Fucsia legno 6077



Cacao legno 6099



Cenere legno 6093



Tortora legno 6161



Sahara legno 6041



Camelia legno 6141



Prugna legno 6079



Blu legno 6025



Verde germoglio legno 6003



Fango legno 6145



Crema legno 6013



Indaco legno 6081



Bordeaux legno 6055



Cobalto legno 6083



Verde salvia legno 6007



Mousse legno 6165



Polvere legno 6131



Orchidea legno 6143



Passione legno 6147



Pervinca legno 6153



Notte fonda legno 6157



Cioccolato legno 6167



Creta legno 6133



Glicine legno 6053



Rosso fiamma legno 6149



Grigio nebbia legno 6063



Carbone legno 6101



Caramello legno 6169



Laminati  
Laminate

Salice 904



Betulla 905



Smoke 906



Desert 907



Le tonalità dei colori sono da ritenersi indicative, in quanto possono variare in relazione alle modalità di stampa del catalogo.  
The colour tones are indicative, as they may change in relation to the printing method of the catalogue.

Composizione del codice

Code composition

Per ordinare l'articolo relativo agli arredi (base completa di lavabo, colonna alta e specchio contenitore) è necessario indicare il codice prodotto seguito dal codice della finitura scelta.

To order the furniture articles (base with basin included, high cabinet and cabinet mirror) it is necessary to indicate the product code followed by the code of the chosen finish.

Esempio  
Example

Base cod. FOM1X (completa di lavabo) + Finitura Bianco Ceramico Lucido 001 = FOM1X001

Base code FOM1X (basin included) + Shiny White Ceramic Finish 001 = FOM1X001



# Legenda Icone

## Icon Legend

Ceramica Globo propone un nuovo concetto di rappresentare le caratteristiche del prodotto. Un linguaggio simbolico mirato a rendere più veloce la lettura e l'acquisizione dei dettagli tecnici.

*Ceramica Globo proposes a new concept of representing product information. A symbolic language which makes easier the reading and quicker the acquisition of the technical details.*

	Predisposto monoforo diaframmato <i>Arranged for one tap hole</i>		Senza chiusura scarico <i>Without discharge closing</i>
	Monoforo <i>One tap hole</i>		Con chiusura scarico <i>With discharge closing</i>
	Nessun foro <i>No tap hole</i>		Sospeso con fissaggio nascosto ad azionamento dal basso <i>Wall-hung with lower hidden fixing system</i>
	Monoforo predisposto tre fori diaframmati <i>One hole arranged for three tap holes</i>		Vaso installazione a filo, scarico parete/pavimento <i>WC back to wall installation, floor/wall drain.</i>
	Predisposto tre fori diaframmati <i>Arranged for three tap holes</i>		Bidet installazione a filo <i>Bidet back to wall installation</i>
	Predisposto per rubinetteria su piano d'appoggio <i>Suitable for taps mounted on counter top</i>		Prodotto salva-spazio <i>Space-saving product</i>
	Predisposto per rubinetteria a muro <i>Suitable for wall-mounted taps</i>		VASOMULTI®
	Lavabo per installazione sospesa <i>Basin suitable for wall-hung installation</i>		BIDETMULTI®
	Lavabo per installazione incasso <i>Basin suitable for recessed installation</i>		Sanitari a terra completi di FISSAGGIHOST® <i>Floor-mounted sanitarries with FISSAGGIHOST®</i>
	Lavabo per installazione sottopiano <i>Basin suitable for under-counter installation</i>		Scarico ottimizzato a 4,5/3 litri <i>Drain 4,5/3 lt</i>
	Lavabo per installazione da appoggio <i>Basin suitable for sit-on installation</i>		Cassetta di scarico con guscio anticondensa <i>Drain cistern with anti-condensation case</i>
	Lavabo per installazione semi-incasso <i>Basin suitable for semi-recessed installation</i>		Sifone incluso <i>Siphon included</i>
	Lavabo per installazione su mobile <i>Basin suitable for installation on piece of furniture</i>		Fissaggi inclusi <i>Fixing kit included</i>
	Con foro troppo pieno <i>With overflow hole</i>		Fissaggi non inclusi <i>Fixing kit not included</i>
	Senza foro troppo pieno <i>Without overflow hole</i>		Codice composto da piu' articoli <i>Code composed by several items</i>



# DesignTime.

## **Ceramica Globo spa**

Loc. La Chiusa . 01030 . Castel Sant'Elia - (VT) . Italy  
Tel+39 0761 516568 . Fax+39 0761 515168

## **Showroom** . Corso Monforte, 15 . 20122 Milano

Tel+39 02 36521510 .

Mail: monforte15@ceramicaglobo.com

## **Globo Concept Shop** . Shop C, Ground Floor

336-342 Lockhart Road . Wanchai, Hong Kong

Tel. +(852) 2988 1904 . Fax +(852) 2988 1147

**info@ceramicaglobo.com**

## **follow us**



**ADIMEMBER**



[www.ceramicaglobo.com](http://www.ceramicaglobo.com)



## **Concept and graphics**

Benaglia+Orefice Studio Associato

## **Photo**

Zerotremedia

## **Print**

Telligraf

2014 - all rights reserved ©



[www.ceramicaglobo.com](http://www.ceramicaglobo.com)