



CATALOGUE - PRICE LIST 1.0



 **GIULINI** **G**<sup>®</sup>  
R U B I N E T T E R I A

# INDICE

MODERNO



MyRing

**p. 24**



Surf

**p. 48**



Pablolux

**p. 70**



Futuro

**p. 96**



Giò Crystal  
Giò

**p. 120**



G3

**p. 134**

CLASSICO



Praga  
Praga Crystal

**p. 164**



PragaMix  
PragaMix Crystal

**p. 184**



Persia Crystal  
Persia

**p. 200**



Odessa Crystal

**p. 208**



Harmony  
Harmony Crystal

**p. 216**



Symphony

**p. 230**

CONTEMPORARY



Lady

**p. 314**



Linea

**p. 320**



Corner

**p. 326**



KellyGreen

**p. 330**



Kelly  
Mery

**p. 334**



Roma

**p. 340**

WELLNESS



Composizioni  
Docce  
Termostatici  
Shut Off  
Schema Incassi - Deviatori

**p. 374**

ACCESSORI BAGNO



Erica  
Moderna  
Ibisco Crystal - Ibisco Ceramica  
Ibisco  
Lilium  
Specchi

**p. 438**

ARTICOLI VARI



Vari  
Comunità

**p. 474**



G4

**p. 142**



PLP

**p. 150**



Quack

**p. 154**



Elica

**p. 158**



Hermitage  
Hermitage Crystal

**p. 244**



Kensington

**p. 250**



Parigi

**p. 262**



Londra

**p. 278**



G5

**p. 294**



Lotus  
Vienna

**p. 302**



Melody  
Epoca

**p. 346**



Infinito  
Spazio

**p. 352**



Goldenlux  
GoldenStar

**p. 358**



Giada  
Giadalux

**p. 362**



700

**p. 366**



Moderno  
Classico  
Contemporary

**p. 492**



Sanitari d'Arredo  
Scaldasalviette

**p. 518**





.....

Da oltre 50 Anni la **Giulini G. Rubinetteria** è Qualità, Creatività, Innovazione e Passione. Questi i principi con cui da sempre ha saputo interpretare un mercato in continua evoluzione. Un costante impegno che ha portato l'azienda a diventare una realtà industriale di livello internazionale.

*For over 50 years **Giulini G. Rubinetteria** has meant Quality, Creativity, Innovation and Passion. These are the principles which have always been applied to reinterpret the ever-changing market. A continuous commitment that has led the company to an international industrial level.*

.....

dal 1966



I Fondatori  
The Founders



Esce la storica serie Lotus  
Creation of the historic collection Lotus



Esce la serie che diventerà il simbolo di Giulini: Kelly  
Come-out of the collection that will turn out to be Giulini's symbol: Kelly

TIMELINE

1975

1993

1966

1985

Giovanni Giulini e Graziella Godio fondano la Rubinetteria Giulini

Giovanni Giulini and Graziella Godio started Rubinetteria Giulini



Entra in azienda Piero Giulini

Piero Giulini joins the company







Nasce il programma esclusivo Crystal  
*Development of the exclusive Crystal Programme*



Esce Surf per restare sull'onda del mercato. Con il passaggio generazionale l'azienda si trasforma in s.r.l.  
*Surf comes out to balance on the market wave. The generational handover leads to the change of the company name.*

2007

2015

1997

2011

2016

Entra in azienda Daniele Giulini  
*Daniele Giulini joins the company*



Esce la serie innovativa PLP  
*Invention of the innovative PLP collection*



50 anni di storia.  
*MyRing collection: un segno di tendenza*

50 Years of Giulini.  
*MyRing collection: the mark of a trend*

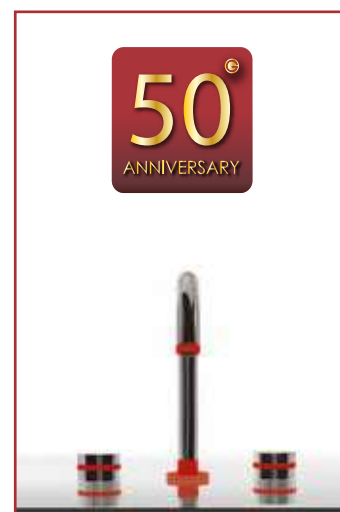

# DOVE SIAMO / WHERE WE ARE

---

La Giulini G. Rubinetteria nasce a Pogno, in provincia di Novara a pochi chilometri da Milano, vicino al lago d'Orta nel più importante bacino nazionale ed internazionale dedicato alla produzione della rubinetteria.

*Giulini G. Rubinetteria was established in Pogno, in the Province of Novara a few kilometers from Milan, near Lake Orta, in the most important national and international manufacturing district of taps and fittings.*

---





*MADE IN ITALY / MADE IN ITALY*

---





ISTITUTO PER LA TUTELA DEI PRODUTTORI ITALIANI

*Made in Italy 100% Certificate*

REGISTRAZIONE N° IT01.IT/912.123.M

SI ATTESTA CHE  
This is to certify that

**GIULINI G.**

E' UN MARCHIO CERTIFICATO AVENTE I REQUISITI DEL SISTEMA IT01 - 100% QUALITA' ORIGINALE ITALIANA  
acts according to system IT01 - 100% Original Italian Quality

QUESTA CERTIFICAZIONE E' INOLTRE VALIDA PER IL SEGUENTE CAMPO APPLICATIVO:  
This certificate is also valid for the following product or service range:

RUBINETTI BAGNO E CUCINA  
Bathroom and Kitchens Taps

DITTA PRODUTTRICE E DISTRIBUZIONE  
Manufacturer and distribution Company

RUBINETTERIA GIULINI GIOVANNI SNC  
Via Salvo D' Acquisto, 22 - 28076 Pogno (NO)

SISTEMA IT01 - 100% QUALITA' ORIGINALE ITALIANA  
The certified Company:

QUESTI PRODOTTI SONO:  
These products are:

A - FABBRICATI INTERAMENTE IN ITALIA Entirely Made in Italy	D - REALIZZATI CON DISEGNI E PROGETTAZIONE ESCLUSIVI DELL'AZIENDA Made according to the Company's exclusive styles and designs
B - REALIZZATI CON SEMILAVORATI ITALIANI Made with Italian components	E - COSTRUITI ADOTTANDO LE LAVORAZIONI ARTIGIANALI, TRADIZIONALI TIPICHE ITALIANE Made according to the typical Italian craftsmanship and tradition
C - COSTRUITI CON MATERIALI NATURALI DI QUALITA' E DI PRIMA SCELTA Made with natural top quality materials	

Organismo Asseverante:  
Supporting unit:  
PROMINDUSTRIA SPA



Stamp / Trade Mark  
Timbro dell'Istituto

MILANO, 31/01/2014

LA VALIDITA' DEL PRESENTE CERTIFICATO MADE IN ITALY E' SUBORDINATA AL RIESAME COMPLETO DEL SISTEMA CON PERIODICITA' ANNUALE  
The validity of this Made in Italy Certificate is subjected to a periodical complete annual inspection



WALTER MARTINI  
President

NAZZARENO VITA  
Director



L'azienda si contraddistingue per la realizzazione di prodotti di qualità e dal design innovativo dove il "made in Italy" è fatto di sostanza e non di propaganda. Tutto ciò è merito di una profonda conoscenza delle problematiche tecniche e di un continuo confronto con la propria clientela, nell'intento di soddisfare le richieste dei consumatori più attenti ed esigenti. Un brand che ha saputo offrire prodotti sempre più tecnologici e in linea con le nuove tendenze.

*Giulini G. Rubinetteria company stands out for its quality products and innovative design, where "Made in Italy" is real and not just mere propaganda. This is the well-deserved result of a deep knowledge in technical issues and of a never-ending dedication to the most demanding customers. A brand that has been able to offer always more technological products, in line with the new trends.*



This is to certify that the

**Quality Management System**

**RUBINETTERIA GIULINI GIOVANNI S.R.L.**

VIA - ALVIO D'ACQUISTO, 22 - 28076 POGNO (NO) - ITALY

Has been assessed by Certification Europe and deemed to comply with the requirements of

**ISO 9001:2008**

This certificate is valid for the activities specified below:

**SVILUPPO E COSTRUZIONE DI RUBINETTERIA SANITARIA IN OTTONE ED ACCIAIO INOSSIDABILE**

Certification of Registration remains the property of Certification Europe Ltd. The validity of this Certificate is maintained on the condition that the Management System is reviewed to support a continuing improvement programme and continues to satisfactorily meet the requirements of the standard. To verify this certificate validity please contact us at info@certificationeurope.com

Date of initial certification: 1 May 1998      This certificate is valid until: 31 September 2018

Chief Executive: Michael Shepley      Chairman: Patrick A. White

Signatures: 

ISO 9001:2008      IAF



# LO STILE / OUR STYLE

---

Il mondo di Giulini G. si esprime a 360 gradicon più di 30 collezioni nelle aree tematiche: Bagno, Wellness e Cucina suddivise in 3 proposte stilistiche: **Moderno, Classico e Contemporary.**

## MODERNO

Raffinatezza, essenzialità e semplicità nei tratti per le collezioni in stile **Moderno**, grazie a tagli puliti, a linee definite e a un look sofisticato che conferisce all'ambiente bagno fascino e personalità.

## CLASSICO

Il **Classico** di Giulini riprende elementi intramontabili per uno stile senza tempo dal sapore romantico con una particolare attenzione ai dettagli dando un tocco di eleganza e prestigio alla sala bagno.

---

*Giulini world finds its expression in over 30 collections and 3 thematic areas: Bathroom, Wellness and Kitchen, which are in turn available in **Modern, Classic or Contemporary style.***

## MODERN

*Refinement, essentiality and simplicity are the distinguishing features of the collections in **Modern style.** Clean design, defined lines and a sophisticated look give a touch of charme and character to the bathroom.*

## CLASSIC

*The **Classic** by Giulini reinterprets everlasting elements by creating a prestigious and elegant bathroom, which becomes the expression of a timeless style made of romantic nuances and a unique attention to details.*





---

Crystals from Swarovski®







Moderno e Classico propongono le varianti **Crystal**, impreziosite da Cristalli Swarovski perfettamente incastonati. Lo scintillio delle pietre s'integra perfettamente con le finiture della rubinetteria.

**CONTEMPORARY**

Lo stile **Contemporary** è l'offerta commerciale per un mercato sempre più esigente con un'attenzione particolare al mondo contract, dove l'aspetto estetico e formale dal design accattivante si unisce a quello funzionale.

*Modern and Classic collections are also enhanced by the use of Swarovski Elements: the sparkle of crystals and taps' finishes perfectly merge into the creation of the **Crystal Programme**.*

**CONTEMPORARY**

***Contemporary** style is meant to be the proposal for an increasingly demanding market, paying a specific attention to Contract world, where design meets functionality.*

# REFERENTI / REFERRERS

---



QBIC HOTEL  
Amsterdam



AROSEA LIFE BALANCE HOTEL  
Merano



BEST WESTERN TIGULLIO HOTEL  
Rapallo



VILLA PALMA  
Vicenza



HOTEL PERALBA  
Saronno



QBIC HOTEL  
Londra



AMAN RESORT  
Giordania



HOTEL SANTACHIARA  
Venezia



GRAND HOTEL VILLA SERBELLONI  
Bellagio



RISTORANTE QUATTROPASSI  
Londra



VILLA PRIVATA  
Zurigo



RESORT  
Cancun

INTERPRETAZIONE DEI CODICI - CODE EXPLANATION  
 INTERPRETATION DES CODES - ERKLÄRUNG DER ARTIKELNUMMER  
 INTERPRETACIÓN DE LOS CÓDIGOS - РАСШИФРОВКА СИМВОЛОВ

**6533A**

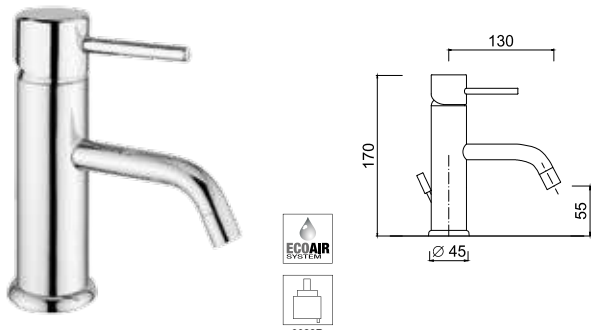

**Monocomando lavabo, scarico 1"1/4 (con flessibile).**  
*Wash-basin single-lever mixer, luxury 1"1/4 pop-up waste (with flexible).*  
*Mitigeur lavabo avec vidage 1"1/4 (avec flexible).*  
*Einhand-Waschtischbatterie mit Ablaufgarnitur 1"1/4 (mit flexiblen Anschlussschläuchen).*  
*Monomando lavabo tapón accionado por varilla 1"1/4 lujo (con flexible).*  
*Однорычажный смеситель для раковины, донный клапан 1"1/4 (гибкая подводка).*

Articolo	Note	CROMO	BO - NO - NKO	BR	O
<b>6533A</b>		166,00	224,00		
<b>6533/SC</b>	SC	153,00	211,00		
<b>1714-30</b>	mm.300	335,00	●	364,00	420,00

Lavabo - Wash-basin

**IT** Al fine di redigere ordini formalmente corretti nella formulazione dei codici, segue una descrizione dettagliata su come interpretare i dati forniti nel presente listino. Un ordine corretto è composto da:

1° Il codice articolo che si trova di fianco alla foto (Ad esempio: il "Monocomando lavabo" della serie FUTURO corrisponde al Cod. 6533A).

2° Il codice della finitura desiderata, che si trova nella legenda (Ad esempio: la finitura "Nero Opaco" corrisponde al codice NO. Quindi, volendo ordinare il "Monocomando lavabo" della serie FUTURO in finitura Nero Opaco, si formulerà il seguente codice: Cod. 6533ANO).

**EN** With the aim of placing formally correct orders with proper codes, a detailed description of how to interpret the information supplied in this pricelist is set below. A correct order consists of:

1° The article code indicated beside the picture (for example: "Wash-basin single-lever mixer" of FUTURO series corresponds to Cod. 6533A).

2° The code of the desired finishing placed in the legend (for example: finishing "Matt Black" corresponds to code NO. Thus, if you want to order "Wash-basin single-lever mixer" of FUTURO series with Matt Black finishing, the correct code to indicate is: Cod. 6533ANO).

**FR** Dans le but de réaliser des commandes formulées correctement concernant l'interprétation des codes, une description détaillée des données incluses dans ce tarif est indiquée ci dessous. Une commande correcte comprend:

1° Le code produit qui se trouve à coté de la photo (Exemple: "Mitigeur lavabo" de la série FUTURO correspond au Code 6533A).

2° Le code de la finition qui se trouve dans la légende (Exemple: finition "Noir Mat" correspond au code NO. Pourtant, si on désire commander le "Mitigeur lavabo" de la série FUTURO avec finition Noir Mat, on devra indiquer le code suivant: 6533ANO).

**DE** Damit die Artikelnummer in die Bestellung korrekt eingeschrieben werden, folgt hierunter eine Erklärung von den in der Preisliste angegebenen Daten. Eine korrekte Bestellung enthält:

1° Die Artikelnummer neben den Fotos (z.B. die Artikelnummer für den "Einhebel-Waschtischmischer" der FUTURO Serie ist 6533A)

2° Der Code für die Farbe - siehe Legende (z.B. der Code für Schwarz-Matt lautet NO. Daher, um den Artikel "Einhebel-Waschtischmischer" Serie FUTURO mit der Oberfläche Schwarz-Matt zu bestellen, muss man die Artikelnummer 6533ANO einschreiben).

**ES** Con el objetivo de realizar pedidos formalmente correctos en la formulación de los códigos, sigue una descripción detallada de como interpretar los datos suministrados en la presente lista. Un pedido correcto se compone de:

1° El número de artículo que se encuentra al lado de la foto (por ejemplo: "Monomando lavabo" de la serie FUTURO corresponde al Cód. 6533A).

2° El código del acabado deseado, que se encuentra en la leyenda (por ejemplo: acabado "Negro Mate" corresponde al código NO. Entonces, si se quiere pedir el "Monomando lavabo" de la serie FUTURO con acabado Negro Mate, se formulará el siguiente código: Cód. 6533ANO).

**RU** С целью помочь Вам правильно сформулировать заказ, ниже приводим подробную информацию о видах кодировки в данном каталоге и о том, как это сделать. Правильный порядок кодировки составляется следующим образом:

1. Код, находящийся возле изображения (Например: "Смеситель для умывальника" серии FUTURO соответствует коду 6533A)

2. Код отделки, находящийся в разделе спецификации знаков (Например: отделка "Черный матовый" соответствует коду NO. Если Вы желаете заказать Смеситель для умывальника серии FUTURO в отделке "Черный матовый", Вам необходимо указать в заказе следующий код: 6533ANO)

# LEGENDA SIMBOLI - EXPLANATION OF SYMBOLS

## EXPLICATION DES SYMBOLES - ERKLÄRUNG DER SYMBOLE

### EXPLICACIÓN DE LOS SÍMBOLOS - РАСШИФРОВКА СИМВОЛОВ

	Cartuccia ceramica Ceramic cartridge Cartouche céramique Keramikkartusche Cartucho cerámico Керамический картридж		Cromoterapia Chromotherapy Chromothérapie Farbtherapie Farbtherapie Cromoterapia Хромотерапия		Doccia 3 getti 3-jets handshower Douchette 3 jets 3 jets Handbrause Ducha 3 jets Трёхструйный душ
	Cartuccia progressiva Progressive cartridge Cartouche progressive Progressive Kartusche Cartucho progresivo Прогрессивный картридж		Apertura frontale Front opening Ouverture sur le devant Öffnung vorn Abertura delantera Открытие вперед		Doccetta estraibile Pull-out shower Douchette extractible Ausziehauslauf Caño extraíble Выдвижной душ
	Cartuccia Joystick Joystick cartridge Cartouche Joystick Joystick-Kartusche Cartucho Joystick Джойстик картридж		Soffione tondo D.200 mm Round showerhead Ø 200 mm Pomme de douche ronde, Ø mm.200 Wandarm, Antikalk System Ø 200 mm Rociador rondo Ø 200 mm Круглая душевая лейка Ø 200		Orientabile Swivelling Pivotant Schwenkbar Giratorio Поворотный
	Vitone dischi ceramici, rotazione 90° Ceramic discs headwork, 90° rotation Têtes de clapet en céramique, rotation 90° Keramischen Dichtungen, 90° Drehung Montura cierre cerámico, rotación 90° Керамический картридж поворот на 90°		Soffione tondo D.250 mm Round showerhead Ø 250 mm Pomme de douche ronde, Ø mm.250 Wandarm, Antikalk System Ø 250 mm Rociador rondo Ø 250 mm Круглая душевая лейка Ø 250		Telescopico Extendible Extensible Höhenverstellbar Telescópico Телескопическая штанга
	Vitone tradizionale Non-ceramic standard headwork Têtes de clapet traditionnelle Nicht-keramische Standardkopfarbeit Montura cierre tradicional Традиционный картридж		Soffione quadrato 200x200 mm Square showerhead 200x200 mm Pomme de douche carrée, 200x200 mm Eckigem Wandarm, 200x200 mm Rociador cuadrado 200x200 mm Квадратная душевая лейка 200x200 mm		Scarrevole Sliding Coulissant Serschiebbar Deslizante Передвижной
	Termostatico Thermostatic Thermostatique Thermostatisch Termostático Термостатический		Soffione quadrato 250x250 mm Square showerhead 250x250 mm Pomme de douche carrée, 250x250 mm Eckigem Wandarm, 250x250 mm Rociador cuadrado 250x250 mm Квадратная душевая лейка 250x250 mm		Abbatibile Folding Rabattable Klappbar Abatible Складной
	Deviatore 3 vie - 1 entrata 2 uscite 3-way diverter - 1 inlet 2 outlets Inverseur 3 voies - 1 entrée 2 sorties 3-Wege-Umstellung - 1 Eingang 2 Ausgänge Desviador a 3 vías - 1 entrada 2 salidas Переходник на 3 канала-1 вход 2 выхода		Soffione quadrato 300x300 mm Square showerhead 300x300 mm Pomme de douche carrée, 300x300 mm Eckigem Wandarm, 300x300 mm Rociador cuadrado 300x300 mm Квадратная душевая лейка 300x300 mm		Aeratore orientabile Swiveling aerator Aérateur pivotant Schwenkbar Luftsprudler Aireador giratorio Поворотный аэратор
	Deviatore 4 vie-2 entrate 2 uscite 4-way diverter -2 inlets and 2 outlets Inverseur 4 voies-2 entrées et 2 sorties 4-Wege-Umstellung, 2 Eingänge und 2 Ausgänge Desviador a 4 vías, 2 entradas y 2 salidas Переходник на 4 канала-2 входа 2 выхода		Soffione quadrato 500x500 mm Square showerhead 500x500 mm Pomme de douche carrée 500x500 mm Eckigem Duschkopf, 500x500 mm Rociador cuadrado 500x500 mm Квадратная душевая лейка 500x500 mm		Getto libero / getto a cascata Waterfall jet Jet à cascade Wasserfallstrahl Chorro cascada Свободный излив/каскадный излив
	Deviatore 4 vie-1 entrate 3 uscite 4-way diverter -1 inlet and 3 outlets Inverseur 4 voies-1 entrée et 3 sorties 4-Wege-Umstellung, 1 Eingänge und 3 Ausgänge Desviador a 4 vías, 1 entradas y 3 salidas Переходник на 4 канала-1 вход 3 выхода		Soffione RETRO® Ø 200 mm RETRO® showerhead, Ø mm.200 Pomme de douche RETRO®, Ø 200 mm RETRO® Wandarm Ø 200 mm Rociador rondo RETRO® Ø 200 mm Душевая лейка RETRO® Ø 200 мм		Aeratore WATERSAVING, 5 Lt min WATERSAVING aerator, 5 Lt per min Aérateur WATERSAVING, 5 Lt par min WATERSAVING Luftsprudler, 5 Lt per Min WATERSAVING aireador, 5 Lt por min Аэратор WATERSAVING, 5 литров в минуту
	Deviatore 5 vie-2 entrate 3 uscite 5-way diverter -2 inlets and 3 outlets Inverseur 5 voies-2 entrées et 3 sorties 5-Wege-Umstellung, 2 Eingänge und 3 Ausgänge Desviador a 5 vías, 2 entradas y 3 salidas Переходник на 5 каналов-2 входа 3 выхода		2 ingressi 2 water inlets 2 entrées d'eau 2 Wassereingänge 2 entradas de agua 2 входа		Aeratore WATERSAVING, 12 Lt min WATERSAVING aerator, 12 Lt per min Aérateur WATERSAVING, 12 Lt par min WATERSAVING Luftsprudler, 12 Lt per Min WATERSAVING aireador, 12 Lt por min Аэратор WATERSAVING, 12 литров в минуту
	Deviatore 5 vie-1 entrate 4 uscite 5-way diverter -1 inlet and 4 outlets Inverseur 5 voies-1 entrée et 4 sorties 5-Wege-Umstellung, 1 Eingänge und 4 Ausgänge Desviador a 5 vías, 1 entradas y 4 salidas Переходник на 5 каналов-1 вход 4 выхода		3 ingressi 3 water inlets 3 entrées d'eau 3 Wassereingänge 3 entradas de agua 3 входа		Scarico per lavabo Up&Down 1"1/4 Basin drain 1"1/4 Up&Down Vidage lavabo Up&Down 1"1/4 Ablaufgarnitur Up&Down 1"1/4 Desagüe automatico Up&Down 1"1/4 Слив для умывальника Up&Down 1"1/4
	Box incasso Bull-in box Boîte encastrée Einbau-Box Caja empotrada Встроенная часть		Sistema anticalcare Anti-scale system Système anti-calcaire Antikalksystem Sistema antical Система защиты от известняка		Senza scarico Without pop-up waste Sans vidage Ohne Ablaufgarnitur Sin desagüe Без донного клапана
	Connessioni interne Internal connections Connexions internes Interne Anschlüsse Conexiones internas Внутренние соединения		Doccia 5 getti 5-jets handshower Douchette 5 jets 5 jets Handbrause Ducha 5 jets Пятиструйный душ		Ecoair Ecoair Ecoair Ecoair Ecoair Ecoair
					Inox Inox Inox Inox Inox

Illustrazioni, descrizioni e caratteristiche tecniche non sono impegnative, in quanto l'Azienda si riserva la facoltà di apportare migliorie alla produzione in qualunque momento e senza preavviso.

Illustrations, descriptions and technical characteristics are not binding, since the Company reserves the right to improve the production at any time and without prior notice.

















Illustrations, descriptions et caractéristiques techniques ne sont pas contraignantes. L'usine se réserve le droit d'améliorer la production à tout moment et sans préavis.

Abbildungen, Beschreibungen und technische Merkmale sind nicht verbindlich. Die Firma behält sich das Recht vor, den Produkten jederzeit und unangekündigt Verbesserungen vorzunehmen.

Ilustraciones, descripciones y características técnicas no son vinculantes. La empresa se reserva el derecho de introducir mejoras en la producción en cualquier momento y sin previo aviso.

Иллюстрации, описания и технические характеристики не являются обязательными, поскольку Компания оставляет за собой право на улучшение продукции в любой момент времени и без предупреждения.

# FINITURE - FINISHES - COULEURS FARBEN - COLORES - ОТДЕЛКИ

 <p><b>CROMO</b> CHROME-PLATED - CHROME* - CHROM CROMADO - ХРОМ</p>				
<p><b>BO</b></p>  <p><b>BIANCO OPACO</b> MATT WHITE - BLANC MAT - EISS-MATT BLANCO MATE - МАТОВЫЙ БЕЛЫЙ</p>	<p><b>NO</b></p>  <p><b>NERO OPACO</b> MATT BLACK - NOIR MAT - SCHWARZ-MATT NEGRO MATE - МАТОВЫЙ ЧЁРНЫЙ</p>	<p><b>NKO</b></p>  <p><b>NIKEL OPACO</b> MATT NICKEL - NICKEL MAT - NICKEL MATT NIKEL OPACO - МАТОВЫЙ НИКЕЛЬ</p>	<p><b>BEO</b></p>  <p><b>BEIGE ORO</b> BEIGE GOLD - BEIGE OR - BEIGE GOLD BEIGE ORO - БЕЖЕВЫЙ ЗОЛОТО</p>	
<p><b>AR</b></p>  <p><b>ARGENTO ANTICO</b> Old Silver - Acier - Alt-Silber Plata Vieja - Серебро Под Старину</p>	<p><b>BR</b></p>  <p><b>BRONZO</b> Bronze - Bronze - Bronze/ Bronze - Бронза</p>		<p><b>VR</b></p>  <p><b>VECCHIO RAME</b> Old Copper - Cuivre Ancien - Alt-Kupfer Cobre Antiguo - Медь Под Старину</p>	
<p><b>O</b></p>  <p><b>ORO</b> Gold - Or - Gold - Oro - Золото</p>		<p><b>CR</b></p>  <p><b>CROMO ORO</b> Chrome Gold - Chromé Or - Chrom Gold Cromado Oro - Хром Золото</p>		
<p><b>NLC</b></p>  <p><b>NERO LUCIDO CROMO</b> Gloss Black Chrome - Noir Brillant Chrome - Schwarz Glänzend Chrom - Negro Brillo Cromado - Глянцевый Чёрный Хром</p>	<p><b>NLO</b></p>  <p><b>NERO LUCIDO ORO</b> Gloss Black Gold - Noir Brillant Or - Schwarz Glänzend Gold - Negro Brillo Oro Глянцевый Чёрный Золото</p>	<p><b>BLC</b></p>  <p><b>BIANCO LUCIDO CROMO</b> Bianco Lucido Cromo - Gloss White Chrome Blanc Brillant Chrome - Eiß Glänzend Chrom Blanco Brillo Cromado - Глянцевый Белый Хром</p>	<p><b>BLO</b></p>  <p><b>BIANCO LUCIDO ORO</b> Gloss White / Gold - Blanc Brillant / Or Weiß Glänzend / Gold - Blanco Brillo / Oro ГЛЯНЦЕВЫЙ БЕЛЫЙ / ЗОЛОТО</p>	
<p><b>SF</b></p>  <p><b>SFUMATO</b> Terre De France - Terre De France - Terre De France Tierra De Francia - Терракота</p>		<p><b>BA</b></p>  <p><b>BEIGE AVENA</b> Oat Beige - Beige Avoine - Haferbeige Amarillento Avena - овсяно-бежевый</p>		<p><b>GA</b></p>  <p><b>GRIGIO AMBRA</b> Ambergris - Gris Ambre - Grau Bernstein Ambar gris - серый янтарь</p>

**PV:** Cromato parti verniciate / Chrome-plated with varnished parts / Chromé avec parties peintes  
Chrom mit lackierten Teilen / Cromado con partes barnizadas / Хромированный с лакированными частями

**C:** Colorato parti cromo / Coloured with chrome-plated parts / Couleur avec parties chromees  
Farbig mit chromteilen / Pintado con partes cromadas/ Цветной, отдельные части в хроме

**CO:** Colorato parti oro / Coloured golden parts / Couleurs parties or  
Standard farbe mit goldteilen / Pintado partes oro / В цвете, отдельные части в золоте

**LV:** Cromato leva verniciata / Chrome-plated with varnished lever / Chromé avec levier peint  
Chrom mit lackierter Hebel / Cromado con palanca barnizada / Хромированный с лакированной ручкой

**\*** : Alcune parti potrebbero differenziarsi dallo standard / Some parts might differ from standard  
Certaines parties pourraient se différencier du standard / Einige Teile könnten vom Standard abweichen  
Algunas partes podrían variar del estándar / Некоторые части могут отличаться от стандарта





MODERNO

# MyRing

design: Gianluca Paludi





MyRing













**MR0112A**

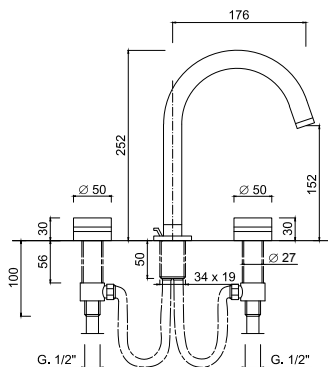

**Batteria lavabo 3 fori, bocca girevole, scarico 1"1/4**  
3-hole wash-basin set, swivel spout, 1"1/4 pop-up waste.  
Mélangeur lavabo à trois trous, bec mobile, vidage automatique 1"1/4.  
Waschtisch-Dreilochbatterie, Schwenkauslauf, Ablaufgarnitur 1"1/4.  
Batería lavabo con 3 agujeros, caño giratorio, tapón accionado por varilla 1"1/4.  
Комплект для раковины на 3 отверстия, поворотный излив, донный клапан 1"1/4

Articolo	Note	CROMO	PV	C	BEO
MR0112A		366,00	402,00	439,00	658,00

**MR0112/U**

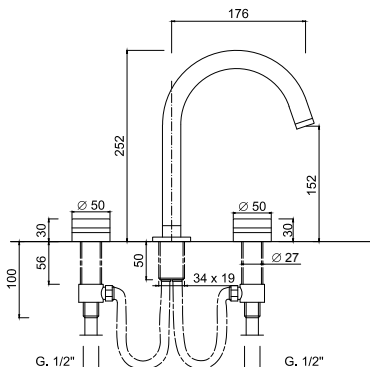
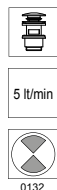

**Batteria lavabo 3 fori, bocca girevole, scarico Up&Down**  
3-hole wash-basin set, swivel spout, Up&Down pop up waste.  
Mélangeur lavabo à trois trous, bec mobile, vidage Up&Down.  
Waschtisch-Dreilochbatterie, Schwenkauslauf, Ablaufgarnitur Up&Down.  
Batería lavabo con 3 agujeros, caño giratorio, Desague Up&Down.  
Комплект для раковины на 3 отверстия, поворотный излив, донный клапан Up&Down

Articolo	Note	CROMO	PV	C	BEO
MR0112/U		387,00	426,00	464,00	696,00

**MR0157A**

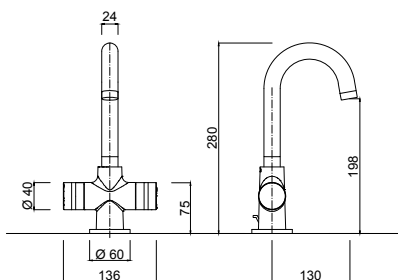

**Monoforo lavabo, bocca girevole, scarico 1"1/4 (con flessibile)**  
Wash-basin unit, swivel spout, 1"1/4 pop-up waste (with flexible).  
Mélangeur monotrou lavabo, bec mobile, vidage automatique 1"1/4 (avec flex.)  
Waschtisch-Einlochbatterie, Schwenkauslauf, Ablaufgarnitur 1"1/4 (mit flexiblen Anschlussschläuchen).  
Monobloque lavabo, caño giratorio, tapón accionado por varilla 1"1/4 (con flexible).  
Смеситель для раковины, поворотный излив, донный клапан 1"1/4 (гибкая подводка).

Articolo	Note	CROMO	PV	C	BEO
MR0157A		333,00	366,00	399,00	599,00

**MR0030/U**

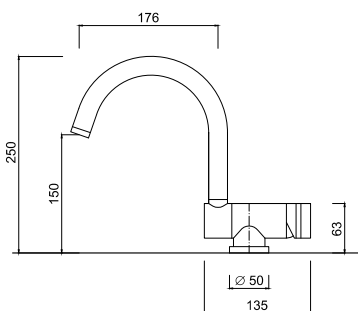
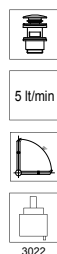

**Monocomando lavabo abbattibile, bocca girevole, scarico Up&Down (con flessibile)**  
Reclinable wash-basin mixer, swivel spout, Up&Down pop up waste (with flexible).  
Mitigeur lavabo inclinable, bec mobile, vidage Up&Down (avec flex.).  
Senkbarer Waschtisch-Einhebelmischer, Schwenkauslauf, Ablaufgarnitur Up&Down (mit flexiblen Anschlussschläuchen).  
Monomando lavabo reclinable, caño giratorio, Desague Up&Down (con flex.)  
Наклонный смеситель для раковины, поворотный излив, донный клапан Up&Down (гибкая подводка).

Articolo	Note	CROMO	PV	C	BEO
MR0030/U		293,00	322,00	351,00	527,00

**MR0085A**

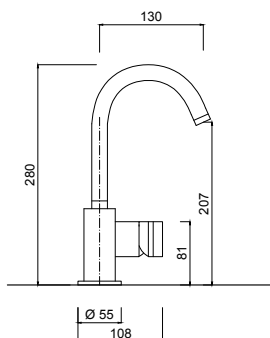

**Monocomando lavabo, bocca girevole, scarico 1"1/4 (con flessibile)**  
Wash-basin mixer, swivel spout, 1"1/4 pop-up waste (with flexible).  
Mitigeur lavabo, bec mobile, vidage automatique 1"1/4 (avec flex.).  
Waschtisch-Einhebelmischer, Schwenkauslauf, 1"1/4 Zugknopf Ablaufgarnitur Luxus (mit flexiblen Anschlussschläuchen).  
Monomando lavabo, caño giratorio, tapón accionado por varilla 1"1/4 (con flex.)  
Смеситель для раковины, поворотный излив, донный клапан 1"1/4 (гибкая подводка).

Articolo	Note	CROMO	PV	C	BEO
MR0085A		261,00	287,00	313,00	469,00

**MR0085HA**

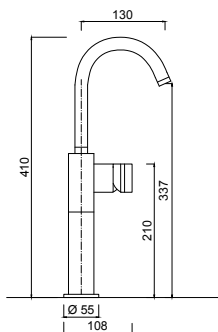

**Monocomando lavabo con prolunga, bocca girevole, scarico 1"1/4 (con flessibile)**

Wash-basin mixer with high and swivel spout, 1"1/4 pop-up waste (with flexible).

Mitigeur lavabo avec bec haut et mobile, vidage automatique 1"1/4 (avec flex.).

Waschtisch-Einhebelmischer mit hochgesetztem Schwenkbarem, 1"1/4 Zugknopfablaufgarnitur (mit flexiblen Anschlussschläuchen).

Monomando lavabo con caño alto y giratorio, tapón accionado por varilla 1"1/4 (con flex.).

Смеситель для раковины с высоким и поворотным изливом, донный клапан 1"1/4 (гибкая подводка).

Articolo	Note	CROMO	PV	C	BEO
<b>MR0085HA</b>		355,00	390,00	426,00	639,00

**MR0040/SC**

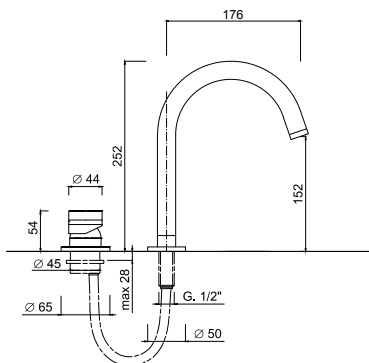

**Monocomando lavabo 2 fori, bocca girevole (con flessibile)**

2-hole wash-basin mixer, swivel spout (with flexible).

Mitigeur lavabo à deux trous, bec mobile (avec flex.).

Waschtisch- Zweilochbatterie, Schwenkauslauf (mit flexiblen Anschlussschläuchen).

Monomando lavabo con 2 agujeros, caño giratorio (con flex.).

Смеситель для раковины на 2 отверстия (гибкая подводка).

Articolo	Note	CROMO	PV	C	BEO
<b>MR0040/SC</b>		242,00	266,00	290,00	435,00

**MR0020**

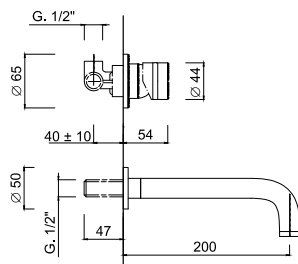
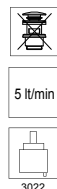

**Monocomando lavabo a muro, senza scarico**

Wall mounted basin set, without pop-up waste.

Mélangeur lavabo mural, sans vidage.

Einhebel-Waschtischmischer Wandmontage, ohne Ablaufgarnitur.

Lavabo de pared, sin desague.

Комплект настенного монтажа для раковины, без донного клапана.

Articolo	Note	CROMO	PV	C	BEO
<b>MR0020</b>		226,00	246,00	266,00	406,00

**MR0123**

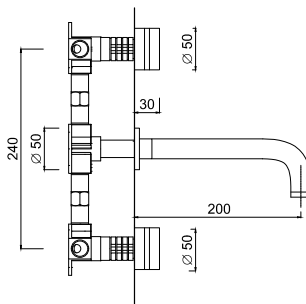

**Lavabo 3 fori a muro (con connessioni)**

3-hole wall mounted basin set (with connections).

Mélangeur lavabo mural à 3 trous (avec les contacteurs).

Waschtisch-Dreilochbatterie Wandmontage (mit Verbindungen).

Lavabo de pared con 3 agujeros (con conexiones).

Комплект настенного монтажа для раковины на 3 отверстия (с соединениями).

Articolo	Note	CROMO	PV	C	BEO
<b>MR0123</b>		477,00	524,00	572,00	858,00

**MR0090**

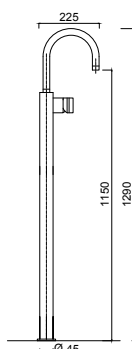
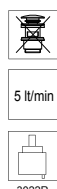

**Monocomando lavabo a pavimento, bocca girevole**

Wash-basin single-lever mixer with floor pillar leg, swivel spout.

Mitigeur lavabo avec colonnette alimentation par le sol, bec mobile.

Waschtisch-Einhebelmischer mit Standfuss Schlauch, Schwenkauslauf.

Monomando lavabo con colonna a pavimento, caño giratorio.

Однорычажный смеситель для раковины с напольной колонной, поворотный излив.

Articolo	Note	CROMO	PV	C	BEO
<b>MR0090</b>		999,00	1.098,00	1.198,00	•



**MR0015WB**

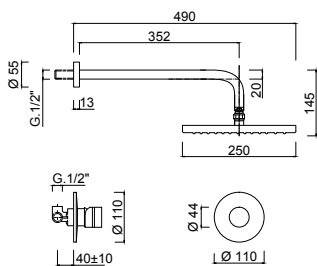
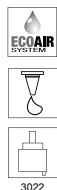

**Set doccia incasso monocomando, soffione ottone**  
Shower built-in single-lever mixer, brass shower head.  
Mitigeur pour douche à encaissement, pomme de douche en laiton.  
Unterputz-Duscheneinhebelmischer, Kopfbrause in Messing.  
Monomando ducha para empotrar, rociador en latón.  
Однорычажный встроенный смеситель для душа, верхний душ из латуни.

Articolo	Note	CROMO	PV	C	BEO
MR0015WB		502,00	518,00	677,00*	903,00*

**MR0013KB**

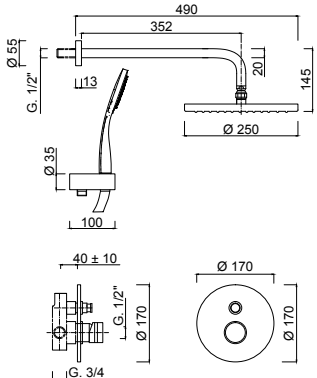

**Set doccia incasso monocomando con deviatore, soffione ottone, kit duplex incasso**  
Shower built-in single-lever mixer with diverter, brass shower head, built-in duplex shower kit.  
Mitigeur pour douche à encaissement avec inverseur, pomme de douche en laiton, ensemble de douche duplex à encaissement.  
Unterputz-Duscheneinhebelmischer mit Umstellung, Brausekopf in Messing, Einbau-Brauseset Duplex.  
Monomando ducha para empotrar con desviador, rociador ducha en latón, conjunto ducha duplex para empotrar.  
Однорычажный встроенный смеситель для душа с дивертером, верхний душ из латуни, встроенный душевой набор "Duplex".

Articolo	Note	CROMO	PV	C	BEO
MR0013KB		705,00	721,00	951,00*	1.269,00*

**MR0013-3KBS**

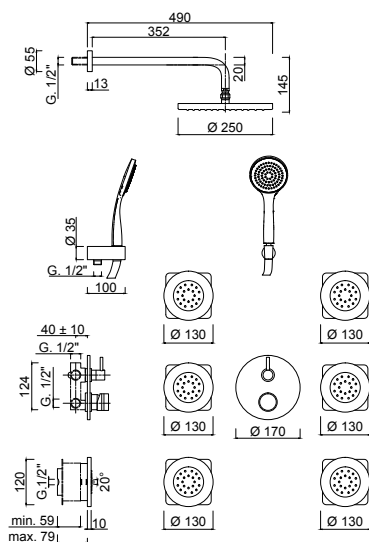

**Set doccia incasso monocomando con deviatore 3 uscite, soffione ottone, kit duplex incasso, 6 soffioncini incasso laterali**  
3 outlets built-in single-lever shower mixer, brass shower head, built-in duplex shower kit, 6 built-in body sprays.  
Mitigeur pour douche à encaissement à 3 sorties, pomme de douche en laiton, ensemble de douche duplex à encaissement, 6 douchettes latérales murales.  
3-Ausgänge Unterputz-Duscheneinhebelmischer, Kopfbrause in Messing, Einbaubrauseset Duplex, 6 Einbauseitenbrausen.  
Monomando ducha para empotrar a 3 salidas, rociador ducha en latón, conjunto de ducha duplex para empotrar, 6 duchas laterales de pared.  
Однорычажный встроенный смеситель для душа с дивертером на 3 выхода, верхний душ из латуни, встроенный душевой набор "Duplex", 6 встроенных боковых форсунок.

Articolo	Note	CROMO	PV	C	BEO
MR0013-3KBS		1.493,00	1.509,00	•	•

**MR0115**

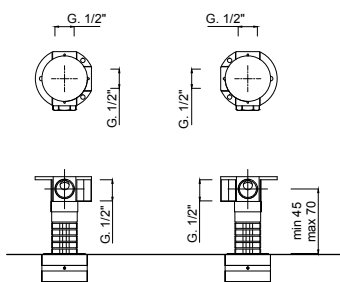

**Rubinetto incasso doccia**  
Concealed shower taps.  
Mélangeur douche encastré.  
Unterputz-Brausebatterie.  
Grupo ducha empotrar.  
Встроенные краны для душа.

Articolo	Note	CROMO	PV	C	BEO
MR0115		304,00	320,00	364,00	547,00

**MR0115W2**

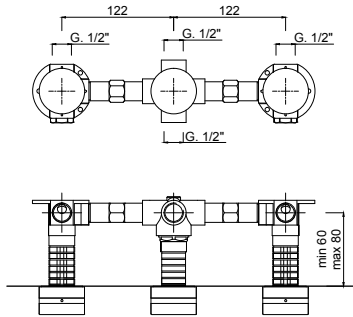
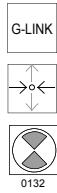

**Rubinetti incasso doccia e deviatore 2 uscite.**

*Concealed shower taps and 2 outlets diverter.  
Mélangeur douche encastré et inverseur 2 sorties.  
Unterputz-Brausebatterie mit 2-Ausgänge Umstellung.  
Grupo ducha empotrar y desviador 2 salidas.  
Встроенные краны для душа и дивертер на 2 выхода.*

Articolo	Note	CROMO	PV	C	BEO
<b>MR0115W2</b>		502,00	518,00	602,00	903,00

**MR0015**

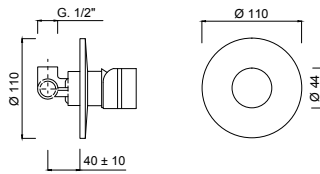

**Monocomando doccia incasso.**

*Shower built-in single-lever mixer.  
Mitigeur pour douche à encaissement.  
Unterputz-Duscheneinhebelmischer.  
Monomando ducha para empotrar.  
Однорычажный встроенный смеситель для душа.*

Articolo	Note	CROMO	PV	C	BEO
<b>MR0015</b>		118,00	134,00	141,00	212,00

**MR0013**

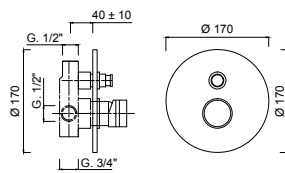
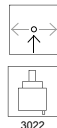

**Monocomando doccia incasso con deviatore**

*Shower built-in single-lever mixer with diverter.  
Mitigeur pour douche à encaissement avec inverseur.  
Unterputz- Duscheneinhebelmischer mit Umstellung.  
Monomando ducha para empotrar con desviador.  
Однорычажный встроенный смеситель для душа с дивертером.*

Articolo	Note	CROMO	PV	C	BEO
<b>MR0013</b>		217,00	233,00	260,00	390,00

**MR0013-3**

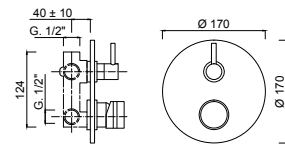
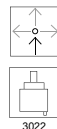

**Monocomando doccia incasso con deviatore 3 uscite**

*Shower built-in single-lever mixer with 3 outlets diverter.  
Mitigeur pour douche à encaissement avec inverseur à 3 sorties.  
Unterputz- Duscheneinhebelmischer mit 3-Ausgänge Umstellung.  
Monomando ducha para empotrar con desviador a 3 salidas.  
Однорычажный встроенный смеситель для душа с дивертером на 3 выхода.*

Articolo	Note	CROMO	PV	C	BEO
<b>MR0013-3</b>		289,00	305,00	346,00	520,00

**MR0013-4**

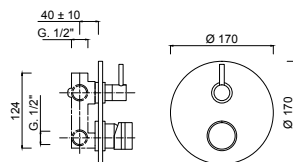
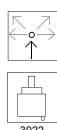

**Monocomando doccia incasso con deviatore 4 uscite**

*Shower built-in single-lever mixer with 4 outlets diverter.  
Mitigeur pour douche à encaissement avec inverseur à 4 sorties.  
Unterputz- Duscheneinhebelmischer mit 4-Ausgänge Umstellung.  
Monomando ducha para empotrar con desviador a 4 salidas.  
Однорычажный встроенный смеситель для душа с дивертером на 4 выхода.*

Articolo	Note	CROMO	PV	C	BEO
<b>MR0013-4</b>		306,00	322,00	363,00	550,00



**MR0813**

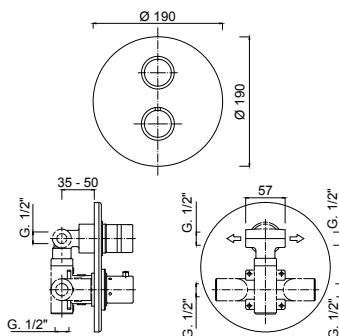

**Termostatico incasso 2 uscite**

2 outlets built-in thermostatic mixer.  
Mitigeur thermostatique mural à 2 sorties.  
2-Ausgänge Eingebaute Einhebel-Thermostatbatterie.  
Mezclador termostatico a empotrar a 2 salidas.  
Встроенный термостатический смеситель на 2 выхода.

Articolo	Note	CROMO	PV	C	BEO
MR0813		550,00	566,00	•	•

**1610**

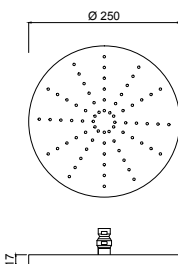

**Soffione doccia anticalcare Ø 250. Ottone**

250 mm diameter shower head, anti limestone, in brass.  
Pomme de douche anticalcaire Ø 250 mm en laiton.  
Kopfbrause, Antikalk System Ø 250 mm, in Messing.  
Rociador antical Ø 250 mm, en latón.  
Верхний душ Ø 250 мм, защита от известняка, латунь.

Articolo	Note	CROMO	PV	C	BEO
1610		325,00	•	•	•

**1611**

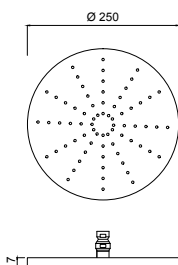

**Soffione doccia anticalcare Ø 250. Abs**

250 mm diameter shower head, anti limestone, Abs.  
Pomme de douche anticalcaire Ø 250 mm. Abs.  
Kopfbrause, Antikalk System Ø 250 mm. Abs.  
Rociador antical Ø 250 mm. Abs.  
Верхний душ Ø 250 мм, защита от известняка. Abs

Articolo	Note	CROMO	PV	C	BEO
1611		182,00	•	•	•

**1612**

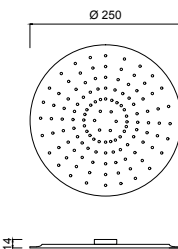

**Soffione doccia anticalcare Ø 250. Inox.**

Shower head, anti limestone, Ø 250 mm. Stainless steel.  
Pomme de douche anticalcaire Ø 250 mm. Inox.  
Kopfbrause, Antikalk System Ø 250 mm. Inox.  
Rociador antical Ø 250 mm. Inoxidable.  
Верхний душ, защита от известняка, Ø 250 мм, нержавеющая сталь.

Articolo	Note	CROMO	PV	C	BEO
1612		253,00	•	•	•

**1751-35**

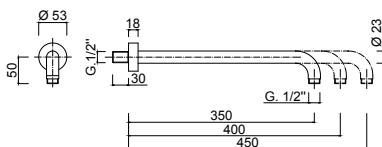

**Braccio doccia in ottone da mm 350.**

Brass shower arm, length mm 350.  
Bras de douche, laiton chromé, longueur mm 350.  
Wandarm, mm 350 Länge, verchromtes Messing.  
Brazo ducha largo 350 mm, latón cromado.  
Душевой кронштейн из латуни, длина 350 мм.

Articolo	Note	CROMO	PV	C	BEO
1751-35	mm 350	78,00	•	112,00	156,00
1751-40	mm 400	83,00	•	•	•
1751-45	mm 450	98,00	•	•	•



1762-10

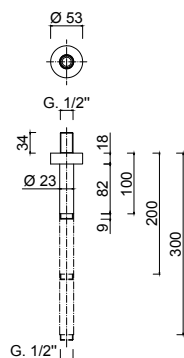

**Braccio doccia da soffitto mm.100.**

Ceiling shower arm mm 100.

Bras de douche vertical mm 100.

Brausearm für Deckenmontage mm 100.

Brazo de ducha a techo mm 100.

Держатель душа 100 мм, потолочный

Articolo	Note	CROMO	PV	C	BEO
1762-10	mm 100	52,00	•	78,00	102,00
1762-20	mm 200	61,00	•	•	•
1762-30	mm 300	70,00	•	•	•

1614

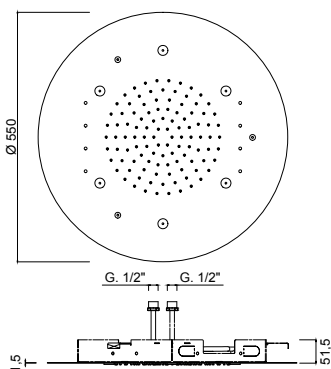
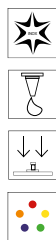

**Soffione inox incasso Ø 550, con getto pioggia, 6 nebulizzatori, sistema di cromoterapia 7 colori con comando remoto touch wireless.**

Ø 550 ceiling-mounted showerhead in inox stainless steel with rain flow, 6 spray jets, 7-colours LED lights for chromotherapy with touch screen wireless remote-control.

Ciel de pluie en acier inox Ø 550 avec jet à pluie, 6 jets d'eau brumisée, LED pour la chromothérapie en 7 couleurs avec télécommande à l'écran tactile sans fils.

Edelstahl Kopfbrause Ø 550 mit Regendusche, 6 Wasserstrahlen Spray, LED Farbtherapie in 7 Farben mit Touch Screen kabelloser Fernbedienung.

Rociador a techo inox Ø 550 con chorro lluvia, 6 chorros de agua pulverizada, LED luz cromoterapia en 7 colores con control remoto touch screen sin cables.

Верхний душ Ø 550 потолочного монтажа из нержавеющей стали с функцией дождя, 6 распылительных форсунок, функция хромотерапии с 7 LED цветами, регулируемая посредством дистанционного сенсорного пульта.

Articolo	Note	CROMO	PV	C	BEO
1614		2.315,00	•	•	•

1615

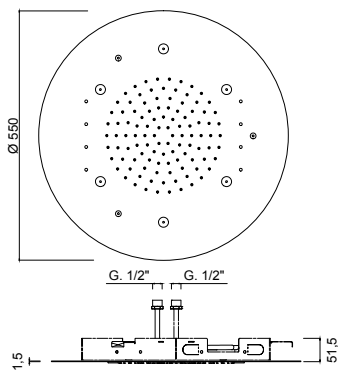

**Soffione inox incasso Ø 550, con getto pioggia, 6 nebulizzatori.**

Inox stainless steel shower head Ø 550, with rain flow, 6 spray jets.

Ciel de pluie en acier inox Ø 550 avec jet à pluie, 6 jets d'eau brumisée.

Edelstahl Kopfbrause Ø 550 mit Regendusche, 6 Wasserstrahlen Spray.

Rociador a techo inox Ø 550 con chorro lluvia, 6 chorros de agua pulverizada.

Верхний душ Ø 550 из нержавеющей стали с функцией дождя, 6 распылительных форсунок.

Articolo	Note	CROMO	PV	C	BEO
1615		1.155,00	•	•	•

1726-50

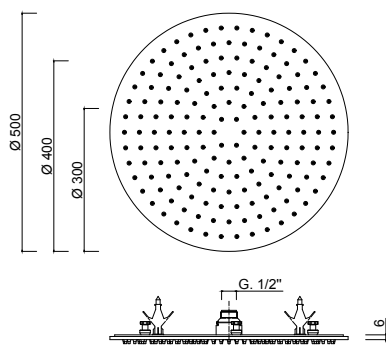

**Soffione inox incasso Ø 550, con getto pioggia.**

Ceiling-mounted stainless steel shower head Ø 550, with rainfall jet.

Ciel de pluie à encastrer au plafond en acier inox Ø 550 avec jet à pluie.

Kopfbrause Inox für Deckeneinbau Ø 550, mit Regenstrahl.

Rociador Inox de techo empotrado Ø 550, con chorro lluvia.

Верхний душ Ø 550 из нержавеющей стали с функцией дождя.

Articolo	Note	CROMO	PV	C	BEO
1726-50	mm 500	1.070,00	•	1.436,00	1.518,00
1726-40	mm 400	820,00	•	1.139,00	1.222,00
1726-30	mm 300	670,00	•	935,00	1.018,00

1625

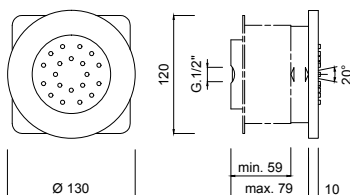

**Soffioncino orientabile laterale incasso.**  
Built-in adjustable lateral body spray.  
Douchette latérale murale orientable.  
Verstellbare UP-Seitenkörperbrause.  
Ducha lateral de pared ajustable.  
Встроенная регулируемая боковая форсунка.

Articolo	Note	CROMO	PV	C	BEO
1625		110,00	•	•	•

1626

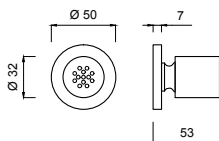

**Soffioncino orientabile laterale esterno**  
External adjustable lateral body spray.  
Douchette latérale extérieure orientable.  
Externe verstellbare Seitenkörperbrause.  
Ducha lateral externa ajustable.  
Боковая регулируемая форсунка наружного монтажа.

Articolo	Note	CROMO	PV	C	BEO
1626		35,00	•	•	•

1543

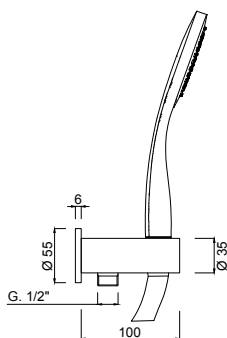

**Kit duplex incasso MyRing.**  
Built-in duplex shower kit MyRing.  
Ensemble de douche duplex à encaissement MyRing.  
Einbaubrauseset Duplex MyRing.  
Conjunto de ducha duplex para empotrar MyRing.  
встроенный душевой набор "Duplex" MyRing.

Articolo	Note	CROMO	PV	C	BEO
1543		110,00	•	•	•

1628

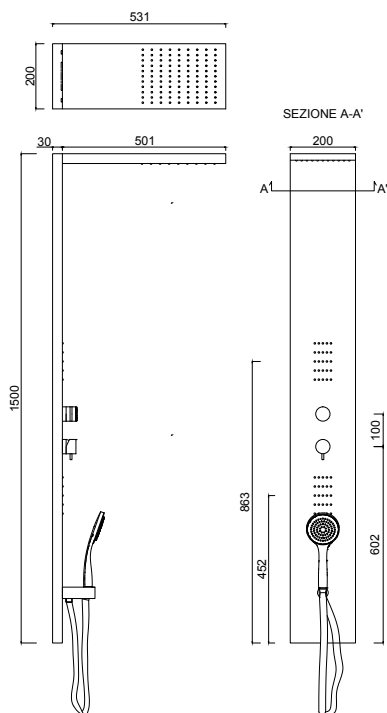

**Completo colonna doccia esterna monocomando, soffione pioggia, kit duplex, soffioncini frontali**  
Complete shower column with single-lever mixer, shower head with rain flow, duplex shower kit, frontal body sprays.  
Colonne de douche complète avec mitigeur, ciel de pluie avec jet à pluie, ensemble de douche duplex, douchettes frontales.  
Komplette Standbrause mit Duscheneinhebelmischer, Kopfbrause mit Regendusche, Brauseset Duplex, Körperbrausen.  
Columna ducha completa con monomando, rociador con chorro lluvia, conjunto de ducha duplex, duchas frontales.  
Цельная душевая колонна с однорычажным смесителем, верхний душ с функцией дождя, душевой набор "Duplex", фронтальные боковые форсунки.

Articolo	Note	CROMO	PV	C	BEO
1628		1.645,00	1.660,00	•	•

1629

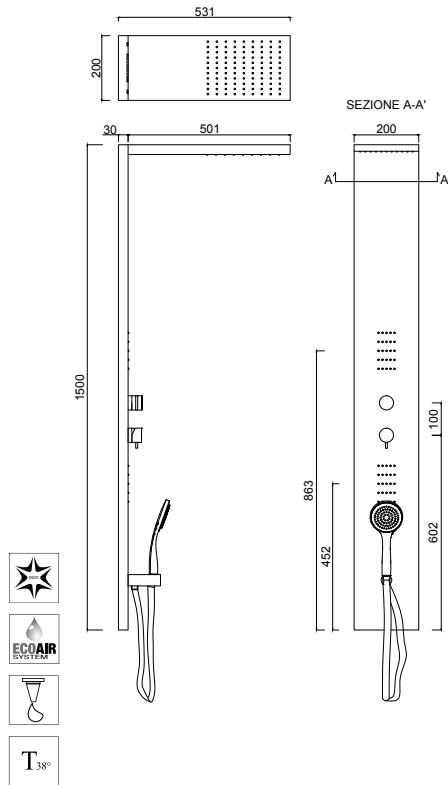

**Completo colonna doccia esterna termostatico, soffione pioggia, kit duplex, soffioncini frontali**

Complete shower column with thermostatic mixer, shower head with rain flow, duplex shower kit, frontal body sprays.

Colonne de douche complète avec mitigeur thermostatique, ciel de pluie avec jet à pluie, ensemble de douche duplex, douchettes frontales.

Komplette Standbrause mit Einhebelthermostatabatterie, Kopfbrause mit Regendusche, Brauseset Duplex, Körperbrausen.

Columna ducha completa con mezclador termostático, rociador con chorro lluvia, conjunto de ducha duplex, duchas frontales.

Цельная душевая колонна с термостатическим смесителем, верхний душ с функцией дождя, душевой набор "Duplex", фронтальные боковые форсунки.

Articolo	Note	CROMO	PV	C	BEO
1629		1.903,00	1.918,00	•	•

MR0107WC-S

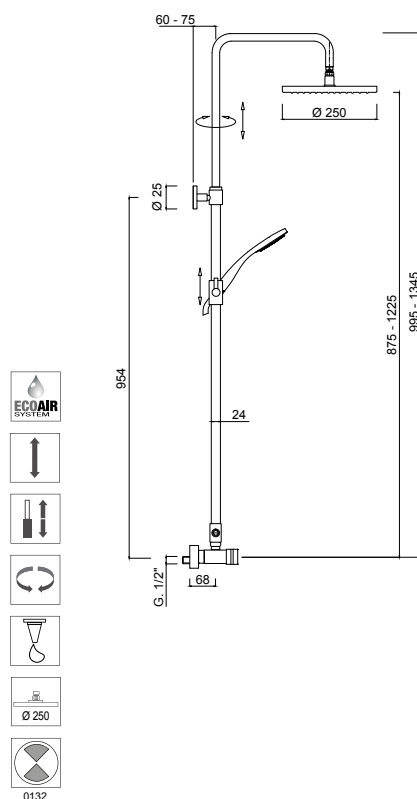

**Colonna doccia esterna, set doccia, soffione in ottone**

External shower column, shower kit, brass shower head.

Colonne de douche extérieure, ensemble de douche, pomme de douche en laiton.

Aufputz-Standbrause, Brauseset, Kopfbrause in Messing.

Columna ducha externa, conjunto de ducha, rociador en latón.

Душевая колонна внешнего монтажа, душевой набор, верхний душ из латуни.

Articolo	Note	CROMO	PV	C	BEO
MR0107WC-S		1.018,00	1.034,00	•	•



**MR0008SWC-S**

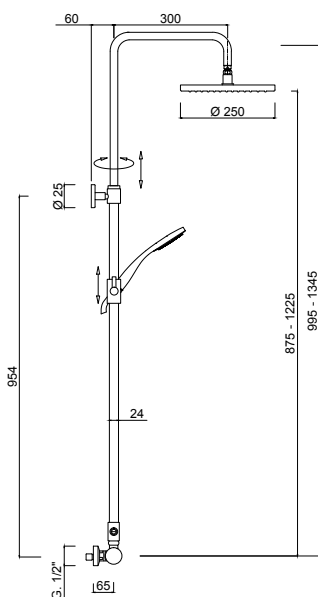

**Colonna doccia esterna monocomando, set doccia, soffione in ottone**

External single-lever shower mixer with shower column, shower kit, brass shower head.

Mitigeur de douche avec colonne de douche, ensemble de douche, pomme de douche en laiton.

Brausemischer mit Säulenbrause, Brauseset, Kopfbrause in Messing. Monomando con columna para ducha, conjunto de ducha, rociador en latón.

Однорычажный смеситель для душа внешнего монтажа с душевой колонной, душевой набор, верхний душ из латуни.

Articolo	Note	CROMO	PV	C	BEO
<b>MR0008SWC-S</b>		1.045,00	1.060,00	•	•

**MR0810WC-S**

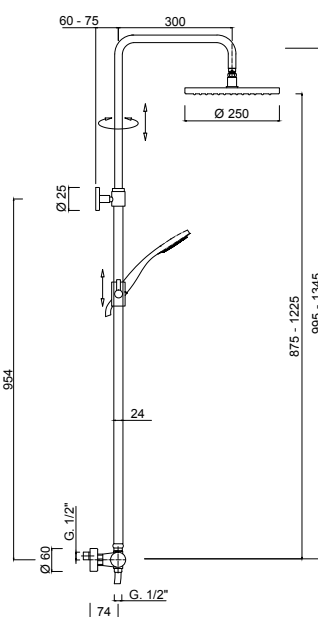

**Colonna doccia esterna termostatica, set doccia, soffione in ottone**

External thermostatic shower column, shower kit, brass shower head. Colonne de douche avec mélangeur thermostatique, ensemble de douche, pomme de douche en laiton.

Aufputz- Standbrause mit Thermostat-Brausebatterie, Brauseset, Kopfbrause in Messing.

Columna ducha con mezclador termostático, conjunto de ducha, rociador ducha en latón.

Термостатическая душевая колонна внешнего монтажа, душевой набор, верхний душ из латуни.

Articolo	Note	CROMO	PV	C	BEO
<b>MR0810WC-S</b>		1.080,00	1.096,00	•	•

**MR0107WS**

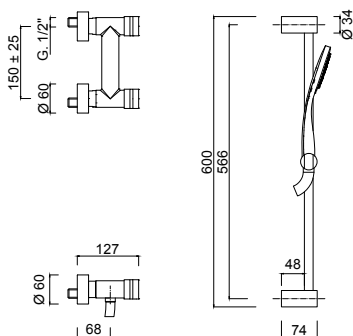
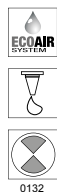

**Gruppo doccia esterno con saliscendi e doccia**

External shower mixer with sliding rail set.  
Mitigeur extérieur de douche avec barre coulissante et ensemble de douche.  
Aufputz-Brausebatterie mit Brausestange und Brauseset.  
Grupo ducha externo con conjunto ducha.  
Смеситель для душа внешнего монтажа с комплектом штанги для душа.

Articolo	Note	CROMO	PV	C	BEO
MR0107WS		413,00	429,00	495,00*	743,00*

**MR0008WS**

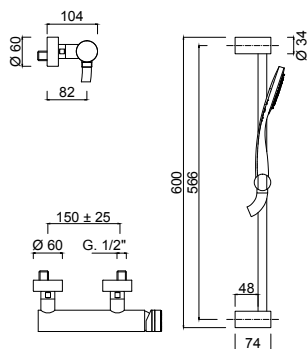
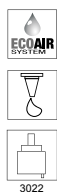

**Monocomando doccia esterno con saliscendi e doccia.**

Single-lever shower mixer with sliding rail set.  
Mitigeur douche mural avec barre coulissante et ensemble de douche.  
Aufputz- Einhebelbrausebatterie mit Brausestange und Brauseset.  
Monomando ducha exterior con conjunto ducha.  
Однорычажный смеситель для душа с комплектом штанги для душа.

Articolo	Note	CROMO	PV	C	BEO
MR0008WS		399,00	414,00	538,00*	718,00*

**MR0107**

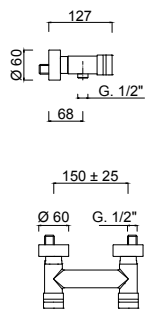

**Gruppo doccia esterno**

External shower mixer.  
Mélangeur extérieur de douche.  
Aufputz- Brausebatterie.  
Grupo ducha externo.  
Смеситель для душа внешнего монтажа.

Articolo	Note	CROMO	PV	C	BEO
MR0107		251,00	267,00	301,00	451,00

**MR0008**

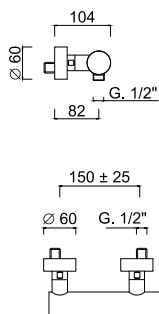

**Monocomando doccia esterno**

External single-lever shower mixer.  
Mitigeur pour douche externe.  
Aufputz-Einhebelbatterie.  
Monomando ducha externo.  
Однорычажный смеситель внешнего монтажа для душа.

Articolo	Note	CROMO	PV	C	BEO
MR0008		262,00	278,00	314,00	471,00

**MR0008S**

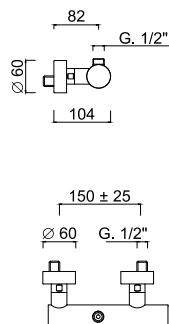

**Monocomando doccia esterno (attacco superiore)**

External single-lever shower mixer (upper connection).  
Mitigeur douche (connection supérieure).  
Aufputz- Brausemischer (oberer Anschluss).  
Misturador para ducha (conexión superior).  
Однорычажный смеситель для душа внешнего монтажа (подключение сверху).

Articolo	Note	CROMO	PV	C	BEO
MR0008S		262,00	278,00	314,00	471,00

**MR0808**

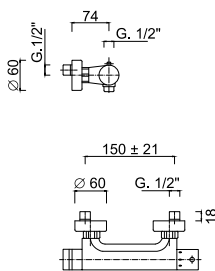

**Termostatico doccia esterno attacco da ½"**  
External thermostatic shower mixer with ½" connection.  
Mitigeur thermostatique pour douche ½".  
Thermostat-Brausebatterie ½".  
Mezclador termostático externo ducha ½".  
Термостатический смеситель внешнего монтажа с соединением 1/2".

Articolo	Note	CROMO	PV	C	BEO
<b>MR0808</b>		358,00	374,00	•	•

**MR0101**

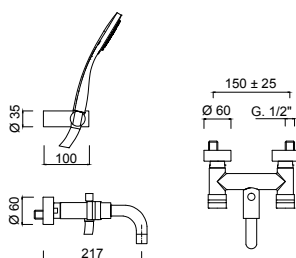

**Gruppo vasca esterno con set doccia duplex**  
External bathtub set with duplex shower kit.  
Mélangeur bain-douche extérieur avec ensemble de douche duplex.  
Wannenbatterie mit Schlauch-Handbrause und verstellbarem Wandhalter.  
Grupo bañera externo con conjunto de ducha duplex.  
Комплект для ванны внешнего монтажа с душевым набором "Duplex".

Articolo	Note	CROMO	PV	C	BEO
<b>MR0101</b>		401,00	421,00	481,00	721,00

**MR0001**

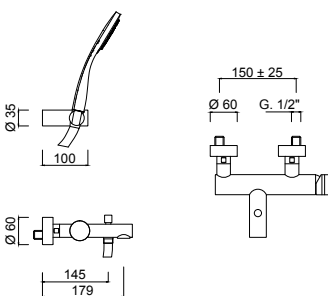
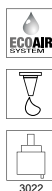

**Monocomando vasca esterno con set doccia duplex.**  
External bathtub single-lever mixer with duplex shower kit.  
Mitigeur bain/douche mural avec ensemble de douche duplex.  
Aufputz- Einhebelmischer mit Brauseset Duplex.  
Monomando bañera externo con conjunto de ducha duplex.  
Однорычажный смеситель внешнего монтажа для ванны с душевым набором "Duplex".

Articolo	Note	CROMO	PV	C	BEO
<b>MR0001</b>		416,00	436,00	499,00	748,00

**MR0160**

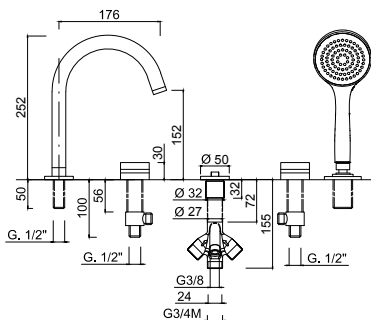

**Batteria bordo vasca 5 fori**  
5-hole bath border set.  
Mélangeur bain/douche sur gorge 5 trous.  
5-Loch Wannen Kombination.  
Bimando bañera de repisa 5 agujeros.  
Комплект на борт ванны на 5 отверстий.

Articolo	Note	CROMO	PV	C	BEO
<b>MR0160</b>		523,00	575,00	627,00*	941,00*

**MR0065BD**

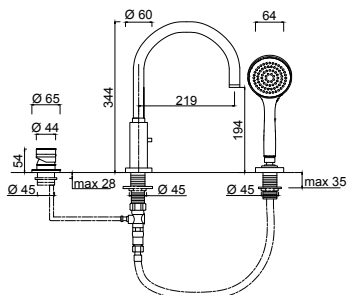

**Monocomando bordo vasca 3 fori, bocca con deviatore**  
3-hole single-lever mixer deck-mounted for bath's border, spout with diverter.  
Mélangeur à 3 trous, bec avec déviateur.  
3-Loch Wannenmischer, Auslauf mit Umstellung.  
Monomando baño sobre repisa con 3 agujeros, caño con desviación.  
Однорычажный смеситель на борт ванны на 3 отверстия, излив с дивертером.

Articolo	Note	CROMO	PV	C	BEO
<b>MR0065BD</b>		445,00	489,00	434,00*	801,00*

MR0092

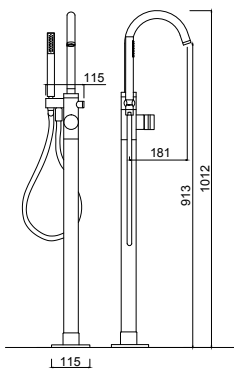

**Monocomando vasca a pavimento (con scatola incasso)**  
Free-standing bath mixer (with built-in box).  
Mélangeur baignoire à terre (avec la boîte murale).  
Wannenmischer mit Standfuss Schlauch (mit Montagedose auf dem Boden).  
Monomando bañera a pavimento (con caja de montaje en el suelo).  
Свободно-стоящий смеситель для ванны (со встраиваемой коробкой).

Articolo	Note	CROMO	PV	C	BEO
MR0092		1.721,00	1.737,00	•	•

5102L

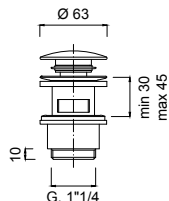

**Scarico per lavabo Up&Down 1"1/4.**  
Basin drain 1"1/4 Up&Down.  
Vidage lavabo Up&Down 1"1/4.  
Ablaufgarnitur Up&Down 1"1/4.  
Desague automatico Up&Down 1"1/4.  
Слив для раковины Up&Down 1"1/4.

Articolo	Note	CROMO	PV	C	BEO
5102L		45,00	•	63,00	81,00

5105L

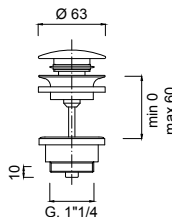

**Scarico per lavabo Up&Down 1"1/4.**  
Basin drain 1"1/4 Up&Down.  
Vidage lavabo Up&Down 1"1/4.  
Ablaufgarnitur Up&Down 1"1/4.  
Desague automatico Up&Down 1"1/4.  
Слив для раковины Up&Down 1"1/4.

Articolo	Note	CROMO	PV	C	BEO
5105L		45,00	•	63,00	81,00

5109L

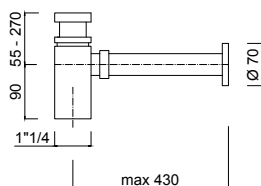

**Sifone per Lavabo 1"1/4.**  
Trap for basin 1"1/4.  
Siphon lavabo 1"1/4.  
Röhrensifon Waschtisch 1"1/4.  
Sifon para lavabo 1"1/4.  
Сифон для раковины 1"1/4.

Articolo	Note	CROMO	PV	C	BEO
5109L		90,00	•	135,00	162,00

3264L

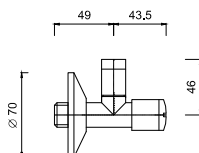

**Rubinetto sottolavabo con filterstop.**  
Under-sink valve with filterstop.  
Coude sous lavabo avec filterstop.  
Eckventile mit Filter.  
Llave de paso para lavabo con filterstop.  
Вентиль под раковину с filterstop.

Articolo	Note	CROMO	PV	C	BEO
3264L		48,00	•	70,00	87,00



1620

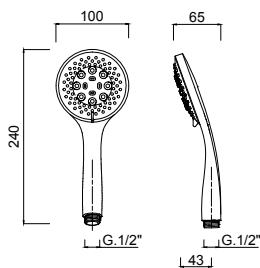

**Doccetta 3 getti idromassaggio**

Hand-shower 3 massage jets.  
Douchette à 3 jets de massage.  
3- Massagestrahle Handbrause.  
Ducha de mano 3 posiciones con chorro de massage.  
Ручной душ, 3 массажных режима.

Articolo	Note	CROMO	PV	C	BEO
1620		72,00	•	•	•

1621

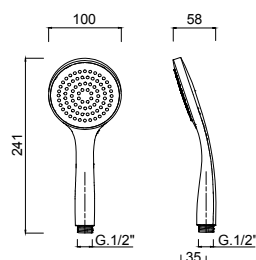

**Doccetta monogetto MyRing**

MyRing 1 jet handshower.  
Douchette 1 jet MyRing.  
Handbrause 1 Strahl MyRing.  
Ducha de mano 1 chorro MyRing.  
Ручной душ MyRing, один режим.

Articolo	Note	CROMO	PV	C	BEO
1621		50,00	•	•	•

1623

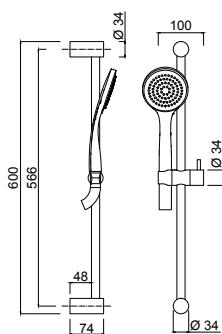

**Saliscendi in ottone con doccia monogetto MyRing.**

Brass sliding bar and MyRing 1 jet handshower.  
Barre de douche en laiton avec douchette 1 jet MyRing.  
Brausestange in Messing mit Handbrause 1 Strahl MyRing.  
Barra deslizante en latón con ducha teléfono 1 chorro MyRing.  
Штанга для душа и ручной душ MyRing, один режим.

Articolo	Note	CROMO	PV	C	BEO
1623		170,00	•	•	•

1510CL

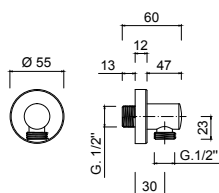

**Presa acqua 1/2".**

Water plug 1/2".  
Prise d'eau mural 1/2".  
Wandanschlussbogen 1/2" für Brauseanschl. .  
Toma de agua 1/2".  
Крепление к стене для гибкого шланга

Articolo	Note	CROMO	PV	C	BEO
1510CL		25,00	•	48,00	50,00

**NOTE**

**Potete trovare altre soluzioni per la Doccia nell'area WELLNESS. p.374**  
For additional Shower options please go to WELLNESS section.  
Pour plus de solutions pour la Douche visitez la section WELLNESS.  
Für weitere Duschalternativen sehen Sie bitte in dem Kapitel WELLNESS nach.  
Para más soluciones para Ducha visite la sección WELLNESS.  
Другие решения для Душа вы найдете в разделе Wellness.

**Per gli Accessori Bagno abbinati alla serie potete consultare la serie MODERNA. p.446**  
For matching Bathroom Fittings please check MODERNA line.  
Pour les Accessoires Salle de Bains coordonnés à la collection visitez la ligne MODERNA.  
Die zu der Serie passenden Bad-Accessoires finden Sie in dem Linie MODERNA.  
Para los Accesorios de Baño compatibles con la serie visite la línea MODERNA.  
Чтобы подобрать подходящие аксессуары для ванной комнаты, перейдите в Линия MODERNA.

Surf







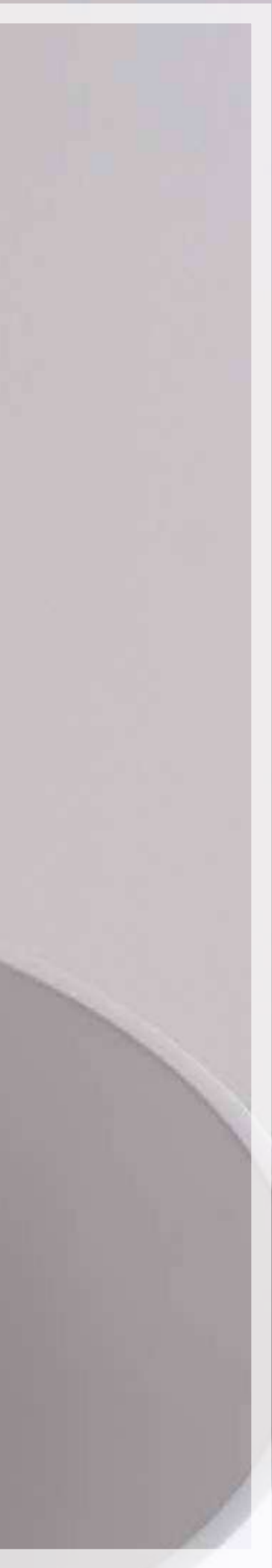











### 5805A

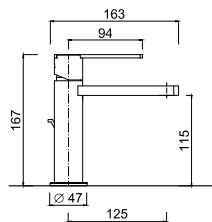

#### Monocomando lavabo, scarico 1"1/4 (con flessibile)

Wash-basin single-lever mixer, 1"1/4 pop-up waste (with flexible).  
Mitigeur lavabo avec vidage 1"1/4 (avec flexible).  
Einhand-Waschtischbatterie mit Ablaufgarnitur 1"1/4 (mit flexiblen Anschlussschläuchen).  
Monomando lavabo tapón accionado por varilla 1"1/4 (con flexible).  
Однорычажный смеситель для раковины, донный клапан 1"1/4 (гибкая подводка).

Articolo	Note	CROMO	BO-NO-NKO	LV	BEO
5805A		252,00	378,00	272,00	453,00
5805/SC	SC	239,00	359,00	259,00	430,00

### 5811A

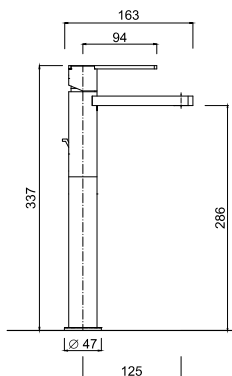

#### Monocomando lavabo con prolunga, scarico 1"1/4 (con flessibile)

High wash-basin single-lever mixer, 1"1/4 pop-up waste (with flexible).  
Mitigeur lavabo avec bec haut et vidage 1"1/4 (avec flexible).  
Einhand-Waschtischbatterie mit hohem Auslauf und Ablaufgarnitur 1"1/4 (mit flexiblen Anschlussschläuchen).  
Monomando lavabo alto tapón accionado por varilla 1"1/4 (con flexible).  
Высокий однорычажный смеситель для раковины, донный клапан 1"1/4 (гибкая подводка).

Articolo	Note	CROMO	BO-NO-NKO	LV	BEO
5811A		319,00	479,00	339,00	574,00
5811/SC	SC	306,00	460,00	326,00	550,00

### 5839A

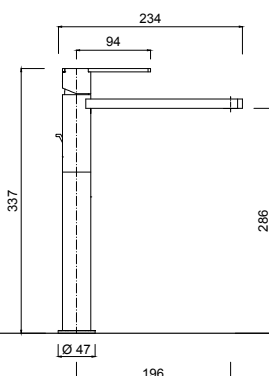

#### Monocomando lavabo con prolunga, bocca lunga, scarico 1"1/4 (con flessibile)

High wash-basin single-lever mixer with long spout, 1"1/4 pop-up waste (with flex.).  
Mitigeur lavabo haut avec bec long, avec vidage 1"1/4 (avec flexible).  
Einhand-Waschtischbatterie mit hohem und langem Auslauf, mit Ablaufgarnitur 1"1/4 (mit flexiblen Anschlussschläuchen).  
Monomando lavabo alto con caño longo, tapón accionado por varilla 1"1/4 (con flex.).  
Высокий однорычажный смеситель для раковины с удлиненным изливом, донный клапан 1"1/4 (гибкая подводка).

Articolo	Note	CROMO	BO-NO-NKO	LV	BEO
5839A		371,00	557,00	391,00	667,00
5839/SC	SC	358,00	538,00	378,00	644,00

### 5820

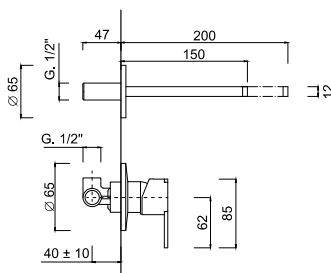

#### Monocomando lavabo a muro, senza scarico

Wall-mounted wash-basin set, without pop-up waste.  
Mitigeur lavabo mural, sans vidage.  
Waschtisch- Einhebelmischer Wandmontage, ohne Ablaufgarnitur.  
Lavabo de pared, sin desagüe.  
Комплект настенного монтажа для раковины, без донного клапана

Articolo	Note	CROMO	BO-NO-NKO	LV	BEO
5820	mm 200	245,00	368,00	275,00	441,00
5820-15	mm 150	245,00	368,00	275,00	441,00

### 5810

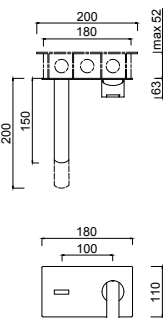

#### Monocomando lavabo a muro, bocca mm 200, box incasso, senza scarico.

Wall-mounted wash-basin mixer, spout mm 200, built-in box, without pop-up waste.  
Mitigeur lavabo mural, bec mm 200, box d'encastrement, sans vidage.  
Einhebel-Waschtischmischer für die Wandmontage, Auslauf mm 200, Einbau-Box, ohne Ablaufgarnitur.  
Monomando lavabo mural, caño mm 200, box empotrado incluido, sin desagüe automatico.  
Смеситель для раковины настенного монтажа, излив 200 мм, встраиваемый бокс, без донного клапана

Articolo	Note	CROMO	BO-NO-NKO	LV	BEO
5810	mm 200	395,00	•	425,00	•
5820-15	mm 150	395,00	•	425,00	•

5890



5 lt/min



3022R

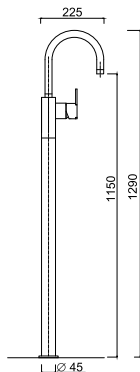

**Monocomando lavabo a pavimento, bocca girevole**

Wash-basin single-lever mixer with floor pillar leg, swivel spout.  
Mitigeur lavabo avec colonnette alimentation par le sol, bec mobile.  
Waschtisch- Einhebelmischer mit Standfuß Schlauch, Rohrauslauf.  
Monomando lavabo con colonna a pavimento, caño giratorio.  
Однорычажный смеситель для раковины с напольной колонной, поворотный излив.

Articolo	Note	CROMO	BO-NO-NKO	LV	BEO
5890		908,00	•	938,00	•

5807A



5 lt/min



3021S

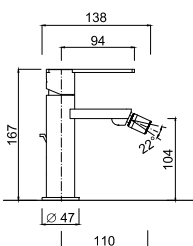

**Monocomando bidet, scarico 1"1/4 (con flessibile).**

Bidet single-lever mixer, 1"1/4 pop-up waste (with flexible).  
Mélangeur bidet avec vidage 1"1/4 (avec flexible).  
Einhand-Bidetbatterie mit Ablaufgarnitur 1"1/4 (mit flexiblen Anschlusschläuchen).  
Monomando bidet, tapón accionado por varilla 1"1/4 (con flexible).  
Однорычажный смеситель для биде, донный клапан 1"1/4 (гибкая подводка).

Articolo	Note	CROMO	BO-NO-NKO	LV	BEO
5807A		252,00	378,00	272,00	453,00

SH25/S



3021FMG

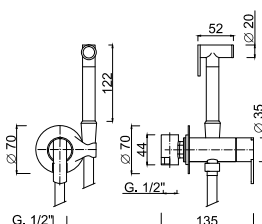

**Miscelatore monocomando incasso per bidet**

Built-in single-lever mixer for bidet  
Mitigeur à encastrer pour bidet  
UP-Einhebelmischer für Bidet  
Monomando empotrado para bidé  
Однорычажный встраиваемый смеситель для биде

Articolo	Note	CROMO	BO-NO-NKO	LV	BEO
SH25/S		165,00	340,00	195,00	•

5815WB



3022

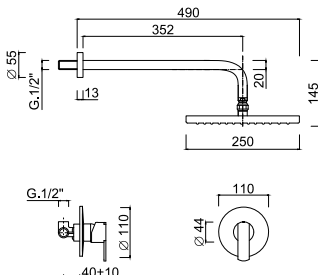

**Set doccia incasso monocomando, soffione Abs**

Concealed single-lever shower mixer, abs shower head.  
Mitigeur pour douche à encaissement, pomme de douche en abs.  
Unterputz-Duscheneinhebelmischer, Kopfbrause in abs.  
Monomando ducha para empotrar, rociador en abs.  
Однорычажный встроенный смеситель для душа, верхний душ ABS.

Articolo	Note	CROMO	BO-NO-NKO	LV	BEO
5815WB		336,00	717,00*	366,00	860,00*

5813KB



3022

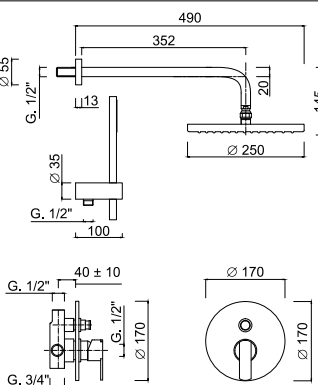

**Set doccia incasso monocomando con deviatore, soffione abs, kit duplex incasso**

Shower built-in single-lever mixer with diverter, abs shower head, built-in duplex shower kit.  
Mitigeur pour douche à encaissement avec inverseur, pomme de douche en abs, ensemble de douche duplex à encaissement.  
Unterputz- Duscheneinhebelmischer mit Umstellung, Brausekopf in Messing, Einbau- Brauseset Duplex.  
Monomando ducha para empotrar con desviador, rociador ducha en abs, conjunto ducha duplex para empotrar.  
Однорычажный встроенный смеситель для душа с дивертером, верхний душ из латуни, встроенный душевой набор "Duplex".

Articolo	Note	CROMO	BO-NO-NKO	LV	BEO
5813KB		515,00	1.058,00*	545,00	1.269,00*



5813-4

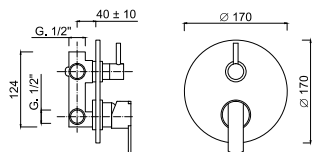
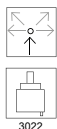

**Monocomando doccia incasso con deviatore 4 uscite**

Shower built-in single-lever mixer with 4 outlets diverter  
Mitigeur pour douche à encaissement avec inverseur à 4 sorties  
Unterputz- Duscheneinhebelmischer mit 4-Augänge Umstellung  
Monomando ducha para empotrar con desviador a 4 salidas  
Однорычажный встроенный смеситель для душа с дивертером на 4 выхода

Articolo	Note	CROMO	BO-NO-NKO	LV	BEO
5813-4		287,00	415,00	317,00	516,00

8212

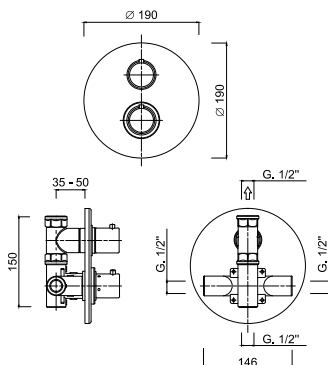

**Termostatico incasso 1/2", con rubinetto d'arresto 1/2".**

Built-in thermostatic mixer 1/2", with built-in tap 1/2".  
Mitigeur thermostatique mural, 1/2", avec robinet mural 1/2".  
Eingebaute Einhebel Thermostatbatterie 1/2", mit Ventil 1/2".  
Mezclador termostatico a empotrar 1/2", con grifo 1/2".  
Встраиваемый термостат 1/2" со встраиваемым смесителем 3/4".

Articolo	Note	CROMO	BO-NO-NKO	LV	BEO
8212		440,00	•	•	•

8213

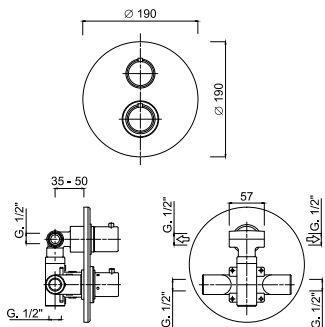
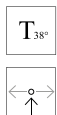

**Termostatico incasso 2 uscite**

Thermostatic incasso 2 uscite  
2 outlets built-in thermostatic mixer.  
Mitigeur thermostatique mural à 2 sorties.  
2-Ausgänge eingebaute Einhebel-Thermostatbatterie.  
Mezclador termostatico a empotrar a 2 salidas.  
Встроенный термостатический смеситель на 2 выхода.

Articolo	Note	CROMO	BO-NO-NKO	LV	BEO
8213		490,00	•	•	•

8276

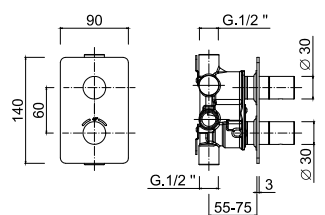
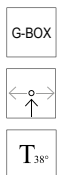

**Termostatico incasso 2 uscite, box incasso.**

Built-in thermostatic mixer with 2 outlets, built-in box.  
Mitigeur thermostatique douche à encastrer avec 2 sorties, box d'encastrement.  
UP-Thermostat mit 2-Wege-Umstellung, inkl. Box.  
Termostática empotrada 2 salidas, box empotrado incluido.  
Встраиваемый термостатический смеситель с 2 выходами, встраиваемый бокс

Articolo	Note	CROMO	BO-NO-NKO	LV	BEO
8276		760,00	•	•	•

8277

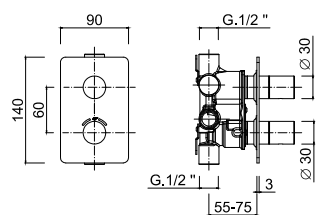
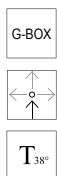

**Termostatico incasso 3 uscite, box incasso.**

Built-in thermostatic mixer with 3 outlets, built-in box.  
Mitigeur thermostatique douche à encastrer avec 3 sorties, box d'encastrement.  
UP-Thermostat mit 3-Wege-Umstellung, inkl. Box.  
Termostática empotrada 3 salidas, box empotrado incluido.  
Встраиваемый термостатический смеситель с 3 выходами, встраиваемый бокс

Articolo	Note	CROMO	BO-NO-NKO	LV	BEO
8277		820,00	•	•	•

8278

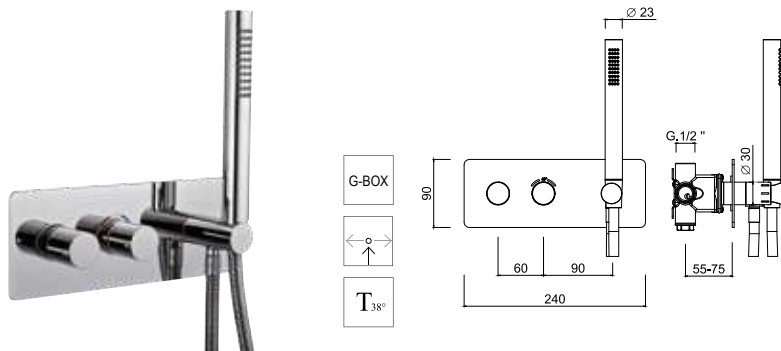

**termostatico incasso, set doccia, 1 uscita libera, box incasso.**  
Built-in thermostatic mixer, integrated shower set + 1 additional water outlet, built-in box.

Mitigeur thermostatique douche à encastrer, ensemble de douche + 1 sortie supplémentaire disponible, box d'encastrement.

UP-Thermostat, integrierte Brauseset + 1 zusätzlicher Verbraucher, inkl. Box.

Termostática empotrada, kit de ducha, 1 salida adicional disponible, box empotrado incluido.

Встраиваемый термостатический смеситель, интегрированный душевой комплект + дополнительный выход воды, встраиваемый бокс

Articolo	Note	CROMO	BO-NO-NKO	LV	BEO
8278		970,00	•	•	•

8279

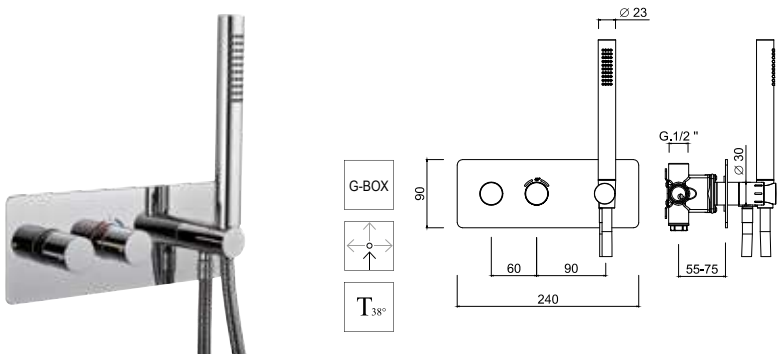

**termostatico incasso, set doccia, 2 uscite libere, box incasso.**

Built-in thermostatic mixer, integrated shower set + 2 additional water outlets, built-in box.

Mitigeur thermostatique douche à encastrer, ensemble de douche + 2 sorties supplémentaires disponibles, box d'encastrement.

UP-Thermostat, integrierte Brauseset + 2 zusätzliche Verbraucher, inkl. Box.

Termostática empotrada, kit de ducha, 2 salidas adicionales disponibles, box empotrado incluido.

Встраиваемый термостатический смеситель, интегрированный душевой комплект + 2 дополнительных выхода воды, встраиваемый бокс

Articolo	Note	CROMO	BO-NO-NKO	LV	BEO
8279		1.025,00	•	•	•

1610



**Soffione doccia anticalcare Ø 250. Ottone**

250 mm diameter shower head, anti limestone, in brass.

Pomme de douche anticalcaire Ø 250 mm en laiton.

Kopfbrause, Antikalk System Ø 250 mm, in Messing.

Rociador antical Ø 250 mm, en latón.

Верхний душ Ø 250 мм, защита от известняка, латунь

Articolo	Note	CROMO	BO-NO-NKO	LV	BEO
1610		325,00	•	•	•

1611



**Soffione doccia anticalcare Ø 250. Abs**

250 mm diameter shower head, anti limestone. Abs

Pomme de douche anticalcaire Ø 250 mm. Abs

Kopfbrause, Antikalk System Ø 250 mm. Abs

Rociador antical Ø 250 mm. Abs

Верхний душ Ø 250 мм, защита от известняка, Abs

Articolo	Note	CROMO	BO-NO-NKO	LV	BEO
1611		182,00	•	•	•

1612

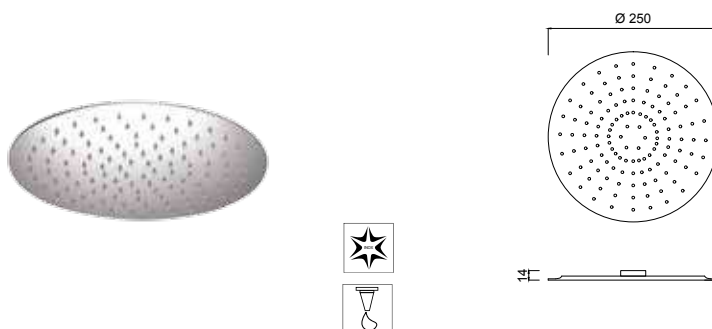

**Soffione doccia anticalcare Ø 250. Inox.**

Shower head, anti limestone, Ø 250 mm. Stainless steel.

Pomme de douche anticalcaire Ø 250 mm. Inox.

Kopfbrause, Antikalk System Ø 250 mm. Inox.

Rociador antical Ø 250 mm. Inoxidable.

Верхний душ, защита от известняка, Ø 250 мм, нержавеющая сталь.

Articolo	Note	CROMO	BO-NO-NKO	LV	BEO
1612		253,00	•	•	•



1751-35

**Braccio doccia in ottone da mm 350.**  
Brass shower arm, length mm 350.  
Bras de douche, laiton chromé, longueur mm 350.  
Wandarm, mm 350 Länge, verchromtes Messing.  
Brazo ducha largo 350 mm, latón cromado.  
Душевой кронштейн из латуни, длина 350 мм.

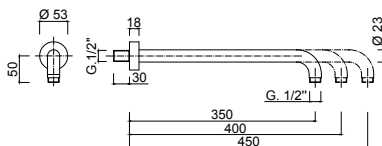

Articolo	Note	CROMO	BO-NO-KNO	LV	BEO
1751-35	mm 350	78,00	112,00	•	156,00
1751-40	mm 400	83,00	•	•	•
1751-45	mm 450	98,00	•	•	•

1762-10

**Braccio doccia da soffitto mm.100.**  
Ceiling shower arm mm 100.  
Bras de douche vertical mm 100.  
Brausearm für Deckenmontage mm 100.  
Brazo de ducha a techo mm 100.  
Держатель душа 100 мм, потолочный

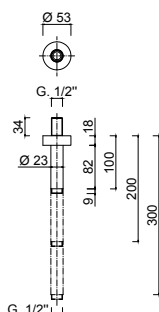

Articolo	Note	CROMO	BO-NO-KNO	LV	BEO
1762-10	mm 100	52,00	78,00	•	102,00
1762-20	mm 200	61,00	•	•	•
1762-30	mm 300	70,00	•	•	•

1613

**Soffione a parete**  
Soffione a parete  
Wall-mounted shower head.  
Pomme de douche murale.  
Kopfbrause zur Wandmontage.  
Rociador de pared.  
Встроенный верхний душ.

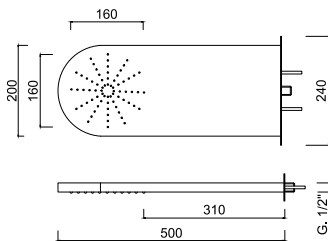

Articolo	Note	CROMO	BO-NO-NKO	LV	BEO
1613		775,00	•	•	•

1614

**Soffione inox incasso Ø 550, con getto pioggia, 6 nebulizzatori, sistema di cromoterapia 7 colori con comando remoto touch wireless.**

Ø 550 ceiling-mounted showerhead in inox stainless steel with rain flow, 6 spray jets, 7-colours LED lights for chromotherapy with touch screen wireless remote-control.

Ciel de pluie en acier inox Ø 550 avec jet à pluie, 6 jets d'eau brumisée, LED pour la chromothérapie en 7 couleurs avec télécommande à l'écran tactile sans fils.

Edelstahl Kopfbrause Ø 550 mit Regendusche, 6 Wasserstrahlen Spray, LED Farbtherapie in 7 Farben mit Touch Screen kabelloser Fernbedienung.

Rociador a techo inox Ø 550 con chorro lluvia, 6 chorros de agua pulverizada, LED luz cromoterapia en 7 colores con control remoto touch screen sin cables.

Верхний душ Ø 550 потолочного монтажа из нержавеющей стали с функцией дождя, 6 распылительных форсунок, функция хромотерапии с 7 LED цветами, регулируемая посредством дистанционного сенсорного пульта.

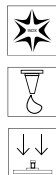
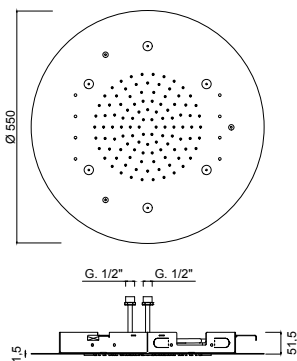

Articolo	Note	CROMO	BO-NO-NKO	LV	BEO
1614		2.315,00	•	•	•



1615

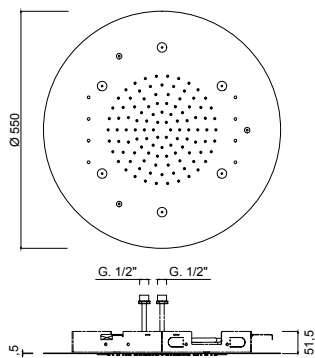

**Soffione inox incasso Ø 550, con getto pioggia, 6 nebulizzatori.**  
Inox stainless steel shower head Ø 550, with rain flow, 6 spray jets.  
Ciel de pluie en acier inox Ø 550 avec jet à pluie, 6 jets d'eau brumisée.  
Edelstahl Kopfbrause Ø 550 mit Regendusche, 6 Wasserstrahlen Spray.  
Rociador a techo inox Ø 550 con chorro lluvia, 6 chorros de agua pulverizada.  
Верхний душ Ø 550 из нержавеющей стали с функцией дождя, 6 распылительных форсунок.

Articolo	Note	CROMO	BO-NO-NKO	LV	BEO
1615		1.155,00	•	•	•

1726-50

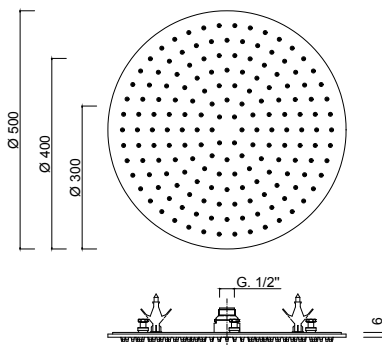

**Soffione inox incasso Ø 550, con getto pioggia.**  
Ceiling-mounted stainless steel shower head Ø 550, with rainfall jet.  
Ciel de pluie à encastrer au plafond en acier inox Ø 550 avec jet à pluie.  
Kopfbrause Inox für Deckeneinbau Ø 550, mit Regenstrahl.  
Rociador Inox de techo empotrado Ø 550, con chorro lluvia.  
Верхний душ Ø 550 из нержавеющей стали с функцией дождя.

Articolo	Note	CROMO	BO-NO-NKO	LV	BEO
1726-50	mm 500	1.070,00	1.436,00	•	1.518,00
1726-40	mm 400	820,00	1.139,00	•	1.222,00
1726-30	mm 300	670,00	935,00	•	1.018,00

1625

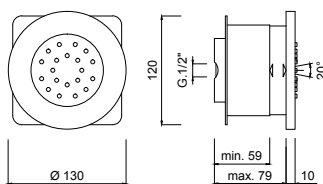

**Soffioncino orientabile laterale incasso.**  
Built-in adjustable lateral body spray.  
Douchette latérale murale orientable.  
Verstellbare UP-Seitenkörperbrause.  
Ducha lateral de pared ajustable.  
Встроенная регулируемая боковая форсунка.

Articolo	Note	CROMO	BO-NO-NKO	LV	BEO
1625		110,00	•	•	•

1626

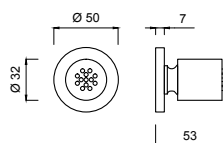

**Soffioncino orientabile laterale esterno**  
External adjustable lateral body spray.  
Douchette latérale extérieure orientable.  
Externe verstellbare Seitenkörperbrause.  
Ducha lateral externa ajustable.  
Боковая регулируемая форсунка наружного монтажа.

Articolo	Note	CROMO	BO-NO-NKO	LV	BEO
1626		35,00	•	•	•

1544

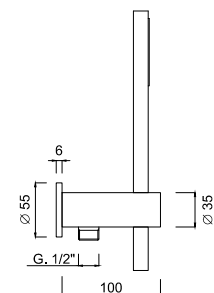

**Kit duplex incasso Surf**  
Built-in duplex shower kit Surf.  
Ensemble de douche duplex à encaissement Surf.  
Einbaubrauseset Duplex Surf.  
Conjunto de ducha duplex para empotrar Surf.  
встроенный душевой набор "Duplex" Surf.

Articolo	Note	CROMO	BO-NO-NKO	LV	BEO
1544		78,00	•	•	•

1630

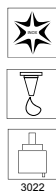
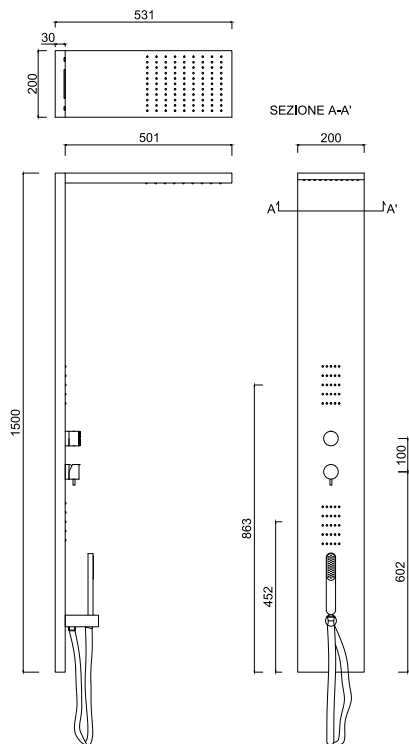

**Completo colonna doccia esterna monocomando, soffione pioggia, kit duplex, soffioncini frontali**  
 Complete shower column with single-lever mixer, shower head with rain flow, duplex shower kit, frontal body sprays.  
 Colonne de douche complète avec mitigeur, ciel de pluie avec jet à pluie, ensemble de douche duplex, douchettes frontales.  
 Komplette Standbrause mit Duscheinhebelmischer, Kopfbrause mit Regendusche, Brauseset Duplex, Körperbrausen.  
 Columna ducha completa con monomando, rociador a techo con chorro lluvia, conjunto de ucha duplex, duchas frontales.  
 Цельная душевая колонна с однорычажным смесителем, верхний душ с функцией дождя, душевой набор "Duplex", фронтальные боковые форсунки.

Articolo	Note	CROMO	BO-NO-NKO	LV	BEO
1630		1.495,00	•	•	•

1631

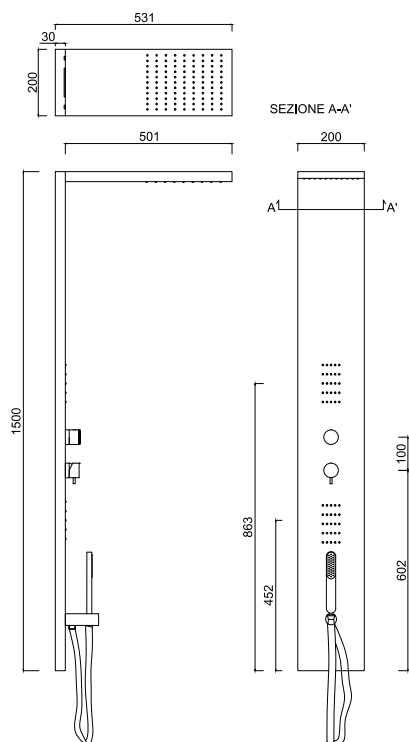

**Completo colonna doccia esterna termostatico, soffione pioggia, kit duplex, soffioncini frontali**  
 Complete shower column with thermostatic mixer, shower head with rain flow, duplex shower kit, frontal body sprays.  
 Colonne de douche complète avec mitigeur thermostatique, ciel de pluie avec jet à pluie, ensemble de douche duplex, douchettes frontales.  
 Komplette Standbrause mit Einhebelthermostatbatterie, Kopfbrause mit Regendusche, Brauseset Duplex, Körperbrausen.  
 Columna ducha completa con mezclador termostatico, rociador a techo con chorro lluvia, conjunto de ducha duplex, duchas frontales.  
 Цельная душевая колонна с термостатическим смесителем, верхний душ с функцией дождя, душевой набор "Duplex", фронтальные боковые форсунки.

Articolo	Note	CROMO	BO-NO-NKO	LV	BEO
1631		1.730,00	•	•	•

1632

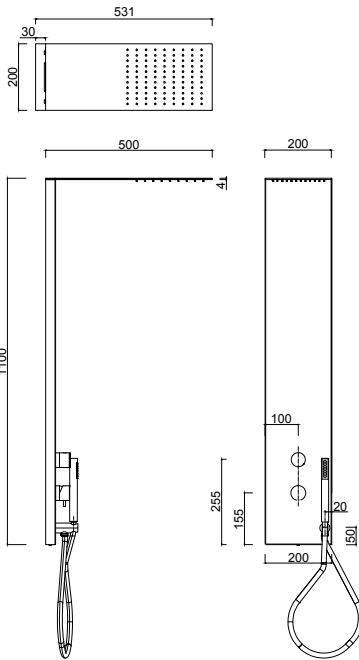

**Colonna doccia esterna con monocomando, soffione pioggia, set doccia.**

Wall-mounted shower column with mixer, rainfall jet and duplex shower kit.

Colonne de douche complète avec mitigeur, ciel de pluie et ensemble de douche.

AP-Duschsäule mit Einhebelmischer, Regendusche und Brauseset. Columna de ducha de superficie con monomando, rociador chorro lluvia, kit de ducha.

Настенная душевая колонна со смесителем, верхним душем с функцией дождя и душевым комплектом "duplex"

Articolo	Note	CROMO	BO-NO-NKO	LV	BEO
1632		950,00	1.650,00	•	•

5808WS

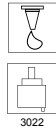
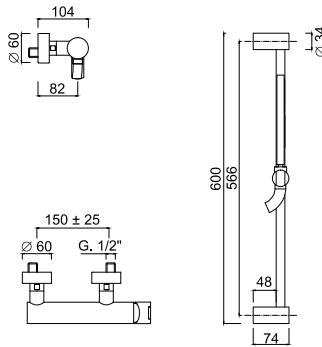

**Monocomando doccia esterno con saliscendi e doccia.**

External single-lever shower mixer with sliding rail set.

Mitigeur extérieure de douche avec barre coulissante et ensemble de douche.

Aufputz- Einhand-Brausebatterie mit Brausestange und Brauseset. Monomando ducha exterior con conjunto de ducha.

Однорычажный смеситель внешнего монтажа для душа с комплектом штанги для душа.

Articolo	Note	CROMO	BO-NO-NKO	LV	BEO
5808WS		300,00	716,00*	330,00	859,00*

8208EXWS

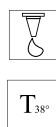
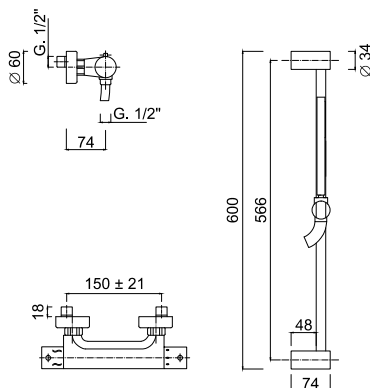

**Termostatico doccia esterno attacco da 1/2 con saliscendi e doccia**

External thermostatic shower mixer with 1/2 connection, with sliding rail set.

Mélangeur thermostatique 1/2 avec barre coulissante et ensemble de douche.

Thermostat-Brausebatterie 1/2 mit Brausestange und Brauseset.

Mezclador termostático externo ducha 1/2 con conjunto de ducha.

Внешний термостатический смеситель для душа с соединением 1/2" с комплектом штанги для душа.

Articolo	Note	CROMO	BO-NO-NKO	LV	BEO
8208EXWS		335,00	•	•	•

**5808SWC-S**

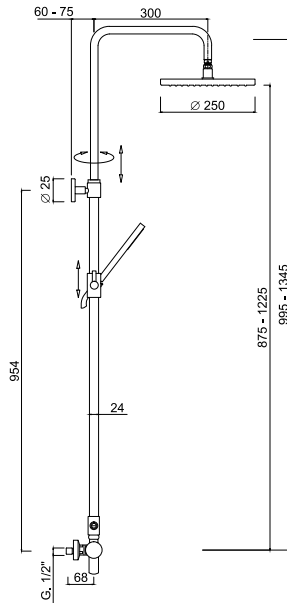

**Colonna doccia esterna monocomando, set doccia, soffione in abs**

External shower mixer with shower column, shower kit, abs shower head.

Mitigeur de douche avec colonne de douche extérieure, ensemble de douche, pomme de douche en abs.

Aufputz- Brausemischer mit Säulenbrause, Brauseset, Kopfbrause in abs.

Misturdor para ducha con columna para ducha exterior, conjunto de ducha, rociador en latón.

Однорычажный смеситель для душа внешнего монтажа с душевой колонной, душевой набор, верхний душ из латуни.

Articolo	Note	CROMO	BO-NO-NKO	LV	BEO
<b>5808SWC-S</b>		810,00	1.415,00*	840,00	1.698,00*

**8210WC-S**

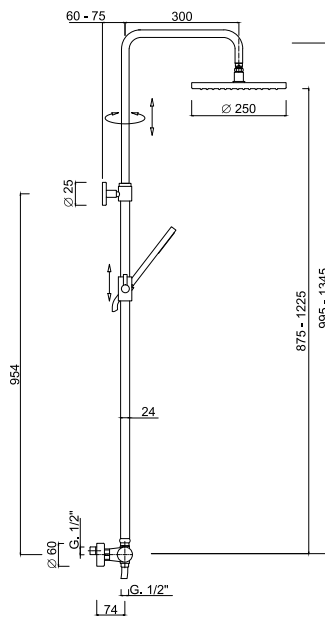

**Colonna doccia esterna termostatica, set doccia, soffione abs**

External thermostatic shower column, shower kit, abs shower head.

Colonne de douche avec mélangeur thermostatique, ensemble de douche, pomme de douche en abs.

Aufputz- Standbrause mit Thermostat-Brausebatterie, Brauseset, abs Kopfbrause.

Columna ducha con mezclador termostático, conjunto de ducha, rociador ducha abs.

Термостатическая душевая колонна внешнего монтажа, душевой набор, верхний душ ABS.

Articolo	Note	CROMO	BO-NO-NKO	LV	BEO
<b>1631</b>		830,00	•	•	•

5808

**Monocomando doccia esterno**

External single-lever shower mixer.

Mitigeur pour douche externe.

Aufputz- Einhebelbatterie.

Monomando ducha externo.

Однорычажный смеситель внешнего монтажа для душа.

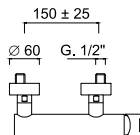
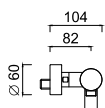

Articolo	Note	CROMO	BO-NO-KNO	LV	BEO
5808		225,00	338,00	255,00	405,00

5808S

**Monocomando doccia esterno (attacco superiore)**

External single-lever shower mixer (upper connection).

Mitigeur pour douche externe (connexion supérieure).

Aufputz- Einhebelbrausemischer (oberer Anschluss).

Monomando para ducha exterior (conexión superior).

Однорычажный смеситель для душа внешнего монтажа (подключение сверху).

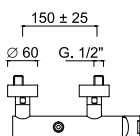
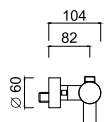

Articolo	Note	CROMO	BO-NO-KNO	LV	BEO
5808s		225,00	338,00	255,00	405,00

8208EX

**Termostatico doccia esterno attacco da 1/2"**

External thermostatic shower mixer with 1/2" connection.

Mélangeur thermostatique pour douche 1/2".

Thermostat-Brausebatterie 1/2".

Mezclador termostático externo ducha 1/2".

Внешний термостатический смеситель для душа с соединением 1/2".

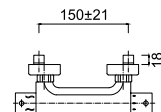
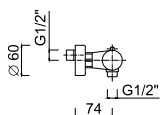

Articolo	Note	CROMO	BO-NO-NKO	LV	BEO
8208EX		255,00	•	•	•

5801

**Monocomando vasca esterno con set doccia duplex.**

External bathtub single-lever mixer with duplex shower kit.

Mitigeur bain/douche extérieur avec ensemble de douche duplex.

Aufputz- Einhebelmischer für die Badewanne mit Brauseset Duplex.

Monomando bañera externo con conjunto de ducha duplex.

Однорычажный смеситель внешнего монтажа для ванны с душевым набором "Duplex"

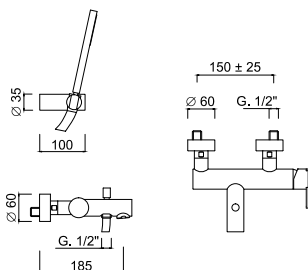

Articolo	Note	CROMO	BO-NO-NKO	LV	BEO
5801		364,00	546,00*	394,00	728,00*

**5865BD**

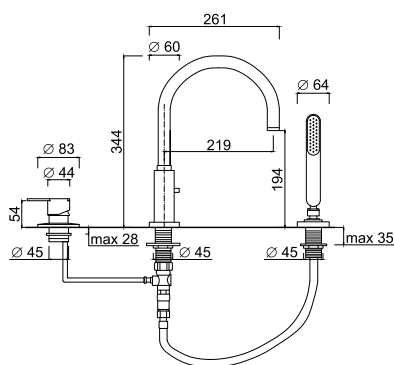

**Monocomando bordo vasca 3 fori, bocca con deviatore**  
3-hole single-lever mixer deck-mounted for bath's border, spout with diverter.  
Mélangeur à 3 trous, bec avec déviateur.  
3-Loch Wannenmischer, Auslauf mit Umstellung.  
Monomando baño sobre repisa, caño con desviación.  
Однорычажный смеситель на 3 отверстия на борт ванны, излив с дивертером.

Articolo	Note	CROMO	BO-NO-KNO	LV	BEO
5865BD		382,00	573,00*	412,00	687,00*

**5892**

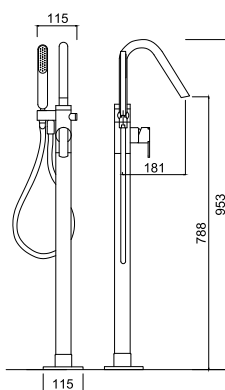

**Monocomando vasca a pavimento (con scatola incasso)**  
Free-standing bath mixer (with built-in box).  
Mélangeur baignoire à terre (avec la boîte murale).  
Wannenmischer mit Standfuss Schlauch (mit Montagedose auf dem Boden).  
Monomando bañera a pavimento (con caja de montaje en el suelo).  
Свободно-стоящий смеситель для ванны (со встраиваемой коробкой).

Articolo	Note	CROMO	BO-NO-KNO	LV	BEO
5892		1.590,00	•	1.620,00	•

**5105L**

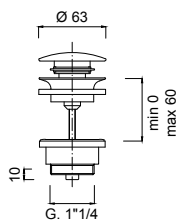

**Scarico per lavabo Up&Down 1"1/4.**  
Basin drain 1"1/4 Up&Down.  
Vidage lavabo Up&Down 1"1/4.  
Ablaufgarnitur Up&Down 1"1/4.  
Desague automatico Up&Down 1"1/4.  
Слив для раковины Up&Down 1"1/4.

Articolo	Note	CROMO	BO-NO-NKO	LV	BEO
5105L		45,00	63,00	•	81,00

**5109L**

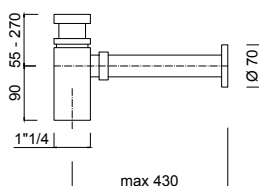

**Sifone per Lavabo 1"1/4.**  
Trap for basin 1"1/4.  
Siphon lavabo 1"1/4.  
Röhrensifon Waschtisch 1"1/4.  
Sifón para lavabo 1"1/4.  
Сифон для раковины 1"1/4.

Articolo	Note	CROMO	BO-NO-NKO	LV	BEO
5109L		90,00	135,00	•	•

3264L

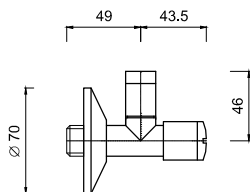

**Rubinetto sottolavabo con filterstop.**  
Under-sink valve with filterstop.  
Coude sous lavabo avec filterstop.  
Eckventile mit Filter.  
Llave de paso para lavabo con filterstop.  
Вентиль под раковину с filterstop.

Articolo	Note	CROMO	BO-NO-NKO	LV	BEO
3264L		48,00	70,00	•	87,00

1624

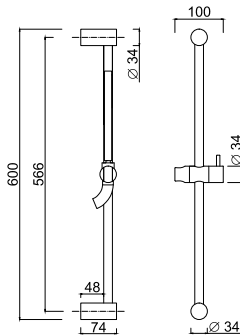

**Saliscendi con doccia Surf.**  
Sliding bar with Surf handshower.  
Barre de douche avec douchette Surf.  
Brausestange mit Handbrause Surf.  
Barra deslizando con ducha de mano Surf.  
Штанга для душа с ручным душем Surf.

Articolo	Note	CROMO	BO-NO-NKO	LV	BEO
1624		80,00	•	•	•

1510CL

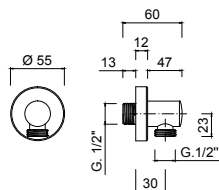

**Presca acqua 1/2".**  
Water plug 1/2".  
Prise d'eau mural 1/2".  
Wandanschlussbogen 1/2" für Brauseanschl.。  
Toma de agua 1/2".  
Крепление к стене для гибкого шланга

Articolo	Note	CROMO	BO-NO-NKO	LV	BEO
1510CL		25,00	48,00	•	50,00

## NOTE

**Potete trovare altre soluzioni per la Doccia nell'area WELLNESS.** p.374  
For additional Shower options please go to WELLNESS section.  
Pour plus de solutions pour la Douche visitez la section WELLNESS.  
Für weitere Duschalternativen sehen Sie bitte in dem Kapitel WELLNESS nach.  
Para más soluciones para Ducha visite la sección WELLNESS.  
Другие решения для Душа вы найдете в разделе Wellness.

**Per gli Accessori Bagno abbinati alla serie potete consultare la serie MODERNA.** p.446  
For matching Bathroom Fittings please check MODERNA line.  
Pour les Accessoires Salle de Bains coordonnés à la collection visitez la ligne MODERNA.  
Die zu der Serie passenden Bad-Accessoires finden Sie in dem Linie MODERNA.  
Para los Accesorios de Baño compatibles con la serie visite la línea MODERNA.  
Чтобы подобрать подходящие аксессуары для ванной комнаты, перейдите в Линия MODERNA



Pablolux









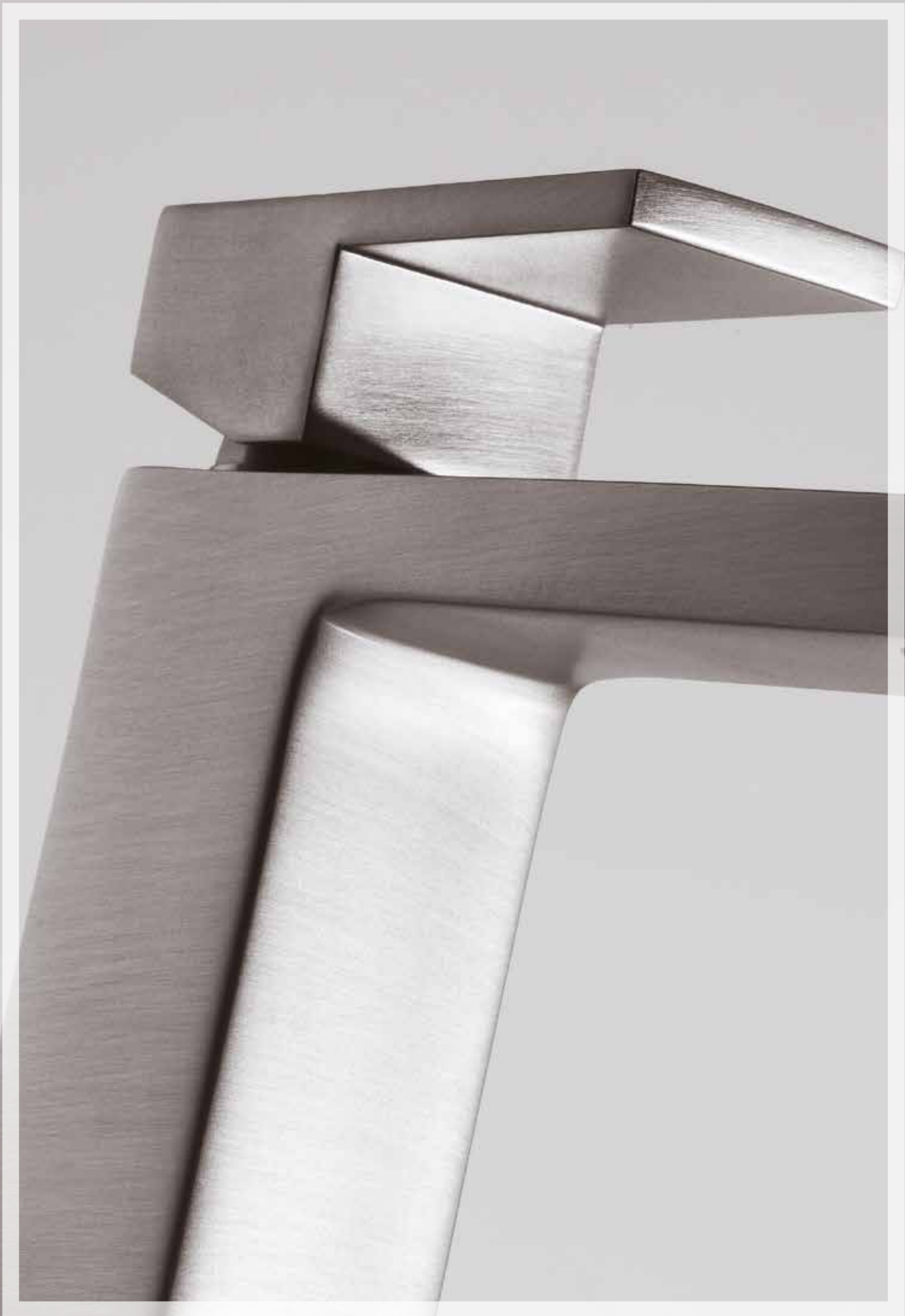



**9833A**

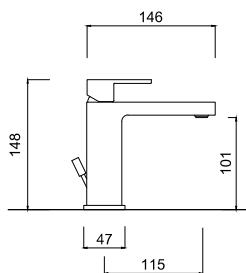

**Monocomando lavabo, scarico 1"1/4 (con flessibile).**  
Wash-basin single-lever mixer, 1"1/4 pop-up waste (with flexible).  
Mitigeur lavabo avec vidage 1"1/4 (avec flexible).  
Einhand-Waschtischbatterie mit Ablaufgarnitur 1"1/4 (mit flexiblen Anschlussschläuchen).  
Monomando lavabo tapón accionado por varilla 1"1/4 (con flexible).  
Однорычажный смеситель для раковины, донный клапан 1"1/4 (гибкая подводка).

Articolo	Note	CROMO	BO-NO-NKO	BEO	
9833A		225,00	304,00	405,00	

**9827A-B1**

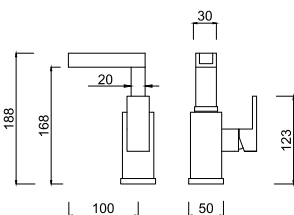

**Monocomando lavabo, bocca a cascata, scarico 1"1/4 (con flessibile).**  
Wash-basin single-lever mixer, cascade spout, 1"1/4 pop-up waste (with flexible).  
Mitigeur lavabo, bec cascade, avec vidage 1"1/4 (avec flexible).  
Einhand-Waschtischbatterie, Wasserfall-Auslauf, mit Ablaufgarnitur 1"1/4 (mit flexiblen Anschlussschläuchen).  
Monomando lavabo, caño cascada, tapón accionado por varilla 1"1/4 (con flexible).  
Однорычажный смеситель для раковины, донный клапан 1"1/4 (гибкая подводка).

Articolo	Note	CROMO	BO-NO-NKO	BEO	
9827A-B1		490,00	•	•	
9827-B1/SC	SC	477,00	•	•	

**9827A-B2**

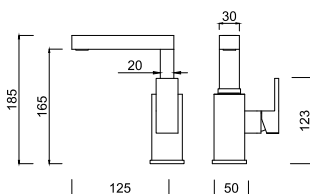

**Monocomando lavabo, scarico 1"1/4 (con flessibile)**  
Wash-basin single-lever mixer, 1"1/4 pop-up waste (with flexible).  
Mitigeur lavabo avec vidage 1"1/4 (avec flexible).  
Einhand-Waschtischbatterie mit Ablaufgarnitur 1"1/4 (mit flexiblen Anschlussschläuchen).  
Monomando lavabo tapón accionado por varilla 1"1/4 (con flexible).  
Однорычажный смеситель для раковины, донный клапан 1"1/4 (гибкая подводка).

Articolo	Note	CROMO	BO-NO-NKO	BEO	
9827A/B2		395,00	592,00	711,00	
9827-B2/SC	SC	382,00	573,00	687,00	

**9827AP**

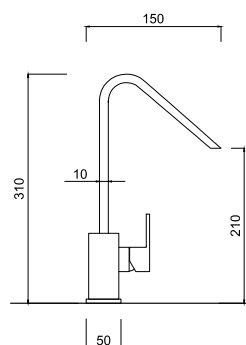

**Monocomando lavabo, canna alta piatta, scarico 1"1/4 (con flessibile)**  
Wash-basin single-lever mixer, 1"1/4 pop-up waste (with flexible).  
Mitigeur lavabo avec vidage 1"1/4 (avec flexible).  
Einhand-Waschtischbatterie mit Ablaufgarnitur 1"1/4 (mit flexiblen Anschlussschläuchen).  
Monomando lavabo tapón accionado por varilla 1"1/4 (con flexible).  
Однорычажный смеситель для раковины, донный клапан 1"1/4 (гибкая подводка).

Articolo	Note	CROMO	BO-NO-NKO	BEO	
9827AP		369,00	498,00	664,00	
9827P/SC	SC	356,00	485,00	640,00	

**9839A**

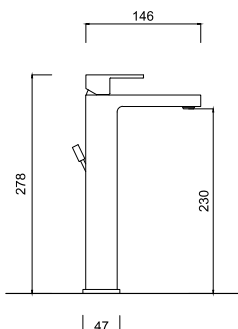

**Monocomando lavabo con prolunga, scarico 1"1/4 (con flessibile)**  
High wash-basin single-lever mixer, 1"1/4 pop-up waste (with flexible).  
Mitigeur lavabo avec bec haut et vidage 1"1/4 (avec flexible).  
Einhand-Waschtischbatterie mit hohem Auslauf und Ablaufgarnitur 1"1/4 (mit flexiblen Anschlussschläuchen).  
Monomando lavabo alto tapón accionado por varilla 1"1/4 (con flexible).  
Высокий однорычажный смеситель для раковины, донный клапан 1"1/4 (гибкая подводка).

Articolo	Note	CROMO	BO-NO-NKO	BEO	
9839A		320,00	432,00	576,00	
9839/SC	SC	307,00	419,00	552,00	

**9828A-B1**

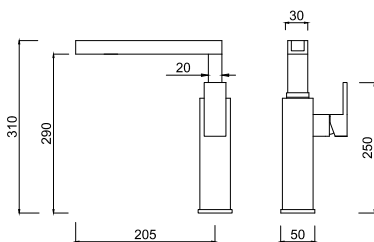

**Monocomando lavabo con prolunga, bocca lunga a cascata, scarico 1"1/4 (con flessibile)**

High wash-basin single-lever mixer, 1"1/4 pop-up waste (with flexible).  
Mitigeur lavabo avec bec haut et vidage 1"1/4 (avec flexible).  
Einhand-Waschtischbatterie mit hohem Auslauf und Ablaufgarnitur 1"1/4 (mit flexiblen Anschlussschläuchen).  
Monomando lavabo alto tapón accionado por varilla 1"1/4 (con flexible).  
Высокий однорычажный смеситель для раковины, донный клапан 1"1/4 (гибкая подводка).

Articolo	Note	CROMO	BO-NO-NKO	BEO
9828A-B1		612,00	•	•
9828-B1/SC	SC	599,00	•	•

**9828A-B2**

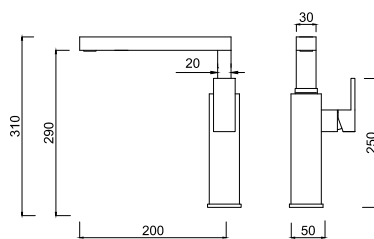

**Monocomando lavabo con prolunga, bocca lunga, scarico 1"1/4 (con flessibile)**

High wash-basin single-lever mixer with long spout, 1"1/4 pop-up waste (with flex.).  
Mitigeur lavabo haut avec bec long, avec vidage 1"1/4 (avec flexible).  
Einhand-Waschtischbatterie mit hohem und langem Auslauf, mit Ablaufgarnitur 1"1/4 Luxus (mit flexiblen Anschlussschläuchen).  
Monomando lavabo alto con caño largo, tapón accionado por varilla 1"1/4 (con flex.).  
Высокий однорычажный смеситель для раковины с удлиненным изливом, донный клапан 1"1/4 (гибкая подводка).

Articolo	Note	CROMO	BO-NO-NKO	BEO
9828A-B2		599,00	898,00	1.078,00
9828-B2/SC	SC	586,00	879,00	1.054,00

**9828AP**

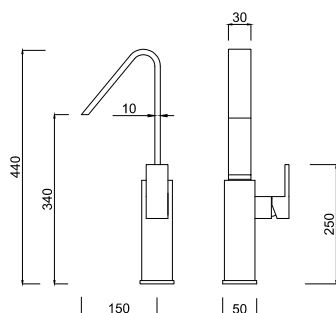

**Monocomando lavabo con prolunga, bocca piatta scarico 1"1/4 (con flessibile)**

High wash-basin single-lever mixer, luxury 1"1/4 pop-up waste (with flexible).  
Mitigeur lavabo avec bec haut et vidage 1"1/4 (avec flexible).  
Einhand-Waschtischbatterie mit hohem Auslauf und Ablaufgarnitur 1"1/4 (mit flexiblen Anschlussschläuchen).  
Monomando lavabo alto tapón accionado por varilla 1"1/4 lujo (con flexible).  
Высокий однорычажный смеситель для раковины, донный клапан 1"1/4 (гибкая подводка).

Articolo	Note	CROMO	BO-NO-NKO	BEO
9828AP		454,00	612,00	817,00
9828P/SC	SC	441,00	599,00	793,00

**9820-B1**

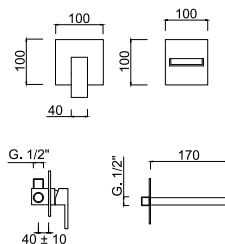

**Monocomando lavabo a muro, bocca cascata, senza scarico**

Wall-mounted wash-basin set, without pop-up waste.  
Mitigeur lavabo mural, sans vidage.  
Waschtisch- Einhebelmischer Wandmontage, ohne Ablaufgarnitur.  
Lavabo de pared, sin desagüe.  
Комплект настенного монтажа для раковины, без донного клапана

Articolo	Note	CROMO	BO-NO-NKO	BEO
9820-B1		645,00	•	•

**9820-B2**

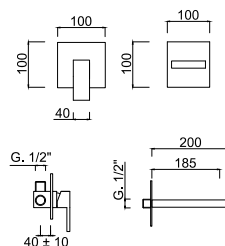

**Monocomando lavabo a muro, senza scarico**

Wall-mounted wash-basin set, without pop-up waste.  
Mitigeur lavabo mural, sans vidage.  
Waschtisch- Einhebelmischer Wandmontage, ohne Ablaufgarnitur.  
Lavabo de pared, sin desagüe.  
Комплект настенного монтажа для раковины, без донного клапана.

Articolo	Note	CROMO	BO-NO-NKO	BEO
9820-B2		480,00	720,00	864,00

**9820-B3**

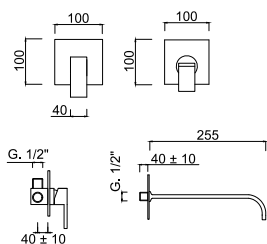

**Monocomando lavabo a muro, senza scarico**

Wall-mounted wash-basin set, without pop-up waste.

Mitigeur lavabo mural, sans vidage.

Waschtisch- Einhebelmischer Wandmontage, ohne Ablaufgarnitur.

Lavabo de pared, sin desague.

Комплект настенного монтажа для раковины, без донного клапана.

Articolo	Note	CROMO	BO-NO-NKO	BEO	
<b>9820-B3</b>		380,00	570,00	684,00	

**9809-25**

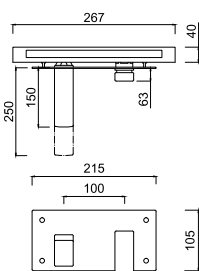

**Monocomando lavabo a muro, bocca mm 250, cornice incasso, senza scarico.**

Wall-mounted wash-basin mixer, spout mm 250, built-in framework, without pop-up waste.

Mitigeur lavabo mural, bec mm 250, gâche d'encastrement, sans vidage.

Einhebel-Waschtischmischer für die Wandmontage, Auslauf mm 250, Edelstahl-Einbaurahmen, ohne Ablaufgarnitur.

Monomando lavabo mural, caño mm 250, estructura empotrada, sin desague automatico.

Смеситель для раковины настенного монтажа, излив 250 мм, встраиваемая рамка, без донного клапана

Articolo	Note	CROMO	BO-NO-NKO	BEO	
<b>9809-25</b>	mm 250	517,00	•	•	
<b>9809-15</b>	mm 150	517,00	•	•	

**9809-B1**

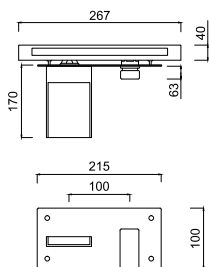

**Monocomando lavabo a muro, bocca cascata, cornice incasso, senza scarico.**

Wall-mounted wash-basin mixer, cascade spout, built-in framework, without pop-up waste.

Mitigeur lavabo mural, bec cascade, gâche d'encastrement, sans vidage.

Einhebel-Waschtischmischer für die Wandmontage, Wasserfall-Auslauf, Edelstahl-Einbaurahmen, ohne Ablaufgarnitur.

Monomando lavabo mural, caño cascada, estructura empotrada, sin desague automatico.

Смеситель для раковины настенного монтажа, каскадный излив, встраиваемая рамка, без донного клапана

Articolo	Note	CROMO	BO-NO-NKO	BEO	
<b>9809-B1</b>		720,00	•	•	

**9810**

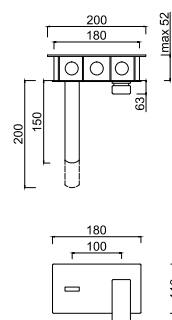

**Monocomando lavabo a muro, bocca mm 200, box incasso, senza scarico.**

Wall-mounted wash-basin mixer, spout mm 200, built-in box, without pop-up waste.

Mitigeur lavabo mural, bec mm 200, box d'encastrement, sans vidage.

Einhebel-Waschtischmischer für die Wandmontage, Auslauf mm 200, Einbau-Box, ohne Ablaufgarnitur.

Monomando lavabo mural, caño mm 200, box empotrado incluido, sin desague automatico.

Смеситель для раковины настенного монтажа, излив 200 мм, встраиваемый бокс, без донного клапана

Articolo	Note	CROMO	BO-NO-NKO	BEO	
<b>9810</b>	mm 200	395,00	•	•	
<b>9810-15</b>	mm 150	395,00	•	•	

**9890**

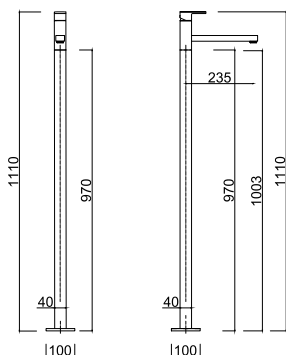

**Monocomando lavabo a pavimento**

Wash-basin single-lever mixer with floor pillar leg.

Mitigeur lavabo avec colonnette alimentation par le sol.

Waschtisch- Einhebelmischer mit Standfuss.

Monomando lavabo con toma de agua a suelo.

Однорычажный смеситель для раковины с напольной колонной.

Articolo	Note	CROMO	BO-NO-NKO	BEO	
<b>9890</b>		1.610,00	2.174,00	•	



9835A-15

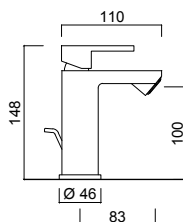

**Monocomando bidet, scarico 1"1/4 (con flessibile).**  
Bidet single-lever mixer, 1"1/4 pop-up waste (with flexible).  
Mitigeur bidet avec vidage 1"1/4 (avec flexible).  
Einhand-Bidetbatterie mit Ablaufgarnitur 1"1/4 (mit flexiblen Anschlusschläuchen).  
Monomando bidet, tapón accionado por varilla 1"1/4 (con flexible).  
Однорычажный смеситель для биде, донный клапан 1"1/4 (гибкая подводка).

Articolo	Note	CROMO	BO-NO-NKO	BEO
9838A-15		225,00	304,00	405,00

9829AP

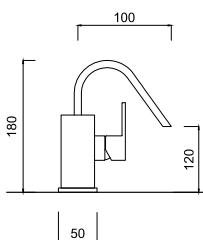

**Monocomando bidet, bocca piatta, scarico 1"1/4 (con flessibile).**  
Bidet single-lever mixer, 1"1/4 pop-up waste (with flexible).  
Mitigeur bidet avec vidage 1"1/4 (avec flexible).  
Einhand-Bidetbatterie mit Ablaufgarnitur 1"1/4 (mit flexiblen Anschlusschläuchen).  
Monomando bidet, tapón accionado por varilla 1"1/4 (con flexible).  
Однорычажный смеситель для биде, донный клапан 1"1/4 (гибкая подводка).

Articolo	Note	CROMO	BO-NO-NKO	BEO
9829AP		369,00	498,00	664,00

9829A-B1

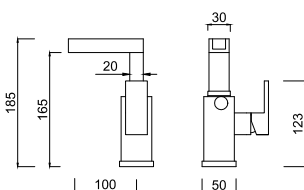

**Monocomando bidet, bocca cascata, scarico 1"1/4 (con flessibile).**  
Bidet single-lever mixer, 1"1/4 pop-up waste (with flexible).  
Mitigeur bidet avec vidage 1"1/4 (avec flexible).  
Einhand-Bidetbatterie mit Ablaufgarnitur 1"1/4 (mit flexiblen Anschlusschläuchen).  
Monomando bidet, tapón accionado por varilla 1"1/4 (con flexible).  
Однорычажный смеситель для биде, донный клапан 1"1/4 (гибкая подводка).

Articolo	Note	CROMO	BO-NO-NKO	BEO
9829A-B1		490,00	•	•

9829A-B2

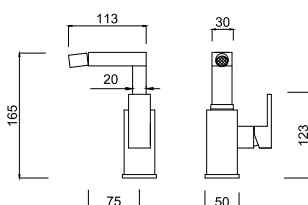
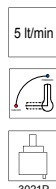

**Monocomando bidet, scarico 1"1/4 (con flessibile).**  
Bidet single-lever mixer, 1"1/4 pop-up waste (with flexible).  
Mitigeur bidet avec vidage 1"1/4 (avec flexible).  
Einhand-Bidetbatterie mit Ablaufgarnitur 1"1/4 (mit flexiblen Anschlusschläuchen).  
Monomando bidet, tapón accionado por varilla 1"1/4 (con flexible).  
Однорычажный смеситель для биде, донный клапан 1"1/4 (гибкая подводка).

Articolo	Note	CROMO	BO-NO-NKO	BEO
9829A-B2		395,00	592,00	711,00

SH20/P

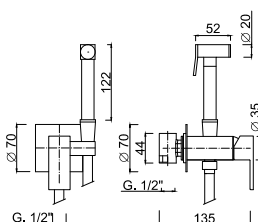

**Miscelatore monocomando incasso per bidet**  
Built-in single-lever mixer for bidet  
Mitigeur à encastrer pour bidet  
UP-Einhebelmischer für Bidet  
Monomando empotrado para bidé  
Однорычажный встраиваемый смеситель для биде.

Articolo	Note	CROMO	BO-NO-NKO	BEO
SH20/P		183,00	•	•



### 9815WB-25

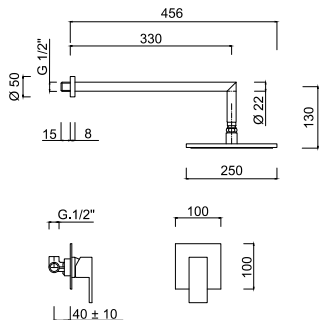

#### Set doccia incasso monocomando, soffione ottone

Shower built-in single-lever mixer, brass shower head.  
Mitigeur pour douche à encaissement, pomme de douche en laiton.  
Unterputz-Duscheneinhebelmischer, Kopfbrause in Messing.  
Monomando ducha para empotrar, rociador en latón.  
Однорычажный встроенный смеситель для душа, верхний душ из латуни.

Articolo	Note	CROMO	BO-NO-NKO	BEO
9815WB-25		525,00	732,00	945,00

### 9815WSQ

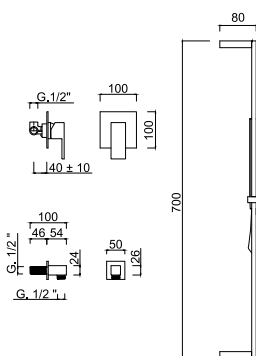

#### Set doccia incasso monocomando, saliscendi, presa acqua.

Built-in shower mixer with sliding rail and water plug.  
Mitigeur douche à encastrer avec barre de douche et prise d'eau.  
UP-Einhebel-Brausemischer mit Brausestange, Brauseset und Wandanschlussbogen.  
Kit de ducha empotrado con barra deslizante y toma de agua.  
Встраиваемый смеситель для душа с регулируемой штангой и разъемом для подачи воды

Articolo	Note	CROMO	BO-NO-NKO	BEO
9815WSQ		385,00	713,00	850,00

### 9815WC-SQ

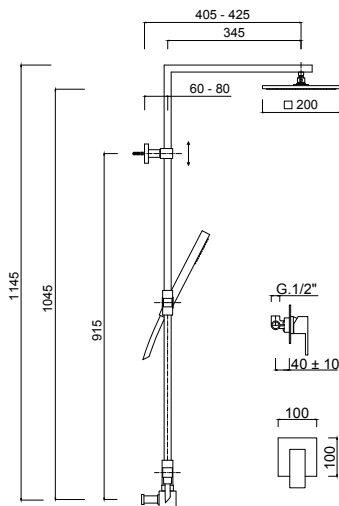
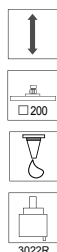

#### Set doccia incasso monocomando, supporto presa/acqua, colonna doccia con soffione ottone.

Built-in shower mixer with holder/water plug, shower column and brass showerhead.  
Mitigeur douche à encastrer avec support/prise d'eau, colonne de douche et douche de tête en laiton.  
UP-Einhebel-Brausemischer, Brausehalter/Wandanschlussbogen, Duschsäule mit Kopfbrause aus Messing.  
Conjunto monomando ducha empotrado, soporte/toma de agua, rociador en latón.  
Встраиваемый смеситель для душа с держателем/разъемом для подачи воды, душевой колонной и верхним душем из латуни

Articolo	Note	CROMO	BO-NO-NKO	BEO
9815WC-SQ		930,00	•	•

### 9813KB-25

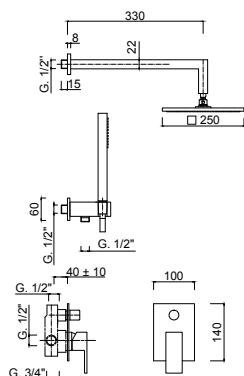

#### Set doccia incasso monocomando con deviatore, soffione ottone, kit duplex incasso

Shower built-in single-lever mixer with diverter, brass shower head, built-in duplex shower kit.  
Mitigeur pour douche à encaissement avec inverseur, pomme de douche en laiton, ensemble de douche duplex à encaissement.  
Unterputz-Duscheneinhebelmischer mit Umstellung, Brausekopf in Messing, Einbau-Brauseset Duplex.  
Monomando ducha para empotrar con desviador, rociador ducha en latón, conjunto ducha duplex para empotrar.  
Однорычажный встроенный смеситель для душа с дивертером, верхний душ из латуни, встроенный душевой набор "Duplex".

Articolo	Note	CROMO	BO-NO-NKO	BEO
9813KB-25		730,00	1.081,00	1.314,00

**9813-3KS2**

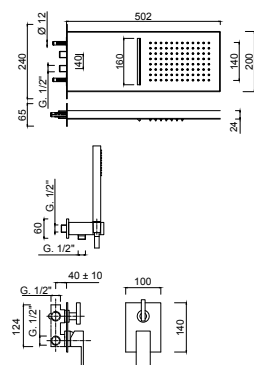

**Set doccia incasso monocomando con deviatore 3 vie, set doccia incasso, soffione cascata/pioggia.**

*Built-in shower mixer with 3-way diverter, built-in shower kit, waterfall/rainfall showerhead.*

*Mitigeur douche à encastrer avec inverseur à 3 sorties, ensemble de douche à encastrer, douche de tête avec jets cascade et pluie.*

*UP-Einhebel-Brausemischer mit 3-Wege-Umstellung, Unterputz-Brauseset, Kopfbrause mit Wasserfall/Regenstrahl.*

*Conjunto monomando ducha empotrado con inversor 3 vias, kit de ducha empotrado, rociador cascada/lluvia.*

*Встраиваемый смеситель для душа с дивертером на 3 выхода, встраиваемым душевым набором, верхним душем с функциями каскада и дождя*

Articolo	Note	CROMO	BO-NO-NKO	BEO	
9813-3KS2		1.139,00	•	•	

**9815**

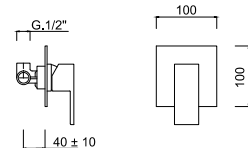

**Monocomando doccia incasso.**

*Shower built-in single-lever mixer.*

*Mitigeur pour douche à encaissement.*

*Unterputz-Duscheneinhebelmischer.*

*Monomando ducha para empotrar.*

*Однорычажный встроенный смеситель для душа.*

Articolo	Note	CROMO	BO-NO-NKO	BEO	
9815		145,00	196,00	261,00	

**9813**

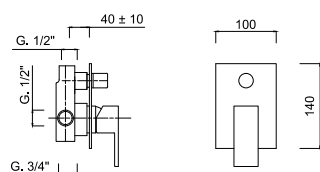

**Monocomando doccia incasso con deviatore**

*Shower built-in single-lever mixer with diverter.*

*Mitigeur pour douche à encaissement avec inverseur.*

*Unterputz-Duscheneinhebelmischer mit Umstellung.*

*Monomando ducha para empotrar con desviador.*

*Однорычажный встроенный смеситель для душа с дивертером.*

Articolo	Note	CROMO	BO-NO-NKO	BEO	
9813		248,00	335,00	446,00	

**9813-3**

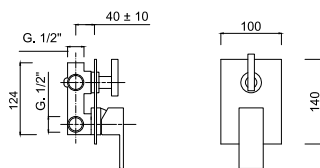
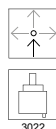

**Monocomando doccia incasso con deviatore 3 uscite**

*Shower built-in single-lever mixer with 3 outlets diverter.*

*Mitigeur pour douche à encaissement avec inverseur à 3 sorties.*

*Unterputz-Duscheneinhebelmischer mit 3-Augänge Umstellung.*

*Monomando ducha para empotrar con desviador a 3 salidas.*

*Однорычажный встроенный смеситель для душа с дивертером на 3 выхода.*

Articolo	Note	CROMO	BO-NO-NKO	BEO	
9813-3		340,00	510,00	612,00	

**9813-4**

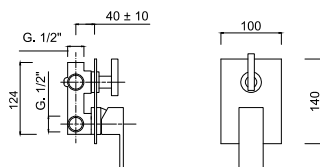
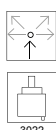

**Monocomando doccia incasso con deviatore 4 uscite**

*Shower built-in single-lever mixer with 4 outlets diverter.*

*Mitigeur pour douche à encaissement avec inverseur à 4 sorties.*

*Unterputz-Duscheneinhebelmischer mit 4-Augänge Umstellung.*

*Monomando ducha para empotrar con desviador a 4 salidas.*

*Однорычажный встроенный смеситель для душа с дивертером на 4 выхода.*

Articolo	Note	CROMO	BO-NO-NKO	BEO	
9813-4		357,00	534,00	640,00	

9869

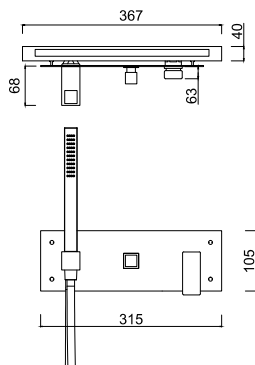
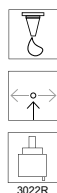

**Monocomando doccia incasso, set doccia, 1 uscita libera, cornice incasso.**

*Built-in shower mixer, integrated shower set + 1 additional water outlet, built-in framework.*

*Mitigeur douche à encastrer, ensemble de douche intégrée + 1 sortie supplémentaire disponible, gâche d'encastrement.*

*UP-Einhebel-Brausemischer, integrierte Brauseset + 1 zusätzlicher Verbraucher, Edelstahl-Einbaurahmen.*

*Monomando ducha empotrado, kit de ducha, 1 salida adicional disponible, estructura empotrada.*

*Встраиваемый смеситель для душа, встраиваемый душевой набор + 2 дополнительных выхода воды, встраиваемая рамка*

Articolo	Note	CROMO	BO-NO-NKO	BEO
9869		980,00	•	•

8212-PB

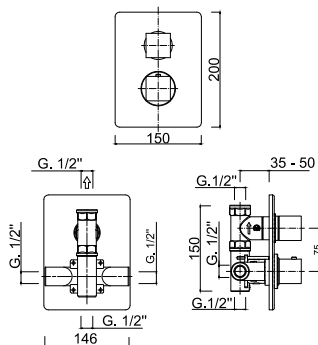

**Termostatico incasso 1/2", con rubinetto d'arresto 1/2".**

*Built-in thermostatic mixer 1/2", with built-in tap 1/2".*

*Mitigeur thermostatique mural, 1/2", avec robinet mural 1/2".*

*Eingebaute Einhebel Thermostatbatterie 1/2", mit Ventil 1/2".*

*Mezclador termostatico a empotrar 1/2", con grifo 1/2".*

*Встраиваемый термостат 1/2" со встраиваемым смесителем 3/4".*

Articolo	Note	CROMO	BO-NO-NKO	BEO
8212-PB		440,00	594,00	•

8213-PB

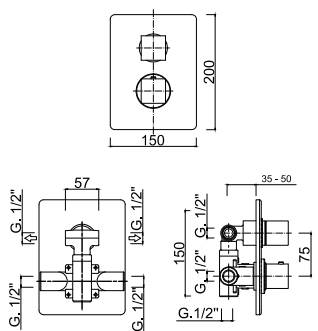

**Termostatico incasso 2 uscite**

*2 outlets built-in thermostatic mixer*

*Mitigeur thermostatique mural à 2 sorties*

*2-Ausgänge eingebaute Einhebel-Thermostatbatterie*

*Mezclador termostatico a empotrar a 2 salidas.*

*Встроенный термостатический смеситель на 2 выхода*

Articolo	Note	CROMO	BO-NO-NKO	BEO
8213-PB		490,00	662,00	•

8270

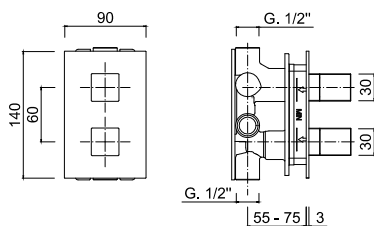
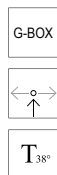
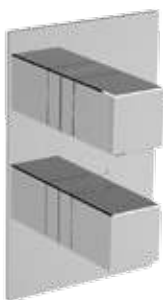

**Termostatico incasso 2 uscite, box incasso.**

*Built-in thermostatic mixer with 2 outlets, built-in box.*

*Mitigeur thermostatique douche à encastrer avec 2 sorties, box d'encastrement.*

*UP-Thermostat mit 2-Wege-Umstellung, inkl. Box.*

*Termostática empotrada 2 salidas, box empotrado incluido.*

*Встраиваемый термостатический смеситель с 2 выходами, встраиваемый бокс*

Articolo	Note	CROMO	BO-NO-NKO	BEO
8270		825,00	1.114,00	•

8271

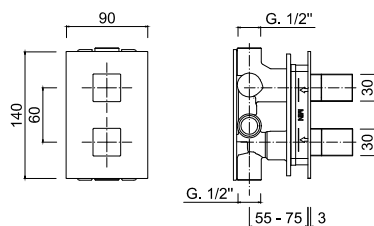
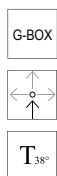
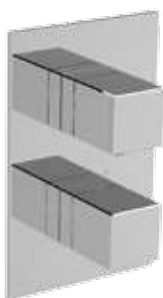

**Termostatico incasso 3 uscite, box incasso.**

*Built-in thermostatic mixer with 3 outlets, built-in box.*

*Mitigeur thermostatique douche à encastrer avec 3 sorties, box d'encastrement.*

*UP-Thermostat mit 3-Wege-Umstellung, inkl. Box.*

*Termostática empotrada 3 salidas, box empotrado incluido.*

*Встраиваемый термостатический смеситель с 3 выходами, встраиваемый бокс*

Articolo	Note	CROMO	BO-NO-NKO	BEO
8271		895,00	1.209,00	•

8272

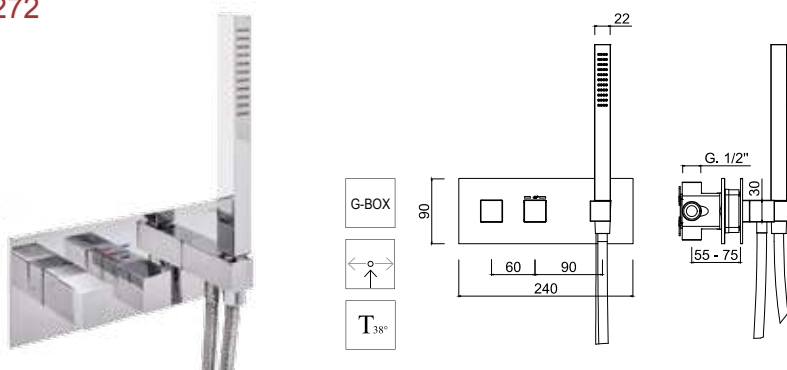

**termostatico incasso, set doccia, 1 uscita libera, box incasso.**  
Built-in thermostatic mixer, integrated shower set + 1 additional water outlet, built-in box.

Mitigeur thermostatique douche à encastrer, ensemble de douche + 1 sortie supplémentaire disponible, box d'encastrement.

UP-Thermostat, integrierte Brauseset + 1 zusätzlicher Verbraucher, inkl. Box.

Termostática empotrada, kit de ducha, 1 salida adicional disponible, box empotrado incluido.

Встраиваемый термостатический смеситель, интегрированный душевой комплект + дополнительный выход воды, встраиваемый бокс

Articolo	Note	CROMO	BO-NO-NKO	BEO	
8272		1.050,00	1.418,00	•	

8273

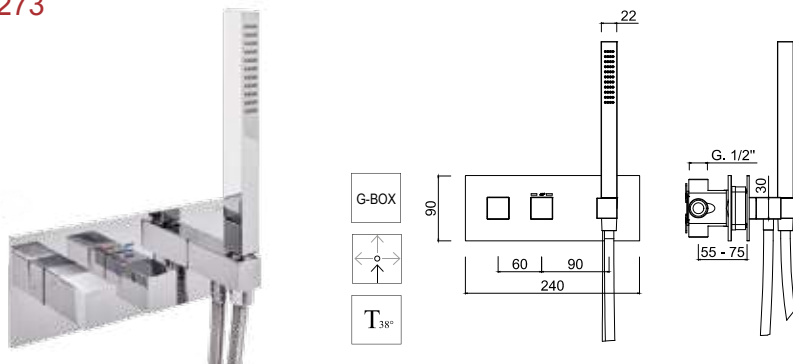

**termostatico incasso, set doccia, 2 uscite libere, box incasso.**

Built-in thermostatic mixer, integrated shower set + 2 additional water outlets, built-in box.

Mitigeur thermostatique douche à encastrer, ensemble de douche + 2 sorties supplémentaires disponibles, box d'encastrement.

UP-Thermostat, integrierte Brauseset + 2 zusätzliche Verbraucher, inkl. Box.

Termostática empotrada, kit de ducha, 2 salidas adicionales disponibles, box empotrado incluido.

Встраиваемый термостатический смеситель, интегрированный душевой комплект + 2 дополнительных выхода воды, встраиваемый бокс

Articolo	Note	CROMO	BO-NO-NKO	BEO	
8273		1.110,00	1.499,00	•	

1701-20

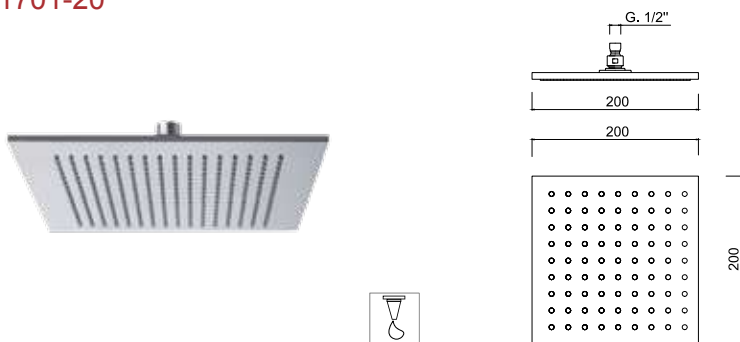

**Soffione doccia anticalcare □ 200. Ottone**

Shower head, anti limestone, □ 200 mm. In brass.

Pomme de douche anticalcaire □ 200 mm. En laiton.

Kopfbrause, Antikalk System, □ 200 mm. In Messing.

Rociador antical □ 200 mm, en latón.

Верхний душ, защита от известняка, □ 200 мм, латунь

Articolo	Note	CROMO	BO-NO-NKO	BEO	
1701-20	mm 200	182,00	•	•	
1701-25	mm 250	297,00	430,00	534,00	
1701-30	mm 300	358,00	•	•	

1704-20



**Soffione doccia anticalcare □ 200. Inox**

200 mm diameter shower head, anti limestone. Stainless steel.

Pomme de douche anticalcaire □ 200 mm. Inox.

Kopfbrause, Antikalk System □ 200 mm. Inox.

Rociador antical □ 200 mm. Inoxidable.

Верхний душ □ 200 мм, защита от известняка, нержавеющая сталь.

Articolo	Note	CROMO	BO-NO-NKO	BEO	
1704-20	mm 200	121,00	•	•	
1704-25	mm 250	176,00	•	•	
1704-30	mm 300	231,00	•	•	
1704-40	mm 400	363,00	•	•	

1745-33

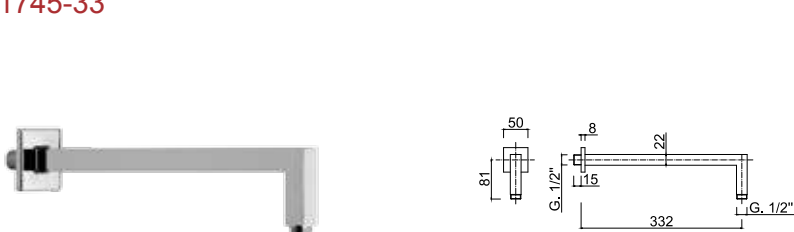

**Braccio doccia in ottone da mm 330.**

Brass shower arm, length mm 330.

Bras de douche, laiton chromé, longueur mm 330.

Wandarm, mm 330 Länge, verchromtes Messing.

Brazo ducha largo 330 mm, latón cromado.

Душевой кронштейн из латуни, длина 330 мм.

Articolo	Note	CROMO	BO-NO-NKO	BEO	
1745-33	mm 330	116,00	160,00	209,00	
1745-40	mm 400	120,00	•	•	

1760-20

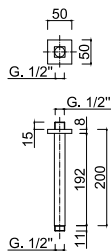

**Braccio doccia da soffitto mm.200.**

Ceiling shower arm mm 200.  
Bras de douche vertical mm 200.  
Brausearm für Deckenmontage mm 200.  
Braço de ducha a techo mm 200.  
Держатель душа 200 мм, потолочный

Articolo	Note	CROMO	BO-NO-NKO	BEO	
1760-20	mm 200	71,00	116,00	145,00	
1760-30	mm 300	75,00	•	•	

1721-A

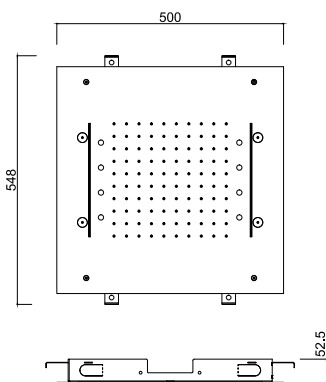

**Soffione inox incasso □ 500, con getto pioggia, 4 nebulizzatori, 2 cascate, sistema di cromoterapia 7 colori con comando remoto touch wireless.**

Stainless steel built-in showerhead □ 500, with rainfall jet, 4 spray jets, 2 waterfall jets and 7-colours LED lights for chromotherapy with touch screen wireless remote-control.  
Ciel de pluie à encastrer au plafond en acier inox □ 500 avec jet à pluie, 4 jets latéraux d'eau brumisée, 2 cascades, LED pour la chromothérapie en 7 couleurs avec télécommande à l'écran tactile sans fils.  
Kopfbrause Inox □ 500 für Deckenmontage mit Regendusche, 4 Körperbrausen, 2 Wasserfällen, LED Farbtherapie in 7 Farben mit Touch Screen kabelloser Fernbedienung.  
Rociador de techo empotrado inox □ 500 con chorro lluvia, 4 jets de agua pulverizada, 2 cascadas, LED luz cromoterapia en 7 colores con control remoto touch screen sin cables.  
Встраиваемый верхний душ Ø 500 из нержавеющей стали с функцией дождя, 4 распылительными форсунками, 2 каскадами, функцией хромотерапии с 7 LED цветами, регулируемая посредством дистанционного сенсорного пульта

Articolo	Note	CROMO	BO-NO-NKO	BEO	
1721-A		2.550,00	•	•	

1721-B

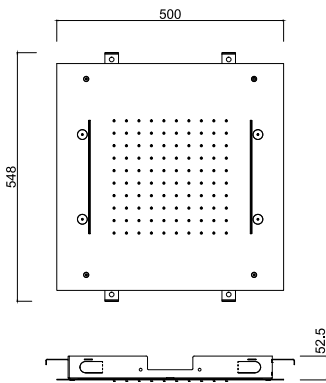

**Soffione inox incasso □ 500, con getto pioggia, 4 nebulizzatori, 2 cascate.**

Stainless steel built-in showerhead □ 500, with rainfall jet, 4 spray jets, 2 waterfall jets.  
Ciel de pluie à encastrer au plafond en acier inox □ 500 avec jet à pluie, 4 jets latéraux d'eau brumisée, 2 cascades.  
Kopfbrause Inox Ø 500 für Deckenmontage mit Regendusche, 4 Körperbrausen, 2 Wasserfällen.  
Rociador de techo empotrado inox □ 500 con chorro lluvia, 4 jets de agua pulverizada, 2 cascadas.  
Встраиваемый верхний душ Ø 500 из нержавеющей стали, с функцией дождя, 4 распылительными форсунками, 2 каскадами

Articolo	Note	CROMO	BO-NO-NKO	BEO	
1721-B		1.795,00	•	•	

1725-50

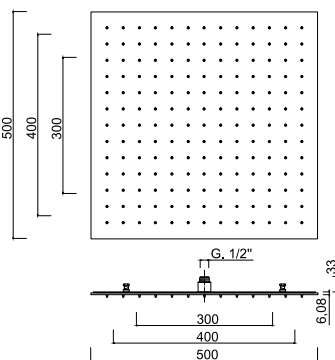

**Soffione inox incasso 500x500, con getto pioggia.**

Ceiling-mounted stainless steel shower head 500x500, with rainfall jet.  
Ciel de pluie à encastrer au plafond en acier inox 500x500 avec jet à pluie.  
Kopfbrause Inox für Deckeneinbau 500x500, mit Regenstrahl.  
Rociador Inox de techo empotrado 500x500, con chorro lluvia.  
Верхний душ 500x500 из нержавеющей стали с функцией дождя.

Articolo	Note	CROMO	BO-NO-NKO	BEO	
1725-50	mm 500	1.250,00	1.650,00	1.733,00	
1725-40	mm 400	1.040,00	1.381,00	1.458,00	
1725-30	mm 300	780,00	1.084,00	1.166,00	

1733-20

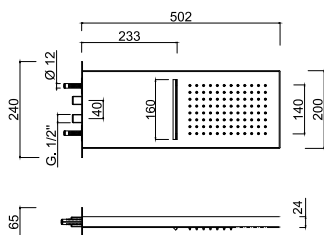

**Soffione a parete, getto pioggia, getto cascata.**

Wall-mounted showerhead with rainfall and waterfall jets.

Douche de tête mural avec jet pluie et cascade.

Kopfbrause für Wandmontage mit Regen- und Wasserfalldusche.

Rociador ducha a pared, chorro lluvia, cascada.

Верхний душ настенного монтажа с функциями дождя и водопада

Articolo	Note	CROMO	BO-NO-NKO	BEO	
1733-20		769,00	•	•	

1734-20

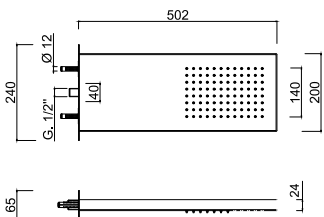

**Soffione a parete, getto pioggia.**

Wall-mounted showerhead with rainfall jet.

Douche de tête mural avec jet pluie.

Kopfbrause für Wandmontage mit Regendusche.

Rociador ducha a pared, chorro lluvia.

Верхний душ настенного монтажа с функцией дождя

Articolo	Note	CROMO	BO-NO-NKO	BEO	
1734-20		577,00	•	•	

1739

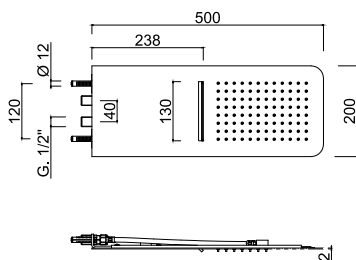

**Soffione a parete, getto pioggia, getto cascata.**

Wall-mounted showerhead with rainfall and waterfall jets.

Douche de tête mural avec jet pluie et cascade.

Kopfbrause für Wandmontage mit Regen- und Wasserfalldusche.

Rociador ducha a pared, chorro lluvia, cascada.

Верхний душ настенного монтажа с функциями дождя и водопада

Articolo	Note	CROMO	BO-NO-NKO	BEO	
1739		595,00	•	•	

1740

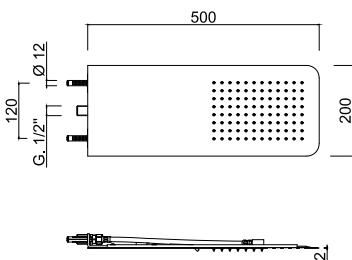

**Soffione a parete, getto pioggia.**

Wall-mounted showerhead with rainfall jet.

Douche de tête mural avec jet pluie.

Kopfbrause für Wandmontage mit Regendusche.

Rociador ducha a pared, chorro lluvia.

Верхний душ настенного монтажа с функцией дождя

Articolo	Note	CROMO	BO-NO-NKO	BEO	
1740		450,00	•	•	

1743-A

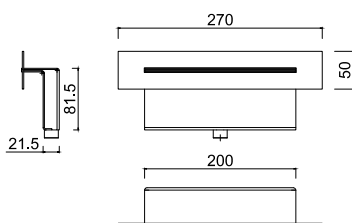

**Bocca incasso, getto cascata.**

Built-in waterfall spout.

Bec à encastrer avec jet cascade.

UP-Wasserfall-Auslauf.

Caño empotrado, chorro cascada.

Встраиваемый каскадный излив

Articolo	Note	CROMO	BO-NO-NKO	BEO	
1743-A		461,00	•	•	





1540

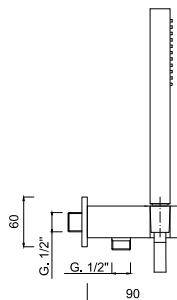

**Kit duplex incasso Pablolux.**

Built-in duplex shower kit Pablolux.  
Ensemble de douche duplex à encaissement Pablolux.  
Einbaubrauseset Duplex Pablolux.  
Conjunto de ducha duplex para empotrar Pablolux.  
встроенный душевой набор "Duplex" Pablolux.

Articolo	Note	CROMO	BO-NO-NKO	BEO	
1540		104,00	225,00	250,00	

9808-12WSQ



3022

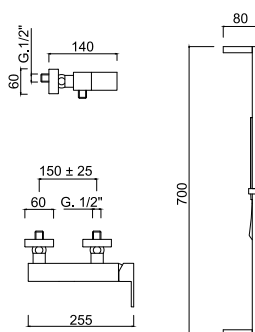

**Monocomando doccia esterno con saliscendi e doccia.**

External single-lever shower mixer with sliding rail set.  
Mitigeur extérieur de douche avec barre coulissante et ensemble de douche.  
Aufputz- Einhand-Brausebatterie mit Brausestange und Brauseset.  
Monomando ducha exterior con conjunto de ducha.  
Однорычажный смеситель внешнего монтажа для душа с комплектом штанги для душа.

Articolo	Note	CROMO	BO-NO-NKO	BEO	
9808-12WSQ		489,00	836,00	950,00	

9808WC-SQ



3022

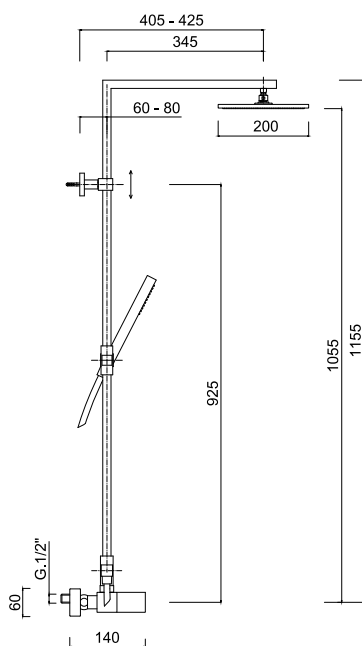

**Colonna doccia esterna monocomando, set doccia, soffione in ottone**

External single-lever shower mixer with shower column, shower kit, brass shower head.  
Mitigeur de douche avec colonne de douche, ensemble de douche, pomme de douche en laiton.  
Brausemischer mit Säulenbrause, Brauseset, Kopfbrause in Messing.  
Monomando con columna para ducha, conjunto de ducha, rociador en latón.  
Однорычажный смеситель для душа внешнего монтажа с душевой колонной, душевой набор, верхний душ из латуни.

Articolo	Note	CROMO	BO-NO-NKO	BEO	
9808WC-SQ		1.074,00	•	•	

8300-20

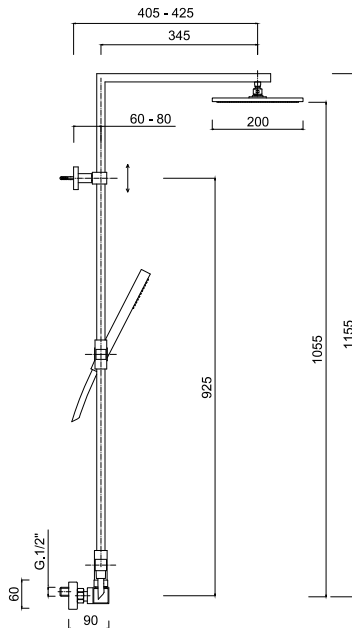

**Colonna doccia esterna termostatica, set doccia, soffione in ottone**

External thermostatic shower column, shower kit, brass shower head  
Colonne de douche avec mitigeur thermostatique, ensemble de douche, pomme de douche en laiton  
Aufputz- Standbrause mit Thermostat-Brausebatterie, Brauseset, Kopfbrause in Messing  
Columna ducha con mezclador termostático, conjunto de ducha, rociador ducha en latón  
Термостатическая душевая колонна внешнего монтажа, душевой набор, верхний душ из латуни

Articolo	Note	CROMO	BO-NO-NKO	BEO	
8300-20		1.073,00	•	•	

8301-20

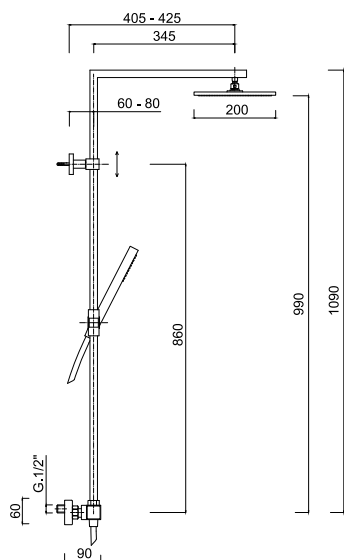
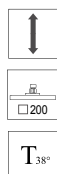

**Colonna doccia esterna termostatica, set doccia, soffione in ottone**

External thermostatic shower column, shower kit, brass shower head  
Colonne de douche avec mitigeur thermostatique, ensemble de douche, pomme de douche en laiton  
Aufputz- Standbrause mit Thermostat-Brausebatterie, Brauseset, Kopfbrause in Messing  
Columna ducha con mezclador termostático, conjunto de ducha, rociador ducha en latón  
Термостатическая душевая колонна внешнего монтажа, душевой набор, верхний душ из латуни

Articolo	Note	CROMO	BO-NO-NKO	BEO	
8301-20		1.029,00	•	•	

**9808-12**

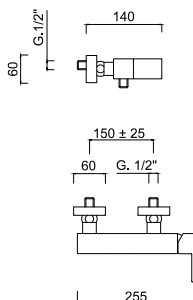

**Monocomando doccia esterno**  
External single-lever shower mixer.  
Mitigeur pour douche externe.  
Aufputz-Einhebelbatterie.  
Monomando ducha externo.

Однорычажный смеситель внешнего монтажа для душа.

Articolo	Note	CROMO	BO-NO-NKO	BEO	
9808-12		295,00	399,00	531,00	

**9808S**

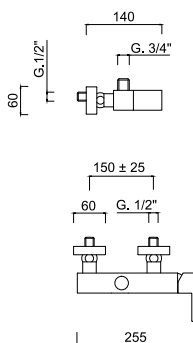

**Monocomando doccia esterno (attacco superiore)**  
External single-lever shower mixer (upper connection).  
Mitigeur douche (connection supérieure).  
Aufputz- Brausemischer (oberer Anschluss).  
Misturador para ducha (conexión superior).  
Однорычажный смеситель для душа внешнего монтажа (подключение сверху)

Articolo	Note	CROMO	BO-NO-NKO	BEO	
9808S		295,00	399,00	531,00	

**8203**

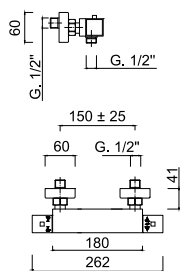

**Termostatico doccia esterno attacco da 1/2**  
External thermostatic shower mixer with 1/2 connection.  
Mitigeur thermostatique pour douche 1/2.  
Thermostat-Brausebatterie 1/2.  
Mezclador termostático externo ducha 1/2.  
Термостатический смеситель внешнего монтажа с соединением 1/2"

Articolo	Note	CROMO	BO-NO-NKO	BEO	
8203		260,00	•	•	

**8204**

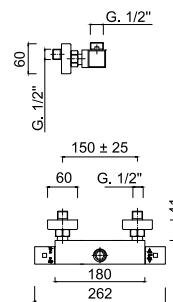

**Termostatico doccia esterno attacco superiore da 3/4"**  
Wall-mounted thermostatic shower mixer with 3/4" upper connection.  
Mitigeur thermostatique douche avec raccord supérieur 3/4".  
AP-Thermostat mit Anschluss oben 3/4".  
Termostática ducha de superficie con ataco superior 3/4".  
Термостатический смеситель для душа настенного монтажа с верхним подключением на 3/4"

Articolo	Note	CROMO	BO-NO-NKO	BEO	
8204		260,00	•	•	

**8205**

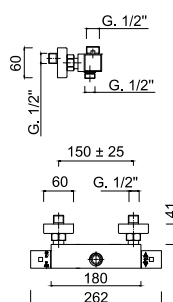

**Termostatico doccia esterno con deviatore incorporato, attacco superiore da 3/4", inferiore da 1/2"**  
Wall-mounted thermostatic shower mixer with integrated diverter, 3/4" upper connection, 1/2" lower connection.  
Mitigeur thermostatique douche avec inverseur intégré, raccord supérieur 3/4" et raccord inférieur 1/2".  
AP-Thermostat mit integriertem Umsteller, Anschlüsse oben 3/4" und unten 1/2".  
Termostática ducha de superficie con inversor integrado, ataco superior 3/4" y inferior 1/2".  
Термостатический смеситель для душа настенного монтажа с интегрированным дивертером, верхним подключением на 3/4", нижним подключением на 1/2"

Articolo	Note	CROMO	BO-NO-NKO	BEO	
8205		280,00	•	•	

9801-12

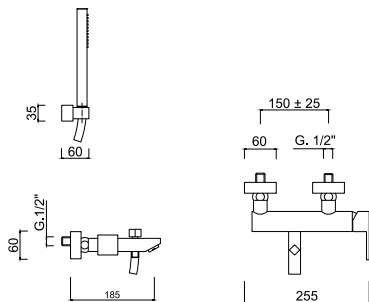

**Monocomando vasca esterno con set doccia duplex.**  
External bathtub single-lever mixer with duplex shower kit.  
Mitigeur bain/douche mural avec ensemble de douche duplex.  
Aufputz- Einhebelmischer mit Brauseset Duplex.  
Monomando bañera externo con conjunto de ducha duplex.  
Однорычажный смеситель внешнего монтажа для ванны с душевым набором "Duplex".

Articolo	Note	CROMO	BO-NO-NKO	BEO
9801-12		398,00	597,00*	717,00*

9861-B1

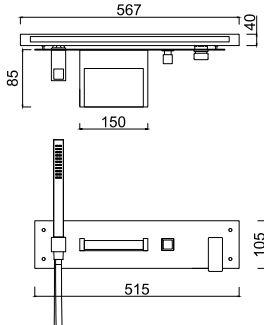

**Monocomando vasca incasso, bocca cascata, set doccia, cornice incasso.**  
Built-in bath mixer, cascade spout, shower kit, built-in framework.  
Mitigeur bain-douche à encastrer, bec cascade, ensemble de douche, gâche d'encastrement.  
UP-Einhebel-Wannenmischer, Wasserfall-Auslauf, Brauseset, Einbaurahmen.  
Monomando bañera empotrado, caño cascada, kit de ducha, estructura empotrada.  
Встраиваемый смеситель для ванны, каскадный излив, душевой набор, встраиваемая рамка

Articolo	Note	CROMO	BO-NO-NKO	BEO
9861-B1		1.540,00	•	•

9860BD

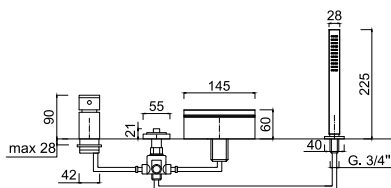
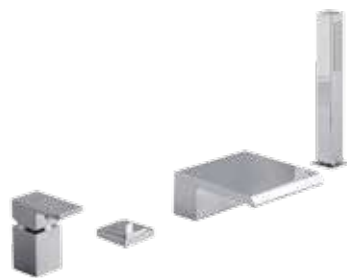

**Monocomando bordo vasca 4 fori, bocca, deviatore, doccia.**  
4-hole deck mounted set with mixer, spout, diverter and hand-shower included.  
Mitigeur bain-douche sur gorge 4 trous, bec, inverseur, douchette.  
4-Loch Wannenrandarmatur inkl. Mischer, Auslauf, Umsteller und Handbrause.  
Monomando bañera de repisa 4 agujeros, caño, inversor, ducha de mano.  
Комплект на 4 отверстия со смесителем на край ванны, излив, дивертер и ручной душ включены

Articolo	Note	CROMO	BO-NO-NKO	BEO
9860BD		800,00	1.200,00*	1.440,00*

9892

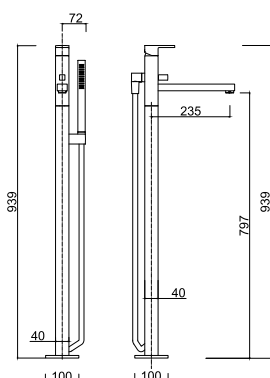

**Monocomando vasca a pavimento (con scatola incasso)**  
Free-standing bath mixer (with built-in box).  
Mitigeur baignoire à terre (avec la boîte murale).  
Wannenmischer mit Standfuß Schlauch (mit Montagedose auf den Boden).  
Monomando bañera a pavimento (con caja de montaje en el suelo).  
Свободно-стоящий смеситель для ванны (со встраиваемой коробкой).

Articolo	Note	CROMO	BO-NO-NKO	BEO
9892		1.750,00	2.362,00*	•

9856/B1

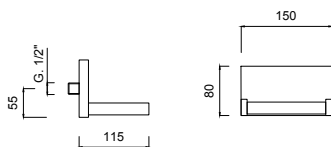

**Bocca cascata a muro per vasca.**  
Wall waterfall spout for deck-mounted mixer.  
Bec mural à cascade pour gorge baignoire.  
Wasserfall-Auslauf fuer Badewanne.  
Caño mural en cascada para bañera de repisa.  
Настенный излив каскадом для ванной

Articolo	Note	CROMO	BO-NO-NKO	BEO
9856/B1		690,00	•	•

**9856/B5**

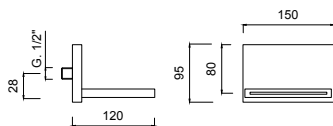

**Bocca cascata a muro per vasca.**  
*Wall waterfall spout for deck-mounted mixer.*  
*Bec mural à cascade pour gorge baignoire.*  
*Wasserfall-Auslauf fuer Badewanne.*  
*Caño mural en cascada para bañera de repisa.*  
*Настенный излив каскадом для ванной.*

Articolo	Note	CROMO	BO-NO-NKO	BEO	
<b>9856/B5</b>		690,00	•	•	

**9855/B1**

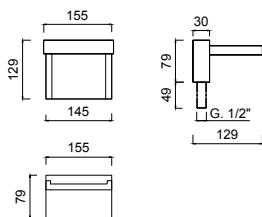

**Bocca cascata bordo vasca.**  
*Wall waterfall spout for deck-mounted mixer.*  
*Bec mural à cascade pour gorge baignoire.*  
*Wasserfall-Auslauf fuer Badewanne.*  
*Caño mural en cascada para bañera de repisa.*  
*Излив каскадом для установки на борту ванны.*

Articolo	Note	CROMO	BO-NO-NKO	BEO	
<b>9855/B1</b>		730,00	•	•	

**9855/B5**

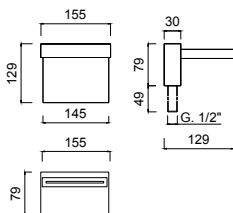

**Bocca cascata bordo vasca.**  
*Wall waterfall spout for deck-mounted mixer.*  
*Bec mural à cascade pour gorge baignoire.*  
*Wasserfall-Auslauf fuer Badewanne.*  
*Caño mural en cascada para bañera de repisa.*  
*Излив каскадом для установки на борту ванны.*

Articolo	Note	CROMO	BO-NO-NKO	BEO	
<b>9855/B5</b>		715,00	•	•	

**9857-14**

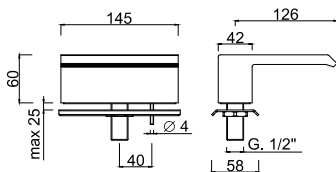

**Bocca cascata bordo vasca.**  
*Wall waterfall spout for deck-mounted mixer.*  
*Bec mural à cascade pour gorge baignoire.*  
*Wasserfall-Auslauf fuer Badewanne.*  
*Caño mural en cascada para bañera de repisa.*  
*Излив каскадом для установки на борту ванны.*

Articolo	Note	CROMO	BO-NO-NKO	BEO	
<b>9857-14</b>		440,00	•	•	

**9857-28**

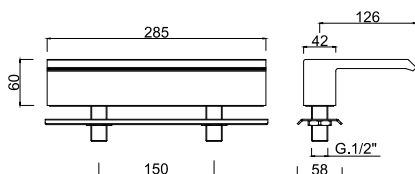

**Bocca cascata bordo vasca.**  
*Wall waterfall spout for deck-mounted mixer.*  
*Bec mural à cascade pour gorge baignoire.*  
*Wasserfall-Auslauf fuer Badewanne.*  
*Caño mural en cascada para bañera de repisa.*  
*Излив каскадом для установки на борту ванны.*

Articolo	Note	CROMO	BO-NO-NKO	BEO	
<b>9857-28</b>		690,00	•	•	

**5103L**

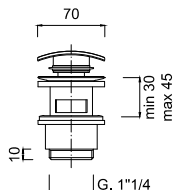

**Scarico per lavabo Up&Down 1"1/4.**  
Basin drain 1"1/4 Up&Down.  
Vidage lavabo Up&Down 1"1/4.  
Ablaufgarnitur Up&Down 1"1/4.  
Desague automatico Up&Down 1"1/4.  
Слив для раковины Up&Down 1"1/4

Articolo	Note	CROMO	BO-NO-NKO	BEO
<b>5103L</b>		55,00	77,00	99,00

**5109PL**

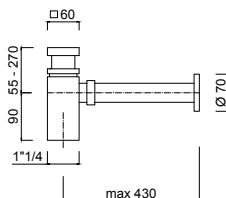

**Sifone per Lavabo 1"1/4.**  
Trap for basin 1"1/4 .  
Siphon lavabo 1"1/4.  
Röhrensifon Waschtsch 1"1/4.  
Sifón para lavabo 1"1/4.  
Сифон для раковины 1"1/4

Articolo	Note	CROMO	BO-NO-NKO	BEO
<b>5109PL</b>		95,00	140,00	171,00

**3264PL**

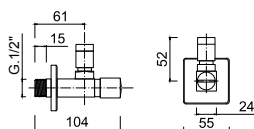

**Rubinetto sottolavabo con filterstop.**  
Under-sink valve with filterstop.  
Coude sous lavabo avec filterstop.  
Eckventile mit Filter.  
Llave de paso para lavabo con filterstop.  
Вентиль под раковину с filterstop

Articolo	Note	CROMO	BO-NO-NKO	BEO
<b>3264PL</b>		79,00	119,00	143,00

**1665**

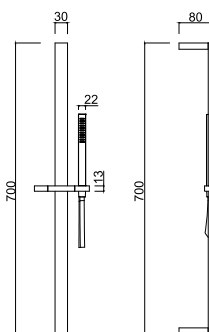

**Saliscendi in ottone con doccia monogetto .**  
Brass sliding bar and 1 jet handshower.  
Barre de douche en laiton avec douchette 1 jet .  
Brausestange in Messing mit Handbrause 1 Strahl .  
Barra deslizante en latón con ducha teléfono 1 chorro .  
Штанга для душа и ручной душ , один режим.

Articolo	Note	CROMO	BO-NO-NKO	BEO
<b>1665</b>		264,00	535,00	550,00

1667

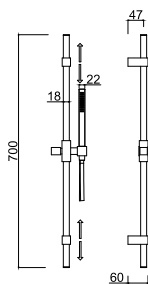

**Saliscendi in ottone con doccia monogetto .**  
Brass sliding bar and 1 jet handshower.  
Barre de douche en laiton avec douchette 1 jet .  
Brausestange in Messing mit Handbrause 1 Strahl .  
Barra deslizante en latón con ducha teléfono 1 chorro .  
Штанга для душа и ручной душ , один режим.

Articolo	Note	CROMO	BO-NO-NKO	BEO	
1667		244,00	•	•	

1510QD

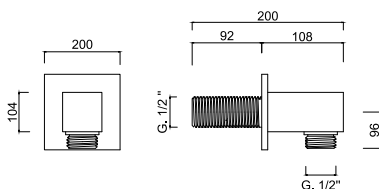

**Presacqua 1/2".**  
Water plug 1/2".  
Prise d'eau mural 1/2".  
Wandanschlussbogen 1/2" für Brauseanschl. .  
Toma de agua 1/2".  
Крепление к стене для гибкого шланга

Articolo	Note	CROMO	BO-NO-NKO	BEO	
1510QD		40,00	66,00	72,00	

1626QD

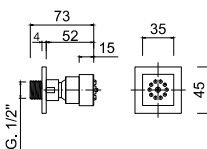

**Soffioncino orientabile laterale esterno.**  
External adjustable lateral body spray.  
Douchette latérale extérieure orientable.  
Externe verstellbare Seitenkörperbrause.  
Ducha lateral externa ajustable.  
Боковая регулируемая форсунка наружного монтажа

Articolo	Note	CROMO	BO-NO-NKO	BEO	
1626QD		61,00	•	•	

3250-13



**Kit prolunga (mm.130). Specificare per quale articolo.**  
Kit long extension (mm.130). Specify for which item.  
Kit rallonge (mm.130). Spécifier pour quel article.  
Kit verlängerung (mm.130). Für welche Artikelnummer nennen.  
Kit alargador (mm.130). Especificquen la referencia.  
Комплект долго расширение (mm.130). Уточнить, для какого артикула

Articolo	Note	CROMO	BO-NO-NKO	BEO	
3250-13		95,00	143,00	171,00	



**NOTE**

**Potete trovare altre soluzioni per la Doccia nell'area WELLNESS. p.374**

*For additional Shower options please go to WELLNESS section.*

*Pour plus de solutions pour la Douche visitez la section WELLNESS.*

*Für weitere Duschalternativen sehen Sie bitte in dem Kapitel WELLNESS nach.*

*Para más soluciones para Ducha visite la sección WELLNESS.*

*Другие решения для Душа вы найдете в разделе Wellness.*

**Per gli Accessori Bagno abbinati alla serie potete consultare la serie ERICA. p.440**

*For matching Bathroom Fittings please check ERICA line.*

*Pour les Accessoires Salle de Bains coordonnés à la collection visitez la ligne ERICA.*

*Die zu der Serie passenden Bad-Accessoires finden Sie in dem Linie ERICA.*

*Para los Accesorios de Baño compatibles con la serie visite la línea ERICA.*

*Чтобы подобрать подходящие аксессуары для ванной комнаты, перейдите в Линия ERICA.*

Futuro









**6533A**

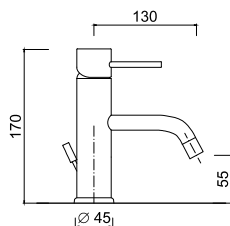

**Monocomando lavabo, scarico 1"1/4 (con flessibile).**  
Wash-basin single-lever mixer, 1"1/4 pop-up waste (with flexible).  
Mitigeur lavabo avec vidage 1"1/4 (avec flexible).  
Einhand-Waschtischbatterie mit Ablaufgarnitur 1"1/4 (mit flexiblen Anschlussschläuchen).  
Monomando lavabo tapón accionado por varilla 1"1/4 (con flexible).  
Однорычажный смеситель для раковины, донный клапан 1"1/4 (гибкая подводка).

Articolo	Note	CROMO	BO-NO-NKO		
<b>6533A</b>		166,00	224,00		
<b>6533/SC</b>	SC	153,00	211,00		

**6533A-15**

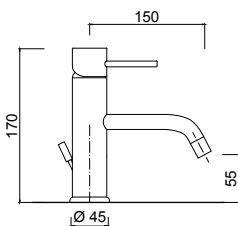

**Monocomando lavabo, bocca mm.150, scarico 1"1/4 (con flessibile).**  
Wash-basin mixer, spout mm. 150, 1"1/4 pop-up waste (with flexibles).  
Mitigeur lavabo, bec mm 150, vidage 1"1/4 (avec flexibles).  
Einhebel-Waschtischmischer, Auslauf mm 150, Ablaufgarnitur 1"1/4 (inkl. Anschlussschläuche).  
Monomando lavabo, caño mm 150, desagüe automatico 1"1/4 (con flex.).  
Смеситель для раковины, излив 150 мм., с донным клапаном на 1"1/4 (с гибкими шлангами)

Articolo	Note	CROMO	BO-NO-NKO		
<b>6533A-15</b>		172,00	232,00		
<b>6533-15/SC</b>	SC	159,00	219,00		

**6505A**

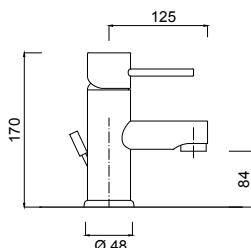

**Monocomando lavabo, scarico 1"1/4 (con flessibile).**  
Wash-basin single-lever mixer, 1"1/4 pop-up waste (with flexible).  
Mitigeur lavabo avec vidage 1"1/4 (avec flexible).  
Einhand-Waschtischbatterie mit Ablaufgarnitur 1"1/4 (mit flexiblen Anschlussschläuchen).  
Monomando lavabo tapón accionado por varilla 1"1/4 (con flexible).  
Однорычажный смеситель для раковины, донный клапан 1"1/4 (гибкая подводка).

Articolo	Note	CROMO	BO-NO-NKO		
<b>6505A</b>		166,00	249,00		
<b>6505/SC</b>	SC	153,00	229,00		

**6505A-15**

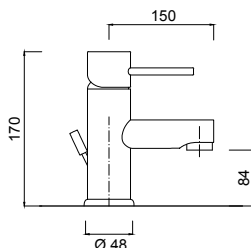

**Monocomando lavabo, bocca mm.150, scarico 1"1/4 (con flessibile).**  
Wash-basin mixer, spout mm. 150, 1"1/4 pop-up waste (with flexibles).  
Mitigeur lavabo, bec mm 150, vidage 1"1/4 (avec flexibles).  
Einhebel-Waschtischmischer, Auslauf mm 150, Ablaufgarnitur 1"1/4 (inkl. Anschlussschläuche).  
Monomando lavabo, caño mm 150, desagüe automatico 1"1/4 (con flex.).  
Смеситель для раковины, излив 150 мм., с донным клапаном на 1"1/4 (с гибкими шлангами)

Articolo	Note	CROMO	BO-NO-NKO		
<b>6505A-15</b>		172,00	258,00		
<b>6505A-15/SC</b>	SC	159,00	238,00		

**6545A Futuro Hi**

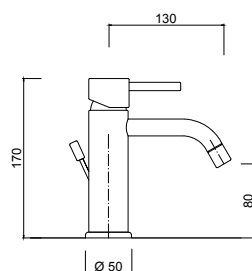

**Monocomando lavabo uscita alta, scarico 1"1/4 (con flessibili).**  
Wash-basin mixer with high spout, 1"1/4 pop-up waste (with flexibles).  
Mitigeur lavabo avec bec haut, vidage 1"1/4 (avec flexibles).  
Einhebel-Waschtischmischer mit hohem Auslauf, Ablaufgarnitur 1"1/4 (inkl. Anschlussschläuche).  
Monomando lavabo con caño alto, desagüe automatico 1"1/4 (con flex.).  
Смеситель для раковины с высоким изливом, с донным клапаном на 1"1/4 (с гибкими шлангами)

Articolo	Note	CROMO	BO-NO-NKO		
<b>6545A</b>		177,00	265,00		
<b>6545/SC</b>	SC	164,00	245,00		

**6595A Futuro Mini**

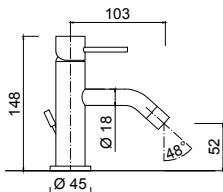

**Monocomando lavabo, scarico 1"1/4 (con flessibile).**  
Wash-basin single-lever mixer, 1"1/4 pop-up waste (with flexible).  
Mitigeur lavabo avec vidage 1"1/4 (avec flexible).  
Einhand-Waschtischbatterie mit Ablaufgarnitur 1"1/4 (mit flexiblen Anschlusschläuchen).  
Monomando lavabo tapón accionado por varilla 1"1/4 (con flexible).  
Однорычажный смеситель для раковины, донный клапан 1"1/4 (гибкая подводка).

Articolo	Note	CROMO	BO-NO-NKO
6595A		141,00	•
6595/SC	SC	128,00	•

**6520-25**

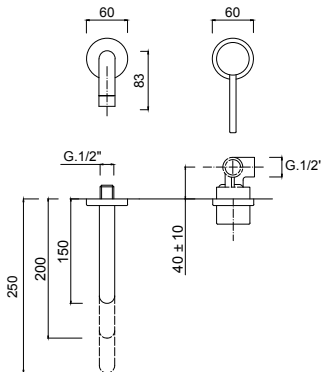
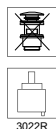

**Monocomando lavabo a muro, senza scarico, mm.250**  
Wall-mounted wash-basin set, without pop-up waste.  
Mitigeur lavabo mural, sans vidage.  
Waschtisch- Einhebelmischer Wandmontage, ohne Ablaufgarnitur.  
Lavabo de pared, sin desagüe.  
Комплект настенного монтажа для раковины, без донного клапана.

Articolo	Note	CROMO	BO-NO-NKO
6520-25	mm 250	145,00	196,00
6520-20	mm 200	145,00	196,00
6520-15	mm 150	145,00	196,00

**6520P-25**

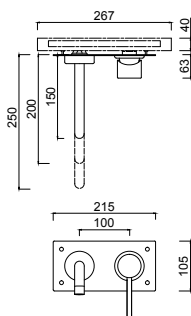

**Monocomando lavabo a muro, bocca mm 250, cornice incasso, senza scarico.**  
Wall-mounted wash-basin mixer, spout mm 250, built-in framework, without pop-up waste.  
Mitigeur lavabo mural, bec mm 250, gâche d'encastrement, sans vidage.  
Einhebel-Waschtischmischer für die Wandmontage, Auslauf mm 250, Edelstahl-Einbaurahmen, ohne Ablaufgarnitur.  
Monomando lavabo mural, caño mm 250, estructura empotrada, sin desagüe automatico.  
Смеситель для раковины настенного монтажа, излив 250 мм, встраиваемая рамка, без донного клапана

Articolo	Note	CROMO	BO-NO-NKO
6520P-25	mm 250	440,00	•
6520P-20	mm 200	440,00	•
6520P-15	mm 150	440,00	•

**6523-25**

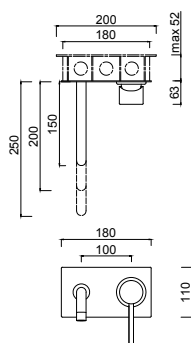

**Monocomando lavabo a muro, bocca mm 250, box incasso, senza scarico.**  
Wall-mounted wash-basin mixer, spout mm 250, built-in box, without pop-up waste.  
Mitigeur lavabo mural, bec mm 250, box d'encastrement, sans vidage.  
Einhebel-Waschtischmischer für die Wandmontage, Auslauf mm 250, Einbau-Box, ohne Ablaufgarnitur.  
Monomando lavabo mural, caño mm 250, box empotrado incluido, sin desagüe automatico.  
Смеситель для раковины настенного монтажа, излив 250 мм, встраиваемый бокс, без донного клапана

Articolo	Note	CROMO	BO-NO-NKO
6523-25	mm 250	319,00	•
6523-20	mm 200	319,00	•
6523-15	mm 150	319,00	•

**6585A**

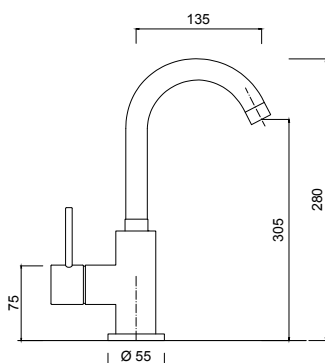
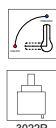

**Monocomando lavabo, bocca girevole, scarico 1"1/4 (con flessibile).**  
Wash-basin mixer, swivel spout, 1"1/4 pop-up waste (with flexible).  
Mitigeur lavabo, bec mobile, vidage automatique 1"1/4 (avec flex.).  
Waschtisch-Einhebelmischer, Schwenkbarer Rohrauslauf, 1"1/4 Zugknopf Ablaufgarnitur (mit flexiblen Anschlusschläuchen).  
Monomando lavabo, caño giratorio, tapón accionado por varilla 1"1/4 (con flex.).  
Смеситель для раковины, поворотный излив, донный клапан 1"1/4 (гибкая подводка).

Articolo	Note	CROMO	BO-NO-NKO
6585A		223,00	301,00
6585/SC	SC	210,00	288,00

**6581A**

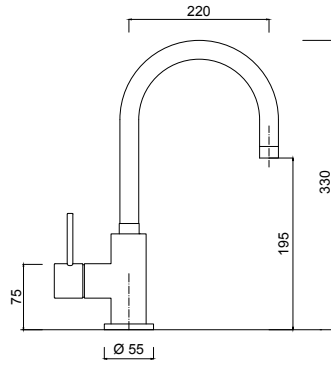
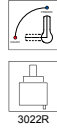

**Monocomando lavabo, bocca girevole a PONTE, scarico 1"1/4 (con flessibile).**

Wash-basin mixer, swivel spout, 1"1/4 pop-up waste (with flexibles).  
Mitigeur lavabo, bec orientable, vidage 1"1/4 (avec flexibles).  
Einhebel-Waschtischmischer mit Schwenkauslauf, Ablaufgarnitur 1"1/4 (inkl. Anschlusschläuche).  
Monomando lavabo con caño orientable, desagüe automático 1"1/4 (con flex.).  
Смеситель для раковины с поворотным изливом, с донным клапаном на 1"1/4 (с гибкими шлангами)

Articolo	Note	CROMO	BO-NO-NKO		
6581A		237,00	356,00		
6581/SC	SC	224,00	336,00		

**6527A**

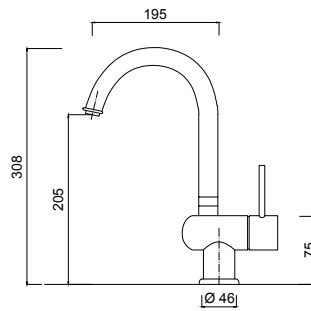

**Monocomando lavabo, bocca girevole, scarico 1"1/4 (con flessibile).**

Wash-basin mixer, swivel spout, 1"1/4 pop-up waste (with flexible).  
Mitigeur lavabo, bec mobile, vidage automatique 1"1/4 (avec flex.).  
Waschtisch-Einhebelmischer, Schwenkbarer Rohrauslauf, 1"1/4 Zugknopf Ablaufgarnitur (mit flexiblen Anschlusschläuchen).  
Monomando lavabo, caño giratorio, tapón accionado por varilla 1"1/4 (con flex.).  
Смеситель для раковины, поворотный излив, донный клапан 1"1/4 (гибкая подводка).

Articolo	Note	CROMO	BO-NO-NKO		
6527A		206,00	309,00		
6527/SC	SC	193,00	289,00		

**6537A-15**

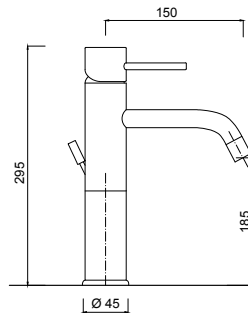

**Monocomando lavabo con prolunga, bocca mm.150, scarico 1"1/4 (con flessibile).**

Wash-basin mixer with extension, spout mm 150, 1"1/4 pop-up waste (with flexibles).  
Mitigeur lavabo rehaussé, bec mm 150, vidage 1"1/4 (avec flexibles).  
Hoher Einhebel-Waschtischmischer, Auslauf mm 150, Ablaufgarnitur 1"1/4 (inkl. Anschlusschläuche).  
Monomando lavabo alto, caño mm 150, desagüe automático 1"1/4 (con flex.).  
Смеситель для раковины с удлинением, изливом 150 мм., с донным клапаном на 1"1/4 (с гибкими шлангами)

Articolo	Note	CROMO	BO-NO-NKO		
6537A-15		228,00	308,00		
6537-15/SC	SC	215,00	295,00		

**6511A-15**

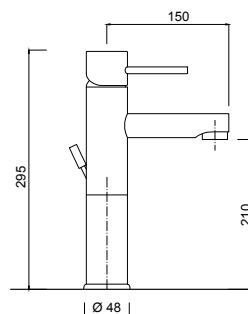

**Monocomando lavabo con prolunga, bocca mm.150, scarico 1"1/4 (con flessibile).**

Wash-basin mixer with extension, spout mm 150, 1"1/4 pop-up waste (with flexibles).  
Mitigeur lavabo rehaussé, bec mm 150, vidage 1"1/4 (avec flexibles).  
Hoher Einhebel-Waschtischmischer, Auslauf mm 150, Ablaufgarnitur 1"1/4 (inkl. Anschlusschläuche).  
Monomando lavabo alto, caño mm 150, desagüe automático 1"1/4 (con flex.).  
Смеситель для раковины с удлинением, изливом 150 мм., с донным клапаном на 1"1/4 (с гибкими шлангами)

Articolo	Note	CROMO	BO-NO-NKO		
6511A-15		228,00	308,00		
6511-15/SC	SC	215,00	295,00		

**6539A**

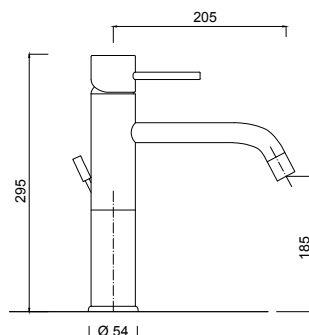

**Monocomando lavabo con prolunga, bocca lunga, scarico 1"1/4 (con flessibile)**

High wash-basin single-lever mixer with long spout, 1"1/4 pop-up waste (with flex.).  
Mitigeur lavabo haut avec bec long, avec vidage 1"1/4 (avec flexible).  
Einhand-Waschtischbatterie mit hohem und langem Auslauf, mit Ablaufgarnitur 1"1/4 (mit flexiblen Anschlusschläuchen).  
Monomando lavabo alto con caño longo, tapón accionado por varilla 1"1/4 (con flex.).  
Высокий однорычажный смеситель для раковины с удлиненным изливом, донный клапан 1"1/4 (гибкая подводка).

Articolo	Note	CROMO	BO-NO-NKO		
6539A		238,00	318,00		
6539/SC	SC	225,00	305,00		



6549A

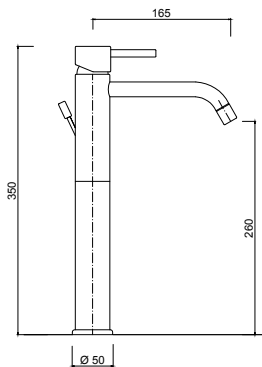

**Monocomando lavabo con prolunga, uscita alta, scarico 1"1/4 (con flessibile).**

Wash-basin mixer with extension, high spout, 1"1/4 pop-up waste (with flexibles).

Mitigeur lavabo rehaussé, bec haut, vidage 1"1/4 (avec flexibles).

Hoher Einhebel-Waschtischmischer mit hohem Auslauf, Ablaufgarnitur 1"1/4 (inkl. Anschlussschläuche).

Monomando lavabo alto, desagüe automático 1"1/4 (con flex.).

Смеситель для раковины с удлинением, с донным клапаном на 1"1/4 (с гибкими шлангами)

Articolo	Note	CROMO	BO-NO-NKO		
6549A		230,00	345,00		
6549/SC	SC	217,00	325,00		

6596/SC Futuro Mini

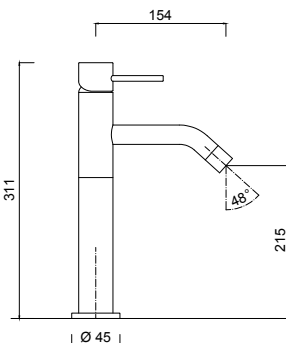
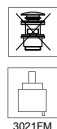

**Monocomando lavabo con prolunga, bocca lunga, SENZA scarico (con flessibile).**

Wash-basin mixer with extension, long spout, without pop-up waste (with flexibles).

Mitigeur lavabo rehaussé, bec long, sans vidage (avec flexibles).

Hoher Einhebel-Waschtischmischer mit langem Auslauf, ohne Ablaufgarnitur (inkl. Anschlussschläuche).

Monomando lavabo alto, caño largo, sin desagüe automático (con flex.).

Смеситель для раковины с удлинением, длинным изливом, с донным клапаном на 1"1/4 (с гибкими шлангами)

Articolo	Note	CROMO	BO-NO-NKO		
6596/SC		161,00	•		

6582/SC

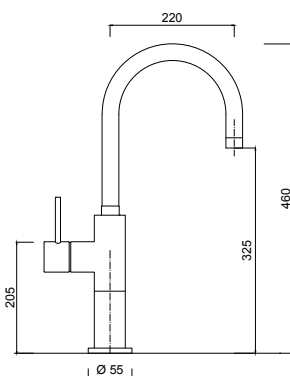
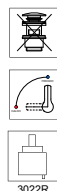

**Monocomando lavabo con prolunga, bocca girevole a PONTE, scarico 1"1/4 (con flessibile).**

Wash-basin mixer with extension, swivel spout, 1"1/4 pop-up waste (with flexibles).

Mitigeur lavabo rehaussé, bec orientable, vidage 1"1/4 (avec flexibles).

Hoher Einhebel-Waschtischmischer mit Schwenkauslauf, Ablaufgarnitur 1"1/4 (inkl. Anschlussschläuche).

Monomando lavabo alto, caño orientable, desagüe automático 1"1/4 (con flex.).

Смеситель для раковины с удлинением, поворотным изливом, с донным клапаном на 1"1/4 (с гибкими шлангами)

Articolo	Note	CROMO	BO-NO-NKO		
6582/SC		315,00	472,00		

6590

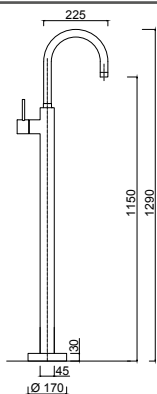
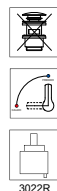

**Monocomando lavabo a pavimento, bocca girevole**

Wash-basin single-lever mixer with floor pillar leg, swivel spout.

Mitigeur lavabo avec colonnette alimentation par le sol, bec mobile.

Waschtisch-Einhebelmischer mit Standfuß Schlauch, Schwenkbarer Rohrauslauf.

Monomando lavabo con colonna a pavimento, caño giratorio.

Однорычажный смеситель для раковины с напольной колонной, поворотный излив.

Articolo	Note	CROMO	BO-NO-NKO		
6590		950,00	1.283,00		

6535A

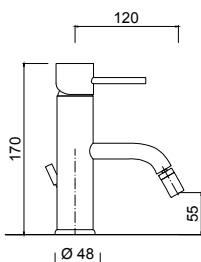

**Monocomando bidet, scarico 1"1/4 (con flessibile).**

Bidet single-lever mixer, 1"1/4 pop-up waste (with flexible).

Mitigeur bidet avec vidage 1"1/4 (avec flexible).

Einhand-Bidetbatterie mit Ablaufgarnitur 1"1/4 (mit flexiblen Anschlussschläuchen).

Monomando bidet, tapón accionado por varilla 1"1/4 (con flexible).

Однорычажный смеситель для биде, донный клапан 1"1/4 (гибкая подводка).

Articolo	Note	CROMO	BO-NO-NKO		
6535A		166,00	224,00		

6507A

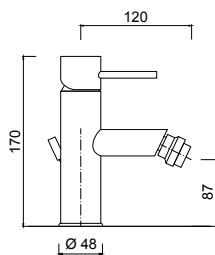

**Monocomando bidet, scarico 1"1/4 (con flessibile).**  
Bidet single-lever mixer, 1"1/4 pop-up waste (with flexible).  
Mitigeur bidet avec vidage 1"1/4 (avec flexible).  
Einhand-Bidetbatterie mit Ablaufgarnitur 1"1/4 (mit flexiblen Anschlusschläuchen).  
Monomando bidet, tapón accionado por varilla 1"1/4 (con flexible).  
Однорычажный смеситель для биде, донный клапан 1"1/4 (гибкая подводка).

Articolo	Note	CROMO	BO-NO-NKO		
6507A		166,00	249,00		

6547A Futuro Hi

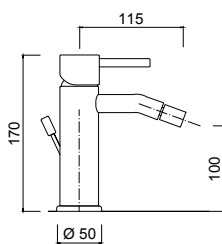

**Monocomando bidet, uscita alta, scarico 1"1/4 (con flessibile).**  
Bidet mixer, high spout, 1"1/4 pop-up waste (with flexibles).  
Mitigeur bidet, bec haut, vidage 1"1/4 (avec flexibles).  
Einhebel-Bidetmischer, hoher Auslauf, Ablaufgarnitur 1"1/4 (inkl. Anschlusschläuche).  
Monomando bidé, caño alto, desagüe automatico 1"1/4 (con flex.).  
Смеситель для биде, высоким изливом, с донным клапаном на 1"1/4 (с гибкими шлангами)

Articolo	Note	CROMO	BO-NO-NKO		
6547A		177,00	265,00		

6597A Futuro Mini

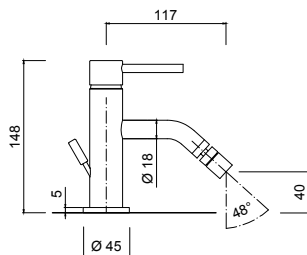

**Monocomando bidet, scarico 1"1/4 (con flessibile).**  
Bidet single-lever mixer, 1"1/4 pop-up waste (with flexible).  
Mitigeur bidet avec vidage 1"1/4 (avec flexible).  
Einhand-Bidetbatterie mit Ablaufgarnitur 1"1/4 (mit flexiblen Anschlusschläuchen).  
Monomando bidet, tapón accionado por varilla 1"1/4 (con flexible).  
Однорычажный смеситель для биде, донный клапан 1"1/4 (гибкая подводка).

Articolo	Note	CROMO	BO-NO-NKO		
6597A		141,00	•		

6587A

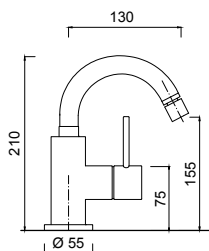

**Monocomando bidet, bocca girevole, scarico 1"1/4 (con flessibile)**  
Bidet mixer, swivel spout, 1"1/4 pop-up waste (with flexible).  
Mitigeur bidet, bec mobile, vidage automatique 1"1/4 (avec flex.).  
Bidet-Einhebelmischer, Schwenkbarer Rohrauslauf, 1"1/4 Zugknopf Ablaufgarnitur (mit flexiblen Anschlusschläuchen).  
Monomando bidet, caño giratorio, tapón accionado por varilla 1"1/4 (con flex.).  
Смеситель для биде, поворотный излив, донный клапан 1"1/4 (гибкая подводка).

Articolo	Note	CROMO	BO-NO-NKO		
6587A		223,00	301,00		

6529A

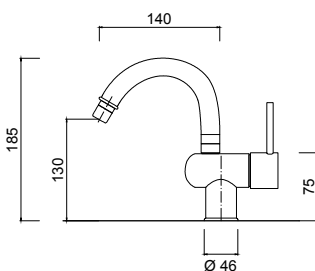

**Monocomando bidet, bocca girevole, scarico 1"1/4 (con flessibile)**  
Bidet mixer, swivel spout, 1"1/4 pop-up waste (with flexible).  
Mitigeur bidet, bec mobile, vidage automatique 1"1/4 (avec flex.).  
Bidet-Einhebelmischer, Schwenkbarer Rohrauslauf, 1"1/4 Zugknopf Ablaufgarnitur (mit flexiblen Anschlusschläuchen).  
Monomando bidet, caño giratorio, tapón accionado por varilla 1"1/4 (con flex.).  
Смеситель для биде, поворотный излив, донный клапан 1"1/4 (гибкая подводка).

Articolo	Note	CROMO	BO-NO-NKO		
6529A		206,00	309,00		

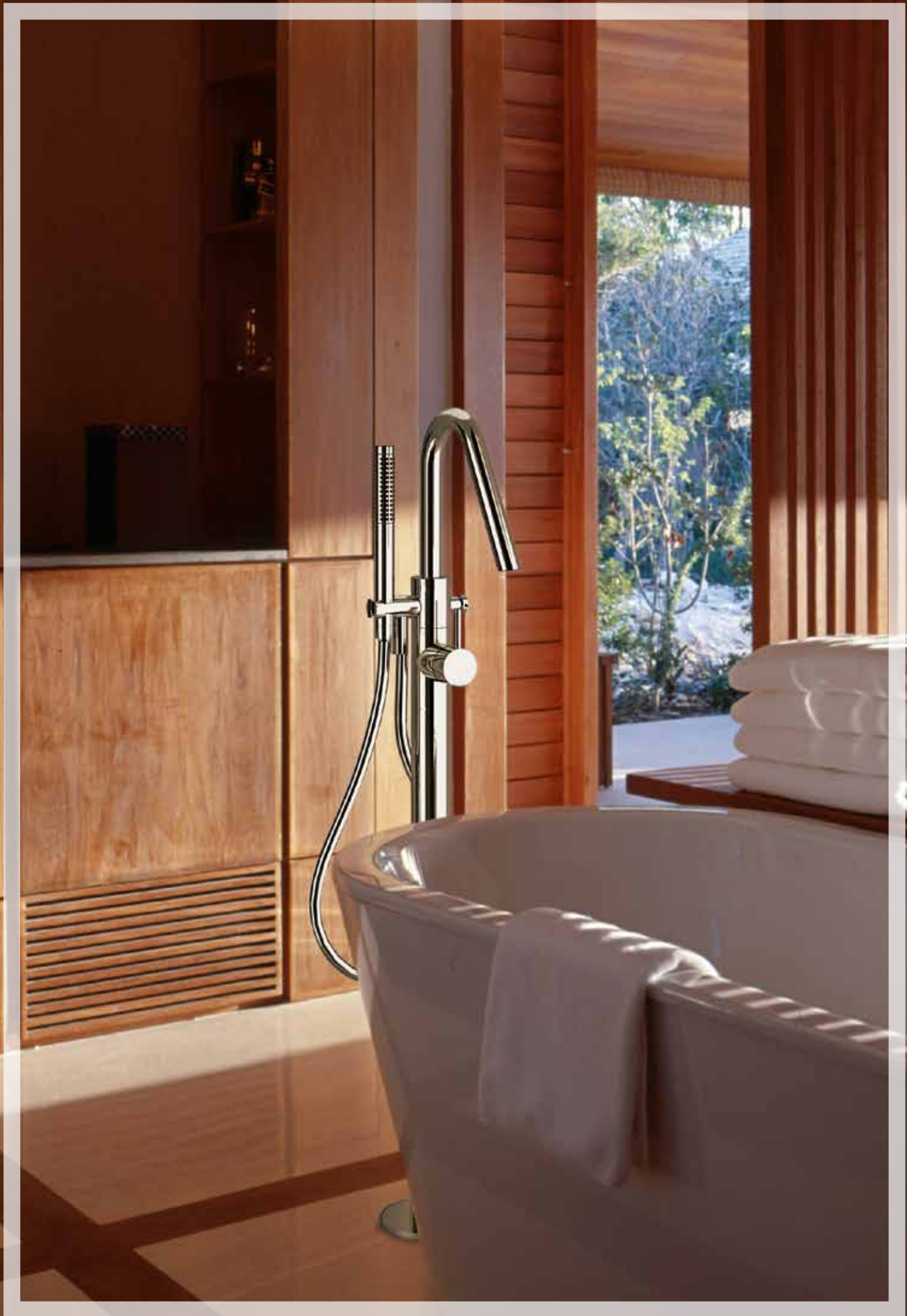

**SH25**

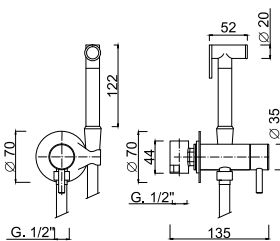

**Miscelatore monocomando incasso per bidet**

Built-in single-lever mixer for bidet  
Mitigeur à encastrer pour bidet  
UP-Einhebelmischer für Bidet  
Monomando empotrado para bidé  
Однорычажный встраиваемый смеситель для биде.

Articolo	Note	CROMO	BO-NO-NKO		
SH25		150,00	290,00		

**6515WB-25**

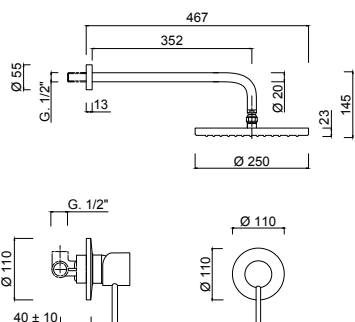
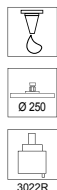

**Set doccia incasso monocomando, soffione ottone**

Shower built-in single-lever mixer, brass shower head.  
Mitigeur pour douche à encaissement, pomme de douche en laiton.  
Unterputz-Duscheneinhebelmischer, Kopfbrause in Messing.  
Monomando ducha para empotrar, rociador en latón.  
Однорычажный встроенный смеситель для душа, верхний душ из латуни

Articolo	Note	CROMO	BO-NO-NKO		
6515WB-25		420,00	645,00		

**6515WS**

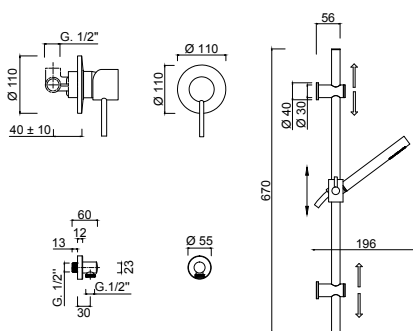

**Set doccia incasso monocomando, saliscendi, presa acqua.**

Built-in shower mixer with sliding rail and water plug.  
Mitigeur douche à encastrer avec barre de douche et prise d'eau.  
UP-Einhebel-Brausemischer mit Brausestange, Brausest und Wandanschlussbogen.  
Kit de ducha empotrado con barra deslizante y toma de agua.  
Встраиваемый смеситель для душа с регулируемой штангой и разъемом для подачи воды

Articolo	Note	CROMO	BO-NO-NKO		
6515WS		230,00	524,00		

**6515WC-S**

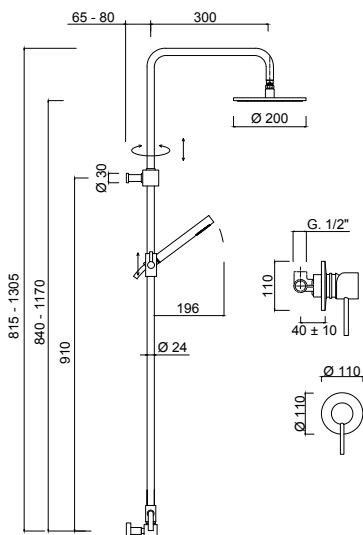

**Set doccia incasso monocomando, supporto presa/acqua, colonna doccia con soffione ottone.**

Built-in shower mixer with holder/water plug, shower column and brass showerhead.  
Mitigeur douche à encastrer avec support/prise d'eau, colonne de douche et douche de tête en laiton.  
UP-Einhebel-Brausemischer, Brausehalter/Wandanschlussbogen, Duschsäule mit Kopfbrause aus Messing.  
Conjunto monomando ducha empotrado, soporte/toma de agua, rociador en latón.  
Встраиваемый смеситель для душа с держателем/разъемом для подачи воды, душевой колонной и верхним душем из латуни

Articolo	Note	CROMO	BO-NO-NKO		
6515WC-S		713,00	1.334,00		

**6513KB-25**

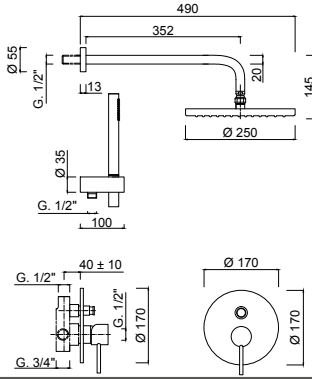
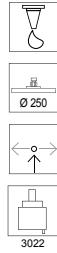

**Set doccia incasso monocomando con deviatore, soffione ottone, kit duplex incasso**

*Shower built-in single-lever mixer with diverter, brass shower head, built-in duplex shower kit*  
 Mitigeur pour douche à encaissement avec inverseur, pomme de douche en laiton, ensemble de douche duplex à encaissement  
 Unterputz-Duscheneinheimischer mit Umstellung, Brausekopf in Messing, Einbau-Brausekit Duplex  
 Monomando ducha para empotrar con desviador, rociador ducha en latón, conjunto ducha duplex para empotrar  
 Однорычажный встроенный смеситель для душа с дивертером, верхний душ из латуни, встроенный душевой набор "Duplex"

Articolo	Note	CROMO	BO-NO-NKO
6513KB-25		605,00	990,00

**6513-3-25KBS**

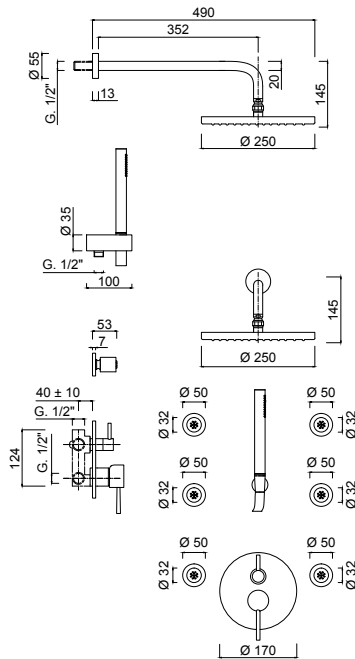

**Set doccia incasso monocomando con deviatore 3 uscite, soffione ottone, kit duplex incasso, 6 soffioncini incasso laterali.**

*Built-in shower mixer with 3-ways diverter, brass showerhead, built-in duplex shower kit, 6 built-in body sprays.*  
 Mitigeur douche à encaissement avec inverseur à 3 sorties, pomme de douche en laiton, ensemble de douche duplex à encaissement, 6 douchettes latérales murales.  
 UP-Einhebel-Brausemischer mit 3-Wege-Umstellung, Kopfbrause aus Messing, UP-Brausekit, 6 Körperbrausen.  
 Monomando ducha empotrado con inversor 3 vías, rociador en latón, kit de ducha, 6 jets laterales empotrados.  
 Встраиваемый смеситель для душа с дивертером на 3 выхода, верхний душ из латуни, встраиваемый душевой набор "Duplex", 6 встраиваемых боковых форсунок.

Articolo	Note	CROMO	BO-NO-NKO
6513-3-25KBS		999,00	•

**6515**

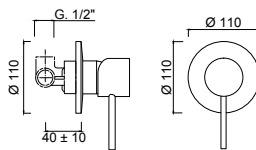

**Monocomando doccia incasso.**

*Shower built-in single-lever mixer.*  
 Mitigeur pour douche à encaissement.  
 Unterputz-Duscheneinheimischer.  
 Monomando ducha para empotrar.  
 Однорычажный встроенный смеситель для душа.

Articolo	Note	CROMO	BO-NO-NKO
6515		80,00	119,00

**6513**

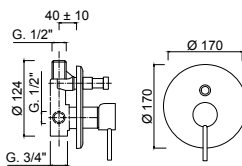
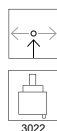

**Monocomando doccia incasso con deviatore.**

*Shower built-in single-lever mixer with diverter.*  
 Mitigeur pour douche à encaissement avec inverseur.  
 Unterputz-Duscheneinheimischer mit Umstellung.  
 Monomando ducha para empotrar con desviador.  
 Однорычажный встроенный смеситель для душа с дивертером.

Articolo	Note	CROMO	BO-NO-NKO
6513		175,00	261,00

**6513-3**

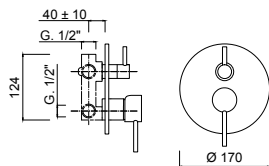
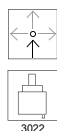

**Monocomando doccia incasso con deviatore 3 uscite**  
Shower built-in single-lever mixer with 3 outlets diverter  
Mitigeur pour douche à encaissement avec inverseur à 3 sorties  
Unterputz- Duscheneinhebelmischer mit 3-Augänge Umstellung  
Monomando ducha para empotrar con desviador a 3 salidas  
Однорычажный встроенный смеситель для душа с дивертером на 3 выхода

Articolo	Note	CROMO	BO-NO-NKO		
<b>6513-3</b>		266,00	399,00		

**6513-4**

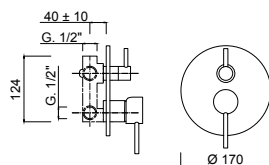
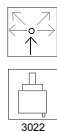

**Monocomando doccia incasso con deviatore 4 uscite**  
Shower built-in single-lever mixer with 4 outlets diverter  
Mitigeur pour douche à encaissement avec inverseur à 4 sorties  
Unterputz- Duscheneinhebelmischer mit 4-Augänge Umstellung  
Monomando ducha para empotrar con desviador a 4 salidas  
Однорычажный встроенный смеситель для душа с дивертером на 4 выхода

Articolo	Note	CROMO	BO-NO-NKO		
<b>6513-4</b>		283,00	425,00		

**8212-FU**

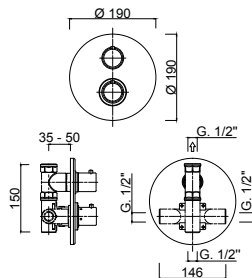

**Termostatico incasso 1/2", con rubinetto d'arresto 1/2.**  
Built-in thermostatic mixer 1/2", with built-in tap 1/2".  
Mitigeur thermostatique mural, 1/2", avec robinet mural 1/2".  
Eingebaute Einhebel Thermostatatterie 1/2", mit Ventil 1/2".  
Mezclador termostatico a empotrar 1/2", con grifo 1/2".  
Встраиваемый термостат 1/2" со встраиваемым смесителем 3/4".

Articolo	Note	CROMO	BO-NO-NKO		
<b>8212-FU</b>		440,00	594,00		

**8213-FU**

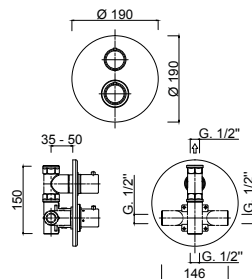

**Termostatico incasso 2 uscite**  
2 outlets built-in thermostatic mixer  
Mitigeur thermostatique mural à 2 sorties  
2-Ausgänge eingebaute Einhebel-Thermostatatterie  
Mezclador termostatico a empotrar a 2 salidas.  
Встроенный термостатический смеситель на 2 выхода

Articolo	Note	CROMO	BO-NO-NKO		
<b>8213-FU</b>		490,00	662,00		

**8276**

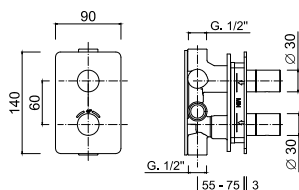
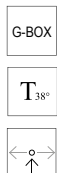

**Termostatico incasso 2 uscite, box incasso.**  
Built-in thermostatic mixer with 2 outlets, built-in box.  
Mitigeur thermostatique douche à encastrer avec 2 sorties, box d'encastrement.  
UP-Thermostat mit 2-Wege-Umstellung, inkl. Einbau-Box.  
Termostática empotrada 2 salidas, box empotrado incluido.  
Встраиваемый термостатический смеситель с 2 выходами, встраиваемый бокс

Articolo	Note	CROMO	BO-NO-NKO		
<b>8276</b>		760,00	1.026,00		

8277

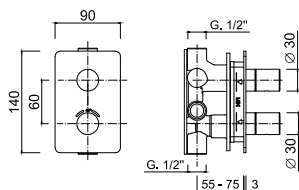
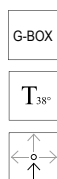

**Termostatico incasso 3 uscite, box incasso.**

Built-in thermostatic mixer with 3 outlets, built-in box.  
Mitigeur thermostatique douche à encastrer avec 3 sorties, box d'encastrement.

UP-Thermostat mit 3-Wege-Umstellung, inkl. Einbau Box.  
Termostática empotrada 3 salidas, box empotrado incluido.

Встраиваемый термостатический смеситель с 3 выходами, встраиваемый бокс

Articolo	Note	CROMO	BO-NO-NKO
8277		820,00	1.107,00

8278

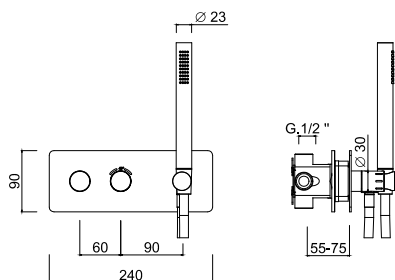
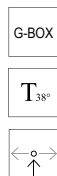

**Termostatico incasso, set doccia, 1 uscita libera, box incasso.**

Built-in thermostatic mixer, integrated shower set + 1 additional water outlet, built-in box.

Mitigeur thermostatique douche à encastrer, ensemble de douche + 1 sortie supplémentaire disponible, box d'encastrement.

UP-Thermostat, integrierte Brauseset + 1 zusätzlicher Verbraucher, inkl. Einbau Box.

Termostática empotrada, kit de ducha, 1 salida adicional disponible, box empotrado incluido.

Встраиваемый термостатический смеситель, интегрированный душевой комплект + дополнительный выход воды, встраиваемый бокс

Articolo	Note	CROMO	BO-NO-NKO
8278		970,00	1.310,00

8279

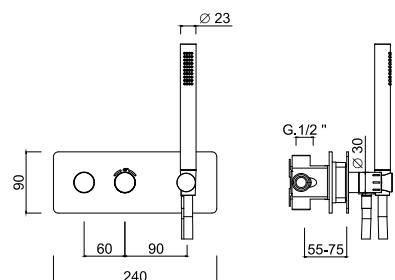
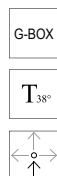

**Termostatico incasso, set doccia, 2 uscite libere, box incasso.**

Built-in thermostatic mixer, integrated shower set + 2 additional water outlets, built-in box.

Mitigeur thermostatique douche à encastrer, ensemble de douche + 2 sorties supplémentaires disponibles, box d'encastrement.

UP-Thermostat, integrierte Brauseset + 2 zusätzliche Verbraucher, inkl. Einbau Box.

Termostática empotrada, kit de ducha, 2 salidas adicionales disponibles, box empotrado incluido.

Встраиваемый термостатический смеситель, интегрированный душевой комплект + 2 дополнительных выхода воды, встраиваемый бокс

Articolo	Note	CROMO	BO-NO-NKO
8279		1.025,00	1.384,00

1707-20

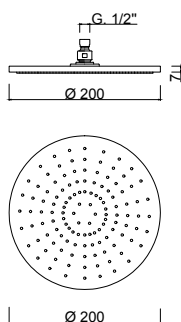

**Soffione doccia anticalcare Ø 200. Ottone**

Shower head, anti limestone, Ø 200 mm. In brass.

Pomme de douche anticalcaire Ø 200 mm. En laiton.

Kopfbräuse, Antikalk System, Ø 200 mm. In Messing.

Rociador antical Ø 200 mm, en latón.

Верхний душ, защита от известняка, Ø 200 мм, латунь.

Articolo	Note	CROMO	BO-NO-NKO
1707-20	mm 200	176,00	425,00
1707-25	mm 250	286,00	405,00
1707-30	mm 300	341,00	•

1710-20

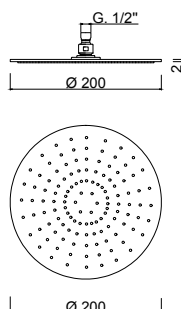

**Soffione doccia anticalcare Ø 200. Inox**

200 mm diameter shower head, anti limestone. Stainless steel.

Pomme de douche anticalcaire Ø 200 mm. Inox.

Kopfbräuse, Antikalk System Ø 200 mm. Inox.

Rociador antical Ø 200 mm. Inoxidable.

Верхний душ Ø 200 мм, защита от известняка, нержавеющая сталь.

Articolo	Note	CROMO	BO-NO-NKO
1710-20	mm 200	121,00	•
1710-25	mm 250	171,00	•
1710-30	mm 300	226,00	•
1710-40	mm 400	358,00	•

1751-35

**Braccio doccia in ottone da mm 350.**  
Brass shower arm, length mm 350.  
Bras de douche, laiton chromé, longueur mm 350.  
Wandarm, mm 350 Länge, verchromtes Messing.  
Brazo ducha largo 350 mm, latón cromado.  
Душевой кронштейн из латуни, длина 350 мм.

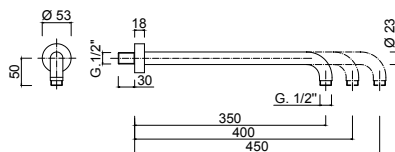

Articolo	Note	CROMO	BO-NO-NKO		
1751-35	mm 350	78,00	121,00		
1751-40	mm 400	83,00	•		
1751-45	mm 450	98,00	•		

1762-10

**Braccio doccia da soffitto mm.100.**  
Ceiling shower arm mm 100.  
Bras de douche vertical mm 100.  
Brausearm für Deckenmontage mm 100.  
Brazo de ducha a techo mm 100.  
Держатель душа 100 мм, потолочный

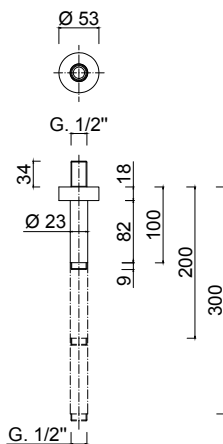

Articolo	Note	CROMO	BO-NO-NKO		
1762-10	mm 100	52,00	78,00		
1762-20	mm 200	61,00	•		
1762-30	mm 300	70,00	•		

1614

**Soffione inox incasso Ø 550, con getto pioggia, 6 nebulizzatori, sistema di cromoterapia 7 colori con comando remoto touch wireless**

Inox stainless steel ceiling-mounted showerhead Ø 550 with rain flow, 6 spray jets, 7-colours LED lights for chromotherapy with touch screen wireless remote-control.

Ciel de pluie en acier inox Ø 550 avec jet à pluie, 6 jets d'eau brumisée, LED pour la chromothérapie en 7 couleurs avec télécommande à l'écran tactile sans fils.

Edelstahl Kopfbrause Ø 550 mit Regendusche, 6 Wasserstrahlen Spray, LED Farbtherapie in 7 Farben mit Touch Screen kabelloser Fernbedienung.

Rociador a techo inox Ø 550 con chorro lluvia, 6 chorros de agua pulverizada, LED luz cromoterapia en 7 colores con control remoto touch screen sin cables.

Верхний душ Ø 550 потолочного монтажа из нержавеющей стали с функцией дождя, 6 распылительных форсунок, функция хромотерапии с 7 LED цветами, регулируемая посредством дистанционного сенсорного пульта.

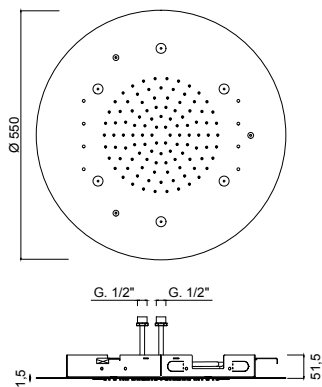

Articolo	Note	CROMO	BO-NO-NKO		
1614		2.315,00	•		

1615

**Soffione inox incasso Ø 550, con getto pioggia, 6 nebulizzatori**

Stainless steel shower head inox Ø 550, with rain flow, 6 spray jets.  
Ciel de pluie en acier inox Ø 550 avec jet à pluie, 6 jets d'eau brumisée.

Edelstahl Kopfbrause Ø 550 mit Regendusche, 6 Wasserstrahlen Spray.

Rociador a techo inox Ø 550 con chorro lluvia, 6 chorros de agua pulverizada.

Верхний душ Ø 550 из нержавеющей стали с функцией дождя, 6 распылительных форсунок.

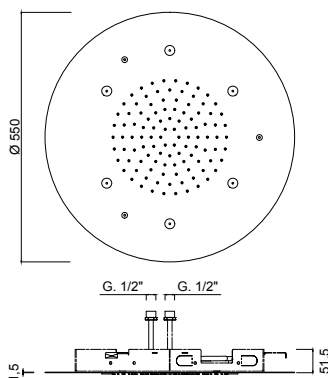

Articolo	Note	CROMO	BO-NO-NKO		
1615		1.155,00	•		



1726-50

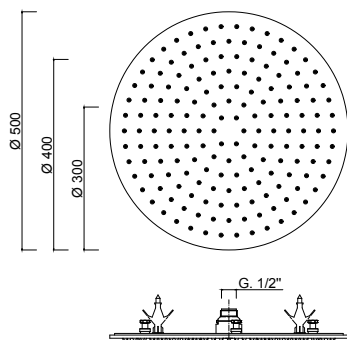

**Soffione inox incasso Ø 500, con getto pioggia.**

*Ceiling-mounted stainless steel shower head Ø 500, with rainfall jet.  
Ciel de pluie à encastrer au plafond en acier inox Ø 500 avec jet à pluie.*

*Kopfbrause Inox für Deckeneinbau Ø 500, mit Regenstrahl.*

*Rociador Inox de techo empotrado Ø 500, con chorro lluvia.*

*Верхний душ Ø 500 из нержавеющей стали с функцией дождя.*

Articolo	Note	CROMO	BO-NO-NKO		
1726-50	mm 500	1.070,00	1.436,00		
1726-40	mm 400	820,00	1.139,00		
1726-30	mm 300	670,00	935,00		

1739

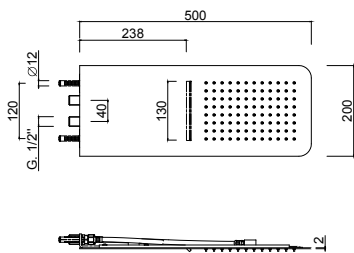

**Soffione a parete, getto pioggia, getto cascata.**

*Wall-mounted showerhead with rainfall and waterfall jets.*

*Douche de tête mural avec jet pluie et cascade.*

*Kopfbrause für Wandmontage mit Regen- und Wasserfalldusche.*

*Rociador ducha a pared, chorro lluvia, cascada.*

*Верхний душ настенного монтажа с функциями дождя и водопада*

Articolo	Note	CROMO	BO-NO-NKO		
1739		595,00	•		

1740

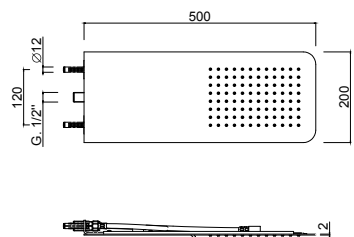

**Soffione a parete, getto pioggia.**

*Wall-mounted showerhead with rainfall jet.*

*Douche de tête mural avec jet pluie.*

*Kopfbrause für Wandmontage mit Regendusche.*

*Rociador ducha a pared, chorro lluvia.*

*Верхний душ настенного монтажа с функцией дождя*

Articolo	Note	CROMO	BO-NO-NKO		
1740		450,00	•		

1743-B

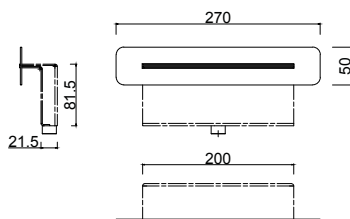

**Bocca incasso, getto cascata.**

*Built-in waterfall spout.*

*Bec à encastrer avec jet cascade.*

*UP-Wasserfall-Auslauf.*

*Caño empotrado, chorro cascada.*

*Встраиваемый каскадный излив*

Articolo	Note	CROMO	BO-NO-NKO		
1743-B		388,00	•		

1625

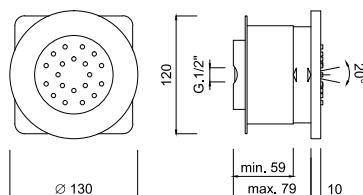

**Soffioncino orientabile laterale incasso**

*Built-in adjustable lateral body spray.*

*Douchette latérale murale orientable.*

*Verstellbare UP-Seitenkörperbrause.*

*Ducha lateral de pared ajustable.*

*Встроенная регулируемая боковая форсунка.*

Articolo	Note	CROMO	BO-NO-NKO		
1625		110,00	•		

1626

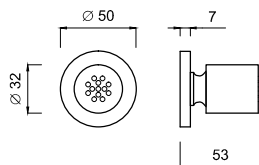

**Soffioncino orientabile laterale esterno**

External adjustable lateral body spray.  
Douchette latérale extérieure orientable.  
Externe verstellbare Seitenkörperbrause.  
Ducha lateral externa ajustable.  
Боковая регулируемая форсунка наружного монтажа.

Articolo	Note	CROMO	BO-NO-NKO		
1626		35,00	•		

1545

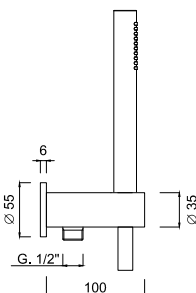

**Kit duplex incasso Futuro.**

Built-in duplex shower kit Futuro.  
Ensemble de douche duplex à encaissement Futuro.  
Einbaubrauseset Duplex Futuro.  
Conjunto de ducha duplex para empotrar Futuro.  
встроенный душевой набор "Duplex" Futuro.

Articolo	Note	CROMO	BO-NO-NKO		
1545		84,00	219,00		

1632

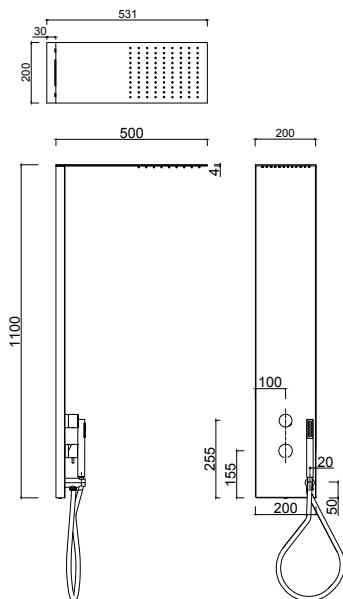

**Colonna doccia esterna con monocomando, soffione pioggia, set doccia.**

Wall-mounted shower column with mixer, rainfall jet and duplex shower kit.  
Colonne de douche complète avec mitigeur, ciel de pluie et ensemble de douche.  
AP-Duschsäule mit Einhebelmischer, Regendusche und Brauseset.  
Columna de ducha de superficie con monomando, rociador chorro lluvia, kit de ducha.  
Настенная душевая колонна со смесителем, верхним душем с функцией дождя и душевым комплектом "duplex"

Articolo	Note	CROMO	BO-NO-NKO		
1632		950,00	1.650,00		

6508-01WS

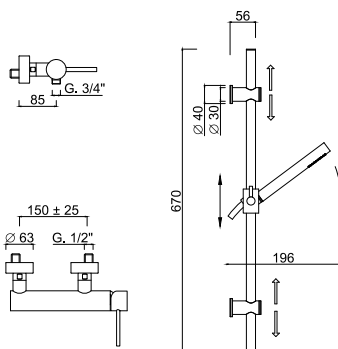

**Monocomando doccia esterna con saliscendi e doccia.**

External single-lever shower mixer with sliding rail set.  
Mitigeur extérieur de douche avec barre coulissante et ensemble de douche.  
Aufputz- Einhand-Brausebatterie mit Brausestange und Brauseset.  
Monomando ducha exterior con conjunto de ducha y barra deslizante.  
Однорычажный смеситель внешнего монтажа для душа с комплектом штанги для душа.

Articolo	Note	CROMO	BO-NO-NKO		
6508-01WS		372,00	672,00		

**6508SWC-S**

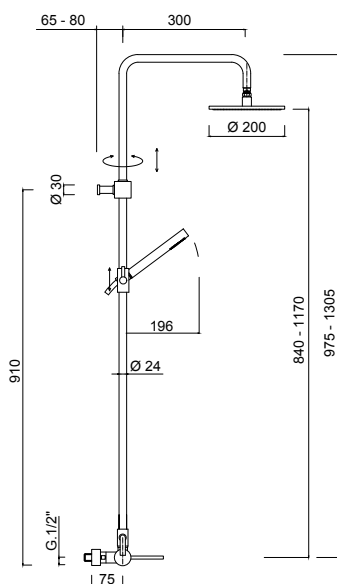

**Colonna doccia esterna monocomando, set doccia, soffione in ottone**

External single-lever shower mixer with shower column, shower kit, brass shower head.

Mitigeur de douche avec colonne de douche, ensemble de douche, pomme de douche en laiton.

Brausemischer mit Säulenbrause, Brauseset, Kopfbrause in Messing. Monomando con columna para ducha, conjunto de ducha, rociador en latón.

Однорычажный смеситель для душа внешнего монтажа с душевой колонной, душевой набор, верхний душ из латуни

Articolo	Note	CROMO	BO-NO-NKO		
<b>6508SWC-S</b>		835,00	1.417,00		

**8310-20**

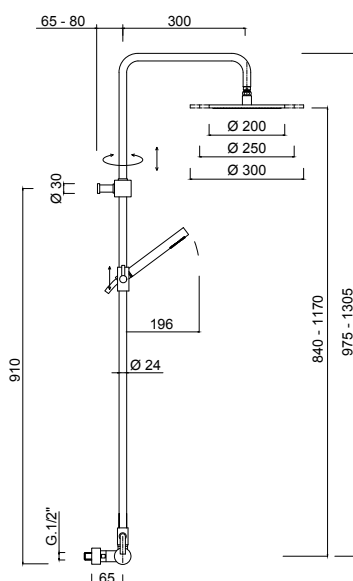

**Colonna doccia esterna termostatica, set doccia, soffione in ottone**

External thermostatic shower column, shower kit, brass shower head. Colonne de douche avec mitigeur thermostatique, ensemble de douche, pomme de douche en laiton.

Aufputz- Standbrause mit Thermostat-Brausebatterie, Brauseset, Kopfbrause in Messing.

Columna ducha con mezclador termostático, conjunto de ducha, rociador ducha en latón.

Термостатическая душевая колонна внешнего монтажа, душевой набор, верхний душ из латуни.

Articolo	Note	CROMO	BO-NO-NKO		
<b>8310-20</b>	mm 200	883,00	•		
<b>8310-25</b>	mm 250	933,00	•		
<b>8310-30</b>	mm 300	988,00	•		



8311-20

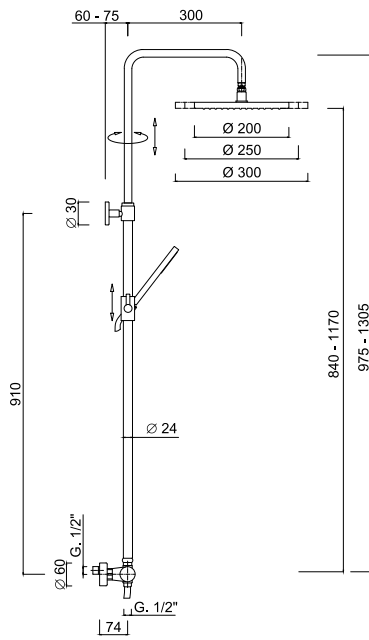

**Colonna doccia esterna monocomando, set doccia, soffione in ottone**

External single-lever shower mixer with shower column, shower kit, brass shower head.

Colonne de douche avec mitigeur thermostatique, ensemble de douche, pomme de douche en laiton.

Brausemischer mit Säulenbrause, Brauseset, Kopfbrause in Messing. Monomando con columna para ducha, conjunto de ducha, rociador en latón.

Однорычажный смеситель для душа внешнего монтажа с душевой колонной, душевой набор, верхний душ из латуни

Articolo	Note	CROMO	BO-NO-NKO		
8311-20	mm 200	842,00	•		
8311-25	mm 250	892,00	•		
8311-30	mm 300	947,00	•		

6508

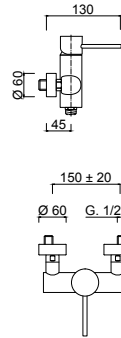

**Monocomando doccia esterno**

External single-lever shower mixer.

Mitigeur pour douche externe.

Aufputz- Einhebelbatterie.

Monomando ducha externo.

Однорычажный смеситель внешнего монтажа для душа.

Articolo	Note	CROMO	BO-NO-NKO		
6508		178,00	•		

6508-01

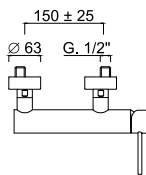
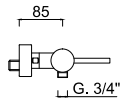

**Monocomando doccia esterno**

External single-lever shower mixer.

Mitigeur pour douche externe.

Aufputz- Einhebelbatterie.

Monomando ducha externo.

Однорычажный смеситель внешнего монтажа для душа.

Articolo	Note	CROMO	BO-NO-NKO		
6508-01		231,00	312,00		

6508S

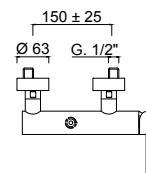
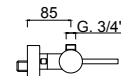

**Monocomando doccia esterno (attacco superiore)**

External single-lever shower mixer (upper connection).

Mitigeur douche (connection supérieure).

Aufputz- Brausemischer (oberer Anschluss).

Misturador para ducha (conexion superior).

Однорычажный смеситель для душа внешнего монтажа (подключение сверху)

Articolo	Note	CROMO	BO-NO-NKO		
6508S		231,00	312,00		

**8208EX**



T<sub>38°</sub>

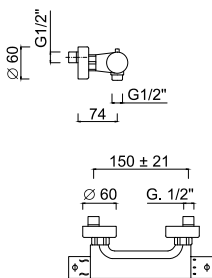

**Termostatico doccia esterno attacco da ½**  
External thermostatic shower mixer with ½ connection.  
Mitigeur thermostatique pour douche ½.  
Thermostat-Brausebatterie ½.  
Mezclador termostático externo ducha ½.  
Термостатический смеситель внешнего монтажа с соединением 1/2\".

Articolo	Note	CROMO	BO-NO-NKO		
8208EX		255,00	•		

**8221EX**



T<sub>38°</sub>

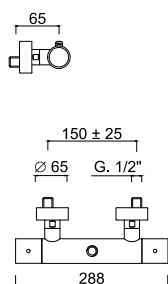

**Miscelatore termostatico doccia esterno Uscita superiore.**  
External shower thermostatic mixer with upper connection.  
Mélangeur thermostatique pour douche avec connexion supérieure.  
Thermostat-Brausebatterie mit oberen Anschluss.  
Mezclador termostático externo ducha con conexión superior.  
Термостатический смеситель для внешнего душа с верхним соединением.

Articolo	Note	CROMO	BO-NO-NKO		
8221EX		370,00	•		

**6501-01**

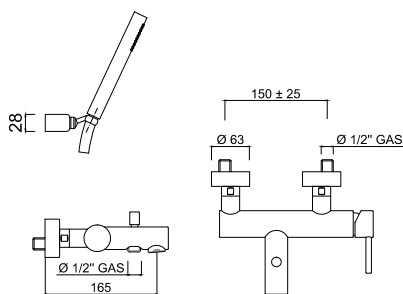

**Monocomando vasca esterno con set doccia duplex.**  
External bathtub single-lever mixer with duplex shower kit.  
Mitigeur bain/douche extérieur avec ensemble de douche duplex.  
Aufputz- Einhebelmischer für die Badewanne mit Brauset set Duplex.  
Monomando bañera externo con conjunto de ducha duplex.  
Однорычажный смеситель внешнего монтажа для ванны с душевым набором "Duplex"

Articolo	Note	CROMO	BO-NO-NKO		
6501-01		352,00	580,00		

**6501**

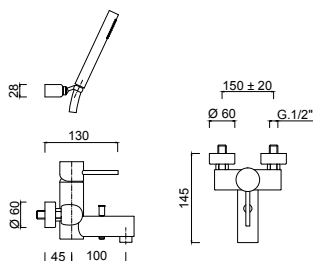

**Monocomando vasca esterno con set doccia duplex.**  
External bathtub single-lever mixer with duplex shower kit.  
Mitigeur bain/douche extérieur avec ensemble de douche duplex.  
Aufputz- Einhebelmischer für die Badewanne mit Brauset set Duplex.  
Monomando bañera externo con conjunto de ducha duplex.  
Однорычажный смеситель внешнего монтажа для ванны с душевым набором "Duplex"

Articolo	Note	CROMO	BO-NO-NKO		
6501		330,00	•		

**6503**

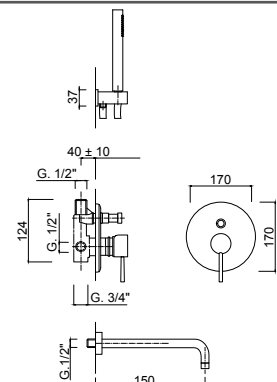
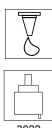

**Monocomando vasca incasso, kit duplex incasso, bocca mm.150.**  
Built-in bath mixer, duplex shower kit, spout mm 150.  
Mitigeur bain-douche à encastrer, ensemble de douche à encastrer, bec mm 150.  
UP-Einhebel-Wannenmischer, UP-Brauset set, Auslauf mm 150.  
Monomando bañera empotrado, kit de ducha empotrado, caño mm 150.  
Встраиваемый смеситель для ванны, душевой набор "Duplex", излив 150 мм.

Articolo	Note	CROMO	BO-NO-NKO		
6503		333,00	500,00		

6565BD

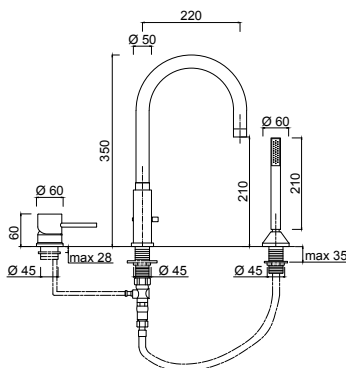

**Monocomando bordo vasca 3 fori, bocca con deviatore**  
3-hole single-lever mixer deck-mounted for bath's border, spout with diverter.  
Mélangeur à 3 trous, bec avec déviateur.  
3-Loch Wannenmischer, Auslauf mit Umstellung.  
Monomando baño sobre repisa, caño con desviación.  
Однорычажный смеситель на 3 отверстия на борту ванны, излив с дивертером.

Articolo	Note	CROMO	BO-NO-NKO		
6565BD		430,00	645,00		

6592

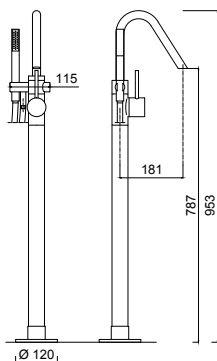

**Monocomando vasca a pavimento (con scatola incasso)**  
Free-standing bath mixer (with built-in box).  
Mélangeur baignoire à terre (avec la boîte murale).  
Wannenmischer mit Standfuß Schlauch (mit Montagedose auf dem Boden).  
Monomando bañera a pavimento (con caja de montaje en el suelo).  
Свободно-стоящий смеситель для ванны (со встраиваемой коробкой).

Articolo	Note	CROMO	BO-NO-NKO		
6592		1.599,00	2.160,00		

5102L

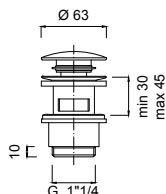

**Scarico per lavabo Up&Down 1"1/4.**  
Basin drain 1"1/4 Up&Down.  
Vidage lavabo Up&Down 1"1/4.  
Ablaufgarnitur Up&Down 1"1/4.  
Desague automatico Up&Down 1"1/4.  
Слив для раковины Up&Down 1"1/4

Articolo	Note	CROMO	BO-NO-NKO		
5102L		45,00	63,00		

5109L

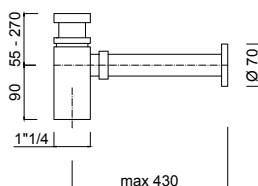

**Sifone per Lavabo 1"1/4.**  
Trap for basin 1"1/4.  
Siphon lavabo 1"1/4.  
Röhrensifon Waschtsch 1"1/4.  
Sifón para lavabo 1"1/4.  
Сифон для раковины 1"1/4

Articolo	Note	CROMO	BO-NO-NKO		
5109L		87,00	126,00		

3264L

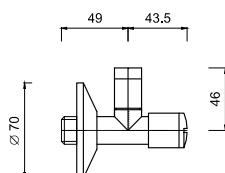

**Rubinetto sottolavabo con filterstop.**  
Under-sink valve with filterstop.  
Coude sous lavabo avec filterstop.  
Eckventile mit Filter.  
Llave de paso para lavabo con filterstop.  
Вентиль под раковину с filterstop

Articolo	Note	CROMO	BO-NO-NKO		
3264L		48,00	70,00		

1782

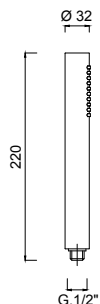

**Doccetta monogetto ottone**  
Brass single-jet hand-shower.  
Douchette 1 jet en laiton.  
Handbrause Messing 1 Strahlart.  
Ducha de mano de latón 1 chorro.  
одноструйный душ из латуни

Articolo	Note	CROMO	BO-NO-NKO		
1782		38,00	98,00		
3215Q	ABS	15,00			

1780

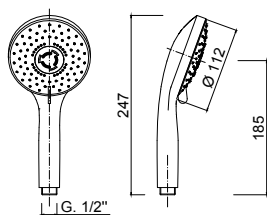

**Doccetta anticalcare idromassaggio .**  
3 jets, anti-limestone handshower.  
Douchette 3-jets, anticalcaire.  
3 Strahlarten, Antikalk-System.  
Ducha 3 posiciones, antical.  
Гидромассажная лейка с защитой от известняка .

Articolo	Note	CROMO	BO-NO-NKO		
1780		30,00	•		

1536

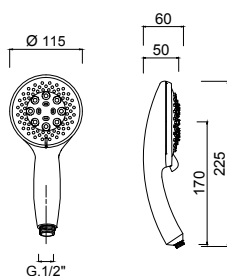

**Doccetta 5 getti a disco**  
Hand-shower 5 jets disc.  
Douchette à 5 jets à disque.  
5-Jets Handbrause.  
Ducha 5 posiciones.  
Круглая пятиструйная душевая лейка.

Articolo	Note	CROMO	BO-NO-NKO		
1536		71,00	•		

1669

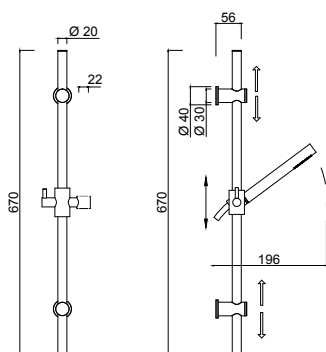

**Saliscendi in ottone con doccia monogetto Futuro.**  
Brass sliding bar and Futuro 1 jet handshower.  
Barre de douche en laiton avec douchette 1 jet Futuro.  
Brausestange in Messing mit Handbrause 1 Strahl Futuro.  
Barra deslizante en latón con ducha teléfono 1 chorro Futuro.  
Штанга для душа и ручной душ Futuro, один режим.

Articolo	Note	CROMO	BO-NO-NKO		
1669		149,00	378,00		

1671

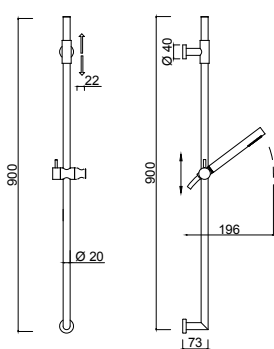

**Saliscendi con doccia Futuro. Allungabile**  
Adjustable sliding rail with Futuro hand-shower.  
Barre de douche extensible avec douchette Futuro.  
Verstellbare Brausestange mit Futuro-Handbrause.  
Barra deslizante extensible con ducha de mano Futuro.  
Регулируемая штанга с ручным душем Futuro. Раздвижная

Articolo	Note	CROMO	BO-NO-NKO		
1671		222,00	•		



1573

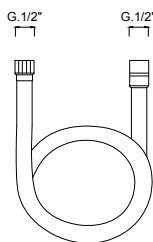

**Flessibile ottone doppia aggraffatura cm.150 CC.**  
Flexible brass hose cm. 150 doubleinterlock.  
Flexible laiton double agrafage cm 150.  
Messing-Brauseschlauch cm150.  
Flexible latòn doble grapado cm 150.  
Гибкий шланг 150 см с двойным зажимом

Articolo	Note	CROMO	BO-NO-NKO		
1573		16,00	•		

1730

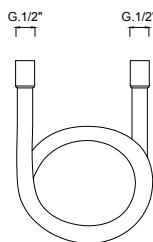

**Flessibile girevole cm.150 in PVC**  
PVC fl exible, cm.150.  
Flexible en PVC, cm.150.  
PVC Brauseschlauch, cm.150.  
Tubo fl exible en PVC, cm.150.  
Гибкий шланг, 150 см.

Articolo	Note	CROMO	BO-NO-NKO		
1730		28,00	28,00		

1510CL

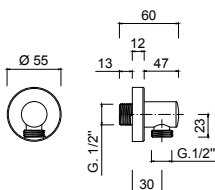

**Presca acqua 1/2".**  
Water plug 1/2".  
Prise d'eau mural 1/2".  
Wandanschlussbogen 1/2" für Brauseanschl.。  
Toma de agua 1/2".  
Крепление к стене для гибкого шланга.

Articolo	Note	CROMO	BO-NO-NKO		
1510CL		25,00	48,00		

3252-13



**Kit prolunga (mm.130). Specificare per quale articolo.**  
Kit long extension (mm.130). Specify for which item.  
Kit rallonge (mm.130). Spécifier pour quel article.  
Kit verlängerung (mm.130). Für welche Artikelnummer nennen.  
Kit alargador (mm.130). Especificquen la referencia.  
Комплект долго расширение (mm.130). Уточнить, для какого артикула

Articolo	Note	CROMO	BO-NO-NKO		
3252-13		88,00	•		

## NOTE

**Potete trovare altre soluzioni per la Doccia nell'area WELLNESS.** p.374  
For additional Shower options please go to WELLNESS section.  
Pour plus de solutions pour la Douche visitez la section WELLNESS.  
Für weitere Duschalternativen sehen Sie bitte in dem Kapitel WELLNESS nach.  
Para más soluciones para Ducha visite la sección WELLNESS.  
Другие решения для Душа вы найдете в разделе Wellness.

**Per gli Accessori Bagno abbinati alla serie potete consultare la serie MODERNA.** p.446  
For matching Bathroom Fittings please check MODERNA line.  
Pour les Accessoires Salle de Bains coordonnés à la collection visitez la ligne MODERNA.  
Die zu der Serie passenden Bad-Accessoires finden Sie in dem Linie MODERNA.  
Para los Accesorios de Baño compatibles con la serie visite la línea MODERNA.  
Чтобы подобрать подходящие аксессуары для ванной комнаты, перейдите в Линия MODERNA

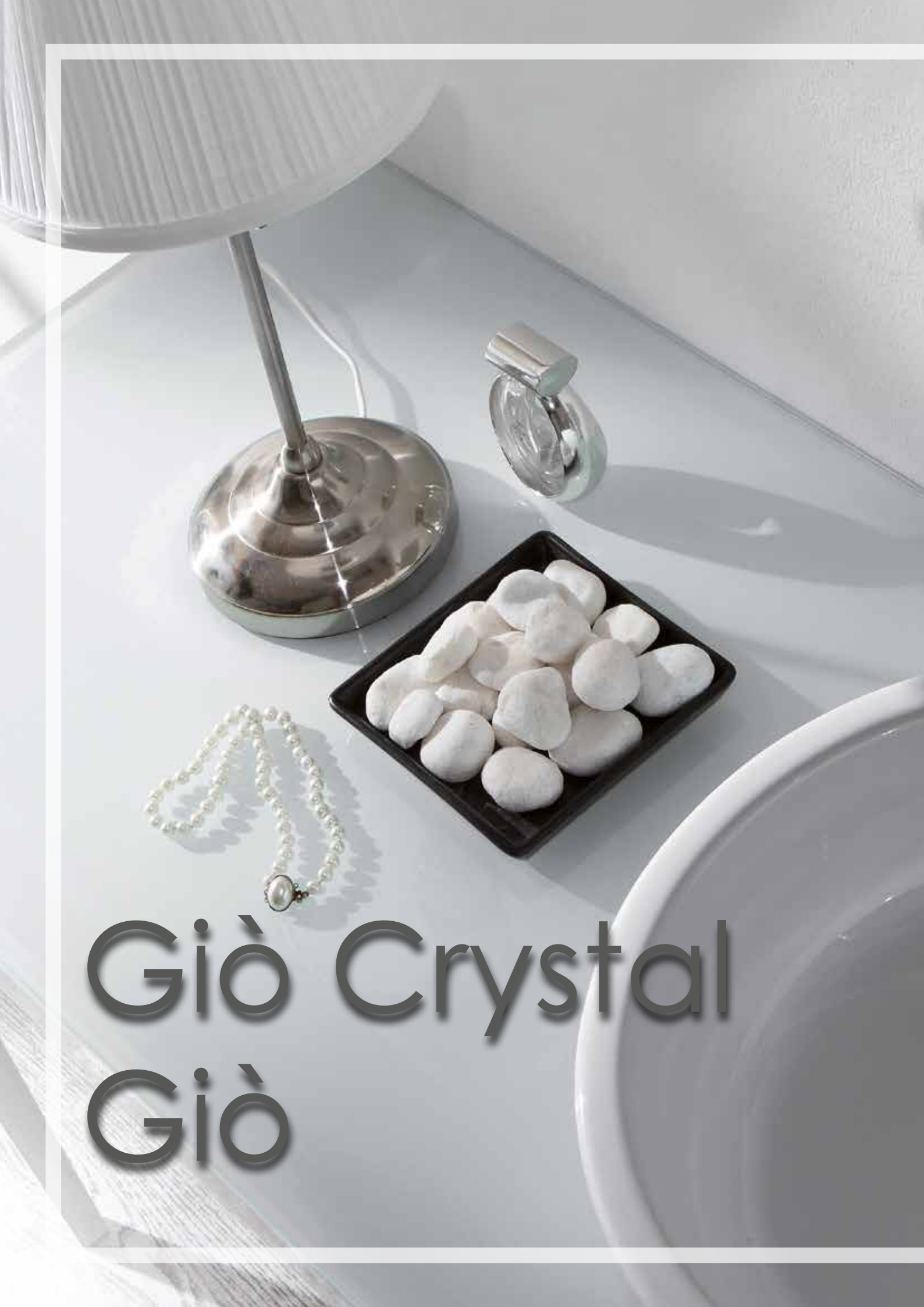

Giò Crystal  
Giò

Crystals from Swarovski®











### 3612A/S

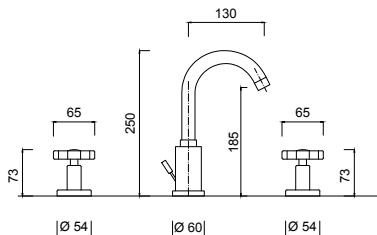

**Batteria lavabo 3 fori, bocca girevole, scarico 1"1/4**  
3-hole wash-basin set, swivel spout, 1"1/4 pop-up waste.  
Mélangeur lavabo à trois trous, bec mobile, vidage automatique 1"1/4.  
Waschtisch-Dreilochbatterie, Schwenkbarer Rohrauslauf, Ablaufgarnitur 1"1/4.  
Batería lavabo con 3 agujeros, caño giratorio, tapón accionado por varilla 1"1/4.  
Комплект для раковины на 3 отверстия, поворотный излив, донный клапан 1"1/4.

Articolo	Note	CROMO	BO-NO-NKO	BR
3612A/S		372,00	540,00	558,00
3612A	G	352,00	520,00	538,00

### 3657A/S

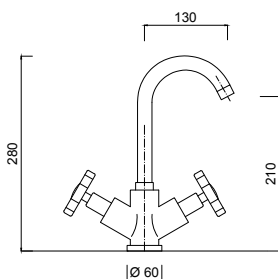

**Monoforo lavabo, bocca girevole, scarico 1"1/4 (con flessibile).**  
Wash-basin unit, swivel spout, 1"1/4 pop-up waste (with flexible).  
Mélangeur monotrou lavabo, bec mobile, vidage automatique 1"1/4 (avec flex.)  
Waschtisch-Einlochbatterie, Schwenkbarer Rohrauslauf, Ablaufgarnitur 1"1/4 (mit flexiblen Anschlusschläuchen).  
Monobloque lavabo, caño giratorio, tapón accionado por varilla 1"1/4 (con flexible).  
Смеситель для раковины, поворотный излив, донный клапан 1"1/4 (гибкая подводка).

Articolo	Note	CROMO	BO-NO-NKO	BR
3657A/S		335,00	486,00	503,00
3657A	G	315,00	466,00	483,00

### 3505A/S

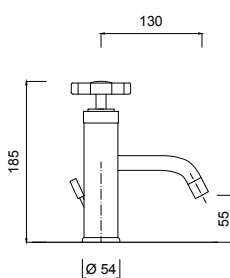

**Monocomando lavabo, scarico 1"1/4 (con flessibile).**  
Wash-basin single-lever mixer, 1"1/4 pop-up waste (with flexible).  
Mitigeur lavabo avec vidage 1"1/4 (avec flexible).  
Einhand-Waschtischbatterie mit Ablaufgarnitur 1"1/4 (mit flexiblen Anschlusschläuchen).  
Monomando lavabo tapón accionado por varilla 1"1/4 (con flexible).  
Однорычажный смеситель для раковины, донный клапан 1"1/4 (гибкая подводка).

Articolo	Note	CROMO	BO-NO-NKO	BR
3505A/S		250,00	•	•
3505A	G	240,00	•	•

### 3539A/S

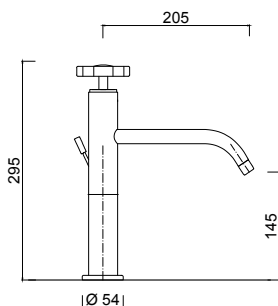

**Monocomando lavabo con prolunga, bocca lunga, scarico 1"1/4 (con flessibile)**  
High wash-basin single-lever mixer with long spout, 1"1/4 pop-up waste (with flex.).  
Mitigeur lavabo haut avec bec long, avec vidage 1"1/4 (avec flexible).  
Einhand-Waschtischbatterie mit hohem und langem Auslauf, mit Ablaufgarnitur 1"1/4 (mit flexiblen Anschlusschläuchen).  
Monomando lavabo alto con caño longo, tapón accionado por varilla 1"1/4 (con flex.).  
Высокий однорычажный смеситель для раковины с удлиненным изливом, донный клапан 1"1/4 (гибкая подводка).

Articolo	Note	CROMO	BO-NO-NKO	BR
3539A/S		330,00	479,00	495,00
3539A	G	320,00	469,00	485,00



### 3620-25/S

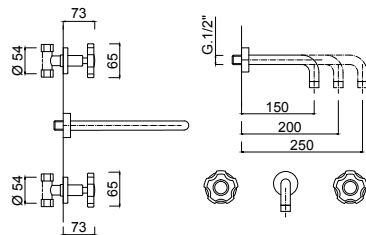

**Lavabo 3 fori a muro, bocca mm.250, senza scarico.**  
Wall-mounted 3-hole wash-basin set, spout mm 250, without pop-up waste.  
Mélangeur lavabo mural 3 trous, bec mm 250, sans vidage.  
3-Loch Waschtischarmatur für die Wandmontage, Auslauf mm 250, ohne Ablaufgarnitur.  
Bimando lavabo mural 3 agujeros, caño mm 250, sin desagüe automático.  
Комплект для раковины на 3 отверстия настенного монтажа, излив 250 мм., без донного клапана

Articolo	Note	CROMO	BO-NO-NKO	BR
3620-25/S	mm 250	295,00	428,00	443,00
3620-20/S	mm 200	295,00	428,00	443,00
3620-15/S	mm 150	295,00	428,00	443,00
3620-25	mm 250	275,00	408,00	423,00
3620-20	mm 200	275,00	408,00	423,00
3620-15	mm 150	275,00	408,00	423,00

### 3623-25/S

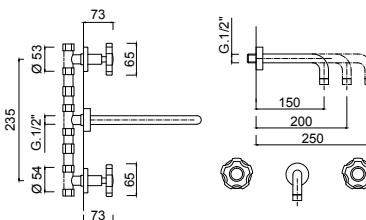

**Lavabo 3 fori a muro, bocca mm.250, senza scarico (con connessioni).**  
Wall-mounted 3-hole wash-basin set, spout mm 250, without pop-up waste (with connections).  
Mélangeur lavabo mural 3 trous, bec mm 250, sans vidage (avec raccords).  
3-Loch Waschtischarmatur für die Wandmontage, Auslauf mm 250, ohne Ablaufgarnitur (mit Anschlüssen).  
Bimando lavabo mural 3 agujeros, caño mm 250, sin desagüe automático (con conexiones).  
Комплект для раковины на 3 отверстия настенного монтажа, излив 250 мм., без донного клапана (со встроенной частью)

Articolo	Note	CROMO	BO-NO-NKO	BR
3623-25/S	mm 250	336,00	469,00	484,00
3623-20/S	mm 250	336,00	469,00	484,00
3623-15/S	mm 150	336,00	469,00	484,00
3623-25	mm 250	316,00	449,00	464,00
3623-20	mm 200	316,00	449,00	464,00
3623-15	mm 150	316,00	449,00	464,00

### 3613A/S

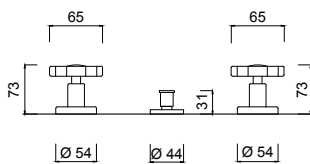

**Batteria bidet 3 fori, scarico 1"1/4.**  
3-hole bidet set, 1"1/4 pop-up waste.  
Mélangeur bidet 3 trous, vidage 1"1/4 (avec flexibles).  
3-Loch Bidetarmatur, Ablaufgarnitur 1"1/4.  
Grifo de bidé 3 agujeros, desagüe automático 1"1/4.  
Комплект для биде на 3 отверстия, донный клапан 1"1/4

Articolo	Note	CROMO	BO-NO-NKO	BR
3613A/S		275,00	399,00	413,00
3613A	G	255,00	379,00	393,00

### 3645A/S

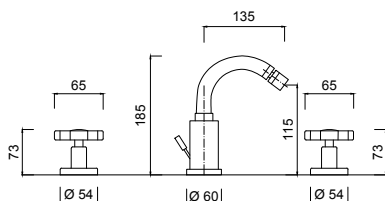

**Batteria bidet 3 fori, bocca girevole, scarico 1"1/4**  
3-hole bidet set, swivel spout, 1"1/4 pop-up waste.  
Mélangeur bidet à 3 trous, bec mobile, vidage automatique 1"1/4.  
Bidet-Dreilochbatterie, Schwenkbarer Rohrauslauf, Ablaufgarnitur 1"1/4.  
Bateria bidet, caño giratorio, tapón accionado por varilla 1"1/4.  
Комплект для биде на 3 отверстия, поворотный излив, донный клапан 1"1/4 (гибкая подводка).

Articolo	Note	CROMO	BO-NO-NKO	BR
3645A/S		359,00	520,00	539,00
3645A	G	339,00	500,00	519,00



### 3659A/S

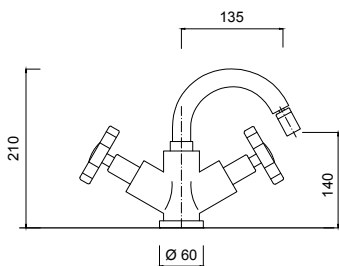

**Monoforo bidet, bocca girevole, scarico 1"1/4 (con flessibile)**  
 Bidet unit, swivel spout, 1"1/4 pop-up waste (with flexible).  
 Mélangeur monotrou bidet, bec mobile, vidage automatique 1"1/4 (avec flex.)  
 Bidet-Einlochbatterie, Schwenkbarer Rohrauslauf, Ablaufgarnitur 1"1/4 (mit flexiblen Anschlussschläuchen).  
 Monobloque bidet, caño giratorio, tapón accionado por varilla 1"1/4 (con flexible).  
 Смеситель для биде, поворотный излив, донный клапан 1"1/4 (гибкая подводка).

Articolo	Note	CROMO	BO-NO-NKO	BR
3659A/S		335,00	486,00	503,00
3659A	G	315,00	466,00	483,00

### 3507A/S

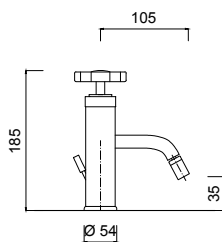

**Monocomando bidet, scarico 1"1/4 (con flessibile)**  
 Bidet single-lever mixer, 1"1/4 pop-up waste (with flexible).  
 Mitigeur bidet avec vidage 1"1/4 (avec flexible).  
 Einhand-Bidetbatterie mit Ablaufgarnitur 1"1/4 (mit flexiblen Anschlussschläuchen).  
 Monomando bidet, tapón accionado por varilla 1"1/4 (con flexible).  
 Однорычажный смеситель для биде, донный клапан 1"1/4 (гибкая подводка).

Articolo	Note	CROMO	BO-NO-NKO	BR
3607A/S		250,00	•	•
3607A	G	240,00	•	•

### 3615/S

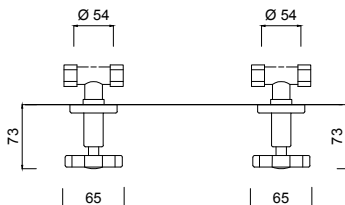

**Rubinetti incasso doccia**  
 Concealed shower taps.  
 Mélangeur douche encastré.  
 Unterputz-Brausebatterie.  
 Grupo ducha empotrar.  
 Встроенные краны для душа.

Articolo	Note	CROMO	BO-NO-NKO	BR
3615/S		207,00	300,00	310,00
3615	G	187,00	280,00	290,00

### 3515/S

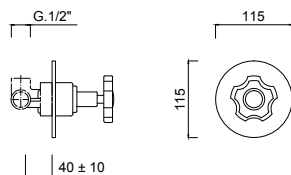

**Monocomando doccia incasso**  
 Shower built-in single-lever mixer.  
 Mitigeur pour douche à encaissement.  
 Unterputz-Duscheneinhebelmischer.  
 Monomando ducha para empotrar.  
 Однорычажный встроенный смеситель для душа.

Articolo	Note	CROMO	BO-NO-NKO	BR
3515/S		138,00	•	•
3515	G	128,00	•	•

### 3615W2/S

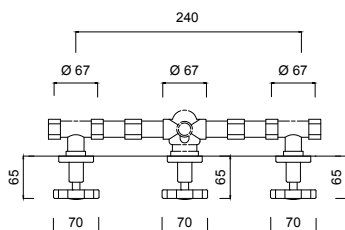
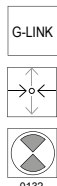

**Rubinetti incasso doccia e deviatore 2 uscite**  
 Concealed shower taps and 2 outlets diverter.  
 Mélangeur douche encastré et inverseur 2 sorties.  
 Unterputz-Brausebatterie mit 2-Ausgänge Umstellung.  
 Bimando ducha empotrad y desviador 2 salidas.  
 Встроенные краны для душа и дивертер на 2 выхода.

Articolo	Note	CROMO	BO-NO-NKO	BR
3615W2/S		452,00	585,00	610,00
3615W2	G	422,00	555,00	580,00

### 3513/S

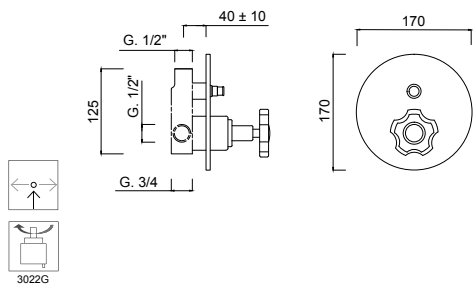

**Monocomando doccia incasso con deviatore.**  
Shower built-in single-lever mixer with diverter.  
Mitigeur pour douche à encaissement avec inverseur.  
Unterputz- Duscheneinhebelmischer mit Umstellung.  
Monomando ducha para empotrar con desviador.  
Однорычажный встроенный смеситель для душа с дивертером.

Articolo	Note	CROMO	BO-NO-NKO	BR
3513/S		231,00	•	•
3513	G	221,00	•	•

### 3607WS/S

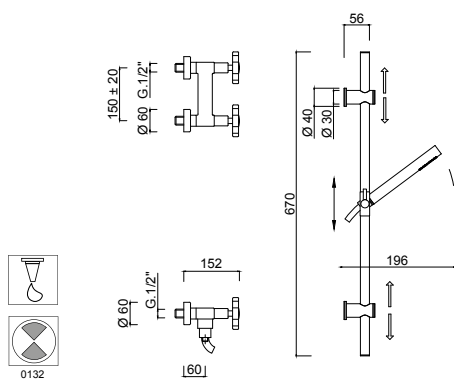

**Gruppo doccia esterno con saliscendi e doccia**  
External shower mixer with sliding rail set.  
mitigeur extérieur de douche avec barre coulissante et ensemble de douche.  
Aufputz-Brausebatterie mit Brausestange und Brauseset.  
Grupo ducha externo con conjunto ducha y barra deslizante.  
Смеситель для душа внешнего монтажа с комплектом штанги для душа.

Articolo	Note	CROMO	BO-NO-NKO	BR
3607WS/S		440,00	780,00	780,00
3607WS	G	420,00	760,00	760,00

### 3607WC-S/S

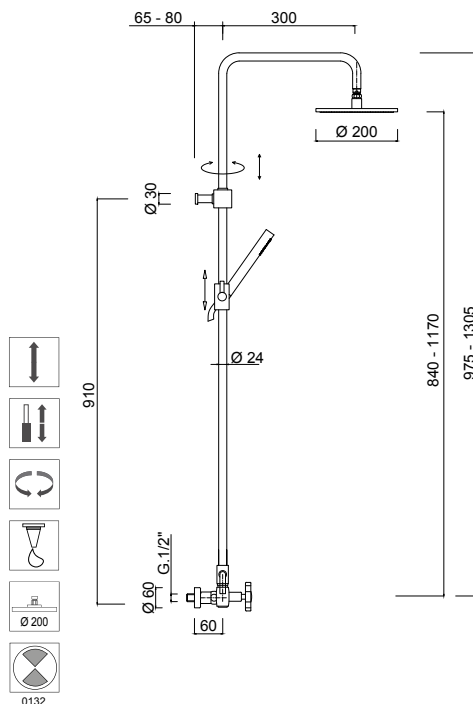

**Colonna doccia esterna, set doccia, soffione in ottone**  
External shower column, shower kit, brass shower head.  
Colonne de douche extérieure, ensemble de douche, pomme de douche en laiton.  
Aufputz-Standbrause, Brauseset, Kopfbrause in Messing.  
Columna ducha externa, conjunto de ducha, rociador en latón.  
Душевая колонна внешнего монтажа, душевой набор, верхний душ из латуни.

Articolo	Note	CROMO	BO-NO-NKO	BR
3607WC-S/S		820,00	1.367,00	•
3607WC-S	G	800,00	1.347,00	•

### 3607/S

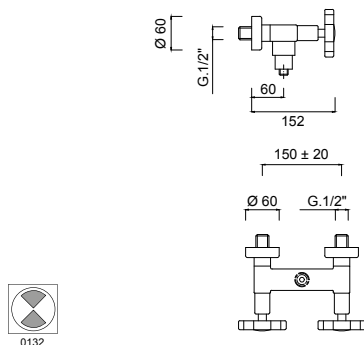

**Gruppo doccia esterno**  
External shower mixer.  
Mitigeur extérieur de douche.  
Aufputz- Brausebatterie.  
Mélangeur extérieur de douche.  
Смеситель для душа внешнего монтажа.

Articolo	Note	CROMO	BO-NO-NKO	BR
3607/S		298,00	432,00	447,00
3607	G	278,00	412,00	427,00

3508/S

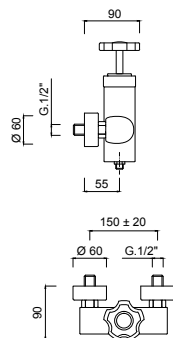

**Monocomando doccia esterno**  
External single-lever shower mixer.  
Mitigeur pour douche externe.  
Aufputz- Einhebelbatterie.  
Monomando ducha extemo.

Однорычажный смеситель внешнего монтажа для душа.

Articolo	Note	CROMO	BO-NO-NKO	BR
3508/S		267,00	•	•
3508	G	257,00	•	•

3601/S

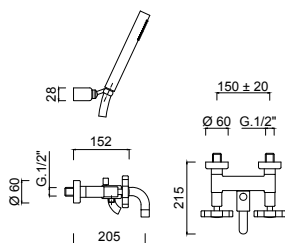

**Gruppo vasca esterno con set doccia duplex**  
External bathtub set with duplex shower kit.  
Mélangeur bain-douche extérieur avec ensemble de douche duplex.  
Wannenbatterie mit Schlauch-Handbrause und verstellbarem Wandhalter.

Grupo bañera externo con conjunto de ducha duplex.  
Комплект для ванны внешнего монтажа с душевым набором "Duplex".

Articolo	Note	CROMO	BO-NO-NKO	BR
3601/S		470,00	705,00	728,00
3601	G	450,00	685,00	708,00

3501/S

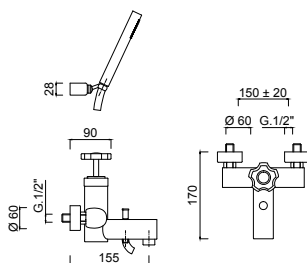

**Monocomando vasca esterno con set doccia duplex.**  
External bathtub single-lever mixer with duplex shower kit.  
Mitigeur bain/douche extérieur avec ensemble de douche duplex.  
Aufputz- Einhebelmischer für die Badewanne mit Brauseset Duplex.

Monomando bañera externo con conjunto de ducha duplex.  
Однорычажный смеситель внешнего монтажа для ванны с душевым набором "Duplex".

Articolo	Note	CROMO	BO-NO-NKO	BR
3501/S		401,00	•	•
3501	G	391,00	•	•

3660/S

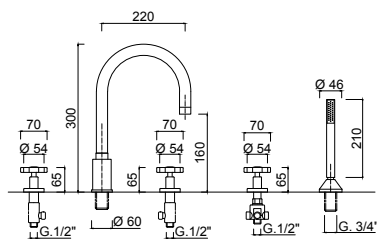

**Batteria bordo vasca 5 fori**  
5-hole bath border set.  
Mélangeur bain/douche sur gorge 5 trous.  
5-Loch Wannen Kombination.  
Bimando bañera de repisa 5 agujeros.  
Комплект на борт ванны на 5 отверстий.

Комплект на борт ванны на 5 отверстий.

Articolo	Note	CROMO	BO-NO-NKO	BR
3615W2/S		674,00	876,00	910,00
3615W2	G	644,00	846,00	880,00

**3665/S**

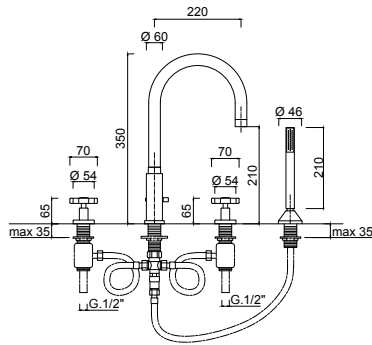

**Batteria bordo vasca 4 fori, bocca con deviatore.**

4-hole deck mounted set, spout with diverter.  
Mélangeur bain-douche sur gorge 4 trous, bec avec inverseur.  
4-Loch Wannenrandarmatur, Auslauf mit Umsteller.  
Grifo bañera de repisa 4 agujeros, caño con inversor.  
Комплект на 4 отверстия на край ванны, излив с дивертером

Articolo	Note	CROMO	BO-NO-NKO	BR	
<b>3665/S</b>		620,00	806,00	837,00	
<b>3665</b>	G	600,00	786,00	817,00	

**3616/S**

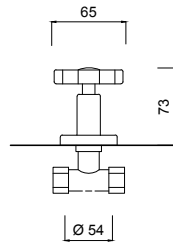

**Rubinetto incasso 1/2".**

1/2" built-in tap.  
Robinet d'arrêt à encastrer 3/4".  
UP-Absperrventil 3/4".  
Llave de paso a empotrar 3/4".  
Встраиваемый кран 1/2"

Articolo	Note	CROMO	BO-NO-NKO	BR	
<b>3616/S</b>		110,00	160,00	165,00	
<b>3616</b>	G	100,00	150,00	155,00	



**GIÒ**

**NOTE**

**Potete trovare altre soluzioni per la Doccia nell'area WELLNESS.** p.374  
For additional Shower options please go to WELLNESS section.  
Pour plus de solutions pour la Douche visitez la section WELLNESS.  
Für weitere Duschalternativen sehen Sie bitte in dem Kapitel WELLNESS nach.  
Para más soluciones para Ducha visite la sección WELLNESS.  
Другие решения для Душа вы найдете в разделе Wellness.

**Per gli Accessori Bagno abbinati alla serie potete consultare la serie MODERNA.** p.446  
For matching Bathroom Fittings please check MODERNA line.  
Pour les Accessoires Salle de Bains coordonnés à la collection visitez la ligne MODERNA.  
Die zu der Serie passenden Bad-Accessoires finden Sie in dem Linie MODERNA.  
Para los Accesorios de Baño compatibles con la serie visite la línea MODERNA.  
Чтобы подобрать подходящие аксессуары для ванной комнаты, перейдите в Линия MODERNA.



G3







**7612A**

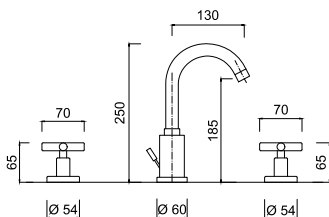

**Batteria lavabo 3 fori, bocca girevole, scarico 1"1/4**  
3-hole wash-basin set, swivel spout, 1"1/4 pop-up waste.  
Mélangeur lavabo à trois trous, bec mobile, vidage automatique 1"1/4.  
Waschtisch-Dreilochbatterie, Schwenkbarer Rohrauslauf, Ablaufgarnitur 1"1/4.  
Bateria lavabo con 3 agujeros, caño giratorio, tapón accionado por varilla 1"1/4.  
Комплект для раковины на 3 отверстия, поворотный излив, донный клапан 1"1/4.

Articolo	Note	CROMO	BO-NO-NKO
<b>7612A</b>		277,00	374,00

**7657A**

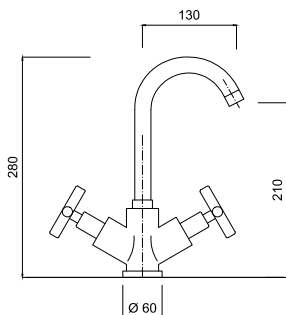

**Monoforo lavabo, bocca girevole, scarico 1"1/4 (con flessibile).**  
Wash-basin unit, swivel spout, 1"1/4 pop-up waste (with flexible).  
Mélangeur monotrou lavabo, bec mobile, vidage automatique 1"1/4 (avec flex.)  
Waschtisch-Einlochbatterie, Schwenkbarer Rohrauslauf, Ablaufgarnitur 1"1/4 (mit flexiblen Anschlussschläuchen).  
Monobloque lavabo, caño giratorio, tapón accionado por varilla 1"1/4 (con flexible).  
Смеситель для раковины, поворотный излив, донный клапан 1"1/4 (гибкая подводка).

Articolo	Note	CROMO	BO-NO-NKO
<b>7657A</b>		230,00	310,00

**7620-25**

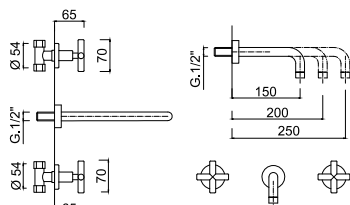

**Lavabo 3 fori a muro, bocca mm.250, senza scarico.**  
Wall-mounted 3-hole wash-basin set, spout mm 250, without pop-up waste.  
Mélangeur lavabo mural 3 trous, bec mm 250, sans vidage.  
3-Loch Waschtischarmatur für die Wandmontage, Auslauf mm 250, ohne Ablaufgarnitur.  
Bimando lavabo mural 3 agujeros, caño mm 250, sin desagüe automatico.  
Комплект для раковины на 3 отверстия настенного монтажа, излив 250 мм., без донного клапана

Articolo	Note	CROMO	BO-NO-BKO
<b>7620-25</b>	mm 250	199,00	269,00
<b>7620-20</b>	mm 200	199,00	269,00
<b>7620-15</b>	mm 150	199,00	269,00

**7623-25**

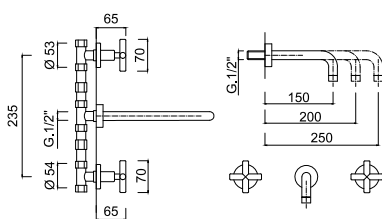

**Lavabo 3 fori a muro, mm250 (con connessioni).**  
3-hole wall mounted basin set, mm.250 (with connections).  
Mélangeur lavabo mural à 3 trous, mm.250 (avec les contacteurs).  
Waschtisch-Dreilochbatterie Wandmontage, mm.250 (mit Verbindungen).  
Lavabo de pared con 3 agujeros, mm.250 (con conexiones).  
Комплект настенного монтажа для раковины на 3 отверстия, mm.250 (с соединениями).

Articolo	Note	CROMO	BO-NO-BKO
<b>7623-25</b>	mm 250	250,00	338,00
<b>7623-20</b>	mm 200	250,00	338,00
<b>7623-15</b>	mm 150	250,00	338,00

**7613A**

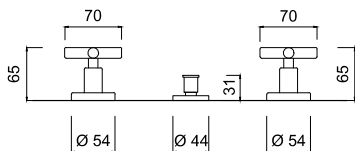

**Batteria bidet 3 fori, scarico 1"1/4.**  
3-hole bidet set, 1"1/4 pop-up waste.  
Mélangeur bidet 3 trous, vidage 1"1/4 (avec flexibles).  
3-Loch Bidetarmatur, Ablaufgarnitur 1"1/4.  
Grifo de bidé 3 agujeros, desagüe automatico 1"1/4.  
Комплект для биде на 3 отверстия, донный клапан 1"1/4

Articolo	Note	CROMO	BO-NO-NKO
<b>7613A</b>		170,00	246,00

**7645A**

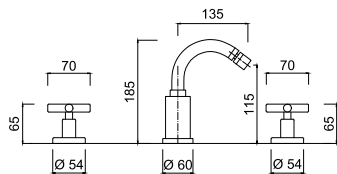

**Batteria bidet 3 fori, bocca girevole, scarico 1"1/4**

3-hole bidet set, swivel spout, 1"1/4 pop-up waste.  
Mélangeur bidet à 3 trous, bec mobile, vidage automatique 1"1/4.  
Bidet-Dreilochbatterie, Schwenkbarer Rohrauslauf, Ablaufgarnitur 1"1/4.  
Bateria bidet, caño giratorio, tapón accionado por varilla 1"1/4.  
Комплект для биде на 3 отверстия, поворотный излив, донный клапан 1"1/4 (гибкая подводка).

Articolo	Note	CROMO	BO-NO-NKO
<b>7645A</b>		274,00	397,00

**7659A**

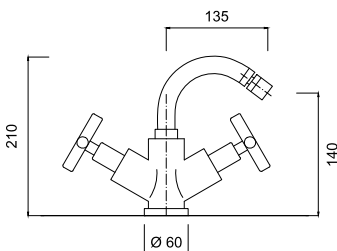

**Monoforo bidet, bocca girevole, scarico 1"1/4 (con flessibile)**

Bidet unit, swivel spout, 1"1/4 pop-up waste (with flexible).  
Mélangeur monotrou bidet, bec mobile, vidage automatique 1"1/4 (avec flex.).  
Bidet-Einlochbatterie, Schwenkbarer Rohrauslauf, Ablaufgarnitur 1"1/4 (mit flexiblen Anschlussschläuchen).  
Monobloque bidet, caño giratorio, tapón accionado por varilla 1"1/4 (con flexible).  
Смеситель для биде, поворотный излив, донный клапан 1"1/4 (гибкая подводка).

Articolo	Note	CROMO	BO-NO-NKO
<b>7659A</b>		230,00	310,00

**7615W2KS-25**

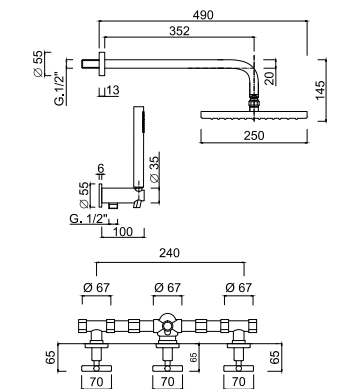

**Set doccia incasso con deviatore 2 vie, soffione ottone mm.250, kit duplex incasso.**

Built-in shower set with 2-way diverter, brass showerhead mm 250, duplex shower kit.  
Mélangeur douche à encastrer avec inverseur à 2 sorties, pomme de douche en laiton mm 250, ensemble de douche.  
UP-Brausearmatur mit 2-Wege-Umstellung, Kopfbrause aus Messing mm 250, UP-Brauseset.  
Bimando ducha empotrado con inversor 2 vías, rociador en latón mm 250, kit de ducha empotrado.  
Встраиваемый комплект для душа с дивертером на 2 выхода, верхний душ из латуны 250 мм, душевой набор "duplex"

Articolo	Note	CROMO	BO-NO-NKO
<b>7615W2KS-25</b>		736,00	1.172,00

**7615WB-25**

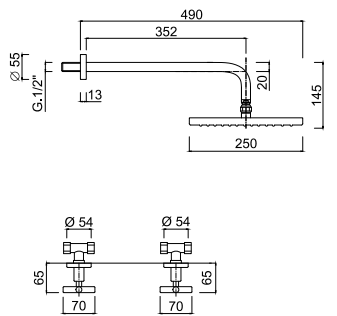

**Set doccia incasso, soffione in ottone mm.250.**

Built-in shower set, brass showerhead mm 250.  
Mitigeur douche à encastrer, pomme de douche en laiton mm 250.  
UP-Brausemischer mit Kopfbrause aus Messing mm 250.  
Bimando ducha empotrado, rociador en latón mm 250.  
Встраиваемый комплект для душа, верхний душ из латуны 250 мм

Articolo	Note	CROMO	BO-NO-NKO
<b>7615WB-25</b>		495,00	720,00

**7615W2**

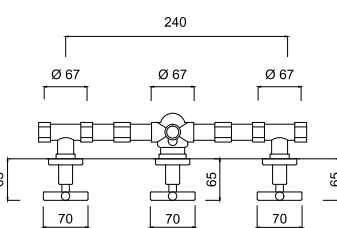
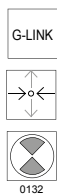

**Rubinetti incasso doccia e deviatore 2 uscite.**

Concealed shower taps and 2 outlets diverter.  
Mélangeur douche encastré et inverseur 2 sorties.  
Unterputz-Brausebatterie mit 2-Ausgänge Umstellung.  
Bimando ducha empotrado y desviador 2 salidas.  
Встроенные краны для душа и дивертер на 2 выхода

Articolo	Note	CROMO	BO-NO-NKO
<b>7615W2</b>		302,00	437,00

7615

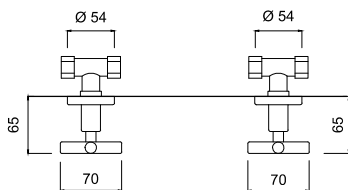

**Rubinetti incasso doccia**  
Concealed shower taps.  
Mélangeur douche encastré.  
Unterputz-Brausebatterie.  
Grupo ducha empotrar.  
Встроенные краны для душа.

Articolo	Note	CROMO	BO-NO-NKO		
7615		134,00	194,00		

7607WS

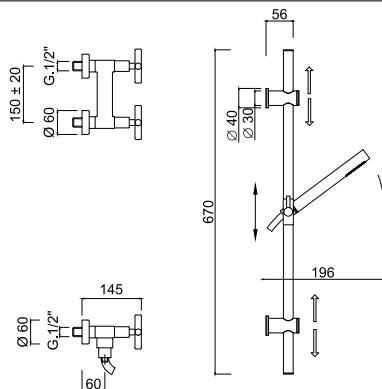

**Gruppo doccia esterno con saliscendi e doccia**  
External shower mixer with sliding rail set.  
Mélangeur extérieur de douche avec barre coulissante et ensemble de douche.  
Aufputz-Brausebatterie mit Brausestange und Brauseset.  
Grupo ducha externo con conjunto ducha.  
Смеситель для душа внешнего монтажа с комплектом штанги для душа.

Articolo	Note	CROMO	BO-NO-NKO		
7607WS		350,00	642,00		

7607WC-S

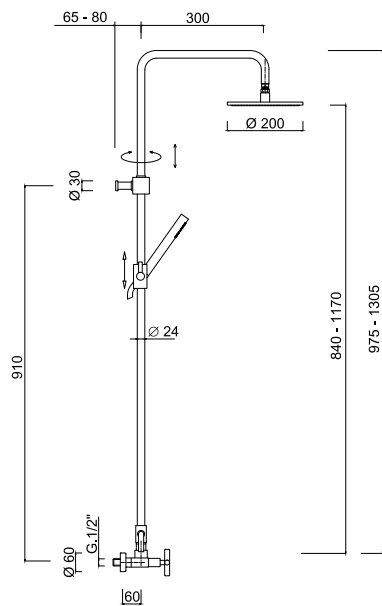

**Colonna doccia esterna, set doccia, soffione in ottone**  
External shower column, shower kit, brass shower head.  
Colonne de douche extérieure, ensemble de douche, pomme de douche en laiton.  
Aufputz-Standbrause, Brauseset, Kopfbrause in Messing.  
Columna ducha externa, conjunto de ducha, rociador en latón.  
Душевая колонна внешнего монтажа, душевой набор, верхний душ из латуни

Articolo	Note	CROMO	BO-NO-NKO		
7607WC-S		790,00	1.359,00		

7607

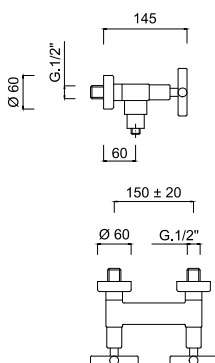

**Gruppo doccia esterno**  
External shower mixer.  
Mélangeur extérieur de douche.  
Aufputz-Brausebatterie.  
Grupo ducha externo.  
Смеситель для душа внешнего монтажа.

Articolo	Note	CROMO	BO-NO-NKO		
7607		195,00	282,00		



7601



**Gruppo vasca esterno con set doccia duplex**

External bathtub set with duplex shower kit.  
Mélangeur bain-douche extérieur avec ensemble de douche duplex.  
Wannenbatterie mit Schlauch-Handbrause und verstellbarem Wandhalter.  
Grupo bañera externo con conjunto de ducha duplex.  
Комплект для ванны внешнего монтажа с душевым набором "Duplex".

Articolo	Note	CROMO	BO-NO-NKO		
7601		358,00	572,00		

7601CT

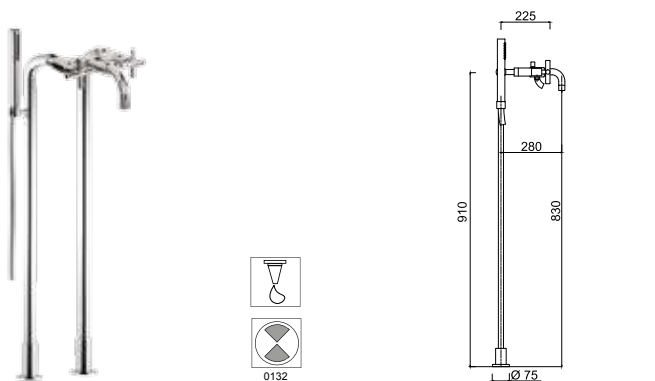

**Gruppo vasca esterno, colonne a pavimento, set doccia duplex.**

Wall-mounted bath set, deck mounted tap legs, duplex shower kit.  
Mélangeur bain-douche sur colonnes au sol, ensemble de douche.  
AP-Wannenarmatur, Standfüsse, Brauseset.  
Bimando bañera, tomas de agua a suelo, kit de ducha duplex.  
Комплект для ванны настенного монтажа, держатели для смесителя на край ванны, душевой набор "duplex"

Articolo	Note	CROMO	BO-NO-NKO		
7601CT		999,00	•		

7600WC-S

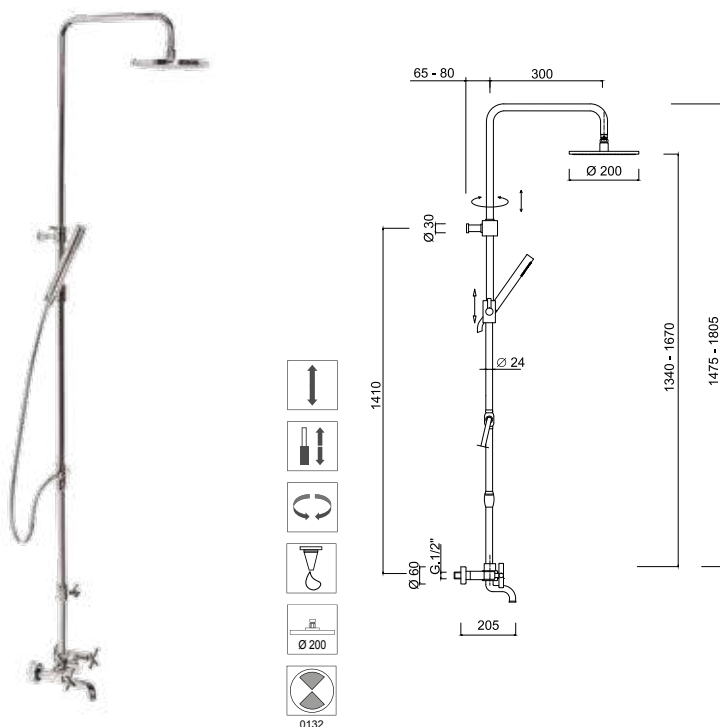

**Gruppo vasca esterno con colonna doccia, soffione ottone.**

Wall-mounted bath set with shower column and brass showerhead.  
Mélangeur bain-douche avec colonne de douche et pomme de douche en laiton.  
AP-Wannenbatterie mit Duschsäule, Kopfbrause aus Messing.  
Conjunto bañera de superficie, rociador en latón.  
Комплект для ванны настенного монтажа с душевой колонной и верхним душем из латуни

Articolo	Note	CROMO	BO-NO-NKO		
7600WC-S		1.130,00	•		

7603

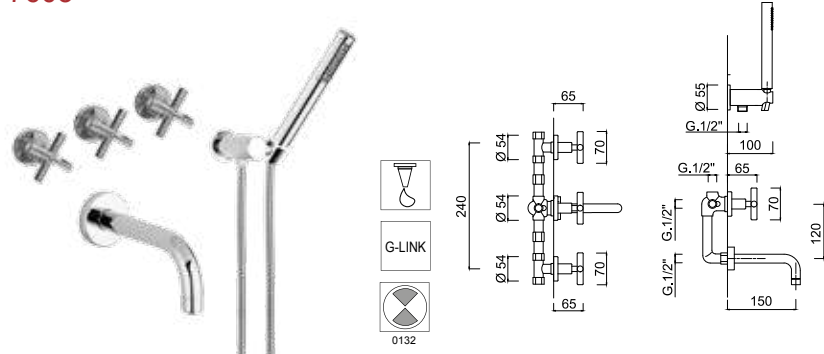

**Gruppo vasca incasso, kit duplex incasso, bocca mm.150.**

Built-in bath set, built-in duplex shower kit, spout mm 150.  
Mélangeur bain-douche à encastrer, ensemble de douche à encastrer, bec mm 150.  
UP-Wannenarmatur, UP-Brauseset, Auslauf mm 150.  
Bimando bañera empotrado, kit de ducha empotrado, caño mm 150.  
Комплект для ванны, встраиваемый душевой набор "duplex", излив 150 мм.

Articolo	Note	CROMO	BO-NO-NKO		
7603		445,00	667,00		

7660

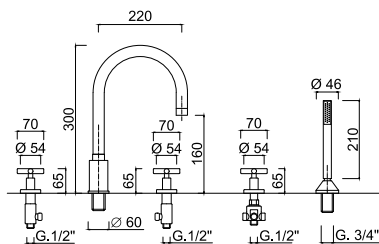

**Batteria bordo vasca 5 fori**

5-hole bath border set.  
Mélangeur bain/douche sur gorge 5 trous.  
5-Loch Wannen Kombination.  
Bimando bañera de repisa 5 agujeros.  
Комплект на борт ванны на 5 отверстий.

Articolo	Note	CROMO	BO-NO-NKO		
7660		540,00	783,00		

7665

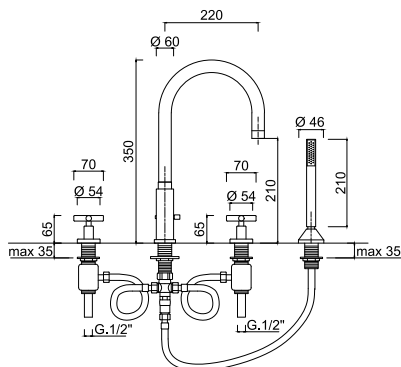

**Batteria bordo vasca 4 fori, bocca con deviatore.**

4-hole deck mounted set, spout with diverter.  
Mélangeur bain-douche sur gorge 4 trous, bec avec inverseur.  
4-Loch Wannenrandarmatur, Auslauf mit Umsteller.  
Grifo bañera de repisa 4 agujeros, caño con inversor.  
Комплект на 4 отверстия на край ванны, излив с дивертером

Articolo	Note	CROMO	BO-NO-NKO		
7665		485,00	704,00		

7616

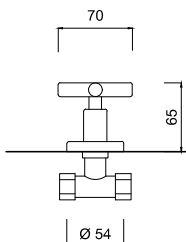

**Rubinetto incasso 1/2".**

1/2" built-in tap.  
Robinet d'arrêt à encastrer 3/4".  
UP-Absperrventil 3/4".  
Llave de paso a empotrar 3/4".  
Встраиваемый кран 1/2"

Articolo	Note	CROMO	BO-NO-NKO		
7616		59,00	85,00		

**NOTE**

**Potete trovare altre soluzioni per la Doccia nell'area WELLNESS. p.374**  
For additional Shower options please go to WELLNESS section.  
Pour plus de solutions pour la Douche visitez la section WELLNESS.  
Für weitere Duschalternativen sehen Sie bitte in dem Kapitel WELLNESS nach.  
Para más soluciones para Ducha visite la sección WELLNESS.  
Другие решения для Душа вы найдете в разделе Wellness.

**Per gli Accessori Bagno abbinati alla serie potete consultare la serie MODERNA. p.446**  
For matching Bathroom Fittings please check MODERNA line.  
Pour les Accessoires Salle de Bains coordonnés à la collection visitez la ligne MODERNA.  
Die zu der Serie passenden Bad-Accessoires finden Sie in dem Linie MODERNA.  
Para los Accesorios de Baño compatibles con la serie visite la línea MODERNA.  
Чтобы подобрать подходящие аксессуары для ванной комнаты, перейдите в Линия MODERNA.



G4





**7712A**

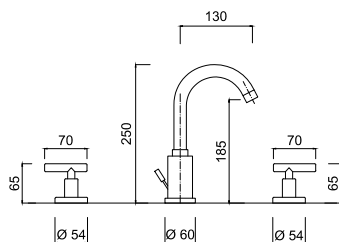

**Batteria lavabo 3 fori, bocca girevole, scarico 1"1/4**  
3-hole wash-basin set, swivel spout, 1"1/4 pop-up waste.  
Mélangeur lavabo à trois trous, bec mobile, vidage automatique 1"1/4.  
Waschtisch-Dreilochbatterie, Schwenkbarer Rohrauslauf, Ablaufgarnitur 1"1/4.  
Bateria lavabo con 3 agujeros, caño giratorio, tapón accionado por varilla 1"1/4.  
Комплект для раковины на 3 отверстия, поворотный излив, донный клапан 1"1/4.

Articolo	Note	CROMO	BO-NO-NKO		
7712A		277,00	374,00		

**7757A**

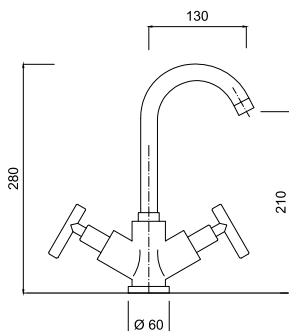

**Monoforo lavabo, bocca girevole, scarico 1"1/4 (con flessibile).**  
Wash-basin unit, swivel spout, 1"1/4 pop-up waste (with flexible).  
Mélangeur monotrou lavabo, bec mobile, vidage automatique 1"1/4 (avec flex.)  
Waschtisch-Einlochbatterie, Schwenkbarer Rohrauslauf, Ablaufgarnitur 1"1/4 (mit flexiblen Anschlussschläuchen).  
Monobloque lavabo, caño giratorio, tapón accionado por varilla 1"1/4 (con flexible).  
Смеситель для раковины, поворотный излив, донный клапан 1"1/4 (гибкая подводка).

Articolo	Note	CROMO	BO-NO-NKO		
7757A		230,00	310,00		

**7720-25**

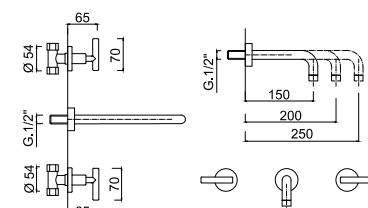

**Lavabo 3 fori a muro, bocca mm.250, senza scarico.**  
Wall-mounted 3-hole wash-basin set, spout mm 250, without pop-up waste.  
Mélangeur lavabo mural 3 trous, bec mm 250, sans vidage.  
3-Loch Waschtischarmatur für die Wandmontage, Auslauf mm 250, ohne Ablaufgarnitur.  
Bimando lavabo mural 3 agujeros, caño mm 250, sin desagüe automatico.  
Комплект для раковины на 3 отверстия настенного монтажа, излив 250 мм., без донного клапана

Articolo	Note	CROMO	BO-NO-BKO		
7720-25	mm 250	199,00	269,00		
7720-20	mm 200	199,00	269,00		
7720-15	mm 150	199,00	269,00		

**7723-25**

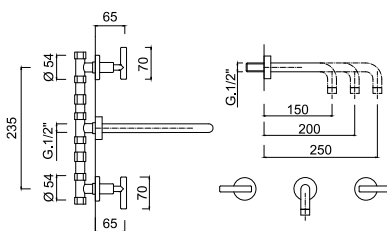

**Lavabo 3 fori a muro, mm250 (con connessioni).**  
3-hole wall mounted basin set, mm.250 (with connections).  
Mélangeur lavabo mural à 3 trous, mm.250 (avec les contacteurs).  
Waschtisch-Dreilochbatterie Wandmontage, mm.250 (mit Verbindungen).  
Lavabo de pared con 3 agujeros, mm.250 (con conexiones).  
Комплект настенного монтажа для раковины на 3 отверстия, mm.250 (с соединениями).

Articolo	Note	CROMO	BO-NO-BKO		
7723-25	mm 250	240,00	324,00		
7723-20	mm 200	240,00	324,00		
7723-15	mm 150	240,00	324,00		

**7713A**



**Batteria bidet 3 fori, scarico 1"1/4.**  
3-hole bidet set, 1"1/4 pop-up waste.  
Mélangeur bidet 3 trous, vidage 1"1/4 (avec flexibles).  
3-Loch Bidetarmatur, Ablaufgarnitur 1"1/4.  
Grifo de bidé 3 agujeros, desagüe automatico 1"1/4.  
Комплект для биде на 3 отверстия, донный клапан 1"1/4

Articolo	Note	CROMO	BO-NO-NKO		
7713A		170,00	246,00		

**7745A**

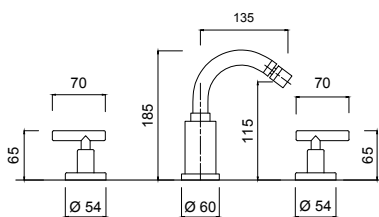

**Batteria bidet 3 fori, bocca girevole, scarico 1"1/4**  
3-hole bidet set, swivel spout, 1"1/4 pop-up waste.  
Mélangeur bidet à 3 trous, bec mobile, vidage automatique 1"1/4.  
Bidet-Dreilochbatterie, Schwenkbarer Rohrauslauf, Ablaufgarnitur 1"1/4.  
Bateria bidet, caño giratorio, tapón accionado por varilla 1"1/4.  
Комплект для биде на 3 отверстия, поворотный излив, донный клапан 1"1/4 (гибкая подводка).

Articolo	Note	CROMO	BO-NO-NKO
<b>7745A</b>		274,00	397,00

**7759A**

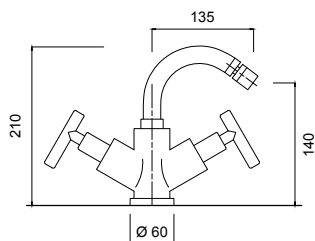

**Monoforo bidet, bocca girevole, scarico 1"1/4 (con flessibile)**  
Bidet unit, swivel spout, 1"1/4 pop-up waste (with flexible).  
Mélangeur monotrou bidet, bec mobile, vidage automatique 1"1/4 (avec flex.)  
Bidet-Einlochbatterie, Schwenkbarer Rohrauslauf, Ablaufgarnitur 1"1/4 (mit flexiblen Anschlussschläuchen).  
Monobloque bidet, caño giratorio, tapón accionado por varilla 1"1/4 (con flexible).  
Смеситель для биде, поворотный излив, донный клапан 1"1/4 (гибкая подводка).

Articolo	Note	CROMO	BO-NO-NKO
<b>7759A</b>		230,00	310,00

**7715W2KS**

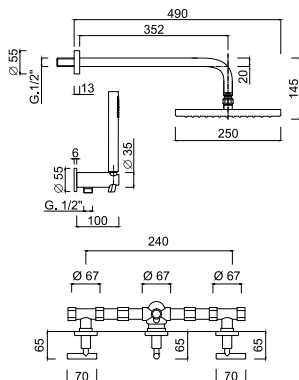

**Set doccia incasso con deviatore 2 vie, soffione ottone mm.250, kit duplex incasso.**  
Built-in shower set with 2-way diverter, brass showerhead mm 250, duplex shower kit.  
Mélangeur douche à encastrer avec inverseur à 2 sorties, pomme de douche en laiton mm 250, ensemble de douche.  
UP-Brausearmatur mit 2-Wege-Umstellung, Kopfbrause aus Messing mm 250, UP-Brauseset.  
Bimando ducha empotrado con inversor 2 vías, rociador en latón mm 250, kit de ducha empotrado.  
Встраиваемый комплект для душа с дивертером на 2 выхода, верхний душ из латуни 250 мм, душевой набор "duplex"

Articolo	Note	CROMO	BO-NO-NKO
<b>7715W2KS</b>		736,00	1.172,00

**7715WB-25**

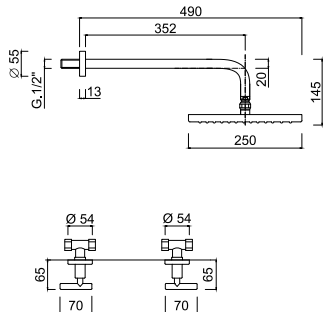

**Set doccia incasso, soffione in ottone mm.250.**  
Built-in shower set, brass showerhead mm 250.  
Mitigeur douche à encastrer, pomme de douche en laiton mm 250.  
UP-Brausemischer mit Kopfbrause aus Messing mm 250.  
Bimando ducha empotrado, rociador en latón mm 250.  
Встраиваемый комплект для душа, верхний душ из латуни 250 мм

Articolo	Note	CROMO	BO-NO-NKO
<b>7715WB-25</b>		495,00	720,00

**7715W2**

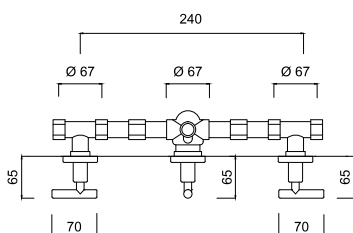

**Rubineti incasso doccia e deviatore 2 uscite.**  
Concealed shower taps and 2 outlets diverter.  
Mélangeur douche encastré et inverseur 2 sorties.  
Unterputz-Brausebatterie mit 2-Ausgänge Umstellung.  
Bimando ducha empotrado y desviador 2 salidas.  
Встроенные краны для душа и дивертер на 2 выхода

Articolo	Note	CROMO	BO-NO-NKO
<b>7715W2</b>		302,00	437,00

7715

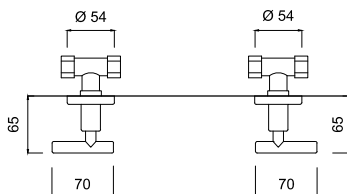

**Rubinetti incasso doccia**  
Concealed shower taps.  
Mélangeur douche encastré.  
Unterputz-Brausebatterie.  
Grupo ducha empotrar.  
Встроенные краны для душа.

Articolo	Note	CROMO	BO-NO-NKO		
7715		134,00	194,00		

7707WS

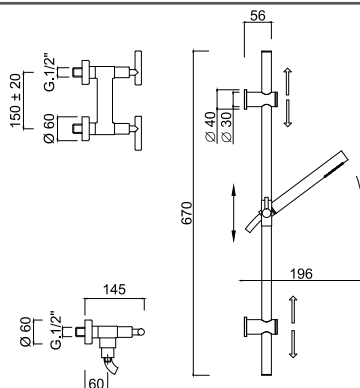

**Gruppo doccia esterno con saliscendi e doccia**  
External shower mixer with sliding rail set.  
Mélangeur extérieur de douche avec barre coulissante et ensemble de douche.  
Aufputz-Brausebatterie mit Brausestange und Brauseset.  
Grupo ducha externo con conjunto ducha.  
Смеситель для душа внешнего монтажа с комплектом штанги для душа.

Articolo	Note	CROMO	BO-NO-NKO		
7707WS		350,00	642,00		

7707WC-S

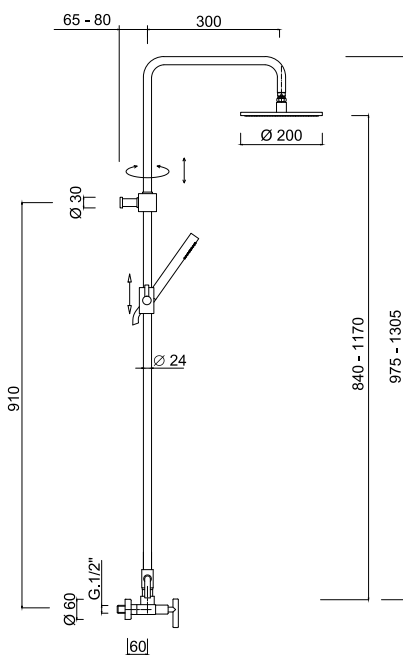

**Colonna doccia esterna, set doccia, soffione in ottone**  
External shower column, shower kit, brass shower head.  
Colonne de douche extérieure, ensemble de douche, pomme de douche en laiton.  
Aufputz-Standbrause, Brauseset, Kopfbrause in Messing.  
Columna ducha externa, conjunto de ducha, rociador en latón.  
Душевая колонна внешнего монтажа, душевой набор, верхний душ из латуни.

Articolo	Note	CROMO	BO-NO-NKO		
7707WC-S		790,00	1.359,00		

7707

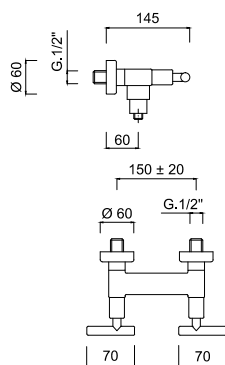

**Gruppo doccia esterno**  
External shower mixer.  
Mélangeur extérieur de douche.  
Aufputz-Brausebatterie.  
Grupo ducha externo.  
Смеситель для душа внешнего монтажа.

Articolo	Note	CROMO	BO-NO-NKO		
7707		195,00	282,00		

7701

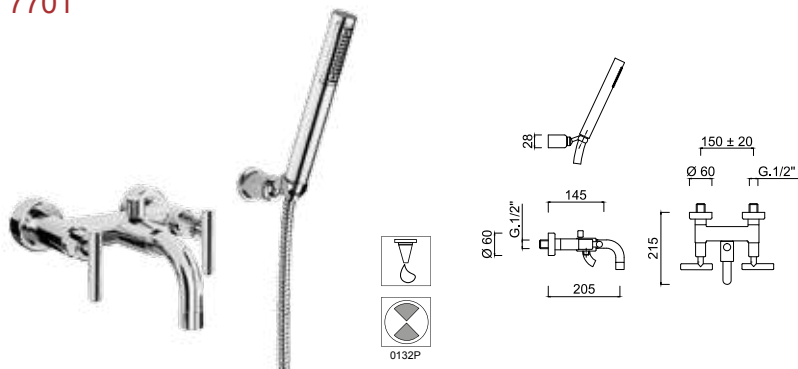

**Gruppo vasca esterno con set doccia duplex**

External bathtub set with duplex shower kit.  
Mélangeur bain-douche extérieur avec ensemble de douche duplex.  
Wannenbatterie mit Schlauch-Handbrause und verstellbarem Wandhalter.  
Grupo bañera externo con conjunto de ducha duplex.  
Комплект для ванны внешнего монтажа с душевым набором "Duplex".

Articolo	Note	CROMO	BO-NO-NKO
7701		358,00	572,00

7701CT

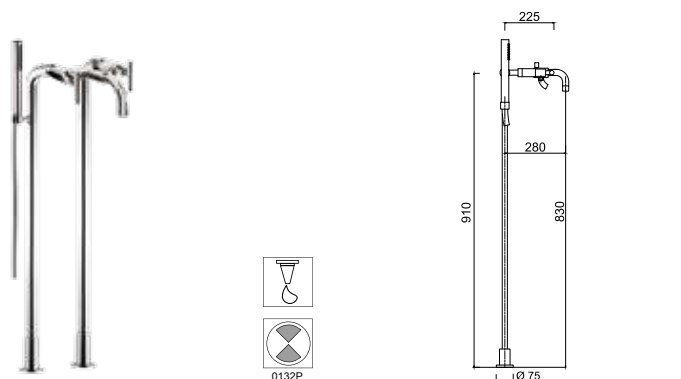

**Gruppo vasca esterno, colonne a pavimento, set doccia duplex.**

Wall-mounted bath set, deck mounted tap legs, duplex shower kit.  
Mélangeur bain-douche sur colonnes au sol, ensemble de douche.  
AP-Wannenarmatur, Standfüsse, Brauseset.  
Bimando bañera, tomas de agua a suelo, kit de ducha duplex.  
Комплект для ванны настенного монтажа, держатели для смесителя на край ванны, душевой набор "duplex"

Articolo	Note	CROMO	BO-NO-NKO
7701CT		999,00	•

7700WC-S

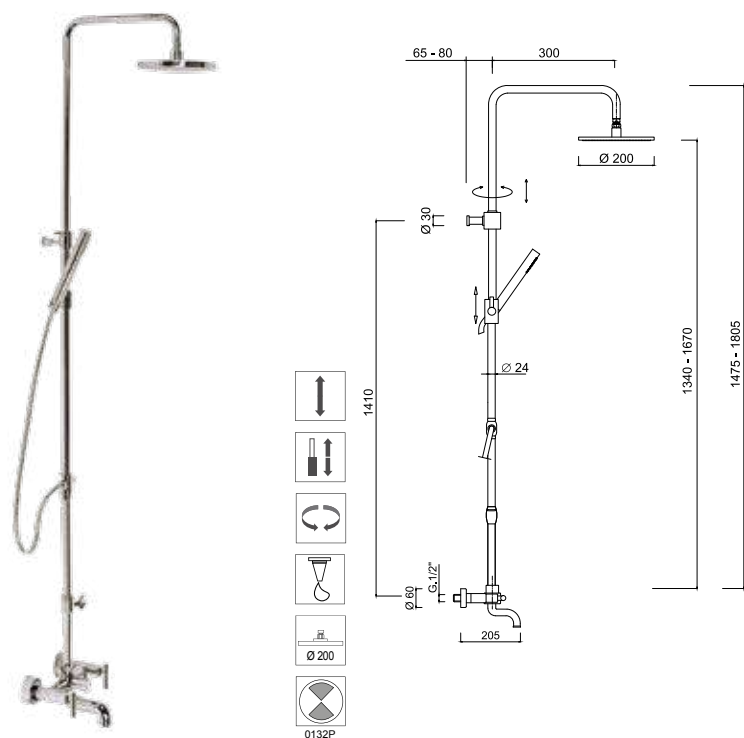

**Gruppo vasca esterno con colonna doccia, soffione ottone.**

Wall-mounted bath set with shower column and brass showerhead.  
Mélangeur bain-douche avec colonne de douche et pomme de douche en laiton.  
AP-Wannenbatterie mit Duschsäule, Kopfbrause aus Messing.  
Conjunto bañera de superficie, rociador en latón.  
Комплект для ванны настенного монтажа с душевой колонной и верхним душем из латуни

Articolo	Note	CROMO	BO-NO-NKO
7700WC-S		1.130,00	•

7703

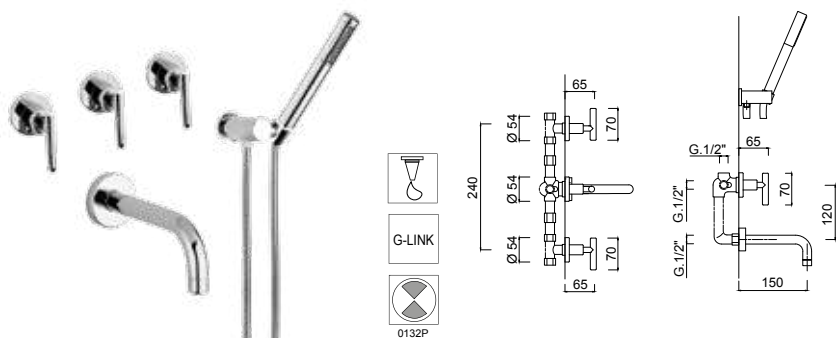

**Gruppo vasca incasso, kit duplex incasso, bocca mm.150.**

Built-in bath set, built-in duplex shower kit, spout mm 150.  
Mélangeur bain-douche à encastrer, ensemble de douche à encastrer, bec mm 150.  
UP-Wannenarmatur, UP-Brauseset, Auslauf mm 150.  
Bimando bañera empotrado, kit de ducha empotrado, caño mm 150.  
Комплект для ванны, встраиваемый душевой набор "duplex", излив 150 мм.

Articolo	Note	CROMO	BO-NO-NKO
7703		445,00	667,00

7760

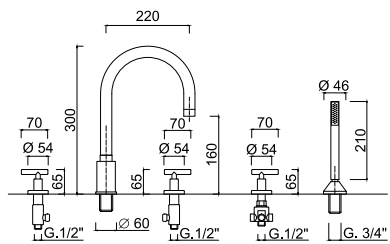

**Batteria bordo vasca 5 fori**  
5-hole bath border set.  
Mélangeur bain/douche sur gorge 5 trous.  
5-Loch Wannen Kombination.  
Bimando bañera de repisa 5 agujeros.  
Комплект на борт ванны на 5 отверстий.

Articolo	Note	CROMO	BO-NO-NKO		
7760		524,00	759,00		

7765

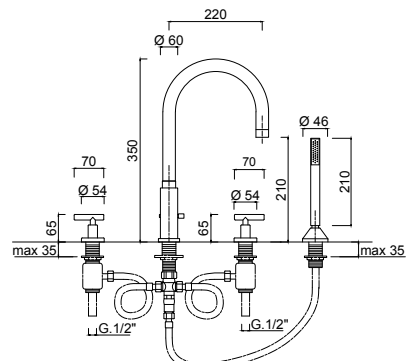

**Batteria bordo vasca 4 fori, bocca con deviatore.**  
4-hole deck mounted set, spout with diverter.  
Mélangeur bain-douche sur gorge 4 trous, bec avec inverseur.  
4-Loch Wannenrandarmatur, Auslauf mit Umsteller.  
Grifo bañera de repisa 4 agujeros, caño con inversor.  
Комплект на 4 отверстия на край ванны, излив с дивертером

Articolo	Note	CROMO	BO-NO-NKO		
7765		470,00	681,00		

7716

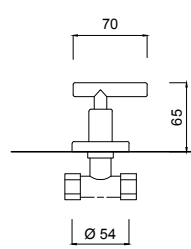

**Rubinetto incasso 1/2".**  
1/2" built-in tap.  
Robinet d'arrêt à encastrer 3/4".  
UP-Absperrventil 3/4".  
Llave de paso a empotrar 3/4".  
Встраиваемый кран 1/2"

Articolo	Note	CROMO	BO-NO-NKO		
7716		59,00	85,00		

**NOTE**

**Potete trovare altre soluzioni per la Doccia nell'area WELLNESS.** p.374  
For additional Shower options please go to WELLNESS section.  
Pour plus de solutions pour la Douche visitez la section WELLNESS.  
Für weitere Duschalternativen sehen Sie bitte in dem Kapitel WELLNESS nach.  
Para más soluciones para Ducha visite la sección WELLNESS.  
Другие решения для Душа вы найдете в разделе Wellness.

**Per gli Accessori Bagno abbinati alla serie potete consultare la serie MODERNA.** p.446  
For matching Bathroom Fittings please check MODERNA line.  
Pour les Accessoires Salle de Bains coordonnés à la collection visitez la ligne MODERNA.  
Die zu der Serie passenden Bad-Accessoires finden Sie in dem Linie MODERNA.  
Para los Accesorios de Baño compatibles con la serie visite la línea MODERNA.  
Чтобы подобрать подходящие аксессуары для ванной комнаты, перейдите в Линия MODERNA.





PLP





**PLP030B1**

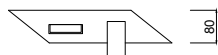
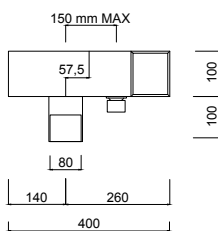
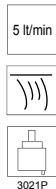

**Lavabo a parete PLP con bocca a CASCATA.**  
 PLP wall mounted basin mixer, cascade spout.  
 Mitigeur lavabo mural PLP avec bec à cascade  
 PLP Waschtisch-Einhebelmischer Wandmontage mit Wasserfall-Auslauf.  
 Lavabo de pared PLP con caño en cascada.  
 PLP Встроенный в стену смеситель с каскадным изливом.

Articolo	Note	CROMO			
PLP030B1		870,00			

**PLP030B2**

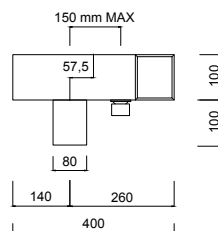

**Lavabo a parete PLP con bocca con aeratore orientabile.**  
 PLP wall mounted basin mixer, spout with adjustable aerator.  
 Mitigeur lavabo mural PLP, mousseur orientable.  
 PLP Waschtisch-Einhebelmischer Wandmontage, Auslauf mit regulierbarer Verdampfer.  
 Lavabo de pared PLP, caño con vaporizador orientable.  
 PLP Встроенный в стену смеситель с изливом с азратором.

Articolo	Note	CROMO			
PLP030B2		773,00			

**PLP030B3**

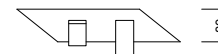
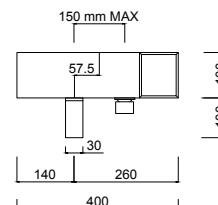

**Lavabo a parete PLP con bocca piatta.**  
 PLP wall mounted basin mixer with flat spout.  
 Mitigeur lavabo mural PLP bec plat.  
 PLP Waschtisch-Einhebelmischer Wandmontage, Flach-Auslauf.  
 Lavabo de pared PLP, caño plano.  
 PLP Встроенный в стену смеситель с плоским изливом.

Articolo	Note	CROMO			
PLP030B3		713,00			

**PLP010B1**

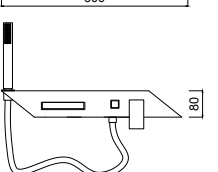
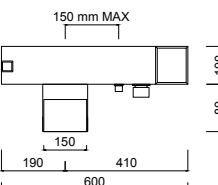

**Vasca esterno PLP con bocca a CASCATA.**  
 PLP External bath mixer, cascade spout.  
 Mitigeur bain/douche mural PLP avec bec à cascade.  
 PLP Aufputz-Einhebelmischer mit Wasserfall-Auslauf.  
 Monomando bañera PLP externo con caño en cascada.  
 PLP Внешний смеситель для ванны с каскадным изливом.

Articolo	Note	CROMO			
PLP010B1		1.481,00			

**PLP010B2**

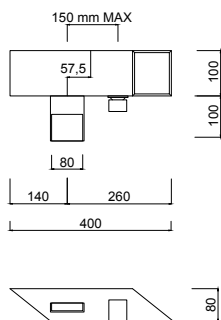
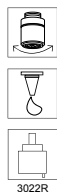

**Vasca esterno PLP con bocca con aeratore orientabile.**  
 PLP External bath mixer, spout with adjustable aerator.  
 Mitigeur bain/douche mural PLP, mousseur orientable.  
 PLP Aufputz-Einhebelmischer, Auslauf mit regulierbarer Verdampfer.  
 Monomando bañera PLP externo, caño con vaporizador orientable.  
 PLP Внешний смеситель для ванны с аэратором.

Articolo	Note	CROMO			
PLP010B2		1.307,00			

**PLP010B3**

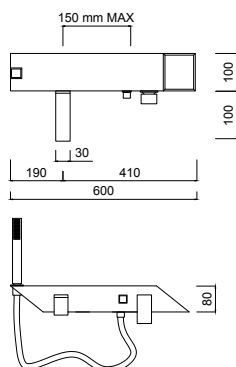

**Vasca esterno PLP con bocca piatta.**  
 PLP External bath mixer with flat spout.  
 Mitigeur bain/douche mural PLP bec plat.  
 PLP Aufputz-Einhebelmischer, Flach-Auslauf.  
 Monomando bañera PLP externo, caño plano.  
 PLP Внешний смеситель для ванны с плоским изливом.

Articolo	Note	CROMO			
PLP010B3		1.230,00			



**ALLUMINIO**  
ALUMINIUM - ALUMINIUM - ALUMINIO  
АЛЮМИНИЙ



**NERO**  
BLACK - NOIR - SCHWARZ  
NEGRO - ЧЕРНЫЙ



**BIANCO**  
WHITE - BLANC - WEISS  
BLANCO - БЕЛЫЙ

**NOTE**

**Potete trovare altre soluzioni per la Doccia nell'area WELLNESS.** p.374  
 For additional Shower options please go to WELLNESS section.  
 Pour plus de solutions pour la Douche visitez la section WELLNESS.  
 Für weitere Duschalternativen sehen Sie bitte in dem Kapitel WELLNESS nach.  
 Para más soluciones para Ducha visite la sección WELLNESS.  
 Другие решения для Душа вы найдете в разделе Wellness.

**Per gli Accessori Bagno abbinati alla serie potete consultare la serie ERICA.** p.440  
 For matching Bathroom Fittings please check ERICA line.  
 Pour les Accessoires Salle de Bains coordonnés à la collection visitez la ligne ERICA.  
 Die zu der Serie passenden Bad-Accessoires finden Sie in dem Linie ERICA.  
 Para los Accesorios de Baño compatibles con la serie visite la línea ERICA.  
 Чтобы подобрать подходящие аксессуары для ванной комнаты, перейдите в Линия ERICA.

Quack



**9105A**

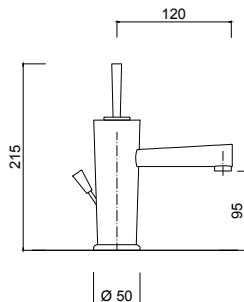

**Monocomando lavabo, scarico 1"1/4 (con flessibile).**  
Wash-basin single-lever mixer, 1"1/4 pop-up waste (with flexible).  
Mitigeur lavabo avec vidage 1"1/4 (avec flexible).  
Einhand-Waschtischbatterie mit Ablaufgarnitur 1"1/4 (mit flexiblen Anschlussschläuchen).  
Monomando lavabo tapón accionado por varilla 1"1/4 (con flexible).  
Однорычажный смеситель для раковины, донный клапан 1"1/4 (гибкая подводка).

Articolo	Note	CROMO			
9105A		262,00			

**9111A**

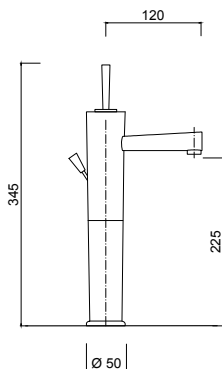

**Monocomando lavabo con prolunga, scarico 1"1/4 (con flessibile).**  
High wash-basin single-lever mixer, 1"1/4 pop-up waste (with flexible).  
Mitigeur lavabo avec bec haut et vidage 1"1/4 (avec flexible).  
Einhand-Waschtischbatterie mit hohem Auslauf und Ablaufgarnitur 1"1/4 (mit flexiblen Anschlussschläuchen).  
Monomando lavabo alto tapón accionado por varilla 1"1/4 (con flexible).  
Высокий однорычажный смеситель для раковины, донный клапан 1"1/4 (гибкая подводка).

Articolo	Note	CROMO			
9111A		307,00			

**9111BLA**

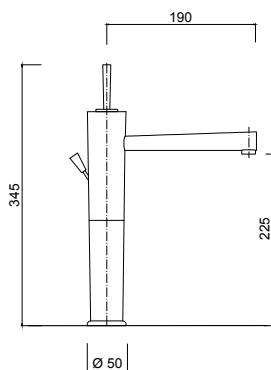

**Monocomando lavabo con prolunga, bocca lunga, scarico 1"1/4 (con flessibile)**  
High wash-basin single-lever mixer with long spout, 1"1/4 pop-up waste (with flex.).  
Mitigeur lavabo haut avec bec long, avec vidage 1"1/4 (avec flexible).  
Einhand-Waschtischbatterie mit hohem und langem Auslauf, mit Ablaufgarnitur 1"1/4 (mit flexiblen Anschlussschläuchen).  
Monomando lavabo alto con caño longo, tapón accionado por varilla 1"1/4 (con flex.).  
Высокий однорычажный смеситель для раковины с удлиненным изливом, донный клапан 1"1/4 (гибкая подводка).

Articolo	Note	CROMO			
9111BLA		377,00			

**9120-25**

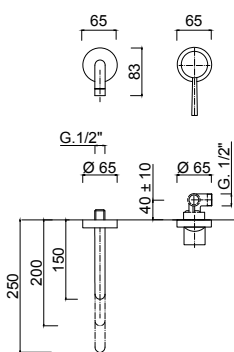

**Monocomando lavabo a muro, senza scarico, mm.250**  
Wall-mounted wash-basin set, without pop-up waste.  
Mitigeur lavabo mural, sans vidage.  
Waschtisch- Einhebelmischer Wandmontage, ohne Ablaufgarnitur.  
Lavabo de pared, sin desagüe.  
Комплект настенного монтажа для раковины, без донного клапана.

Articolo	Note	CROMO			
9120-25	mm 250	147,00			
9120-20	mm 200	147,00			
9120-15	mm 150	147,00			

**9107A**

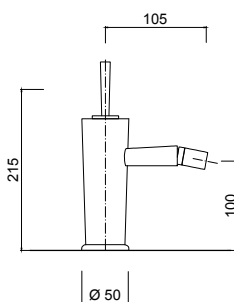

**Monocomando bidet, scarico 1"1/4 (con flessibile).**  
Bidet single-lever mixer, 1"1/4 pop-up waste (with flexible).  
Mitigeur bidet avec vidage 1"1/4 (avec flexible).  
Einhand-Bidetbatterie mit Ablaufgarnitur 1"1/4 (mit flexiblen Anschlussschläuchen).  
Monomando bidet, tapón accionado por varilla 1"1/4 (con flexible).  
Однорычажный смеситель для биде, донный клапан 1"1/4 (гибкая подводка).

Articolo	Note	CROMO			
9107A		262,00			

9115

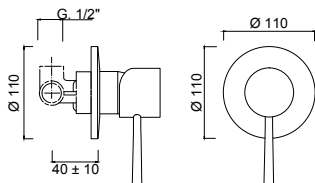

**Monocomando doccia incasso.**  
Shower built-in single-lever mixer.  
Mitigeur pour douche à encaissement.  
Unterputz-Duscheneinhebelmischer.  
Monomando ducha para empotrar.  
Однорычажный встроенный смеситель для душа.

Articolo	Note	CROMO			
9115		88,00			

9113

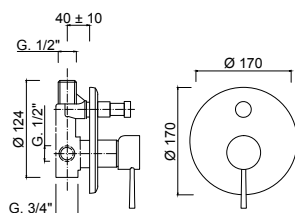
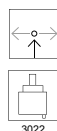

**Monocomando doccia incasso con deviatore.**  
Shower built-in single-lever mixer with diverter.  
Mitigeur pour douche à encaissement avec inverseur.  
Unterputz-Duscheneinhebelmischer mit Umstellung.  
Monomando ducha para empotrar con desviador.  
Однорычажный встроенный смеситель для душа с дивертером.

Articolo	Note	CROMO			
9113		184,00			

9108

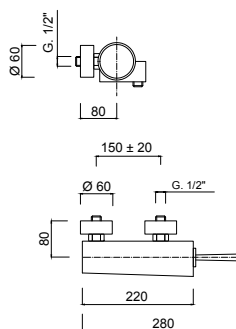

**Monocomando doccia esterno**  
External single-lever shower mixer.  
Mitigeur pour douche externe.  
Aufputz-Einhebelbatterie.  
Monomando ducha externo.  
Однорычажный смеситель внешнего монтажа для душа.

Articolo	Note	CROMO			
9108		290,00			

9101

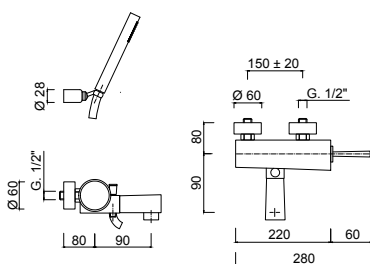

**Monocomando vasca esterno con set doccia duplex.**  
External bathtub single-lever mixer with duplex shower kit.  
Mitigeur bain/douche extérieur avec ensemble de douche duplex.  
Aufputz-Einhebelmischer für die Badewanne mit Brauseset Duplex.  
Monomando bañera externo con conjunto de ducha duplex.  
Однорычажный смеситель внешнего монтажа для ванны с душевым набором "Duplex"

Articolo	Note	CROMO			
9101		426,00			

**NOTE**

**Potete trovare altre soluzioni per la Doccia nell'area WELLNESS. p.374**  
For additional Shower options please go to WELLNESS section.  
Pour plus de solutions pour la Douche visitez la section WELLNESS.  
Für weitere Duschalternativen sehen Sie bitte in dem Kapitel WELLNESS nach.  
Para más soluciones para Ducha visite la sección WELLNESS.  
Другие решения для Душа вы найдете в разделе Wellness.

**Per gli Accessori Bagno abbinati alla serie potete consultare la serie MODERNA. p.446**  
For matching Bathroom Fittings please check MODERNA line.  
Pour les Accessoires Salle de Bains coordonnés à la collection visitez la ligne MODERNA.  
Die zu der Serie passenden Bad-Accessoires finden Sie in dem Linie MODERNA.  
Para los Accesorios de Baño compatibles con la serie visite la línea MODERNA.  
Чтобы подобрать подходящие аксессуары для ванной комнаты, перейдите в Линия MODERNA.

# Elica

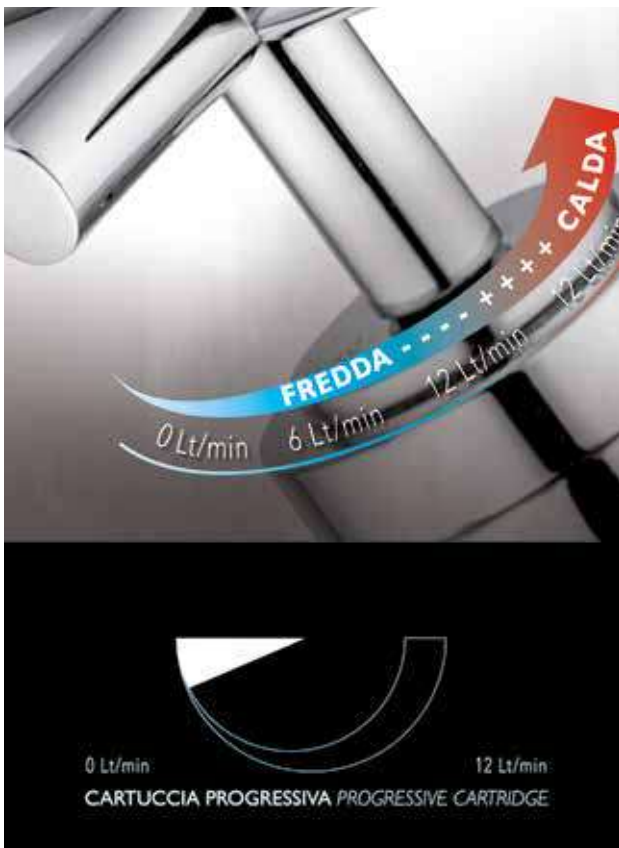





**9205A**

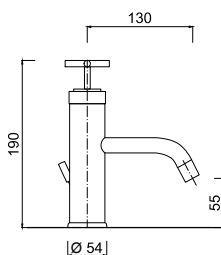

**Monocomando lavabo, scarico 1"1/4 (con flessibile).**  
Wash-basin single-lever mixer, 1"1/4 pop-up waste (with flexible).  
Mitigeur lavabo avec vidage 1"1/4 (avec flexible).  
Einhand-Waschtischbatterie mit Ablaufgarnitur 1"1/4 (mit flexiblen Anschlussschläuchen).  
Monomando lavabo tapón accionado por varilla 1"1/4 (con flexible).  
Однорычажный смеситель для раковины, донный клапан 1"1/4 (гибкая подводка).

Articolo	Note	CROMO			
9205A		198,00			

**9220-25**

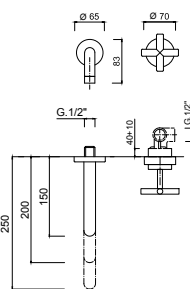

**Monocomando lavabo a muro, senza scarico, mm.250**  
Wall-mounted wash-basin set, without pop-up waste.  
Mitigeur lavabo mural, sans vidage.  
Waschtisch- Einhebelmischer Wandmontage, ohne Ablaufgarnitur.  
Lavabo de pared, sin desagüe.  
Комплект настенного монтажа для раковины, без донного клапана.

Articolo	Note	CROMO			
9220-25	mm 250	160,00			
9220-20	mm 200	160,00			
9220-15	mm 150	160,00			

**9239A**

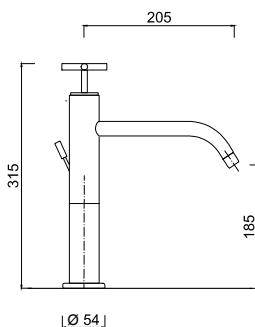

**Monocomando lavabo con prolunga, bocca lunga, scarico 1"1/4 (con flessibile)**  
High wash-basin single-lever mixer with long spout, 1"1/4 pop-up waste (with flex.).  
Mitigeur lavabo haut avec bec long, avec vidage 1"1/4 (avec flexible).  
Einhand-Waschtischbatterie mit hohem und langem Auslauf, mit Ablaufgarnitur 1"1/4 (mit flexiblen Anschlussschläuchen).  
Monomando lavabo alto con caño longo, tapón accionado por varilla 1"1/4 (con flex.).  
Высокий однорычажный смеситель для раковины с удлиненным изливом, донный клапан 1"1/4 (гибкая подводка).

Articolo	Note	CROMO			
9239A		252,00			

**9207A**

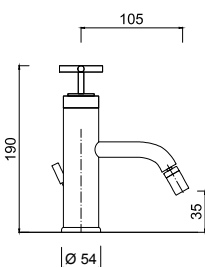

**Monocomando bidet, scarico 1"1/4 (con flessibile).**  
Bidet single-lever mixer, 1"1/4 pop-up waste (with flexible).  
Mitigeur bidet avec vidage 1"1/4 (avec flexible).  
Einhand-Bidetbatterie mit Ablaufgarnitur 1"1/4 (mit flexiblen Anschlussschläuchen).  
Monomando bidet, tapón accionado por varilla 1"1/4 (con flexible).  
Однорычажный смеситель для биде, донный клапан 1"1/4 (гибкая подводка).

Articolo	Note	CROMO			
9207A		198,00			

**9215**

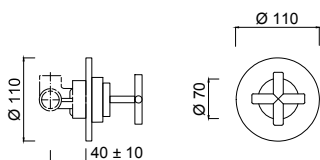

**Monocomando doccia incasso.**  
Shower built-in single-lever mixer.  
Mitigeur pour douche à encaissement.  
Unterputz-Duscheneinhebelmischer.  
Monomando ducha para empotrar.  
Однорычажный встроенный смеситель для душа.

Articolo	Note	CROMO			
9215		92,00			

9213

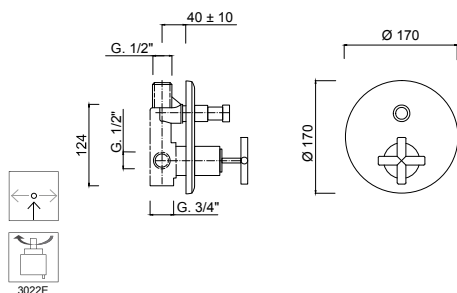

**Monocomando doccia incasso con deviatore.**  
Shower built-in single-lever mixer with diverter.  
Mitigeur pour douche à encaissement avec inverseur.  
Unterputz- Duscheneinhebelmischer mit Umstellung.  
Monomando ducha para empotrar con desviador.  
Однорычажный встроенный смеситель для душа с дивертером.

Articolo	Note	CROMO			
9213		189,00			

9208

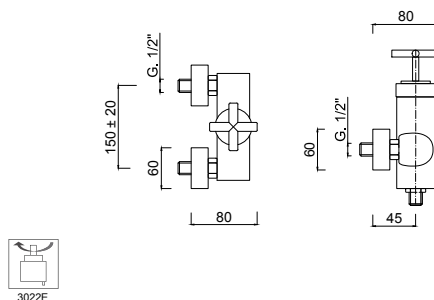

**Monocomando doccia esterno**  
External single-lever shower mixer.  
Mitigeur pour douche externe.  
Aufputz- Einhebelbatterie.  
Monomando ducha externo.  
Однорычажный смеситель внешнего монтажа для душа.

Articolo	Note	CROMO			
9208		225,00			

9201

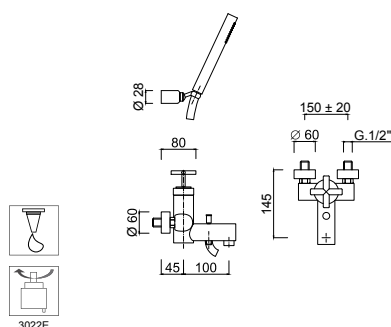

**Monocomando vasca esterno con set doccia duplex.**  
External bathtub single-lever mixer with duplex shower kit.  
Mitigeur bain/douche extérieur avec ensemble de douche duplex.  
Aufputz- Einhebelmischer für die Badewanne mit Brauseset Duplex.  
Monomando bañera externo con conjunto de ducha duplex.  
Однорычажный смеситель внешнего монтажа для ванны с душевым набором "Duplex"

Articolo	Note	CROMO			
9201		353,00			

**NOTE**

**Potete trovare altre soluzioni per la Doccia nell'area WELLNESS. p.374**  
For additional Shower options please go to WELLNESS section.  
Pour plus de solutions pour la Douche visitez la section WELLNESS.  
Für weitere Duschalternativen sehen Sie bitte in dem Kapitel WELLNESS nach.  
Para más soluciones para Ducha visite la sección WELLNESS.  
Другие решения для Душа вы найдете в разделе Wellness.

**Per gli Accessori Bagno abbinati alla serie potete consultare la serie MODERNA. p.446**  
For matching Bathroom Fittings please check MODERNA line.  
Pour les Accessoires Salle de Bains coordonnés à la collection visitez la ligne MODERNA.  
Die zu der Serie passenden Bad-Accessoires finden Sie in dem Linie MODERNA.  
Para los Accesorios de Baño compatibles con la serie visite la línea MODERNA.  
Чтобы подобрать подходящие аксессуары для ванной комнаты, перейдите в Линия MODERNA.



CLASSICO



Praga

Praga Crystal

Crystals from Swarovski®



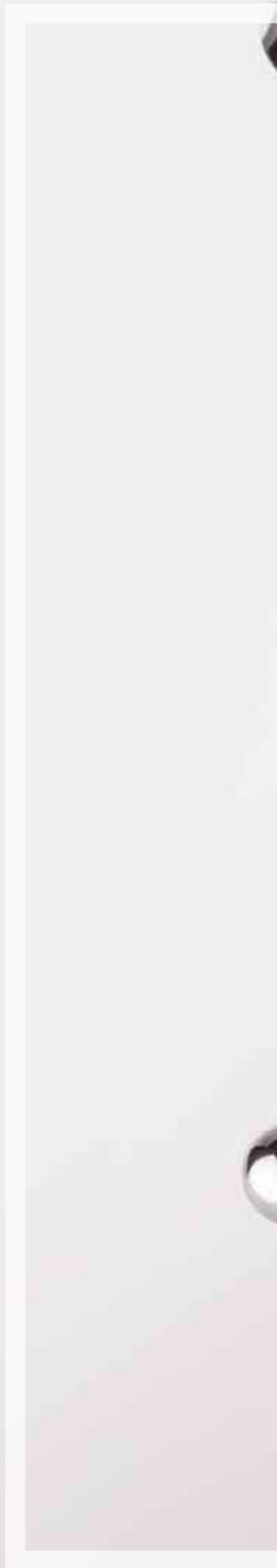









**7512A**

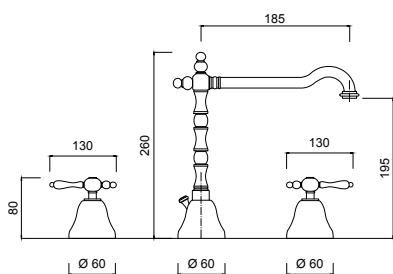

**Batteria lavabo 3 fori, bocca girevole, scarico 1"1/4**  
3-hole wash-basin set, swivel spout, 1"1/4 pop-up waste.  
Mélangeur lavabo à trois trous, bec mobile, vidage automatique 1"1/4.  
Waschtisch-Dreilochbatterie, Rohrauslauf, Ablaufgarnitur 1"1/4.  
Bateria lavabo con 3 agujeros, caño giratorio, tapón accionado por varilla 1"1/4.  
Комплект для раковины на 3 отверстия, поворотный излив, донный клапан 1"1/4

Articolo	Note	CROMO	CR	BR	O
7512A		294,00	323,00	412,00	529,00
7512AL	L	306,00	335,00	424,00	541,00
7512ACE	CE	314,00	343,00	432,00	549,00
7512A/S	S	394,00	423,00	512,00	629,00

**S7556A**

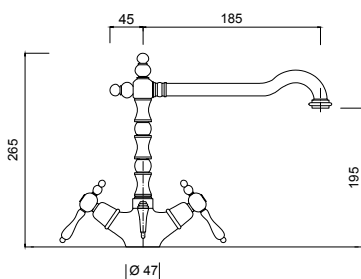

**Monoforo lavabo, bocca girevole, scarico 1"1/4 (con flessibile).**  
Wash-basin unit, swivel spout, 1"1/4 pop-up waste (with flexible).  
Mélangeur monotrou lavabo, bec mobile, vidage automatique 1"1/4 (avec flex.)  
Waschtisch-Einlochbatterie, Rohrauslauf, Ablaufgarnitur 1"1/4 (mit flexiblen Anschlusschläuchen).  
Monobloque lavabo, caño giratorio, tapón accionado por varilla 1"1/4 (con flexible).  
Смеситель для раковины, поворотный излив, донный клапан 1"1/4 (гибкая подводка).

Articolo	Note	CROMO	CR	BR	O
S7556A		240,00	264,00	336,00	432,00
S7556AL	L	252,00	276,00	348,00	444,00
S7556ACE	CE	260,00	284,00	356,00	452,00
S7556A/S	S	340,00	364,00	436,00	532,00

**SA7561**

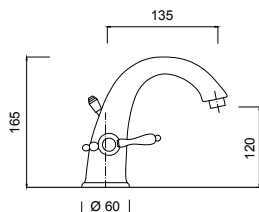

**Monoforo lavabo, scarico 1"1/4 (con flessibile).**  
Wash-basin set, 1"1/4 pop-up waste (with flexibles).  
Mélangeur lavabo monotrou, vidage 1"1/4 (avec flexibles).  
Waschtischarmatur, Ablaufgarnitur 1"1/4 (inkl. Anschlusschläuche).  
Bimando lavabo, desagüe automático 1"1/4 (con flex.).  
Комплект для раковины, донный клапан 1"1/4 (с гибкими шлангами)

Articolo	Note	CROMO	CR	BR	O
SA7561		220,00	242,00	308,00	396,00
SA7561L	L	232,00	254,00	320,00	408,00
SA7561CE	CE	240,00	262,00	328,00	416,00
SA7561/S	S	320,00	342,00	408,00	496,00

**7533**

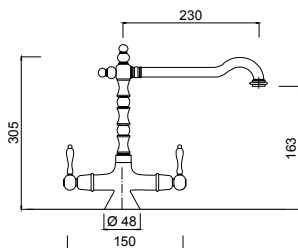

**Monoforo lavabo, bocca girevole, senza scarico (con flessibile).**  
Wash-basin set, swivel spout, without pop-up waste (with flexibles).  
Mélangeur lavabo monotrou, bec orientable, sans vidage (avec flexibles).  
Waschtischarmatur mit Schwenkauslauf, ohne Ablaufgarnitur (inkl. Anschlusschläuche).  
Monomando lavabo, caño orientable, sin desagüe automático (con flex.).  
Комплект для раковины, поворотный излив, без донного клапана (с гибкими шлангами)

Articolo	Note	CROMO	CR	BR	O
7533		229,00	251,00	332,00	412,00
7533L	L	241,00	263,00	344,00	424,00
7533CE	CE	249,00	271,00	352,00	432,00
7533/S	S	329,00	351,00	432,00	512,00

**7533P**

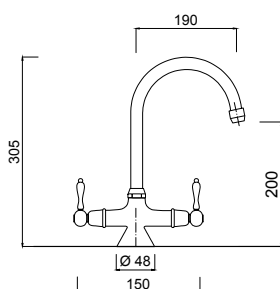

**Monoforo lavabo, bocca girevole, senza scarico (con flessibile).**  
Wash-basin set, swivel spout, without pop-up waste (with flexibles).  
Mélangeur lavabo monotrou, bec orientable, sans vidage (avec flexibles).  
Waschtischarmatur mit Schwenkauslauf, ohne Ablaufgarnitur (inkl. Anschlusschläuche).  
Monomando lavabo, caño orientable, sin desagüe automático (con flex.).  
Комплект для раковины, поворотный излив, без донного клапана (с гибкими шлангами)

Articolo	Note	CROMO	CR	BR	O
7533P		174,00	191,00	252,00	313,00
7533PL	L	186,00	203,00	264,00	325,00
7533PCE	CE	194,00	211,00	272,00	333,00
7533P/S	S	274,00	291,00	352,00	413,00

7537

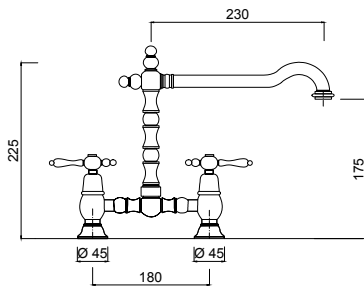

**Gruppo lavabo 2 fori, bocca girevole, senza scarico.**  
2-hole wash-basin set, swivel spout, without pop-up waste.  
Mélangeur lavabo 2 trous, bec orientable, sans vidage.  
2-Loch Waschtischbatterie mit Schwenkauslauf, ohne Ablaufgarnitur.  
Bimando lavabo 2 agujeros, caño orientable, sin desagüe automático.  
Комплект для раковины на 2 отверстия, поворотный излив, без донного клапана

Articolo	Note	CROMO	CR	BR	O
7537		292,00	321,00	423,00	525,00
7537L	L	304,00	333,00	435,00	537,00
7537CE	CE	312,00	341,00	443,00	545,00
7537/S	S	392,00	421,00	523,00	625,00

7537P

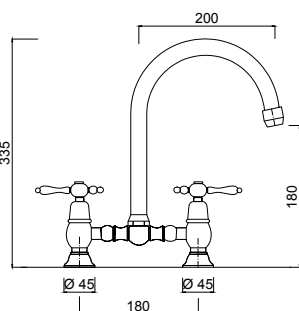

**Gruppo lavabo 2 fori, bocca girevole, senza scarico.**  
2-hole wash-basin set, swivel spout, without pop-up waste.  
Mélangeur lavabo 2 trous, bec orientable, sans vidage.  
2-Loch Waschtischbatterie mit Schwenkauslauf, ohne Ablaufgarnitur.  
Bimando lavabo 2 agujeros, caño orientable, sin desagüe automático.  
Комплект для раковины на 2 отверстия, поворотный излив, без донного клапана

Articolo	Note	CROMO	CR	BR	O
7537P		241,00	265,00	349,00	433,00
7537PL	L	253,00	277,00	361,00	445,00
7537PCE	CE	261,00	285,00	369,00	453,00
7537P/S	S	341,00	365,00	449,00	533,00

S7556AH

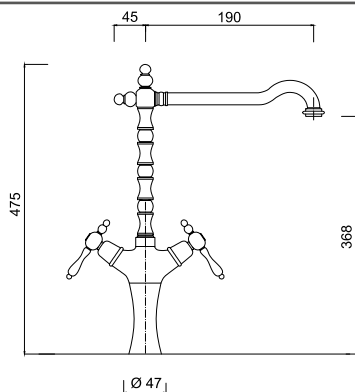

**Monoforo lavabo con prolunga, bocca girevole, scarico 1"1/4 (con flessibile).**  
Wash-basin mixer with extension, swivel spout, 1"1/4 pop-up waste (with flexibles).  
Mélangeur lavabo monotrou rehaussé, bec orientable, vidage 1"1/4 (avec flexibles).  
Hohe Waschtischarmatur mit Schwenkauslauf, Ablaufgarnitur 1"1/4 (inkl. Anschlussschläuche).  
Bimando lavabo alto, caño orientable, desagüe automático 1"1/4 (con flex.).  
Смеситель для раковины с удлинением, поворотным изливом, с донным клапаном на 1"1/4 (с гибкими шлангами)

Articolo	Note	CROMO	CR	BR	O
S7556AH		313,00	344,00	438,00	563,00
S7556AHL	L	325,00	356,00	450,00	575,00
S7556AHCE	CE	333,00	364,00	458,00	583,00
S7556AH/S	S	413,00	444,00	538,00	663,00

7522

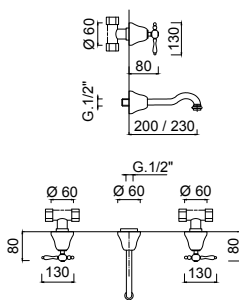

**Lavabo 3 fori a muro, bocca mm.200/230, senza scarico.**  
Wall-mounted 3-hole wash-basin set, spout mm 200/230, without pop-up waste.  
Mélangeur lavabo mural 3 trous, bec mm 200/230, sans vidage.  
3-Loch Waschtischarmatur für die Wandmontage, Auslauf mm 200/230, ohne Ablaufgarnitur.  
Bimando lavabo mural 3 agujeros, caño mm 200/230, sin desagüe automático.  
Комплект для раковины на 3 отверстия настенного монтажа, излив 200/230 мм., без донного клапана

Articolo	Note	CROMO	CR	BR	O
7522		209,00	229,00	293,00	376,00
7522L	L	221,00	241,00	305,00	388,00
7522CE	CE	229,00	249,00	313,00	396,00
7522/S	S	309,00	329,00	393,00	476,00

7523

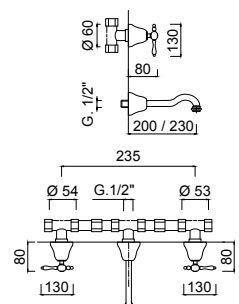

**Lavabo 3 fori a muro, bocca mm.200/230, senza scarico (con connessioni).**  
Wall-mounted 3-hole wash-basin set, spout mm 200/230, without pop-up waste (with connections).  
Mélangeur lavabo mural 3 trous, bec mm 200/230, sans vidage (avec les contacteurs).  
3-Loch Waschtischarmatur für die Wandmontage, Auslauf mm 200/230, ohne Ablaufgarnitur. (mit Verbindungen).  
Bimando lavabo mural 3 agujeros, caño mm 200/230, sin desagüe automático. (con conexiones).  
Комплект для раковины на 3 отверстия настенного монтажа, излив 200/230 мм., без донного клапана (с соединениями)

Articolo	Note	CROMO	CR	BR	O
7523		254,00	279,00	356,00	457,00
7523L	L	266,00	291,00	368,00	469,00
7523CE	CE	274,00	299,00	376,00	477,00
7523/S	S	354,00	379,00	456,00	557,00

### 7513A

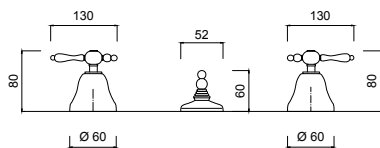

0101

#### Batteria bidet 3 fori, scarico 1"1/4.

3-hole bidet set, 1"1/4 pop-up waste.  
Mélangeur bidet 3 trous, vidage 1"1/4 (avec flexibles).  
3-Loch Bidetarmatur, Ablaufgarnitur 1"1/4.  
Grifo de bidé 3 agujeros, desagüe automático 1"1/4.  
Комплект для биде на 3 отверстия, донный клапан 1"1/4

Articolo	Note	CROMO	CR	BR	O
7513A		192,00	211,00	278,00	345,00
7513AL	L	204,00	223,00	290,00	357,00
7513ACE	CE	212,00	231,00	298,00	365,00
7513A/S	S	292,00	311,00	378,00	445,00

### 7545A

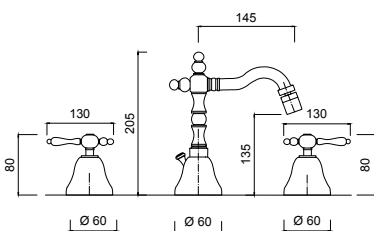

0101

#### Batteria bidet 3 fori, bocca girevole, scarico 1"1/4

3-hole bidet set, swivel spout, 1"1/4 pop-up waste.  
Mélangeur bidet à 3 trous, bec mobile, vidage automatique 1"1/4.  
Bidet-Dreilochbatterie, Rohrauslauf, Ablaufgarnitur 1"1/4.  
Bateria bidet, caño giratorio, tapón accionado por varilla 1"1/4.  
Комплект для биде на 3 отверстия, поворотный излив, донный клапан 1"1/4 (гибкая подводка).

Articolo	Note	CROMO	CR	BR	O
7545A		303,00	333,00	439,00	545,00
7545AL	L	315,00	345,00	451,00	557,00
7545ACE	CE	323,00	353,00	459,00	565,00
7545A/S	S	403,00	433,00	539,00	645,00

### S7558A

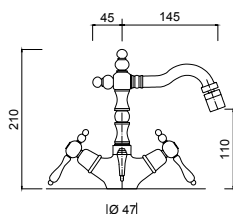

0102

#### Monoforo bidet, bocca girevole, scarico 1"1/4 (con flessibile)

Bidet unit, swivel spout, 1"1/4 pop-up waste (with flexible).  
Mélangeur monotrou bidet, bec mobile, vidage automatique 1"1/4 (avec flex.).  
Bidet-Einlochbatterie, Rohrauslauf, Ablaufgarnitur 1"1/4 (mit flexiblen Anschlusschläuchen).  
Monobloque bidet, caño giratorio, tapón accionado por varilla 1"1/4 (con flexible).  
Смеситель для биде, поворотный излив, донный клапан 1"1/4 (гибкая подводка).

Articolo	Note	CROMO	CR	BR	O
S7558A		220,00	242,00	308,00	396,00
S7558AL	L	232,00	254,00	320,00	408,00
S7558ACE	CE	240,00	262,00	328,00	416,00
S7558A/S	S	320,00	342,00	408,00	496,00

### SA7564

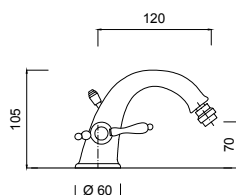

0102

#### Monoforo bidet, scarico 1"1/4 (con flessibile).

Bidet set, 1"1/4 pop-up waste (with flexibles).  
Mélangeur bidet monotrou, vidage 1"1/4 (avec flexibles).  
Bidetarmatur, Ablaufgarnitur 1"1/4 (inkl. Anschlusschläuche).  
Bimando bidé, desagüe automático 1"1/4 (con flex.).  
Комплект для биде, донный клапан 1"1/4 (с гибкими шлангами)

Articolo	Note	CROMO	CR	BR	O
SA7564		220,00	242,00	308,00	396,00
SA7564L	L	232,00	254,00	320,00	408,00
SA7564ACE	CE	240,00	262,00	328,00	416,00
SA7564/S	S	320,00	342,00	408,00	496,00

### 7535

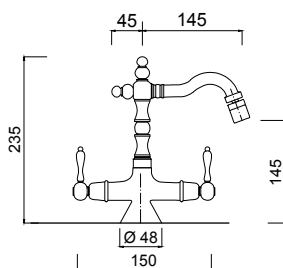

0102

#### Monoforo bidet, bocca girevole, senza scarico (con flessibile).

Bidet set, swivel spout, without pop-up waste (with flexibles).  
Mitigeur bidet monotrou, bec orientable, sans vidage (avec flexibles).  
Bidetarmatur mit Schwenkauslauf, ohne Ablaufgarnitur (inkl. Anschlusschläuche).  
Bimando bidé, caño orientable, sin desagüe automático (con flex.).  
Комплект для биде, поворотный излив, без донного клапана (с гибкими шлангами)

Articolo	Note	CROMO	CR	BR	O
7535		229,00	251,00	332,00	412,00
7535L	L	241,00	263,00	344,00	424,00
7535CE	CE	249,00	271,00	352,00	432,00
7535/S	S	329,00	351,00	432,00	512,00



**8213-PR**

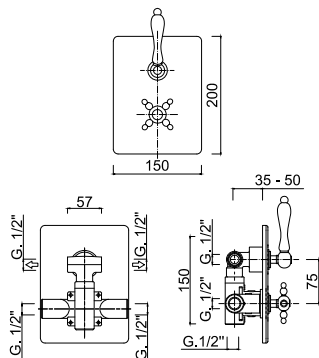

**Termostatico incasso 2 uscite**

2 outlets built-in thermostatic mixer  
Mitigeur thermostatique mural à 2 sorties  
2-Ausgänge eingebaute Einhebel-Thermostatbatterie  
Mezclador termostatico a empotrar a 2 salidas.  
Встроенный термостатический смеситель на 2 выхода

Articolo	Note	CROMO	CR	BR	O
8213-PR		530,00	583,00	742,00	848,00
8213-PRL	L	542,00	595,00	754,00	860,00
8213-PRCE	CE	550,00	603,00	762,00	868,00
8213-PR/S	S	630,00	683,00	842,00	948,00

**8282-PR**

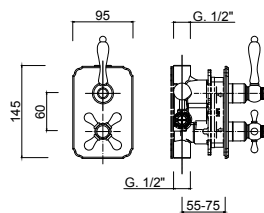
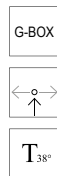

**Termostatico incasso 2 uscite, box incasso.**

Built-in thermostatic mixer with 2 outlets, built-in box.  
Mitigeur thermostatique douche à encastrer avec 2 sorties, box d'encastrement.  
UP-Thermostat mit 2-Wege-Umstellung, inkl. Box.  
Termostática empotrada 2 salidas, box empotrado incluido.  
Встраиваемый термостатический смеситель с 2 выходами, встраиваемый бокс

Articolo	Note	CROMO	CR	BR	O
8282-PR		840,00	882,00	1.092,00	1.260,00
8282-PRL	L	846,00	888,00	1.098,00	1.266,00
8282-PRCE	CE	850,00	892,00	1.102,00	1.270,00
8282-PR/S	S	890,00	932,00	1.142,00	1.310,00

**8283-PR**

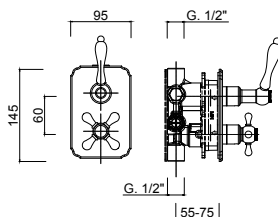
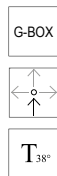

**Termostatico incasso 3 uscite, box incasso.**

Built-in thermostatic mixer with 3 outlets, built-in box.  
Mitigeur thermostatique douche à encastrer avec 3 sorties, box d'encastrement.  
UP-Thermostat mit 3-Wege-Umstellung, inkl. Box.  
Termostática empotrada 3 salidas, box empotrado incluido.  
Встраиваемый термостатический смеситель с 3 выходами, встраиваемый бокс

Articolo	Note	CROMO	CR	BR	O
8283-PR		890,00	934,00	1.157,00	1.335,00
8283-PRL	L	896,00	940,00	1.163,00	1.341,00
8283-PRCE	CE	900,00	944,00	1.167,00	1.345,00
8283-PR/S	S	940,00	984,00	1.207,00	1.385,00

**1716**

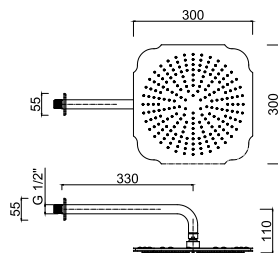

**Soffione con braccio doccia a parete.**

Shower head with shower arm.  
Pomme de douche avec bras de douche.  
Kopfbrause mit Wandarm.  
Rociador con brazo de ducha a pared.  
Верхний душ с держателем.

Articolo	Note	CROMO	CR	BR	O
1716		620,00	•	760,00	840,00

**1714-20**

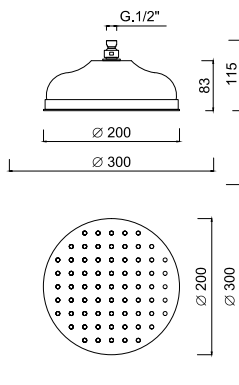

**Soffione doccia Ø 200.**

200 mm diameter shower head.  
Pomme de douche Ø 200 mm.  
Kopfbrause, Ø 200 mm.  
Alcachofa Ø 200 mm.  
Душевая лейка с защитой от известняка Ø 200.

Articolo	Note	CROMO	CR	BR	O
1714-20	mm 200	171,00	•	205,00	229,00
1714-30	mm 300	335,00	•	364,00	420,00



1751-35

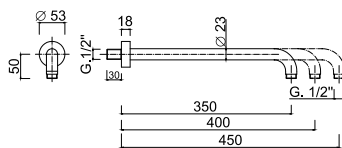

**Braccio doccia in ottone da mm 350.**  
Brass shower arm, length mm 350.  
Bras de douche, laiton chromé, longueur mm 350.  
Wandarm, mm 350 Länge, verchromtes Messing.  
Brazo ducha largo 350 mm, latón cromado.  
Душевой кронштейн из латуни, длина 350 мм.

Articolo	Note	CROMO	CR	BR	O
1751-35	mm 350	78,00	•	121,00	150,00
1751-40	mm 400	83,00	•	•	•
1751-45	mm 450	98,00	•	•	•

1757

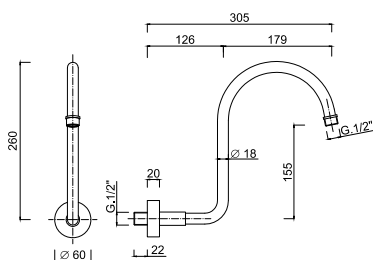

**Braccio doccia in ottone.**  
Brass shower arm.  
Bras de douche en laiton.  
Wandarm aus Messing.  
Brazo de ducha a pared en latón.  
Держатель для душа из латуни

Articolo	Note	CROMO	CR	BR	O
1757		98,00	•	135,00	163,00

1762-10

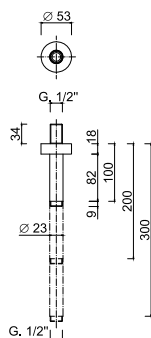

**Braccio doccia da soffitto mm.100.**  
Ceiling shower arm mm 100.  
Bras de douche vertical mm 100.  
Brausearm für Deckenmontage mm 100.  
Brazo de ducha a techo mm 100.  
Держатель душа 100 мм, потолочный

Articolo	Note	CROMO	CR	BR	O
1762-10	mm 100	52,00	•	78,00	102,00
1762-20	mm 200	61,00	•	•	•
1762-30	mm 300	70,00	•	•	•

1551

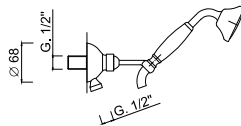

**Kit duplex incasso Praga.**  
Built-in duplex shower kit Praga.  
Ensemble de douche duplex à encaissement Praga.  
Einbaubrauseset Duplex Praga.  
Conjunto de ducha duplex para empotrar Praga.  
встроенный душевой набор "Duplex" Praga.

Articolo	Note	CROMO	CR	BR	O
1551		124,00	136,00	174,00	242,00
1551CE	CE	145,00	157,00	195,00	263,00

7507WS

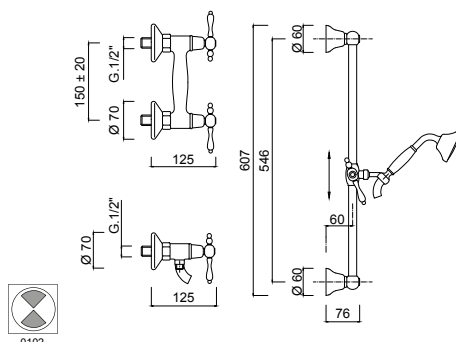

**Gruppo doccia esterno con saliscendi e doccia**  
External shower mixer with sliding rail set.  
mitigeur extérieur de douche avec barre coulissante et ensemble de douche.  
Aufputz-Brausebatterie mit Brausestange und Brauseset.  
Grupo ducha externo con conjunto ducha.  
Смеситель для душа внешнего монтажа с комплектом штанги для душа.

Articolo	Note	CROMO	CR	BR	O
7507WS		381,00	419,00	540,00	686,00
7507WSL	L	393,00	431,00	552,00	698,00
7507WSCE	CE	422,00	460,00	581,00	727,00
7507WS/S	S	481,00	519,00	640,00	786,00



**7507WC-S**

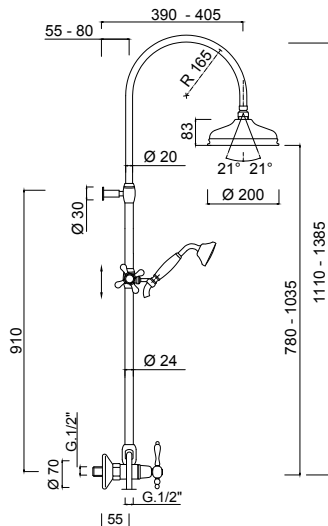

**Colonna doccia esterna, set doccia, soffione in ottone**  
 External shower column, shower kit, brass shower head.  
 Colonne de douche extérieure, ensemble de douche, pomme de douche en laiton.  
 Aufputz-Standbrause, Brauseset, Kopfbrause in Messing.  
 Columna ducha externa, conjunto de ducha, rociador en latón.  
 Душевая колонна внешнего монтажа, душевой набор, верхний душ из латуни

Articolo	Note	CROMO	CR	BR	O
<b>7507WC-S</b>		845,00	929,00	1.075,00	1.223,00
<b>7507WC-SL</b>	L	857,00	941,00	1.087,00	1.235,00
<b>7507WC-SCE</b>	CE	886,00	970,00	1.116,00	1.264,00
<b>7507WC-S/S</b>	S	945,00	1.029,00	1.175,00	1.323,00

**8209-PRWC-S**

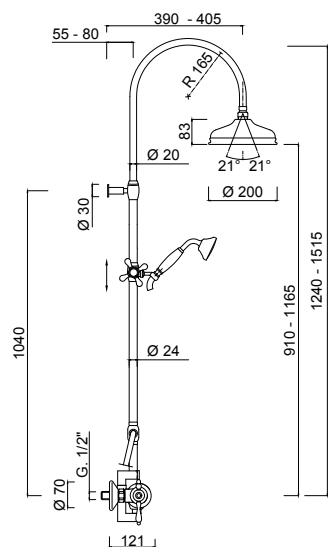

**Colonna doccia esterna termostatica, set doccia, soffione in ottone**  
 External thermostatic shower column, shower kit, brass shower head  
 Colonne de douche avec mélangeur thermostatique, ensemble de douche, pomme de douche en laiton  
 Aufputz- Standbrause mit Thermostat-Brausebatterie, Brauseset, Kopfbrause in Messing  
 Columna ducha con mezclador termostático, conjunto de ducha, rociador ducha en latón  
 Термостатическая душевая колонна внешнего монтажа, душевой набор, верхний душ из латуни

Articolo	Note	CROMO	CR	BR	O
<b>8209-PRWC-S</b>		1.331,00	1.464,00	1.701,00	1.928,00
<b>8209-PRWC-SL</b>	L	1.343,00	1.476,00	1.713,00	1.940,00
<b>8209-PRWC-SCE</b>	CE	1.351,00	1.484,00	1.721,00	1.948,00
<b>8209-PRWC-S/S</b>	S	1.431,00	1.564,00	1.801,00	2.028,00

7507

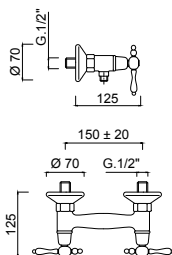

**Gruppo doccia esterno**

External shower mixer.  
Mitigeur extérieur de douche.  
Aufputz- Brausebatterie.  
Grupo ducha externo.  
Смеситель для душа внешнего монтажа

Articolo	Note	CROMO	CR	BR	O
7507		135,00	148,00	195,00	243,00
7507L	L	147,00	160,00	207,00	255,00
7507CE	CE	155,00	168,00	215,00	263,00
7507/S	S	235,00	248,00	295,00	343,00

8209-PR

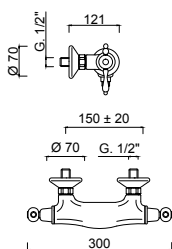

**Miscelatore termostatico doccia esterno.**

External shower thermostatic mixer.  
Mélangeur thermostatique pour douche.  
Thermostat-Brausebatterie.  
Mezclador termostático externo ducha.  
Термостатический смеситель для внешнего душа.

Articolo	Note	CROMO	CR	BR	O
8209-PR		443,00	465,00	598,00	730,00
8209-PRL	L	455,00	477,00	610,00	742,00
8209-PRCE	CE	463,00	485,00	618,00	750,00
8209PR/S	S	543,00	565,00	698,00	830,00

7500WC-S

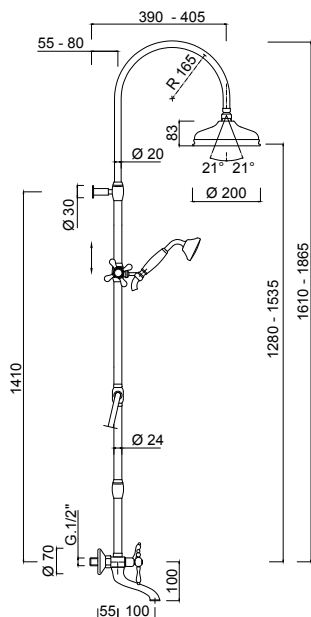

**Gruppo vasca esterno con colonna doccia, soffione ottone.**

Wall-mounted bath set with shower column and brass showerhead.  
Mélangeur bain-douche avec colonne de douche et pomme de douche en laiton.  
AP-Wannenbatterie mit Duschsäule, Kopfbrause aus Messing.  
Conjunto bañera de superficie, rociador en latón.  
Комплект для ванны настенного монтажа с душевой колонной и верхним душем из латуни

Articolo	Note	CROMO	CR	BR	O
7500WC-S		1.044,00	1.148,00	1.301,00	1.450,00
7500WC-SL	L	1.056,00	1.160,00	1.313,00	1.462,00
7500WC-SCE	CE	1.085,00	1.189,00	1.342,00	1.491,00
7500WC-S/S	S	1.144,00	1.248,00	1.401,00	1.550,00

7500CB

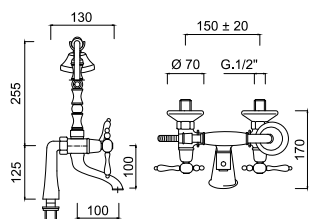

**Gruppo vasca esterno con set doccia, colonne bordo vasca.**

Wall-mounted bath set with shower kit, deck mounted tap legs.  
Mélangeur bain-douche avec ensemble de douche et colonnes sur gorge.  
AP-Wannenbatterie mit Brauseset, Standfüßen.  
Bimando bañera con kit de ducha, codos para batería de repisa.  
Комплект для ванны настенного монтажа с душевым набором, держатели для смесителя на край ванны

Articolo	Note	CROMO	CR	BR	O
7500CB		441,00	482,00	639,00	793,00
7500CBL	L	453,00	494,00	651,00	805,00
7500CBCE	CE	461,00	502,00	659,00	813,00
7500CB/S	S	541,00	582,00	739,00	893,00



7565

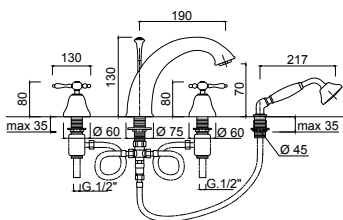

**Batteria bordo vasca 4 fori**

4-hole bath border set.  
Groupe mitigeur à 4 trous bord baignoire.  
4-Loch Wannen Kombination.  
Bateria borde bañera 4 agujeros.  
Комплект на борт ванны на 4 отверстия.

Articolo	Note	CROMO	CR	BR	O
7565		585,00	643,00	819,00	994,00
7565L	L	597,00	655,00	831,00	1.006,00
7565CE	CE	605,00	663,00	839,00	1.014,00
7565/S	S	685,00	743,00	919,00	1.094,00

7516

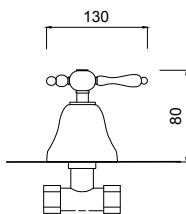

**Rubinetto incasso 1/2".**

1/2" built-in tap.  
Robinet d'arrêt à encastrer 3/4".  
UP-Absperventil 3/4".  
Llave de paso a empotrar 3/4".  
Встраиваемый кран 1/2"

Articolo	Note	CROMO	CR	BR	O
7516		77,00	84,00	111,00	138,00
7516L	L	83,00	90,00	117,00	144,00
7516CE	CE	87,00	94,00	121,00	148,00
7516/S		127,00	134,00	161,00	188,00

5102L

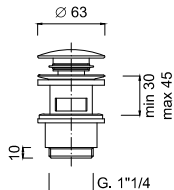

**Scarico per lavabo Up&Down 1"1/4.**

Basin drain 1"1/4 Up&Down.  
Vidage lavabo Up&Down 1"1/4.  
Ablaufgarnitur Up&Down 1"1/4.  
Desague automatico Up&Down 1"1/4.  
Слив для раковины Up&Down 1"1/4

Articolo	Note	CROMO	CR	BR	O
5102L		42,00	•	63,00	76,00

5009

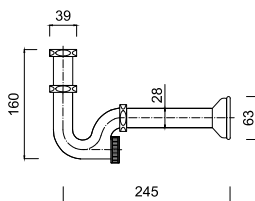

**Sifone per Lavabo 1"1/4.**

Trap for basin 1"1/4.  
Siphon lavabo 1"1/4.  
Messing Rohrsiphon 1"1/4 für Waschtisch  
Sifon para lavabo 1"1/4.  
Сифон для раковины 1"1/4

Articolo	Note	CROMO	CR	BR	O
5009		40,00	•	75,00	116,00

5009B

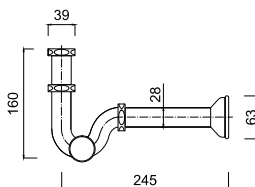

**Sifone per bidet 1"1/4.**

Brass basin trap 1"1/4.  
Siphon bidet laiton 1"1/4.  
Messing Rohrsiphon 1"1/4 für Bidet  
Sifon bidet en laiton 1"1/4.  
Сифон для умывальника из латуни 1"1/4.

Articolo	Note	CROMO	CR	BR	O
5009B		40,00	•	75,00	116,00



5011

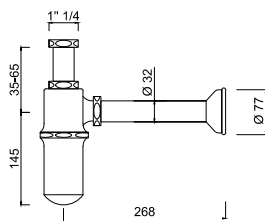

**Sifone 1" 1/4 a bottiglia.**  
*Bottle trap for basin 1" 1/4.*  
*Siphon bouteille pour lavabo 1"1/4.*  
*Tassensifon 1" 1/4 für Waschtisch.*  
*Sifón botella para lavabo 1"1/4.*  
*Сифон бутылка 1" 1/4.*

Articolo	Note	CROMO	CR	BR	O
5011		40,00	•	75,00	116,00

3063

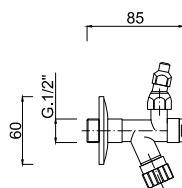

**Rubinetto con filtro con snodo.**  
*Tap with filter with articulated joint.*  
*Robinet d'arrêt avec filtre et coude*  
*Eckventil mit Filter*  
*Llave de regulaciòn con filtro*  
*Смеситель с фильтром и шарниром*

Articolo	Note	CROMO	CR	BR	O
3063		21,50	•	48,00	71,50

3262

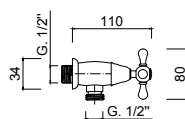

**Rubinetto sottolavabo.**  
*Angle valve.*  
*Robinet d'arrêt sous lavabo.*  
*Eckventil.*  
*Llave de paso.*  
*Вентиль под раковину*

Articolo	Note	CROMO	CR	BR	O
3262		52,00	•	70,00	90,00

1586

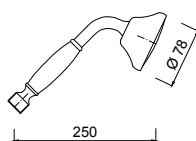

**Doccetta Praga.**  
*Praga hand-shower.*  
*Douchette Praga.*  
*Praga Handbrause.*  
*Ducha de teléfono Praga.*  
*Душевая лейка Praga.*

Articolo	Note	CROMO	CR	BR	O
1586		61,00	67,00	73,00	95,00
1586CE	CE	82,00	90,00	94,00	116,00

1585

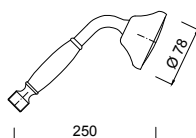

**Doccetta manopola ottone Londra**  
*Londra hand-shower brass handle.*  
*Douchette avec poignée en laiton Londra*  
*Londra Handbrause mit Griff aus Messing*  
*Ducha de teléfono empuñadura latón Londra*  
*Душевая лейка с ручкой из латуни Londra*

Articolo	Note	CROMO	CR	BR	O
1585		61,00	67,00	73,00	95,00



**PR1598**

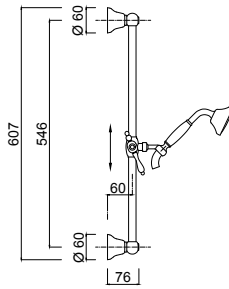

**Saliscendi maniglia Praga con doccia Praga.**  
Sliding bar with flexible hose and Praga handshower.  
Barre de douche avec flexible et douchette Praga.  
Brausegamitur mit Wandstange Praga.  
Barre deslizante cob flexible y ducha Praga.  
Душевая стойка Praga с ручкой Praga.

Articolo	Note	CROMO	CR	BR	O
<b>PR1598</b>		246,00	270,00	345,00	443,00
<b>PR1598L</b>	L	252,00	276,00	351,00	449,00
<b>PR1598CE</b>	CE	277,00	301,00	376,00	474,00
<b>PR1598/S</b>	S	296,00	320,00	395,00	493,00

**1510**

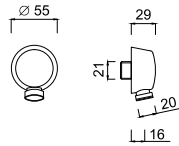

**Presca acqua 1/2"**  
Water plug 1/2"  
Prise d'eau mural 1/2"  
Wandanschlußbogen 1/2" für Brauseanschluß  
Toma de agua 1/2"  
Крепление к стене для гибкого шланга

Articolo	Note	CROMO	CR	BR	O
<b>1510</b>		16,00	•	24,00	33,00

**0128**



**Tubetto Ø 10 cm 35 con cartella e calotta.**  
Ø 10 cm 35 connection pipe with casing and cap.  
Tuyans Ø 10 cm 35 avec bordure.  
Gebogene Schläuche Ø 10 cm 35 mit Rand.  
Tubito Ø 10 cm 35 con revestimiento y casquete.  
Трубка Ø 10 cm 35 с креплением и колпаком.

Articolo	Note	CROMO	CR	BR	O
<b>0128</b>		7,20	•	13,00	18,00



**PRAGA**



**RESINA BIANCA**



**CE - CERAMICA BIANCA**



**CE - CERAMICA NERA**



**S - SWAROVSKI LIGHT**



**S - SWAROVSKI NERO**



**L - WENGÉ**



**L - TEAK**

**NOTE**

**Potete trovare altre soluzioni per la Doccia nell'area WELLNESS.**

For additional Shower options please go to WELLNESS section.

Pour plus de solutions pour la Douche visitez la section WELLNESS.

Für weitere Duschalternativen sehen Sie bitte in dem Kapitel WELLNESS nach.

Para más soluciones para Ducha visite la sección WELLNESS.

Другие решения для Душа вы найдёте в разделе Wellness.

p.374

**Per gli Accessori Bagno abbinati alla serie potete consultare la serie LILIUM - IBISCO CERMICA - IBISCO CRYSTAL.**

For matching Bathroom Fittings please check LILIUM - IBISCO CERMICA - IBISCO CRYSTAL. line.

Pour les Accessoires Salle de Bains coordonnés à la collection visitez la ligne LILIUM - IBISCO CERMICA - IBISCO CRYSTAL.

Die zu der Serie passenden Bad-Accessoires finden Sie in dem Linie LILIUM - IBISCO CERMICA - IBISCO CRYSTAL.

Para los Accesorios de Baño compatibles con la serie visite la línea LILIUM - IBISCO CERMICA - IBISCO CRYSTAL.

Чтобы подобрать подходящие аксессуары для ванной комнаты, перейдите в Линия LILIUM - IBISCO CERMICA - IBISCO CRYSTAL.

p.454 / 466



# PragaMix PragaMix Crystal

Crystals from Swarovski®









**RESINA BIANCA**  
White Resin  
Белый полимер



**CERAMICA BIANCA**  
White Ceramic  
Белая керамика



**CERAMICA NERA**  
Black Ceramic  
Черная керамика



**SWAROVSKI TRASPARENTE**  
Transparent Swarovski  
Прозрачный Swarovski



**SWAROVSKI NERO**  
Black Swarovski  
Черный Swarovski



**WENGÈ**  
Wengé  
Венге



**TEAK**  
Teck  
Тик



**7527A**

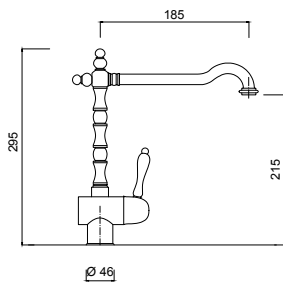

**Monocomando lavabo, bocca girevole, scarico 1"1/4 (con flessibile).**

Wash-basin mixer, swivel spout, 1"1/4 pop-up waste (with flexible).  
Mitigeur lavabo, bec mobile, vidage automatique 1"1/4 (avec flex.).  
Waschtisch-Einhebelmischer, Rohrauslauf, 1"1/4 Zugknopf Ablaufgarnitur (mit flexiblen Anschlusschläuchen).  
Monomando lavabo, caño giratorio, tapón accionado por varilla 1"1/4 (con flex.).  
Смеситель для раковины, поворотный излив, донный клапан 1"1/4 (гибкая подводка).

Articolo	Note	CROMO	AR-BR	O
7527A		227,00	329,00	408,00
7527AL	L	233,00	335,00	414,00
7527ACE	CE	237,00	339,00	418,00
7527A/S	S	277,00	379,00	458,00

**7527AH**

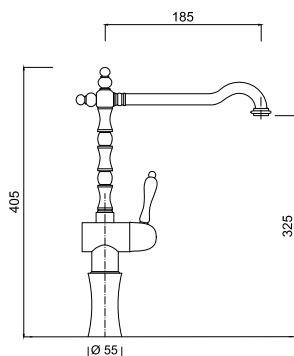

**Monocomando lavabo con prolunga, bocca girevole, scarico 1"1/4 (con flessibile)**

Wash-basin mixer with high and swivel spout, 1"1/4 pop-up waste (with flexible).  
Mitigeur lavabo avec bec haut et mobile, vidage automatique 1"1/4 (avec flex.).  
Waschtisch-Einhebelmischer mit hochgesetztem Rohrauslauf, 1"1/4 Zugknopf Ablaufgarnitur (mit flexiblen Anschlusschläuchen).  
Monomando lavabo con caño alto y giratorio, tapón accionado por varilla 1"1/4 (con flex.).  
Смеситель для раковины с высоким и поворотным изливом, донный клапан 1"1/4 (гибкая подводка).

Articolo	Note	CROMO	AR-BR	O
7527AH		293,00	424,00	527,00
7527AHL	L	299,00	430,00	533,00
7527AHCE	CE	303,00	434,00	537,00
7527AH/S	S	343,00	474,00	577,00

**7521**

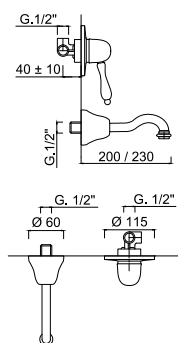
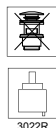

**Monocomando lavabo a muro, senza scarico**

Wall-mounted wash-basin set, without pop-up waste.  
Mitigeur lavabo mural, sans vidage.  
Waschtisch-Einhebelmischer Wandmontage, ohne Ablaufgarnitur.  
Monomando Lavabo de pared, sin desagüe.  
Комплект настенного монтажа для раковины, без донного клапана

Articolo	Note	CROMO	AR-BR	O
7521		145,00	210,00	261,00
7521L	L	151,00	216,00	267,00
7521CE	CE	155,00	220,00	271,00
7521/S	S	195,00	260,00	311,00

**7529A**

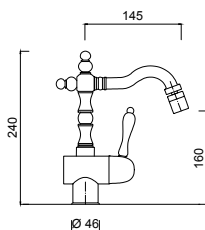

**Monocomando bidet, bocca girevole, scarico 1"1/4 (con flessibile)**

Bidet mixer, swivel spout, 1"1/4 pop-up waste (with flexible).  
Mitigeur bidet, bec mobile, vidage automatique 1"1/4 (avec flex.).  
Bidet-Einhebelmischer, Rohrauslauf, 1"1/4 Zugknopf Ablaufgarnitur (mit flexiblen Anschlusschläuchen).  
Monomando bidet, caño giratorio, tapón accionado por varilla 1"1/4 (con flex.).  
Смеситель для биде, поворотный излив, донный клапан 1"1/4 (гибкая подводка).

Articolo	Note	CROMO	AR-BR	O
7529A		227,00	329,00	408,00
7529AL	L	233,00	335,00	414,00
7529ACE	CE	237,00	339,00	418,00
7529A/S	S	277,00	379,00	458,00

**7515WB**

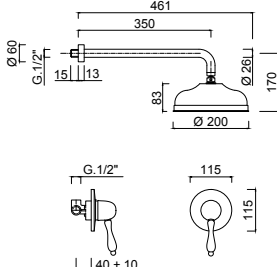
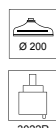

**Set doccia incasso monocomando, soffione ottone**

Shower built-in single-lever mixer, brass shower head.  
Mitigeur pour douche à encaissement, pomme de douche en laiton.  
Unterputz-Duscheneinhebelmischer mit Kopfbräuse, Kopfbräuse in Messing.  
Monomando ducha para empotrar, rociador en latón.  
Однорычажный встроенный смеситель для душа, верхний душ из латуны

Articolo	Note	CROMO	AR-BR	O
7515WB		336,00	450,00	533,00
7515WBL	L	342,00	456,00	539,00
7515WBCE	CE	346,00	460,00	543,00
7515WB/S	S	386,00	500,00	583,00



**7515WS**

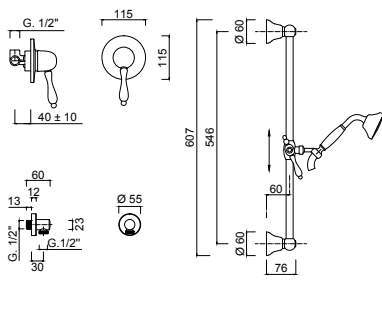

**Set doccia incasso monocomando, presa acqua, saliscendi.**

Built-in shower mixer, water plug, sliding rail.  
Mitigeur douche à encastrer, prise d'eau, barre de douche.  
UP-Einhebel-Brausemischer, Wandanschlussbogen, Brausestange.  
Monomando ducha empotrado, toma de agua, barra deslizante.  
Встраиваемый смеситель для душа, разъем для подачи воды, регулируемая штанга

Articolo	Note	CROMO	AR-BR	O
7515WS		348,00	493,00	630,00
7515WSL	L	354,00	499,00	636,00
7515WSCE	CE	358,00	503,00	640,00
7515WS/S	S	398,00	543,00	680,00

**7515WC-S**

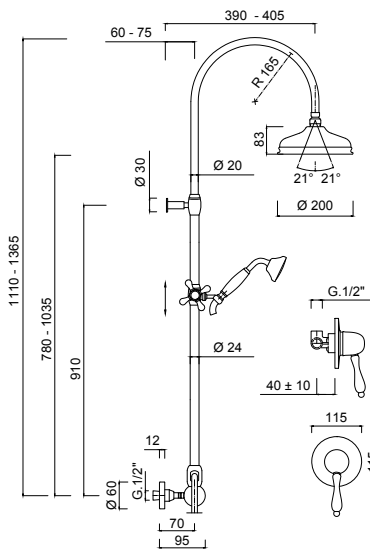

**Set doccia incasso monocomando, colonna doccia.**

Built-in shower mixer, shower column.  
Mitigeur douche à encastrer, colonne de douche.  
UP-Einhebel-Brausemischer, Duschsäule.  
Monomando ducha empotrado, columna de ducha.  
Встраиваемый смеситель для душа, душевая колонна

Articolo	Note	CROMO	AR-BR	O
7515WC-S		846,00	1.079,00	1.224,00
7515WC-SL	L	852,00	1.085,00	1.230,00
7515WC-SCE	CE	877,00	1.100,00	1.245,00
7515WC-S/S	S	896,00	1.129,00	1.274,00

**7511KB**

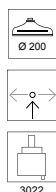
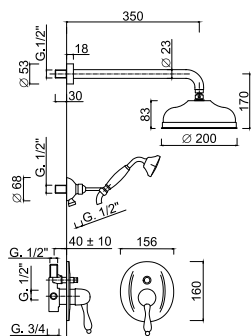

**Set doccia incasso monocomando con deviatore, soffione ottone, kit duplex incasso**

Shower built-in single-lever mixer with diverter, brass shower head, built-in duplex shower kit  
Mitigeur pour douche à encaissement avec inverseur, pomme de douche en laiton, ensemble de douche duplex à encaissement  
Unterputz-Duscheneinhebelmischer mit Umstellung, Brausekopf in Messing, Einbau-Brauseset Duplex  
Monomando ducha para empotrar con desviador, rociador ducha en latón, conjunto ducha duplex para empotrar  
Однорычажный встроенный смеситель для душа с дивертером, верхний душ из латуни, встроенный душевой набор "Duplex"

Articolo	Note	CROMO	AR-BR	O
7511KB		567,00	779,00	968,00
7511KBL	L	573,00	785,00	974,00
7511KBCE	CE	598,00	810,00	999,00
7511KB/S	S	617,00	829,00	1.018,00

**7515**

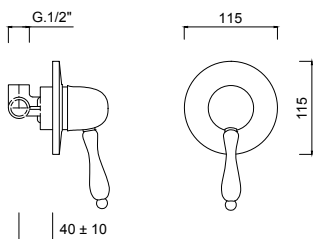

**Monocomando doccia incasso.**

Shower built-in single-lever mixer.  
Mitigeur pour douche à encaissement.  
Unterputz-Duscheneinhebelmischer.  
Monomando ducha para empotrar.  
Однорычажный встроенный смеситель для душа

Articolo	Note	CROMO	AR-BR	O
7515		91,00	124,00	154,00
7515L	L	97,00	130,00	160,00
7515CE	CE	101,00	134,00	164,00
7515/S	S	141,00	174,00	204,00

7511

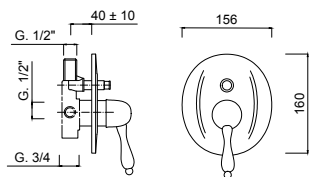
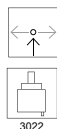

**Monocomando doccia incasso con deviatore**

Shower built-in single-lever mixer with diverter.  
Mitigeur pour douche à encaissement avec inverseur.  
Unterputz- Duscheneinhebelmischer mit Umstellung.  
Monomando ducha para empotrar con desviador.  
Однорычажный встроенный смеситель для душа с дивертером

Articolo	Note	CROMO	AR-BR	O
7511		193,00	279,00	347,00
7511L	L	199,00	285,00	353,00
7511CE	CE	203,00	289,00	520,00
7511/S	S	243,00	329,00	600,00

7511-3

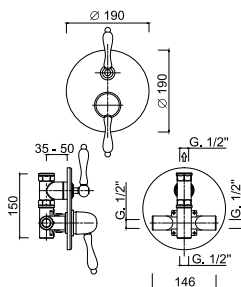
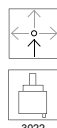

**Monocomando doccia incasso con deviatore 3 uscite**

Shower built-in single-lever mixer with 3 outlets diverter  
Mitigeur pour douche à encaissement avec inverseur à 3 sorties  
Unterputz- Duscheneinhebelmischer mit 3-Ausgänge Umstellung  
Monomando ducha para empotrar con desviador a 3 salidas  
Однорычажный встроенный смеситель для душа с дивертером на 3 выхода

Articolo	Note	CROMO	AR-BR	O
7511-3		287,00	403,00	500,00
7511-3L	L	290,00	415,00	512,00
7511-3CE	CE	298,00	423,00	520,00
7511-3/S	S	378,00	503,00	600,00

7511-4

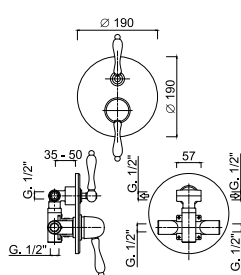
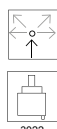

**Monocomando doccia incasso con deviatore 4 uscite**

Shower built-in single-lever mixer with 4 outlets diverter  
Mitigeur pour douche à encaissement avec inverseur à 4 sorties  
Unterputz- Duscheneinhebelmischer mit 4-Ausgänge Umstellung  
Monomando ducha para empotrar con desviador a 4 salidas  
Однорычажный встроенный смеситель для душа с дивертером на 4 выхода

Articolo	Note	CROMO	AR-BR	O
7511-4		295,00	428,00	531,00
7511-4L	L	307,00	440,00	543,00
7511-4CE	CE	315,00	448,00	551,00
7511-4/S	S	395,00	528,00	631,00

8212-PR

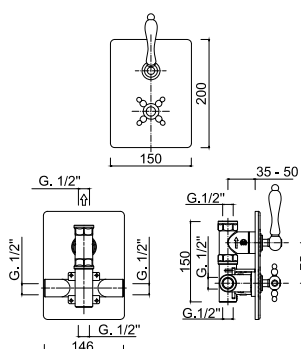

**Termostatico incasso 1/2", con rubinetto d'arresto 1/2".**

Built-in thermostatic mixer 1/2", with built-in tap 1/2".  
Mitigeur thermostatique mural, 1/2", avec robinet mural 1/2".  
Eingebaute Einhebel Thermostatbatterie 1/2", mit Ventil 1/2".  
Mezclador termostatico a empotrar 1/2", con grifo 1/2".  
Встраиваемый термостат 1/2" со встраиваемым смесителем 3/4".

Articolo	Note	CROMO	AR-BR	O
8212-PR		528,00	686,00	792,00
8212-PRL	L	540,00	698,00	804,00
8212-PRCE	CE	548,00	706,00	812,00
8212-PR/S	S	628,00	786,00	892,00

8213-PR

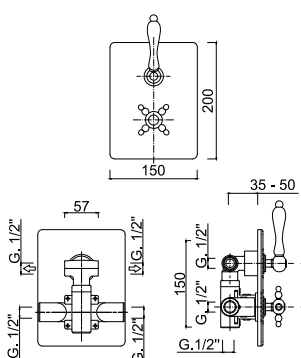
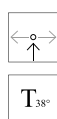

**Termostatico incasso 2 uscite**

2 outlets built-in thermostatic mixer  
Mitigeur thermostatique mural à 2 sorties  
2-Ausgänge eingebaute Einhebel-Thermostatbatterie  
Mezclador termostatico a empotrar a 2 salidas.  
Встроенный термостатический смеситель на 2 выхода

Articolo	Note	CROMO	AR-BR	O
8213-PR		583,00	757,00	874,00
8213-PRL	L	595,00	769,00	886,00
8213-PRCE	CE	603,00	777,00	894,00
8213-PR/S	S	683,00	857,00	974,00

**8282-PR**

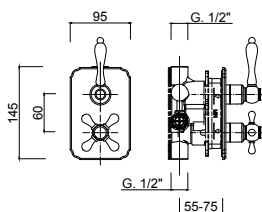
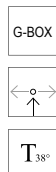

**Termostatico incasso 2 uscite, box incasso.**  
Built-in thermostatic mixer with 2 outlets, built-in box.  
Mitigeur thermostatique douche à encastrer avec 2 sorties, box d'encastrement.  
UP-Thermostat mit 2-Wege-Umstellung, inkl. Box.  
Termostática empotrada 2 salidas, box empotrado incluido.  
Встраиваемый термостатический смеситель с 2 выходами, встраиваемый бокс

Articolo	Note	CROMO	AR-BR	O
8282-PR		840,00	1.092,00	1.260,00
8282-PRL	L	846,00	1.098,00	1.266,00
8282-PRCE	CE	850,00	1.102,00	1.270,00
8282-PR/S	S	890,00	1.142,00	1.310,00

**8283-PR**

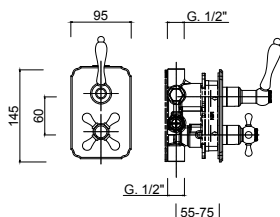
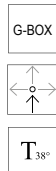

**Termostatico incasso 3 uscite, box incasso.**  
Built-in thermostatic mixer with 3 outlets, built-in box.  
Mitigeur thermostatique douche à encastrer avec 3 sorties, box d'encastrement.  
UP-Thermostat mit 3-Wege-Umstellung, inkl. Box.  
Termostática empotrada 3 salidas, box empotrado incluido.  
Встраиваемый термостатический смеситель с 3 выходами, встраиваемый бокс

Articolo	Note	CROMO	AR-BR	O
8283-PR		890,00	1.157,00	1.337,00
8283-PRL	L	896,00	1.163,00	1.341,00
8283-PRCE	CE	900,00	1.167,00	1.345,00
8283-PR/S	S	940,00	1.207,00	1.385,00

**1716**

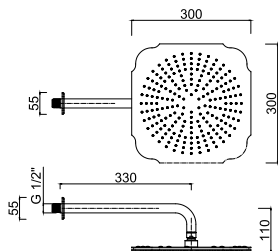

**Soffione con braccio doccia a parete.**  
Shower head with shower arm.  
Pomme de douche avec bras de douche.  
Kopfbrause mit Wandarm.  
Rociador con brazo de ducha a pared.  
Верхний душ с держателем.

Articolo	Note	CROMO	AR-BR	O
1716		620,00	760,00	840,00

**1714-20**

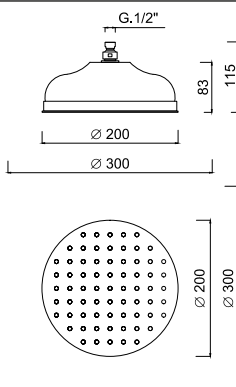

**Soffione doccia Ø 200.**  
200 mm diameter shower head.  
Pomme de douche Ø 200 mm.  
Kopfbrause, Ø 200 mm.  
Alcachofa Ø 200 mm.  
Душевая лейка с защитой от известняка Ø 200.

Articolo	Note	CROMO	AR-BR	O
1714-20		171,00	205,00	229,00
1714-30	CE	335,00	364,00	420,00

**1751-35**

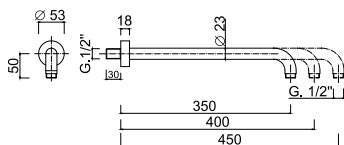

**Braccio doccia in ottone da mm 350.**  
Brass shower arm, length mm 350.  
Bras de douche, laiton chromé, longueur mm 350.  
Wandarm, mm 350 Länge, verchromtes Messing.  
Brazo ducha largo 350 mm, latón cromado.  
Душевой кронштейн из латуни, длина 350 мм.

Articolo	Note	CROMO	AR-BR	O
1751-35	mm 350	75,00	121,00	150,00
1751-40	mm 400	83,00	•	•
1751-45	mm 450	98,00	•	•



1757

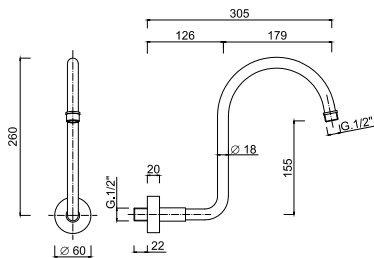

**Braccio doccia in ottone.**  
Brass shower arm.  
Bras de douche en laiton.  
Wandarm aus Messing.  
Brazo de ducha a pared en latón.  
Держатель для душа из латуны

Articolo	Note	CROMO	AR-BR	O
1757		98,00	135,00	163,00

1762-10

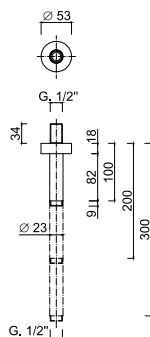

**Braccio doccia da soffitto mm.100.**  
Ceiling shower arm mm 100.  
Bras de douche vertical mm 100.  
Brausearm für Deckenmontage mm 100.  
Brazo de ducha a techo mm 100.  
Держатель душа 100 мм, потолочный

Articolo	Note	CROMO	AR-BR	O
1762-10	mm 100	52,00	78,00	102,00
1762-20	mm 200	61,00	•	•
1762-30	mm 300	70,00	•	•

1551

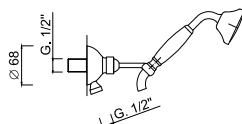

**Kit duplex incasso Praga.**  
Built-in duplex shower kit Praga.  
Ensemble de douche duplex à encaissement Praga.  
Einbaubrauseset Duplex Praga.  
Conjunto de ducha duplex para empotrar Praga.  
встроенный душевой набор "Duplex" Praga.

Articolo	Note	CROMO	AR-BR	O
1551		124,00	174,00	242,00
1551CE	CE	145,00	195,00	263,00

7524WS

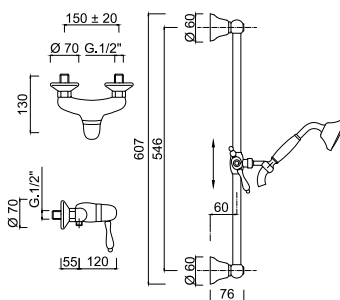

**Monocomando doccia esterno con saliscendi e doccia.**  
Single-lever shower mixer with sliding rail set.  
Mitigeur douche mural avec barre coulissante et ensemble de douche.  
Aufputz-Einhebelbrausebatterie mit Brausestange und Brauseset.  
Monomando ducha exterior con conjunto ducha.  
Однорычажный смеситель для душа с комплектом штанги для душа.

Articolo	Note	CROMO	AR-BR	O
7524WS		414,00	588,00	745,00
7524WSL	L	420,00	594,00	751,00
7524WSCE	CE	445,00	619,00	776,00
7524WS/S	S	464,00	638,00	795,00

**7524SWC-S**

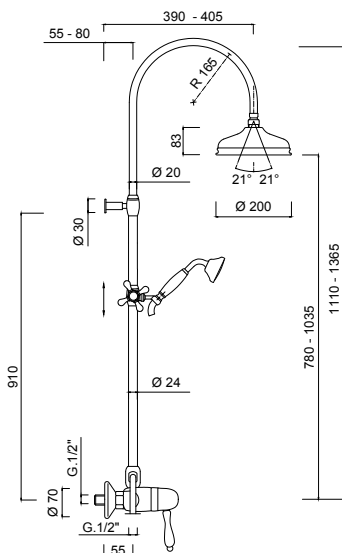

**Colonna doccia esterna monocomando, set doccia, soffione in ottone**

External single-lever shower mixer with shower column, shower kit, brass shower head.

Mitigeur de douche avec colonne de douche, ensemble de douche, pomme de douche en laiton.

Brausemischer mit Säulenbrause, Brauseset, Kopfbrause in Messing. Monomando con columna para ducha, conjunto de ducha, rociador en latón.

Однорычажный смеситель для душа внешнего монтажа с душевой колонной, душевой набор, верхний душ из латуни.

Articolo	Note	CROMO	AR-BR	O
<b>7524SWC-S</b>		878,00	1.123,00	1.282,00
<b>7524SWC-SL</b>	L	884,00	1.129,00	1.288,00
<b>7524SWC-SCE</b>	CE	909,00	1.154,00	1.313,00
<b>7524SWC-S/S</b>	S	928,00	1.175,00	1.332,00

**7524**

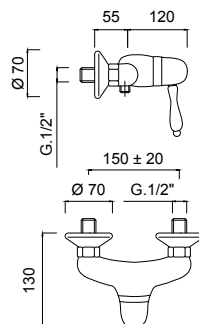

**Monocomando doccia esterno**

External single-lever shower mixer.

Mitigeur pour douche externe.

Aufputz-Einhebelbatterie.

Monomando ducha externo.

Однорычажный смеситель внешнего монтажа для душа.

Articolo	Note	CROMO	AR-BR	O
<b>7524</b>		168,00	243,00	302,00
<b>7524L</b>	L	174,00	249,00	308,00
<b>7524CE</b>	CE	178,00	253,00	312,00
<b>7524/S</b>	S	218,00	293,00	352,00

**7524S**

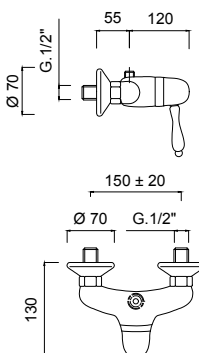

**Monocomando doccia esterno (attacco superiore)**

External single-lever shower mixer (upper connection).

Mitigeur douche (connection supérieure).

Aufputz-Brausemischer (oberer Anschluss).

Monomando para ducha (ataco superior).

Однорычажный смеситель для душа внешнего монтажа (подключение сверху)

Articolo	Note	CROMO	AR-BR	O
<b>7524S</b>		168,00	243,00	302,00
<b>7524SL</b>	L	174,00	249,00	308,00
<b>7524SCE</b>	CE	178,00	253,00	312,00
<b>7524S/S</b>	S	218,00	293,00	352,00

7510CT

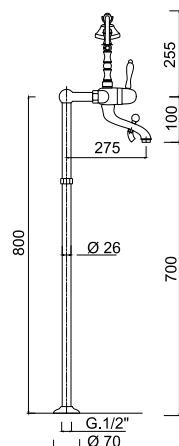

**Monocomando vasca esterno con set doccia duplex, colonne da terra.**

Wall-mounted bath mixer with duplex shower kit, deck mounted tap legs.

Mitigeur bain-douche avec ensemble de douche, sur colonnes au sol.

AP-Einhebel-Wannenmischer mit Brauseset, Standfüßen.

Monomando bañera con kit de ducha duplex, tomas de agua a suelo.

Смеситель для ванны настенного монтажа с душевым комплектом "duplex", держателями смесителя на край ванны

Articolo	Note	CROMO	AR-BR	O
7510CT		745,00	958,00	1.186,00
7510CTL	L	751,00	964,00	1.192,00
7510CTCE	CE	841,00	1.124,00	1.367,00
7510CT/S	S	795,00	1.008,00	1.236,00

7510

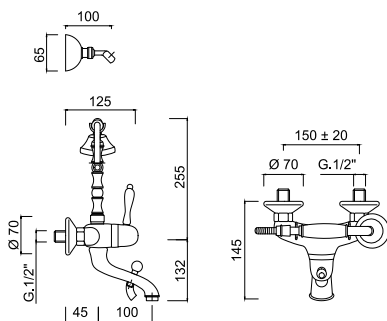

**Monocomando vasca esterno**

Wall-mounted bath mixer.

Mitigeur bain-douche.

AP-Einhebel-Wannenmischer.

Monomando bañera.

Смеситель для ванны настенного монтажа

Articolo	Note	CROMO	AR-BR	O
7510		320,00	448,00	576,00
7510L	L	326,00	454,00	582,00
7510CE	CE	383,00	541,00	664,00
7510/S	S	370,00	498,00	626,00

5102L

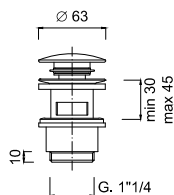

**Scarico per lavabo Up&Down 1"1/4.**

Basin drain 1"1/4 Up&Down.

Vidage lavabo Up&Down 1"1/4.

Ablaufgarnitur Up&Down 1"1/4.

Desague automatico Up&Down 1"1/4.

Слив для раковины Up&Down 1"1/4

Articolo	Note	CROMO	AR-BR	O
5102L		42,00	63,00	76,00

5009

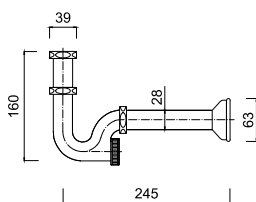

**Sifone per Lavabo 1"1/4.**

Trap for basin 1"1/4.

Siphon lavabo 1"1/4.

Messing Rohrsiphon 1"1/4 für Waschtisch

Sifón para lavabo 1"1/4.

Сифон для раковины 1"1/4

Articolo	Note	CROMO	AR-BR	O
5009		40,00	75,00	116,00

5009B

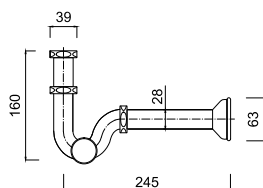

**Sifone per bidet 1"1/4.**  
Brass basin trap 1"1/4.  
Siphon bidet laiton 1"1/4.  
Messing Rohrsifon 1"1/4 für Bidet  
Sifón bidet en laiton 1"1/4.  
Сифон для умывальника из латуни 1"1/4.

Articolo	Note	CROMO	AR-BR	O	
5009B		40,00	75,00	116,00	

5011

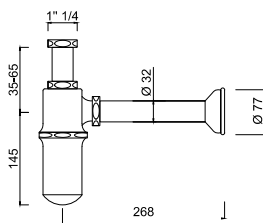

**Sifone 1" 1/4 a bottiglia.**  
Bottle trap for basin 1" 1/4.  
Siphon bouteille pour lavabo 1"1/4.  
Tassensifon 1" 1/4 für Waschtisch.  
Sifón botella para lavabo 1"1/4.  
Сифон бутылка 1" 1/4.

Articolo	Note	CROMO	AR-BR	O	
5011		40,00	75,00	116,00	

3063

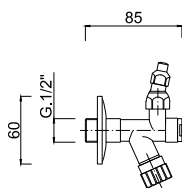

**Rubinetto con filtro con snodo.**  
Tap with filter with articulated joint.  
Robinet d'arrêt avec filtre et coude  
Eckventil mit Filter  
Llave de regulación con filtro  
Смеситель с фильтром и шарниром

Articolo	Note	CROMO	AR-BR	O	
3063		21,50	48,00	71,50	

3262

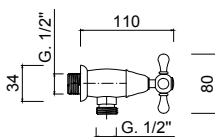

**Rubinetto sottolavabo.**  
Angle valve.  
Robinet d'arrêt sous lavabo.  
Eckventil.  
Llave de paso.  
Вентиль под раковину

Articolo	Note	CROMO	AR-BR	O	
3262		52,00	70,00	90,00	

1586

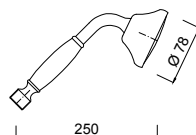

**Doccetta Praga.**  
Praga hand-shower.  
Douchette Praga.  
Praga Handbrause.  
Ducha de teléfono Praga.  
Душевая лейка Praga.

Articolo	Note	CROMO	AR-BR	O	
1586		61,00	73,00	95,00	
1586CE	CE	82,00	94,00	116,00	



1585

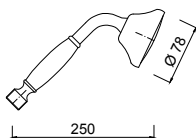

**Doccetta manopola ottone Londra.**  
Londra hand-shower brass handle.  
Douchette avec poignée en laiton Londra.  
Londra Handbrause mit Griff aus Messing.  
Ducha de teléfono empuñadura latón Londra.  
Душевая лейка с ручкой из латуни Londra.

Articolo	Note	CROMO	AR-BR	O
1585		61,00	73,00	95,00

PR1598

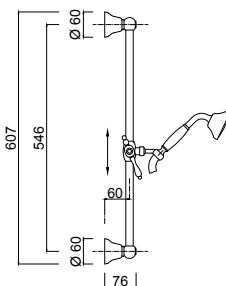

**Saliscendi maniglia Praga con doccia Praga.**  
Sliding bar with flexible hose and Praga handshower.  
Barre de douche avec flexible et douchette Praga.  
Brausegarnitur mit Wandstange Praga.  
Barre deslizante cob flexible y ducha Praga.  
Душевая стойка Praga с ручкой Praga.

Articolo	Note	CROMO	AR-BR	O
PR1598		246,00	345,00	443,00
PR1598L	L	252,00	351,00	449,00
PR1598CE	CE	277,00	376,00	474,00
PR1598/S	S	296,00	395,00	493,00

1510

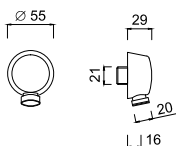

**Preso acqua 1/2"**  
Water plug 1/2"  
Prise d'eau mural 1/2"  
Wandanschlußbogen 1/2" für Brauseanschluß  
Toma de agua 1/2"  
Крепление к стене для гибкого шланга

Articolo	Note	CROMO	AR-BR	O
1510		16,00	24,00	33,00



PRAGAMIX



RESINA BIANCA



CE - CERAMICA BIANCA



CE - CERAMICA NERA



S - SWAROVSKI LIGHT



S - SWAROVSKI NERO



L - WENGÉ



L - TEAK

NOTE

**Potete trovare altre soluzioni per la Doccia nell'area WELLNESS.**

For additional Shower options please go to WELLNESS section.

Pour plus de solutions pour la Douche visitez la section WELLNESS.

Für weitere Duschalternativen sehen Sie bitte in dem Kapitel WELLNESS nach.

Para más soluciones para Ducha visite la sección WELLNESS.

Другие решения для Душа вы найдете в разделе Wellness.

p.374

**Per gli Accessori Bagno abbinati alla serie potete consultare la serie LILIUM - IBISCO CERMICA - IBISCO CRYSTAL.**

For matching Bathroom Fittings please check LILIUM - IBISCO CERMICA - IBISCO CRYSTAL line.

Pour les Accessoires Salle de Bains coordonnés à la collection visitez la ligne LILIUM - IBISCO CERMICA - IBISCO CRYSTAL..

Die zu der Serie passenden Bad-Accessoires finden Sie in dem Linie LILIUM - IBISCO CERMICA - IBISCO CRYSTAL..

Para los Accesorios de Baño compatibles con la serie visite la línea LILIUM - IBISCO CERMICA - IBISCO CRYSTAL..

Чтобы подобрать подходящие аксессуары для ванной комнаты, перейдите в Линия LILIUM - IBISCO CERMICA - IBISCO CRYSTAL.

p.454 / 466

# Persia Crystal

# Persia

Crystals from Swarovski®





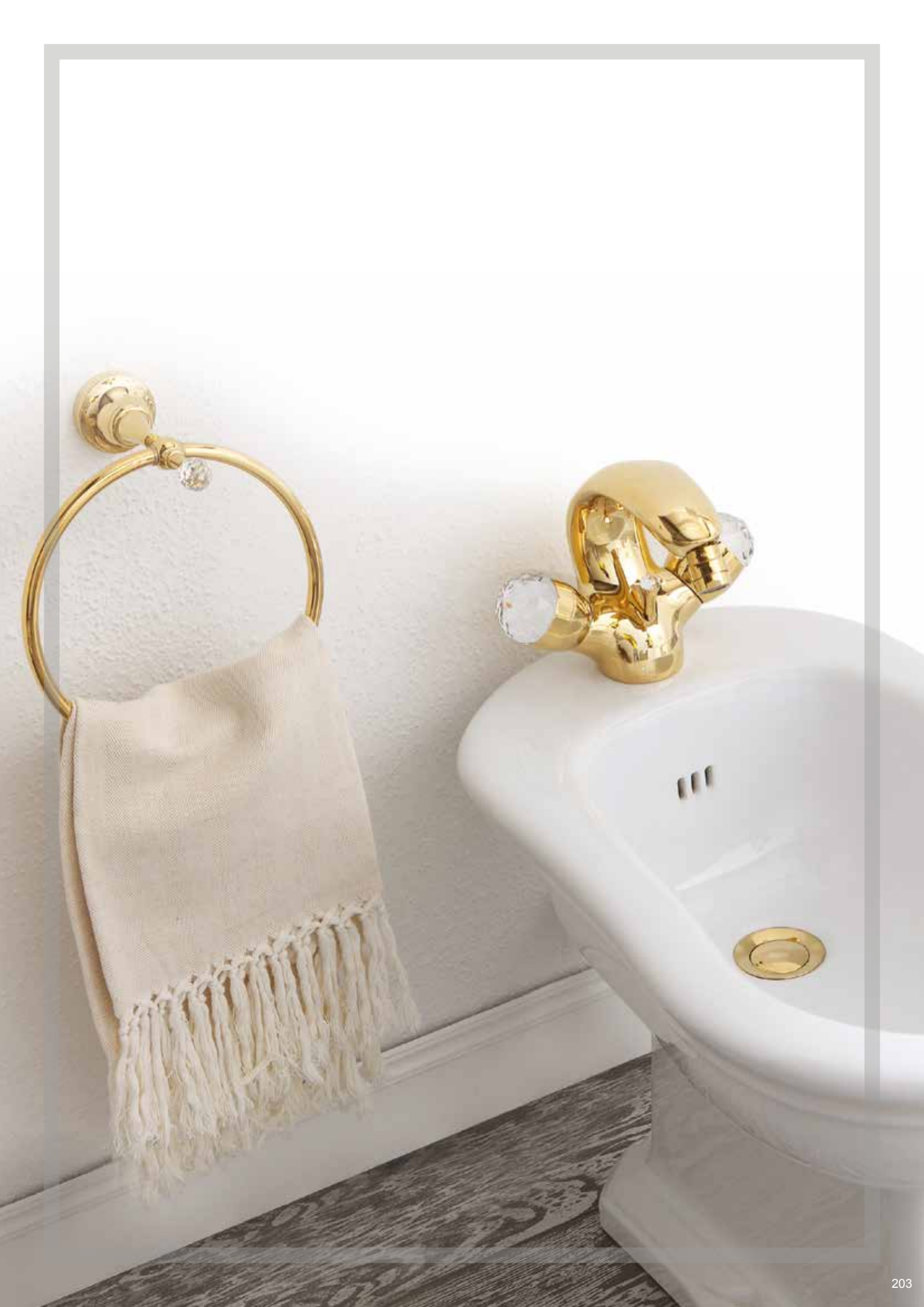

### 3812A/S

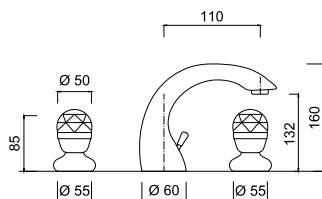

**Batteria lavabo 3 fori, scarico 1"1/4**  
3-hole wash-basin set, 1"1/4 pop-up waste.  
Mélangeur lavabo à trois trous, vidage automatique 1"1/4.  
Waschtisch-Dreilochbatterie, Ablaufgarnitur 1"1/4.  
Batería lavabo con 3 agujeros, tapón accionado por varilla 1"1/4.  
Комплект для раковины на 3 отверстия, донный клапан 1"1/4.

Articolo	Note	CROMO	CR	O
<b>3812A/S</b>		534,00	587,00	854,00
<b>3812A</b>	P	430,00	487,00	758,00

### S3861A/S

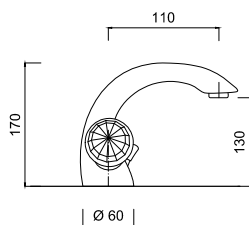

**Monoforo lavabo, scarico 1"1/4 (con flessibile).**  
Wash-basin unit, 1"1/4 pop-up waste (with flexible).  
Mélangeur monotrou lavabo, vidage automatique 1"1/4 (avec flex.)  
Waschtisch-Einlochbatterie, Ablaufgarnitur 1"1/4 (mit flexiblen Anschlussschläuchen).  
Monobloque lavabo, tapón accionado por varilla 1"1/4 (con flexible).  
Смеситель для раковины, донный клапан 1"1/4 (гибкая подводка).

Articolo	Note	CROMO	CR	O
<b>S3861A/S</b>		488,00	536,00	780,00
<b>S3861A</b>	P	384,00	436,00	684,00

### 3813A/S

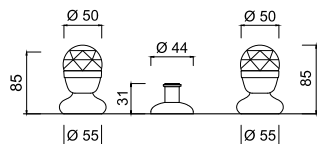

**Batteria bidet 3 fori, scarico 1"1/4**  
3-hole bidet set, 1"1/4 pop-up waste.  
Mélangeur bidet à 3 trous, vidage automatique 1"1/4.  
Bidet-Dreilochbatterie, Ablaufgarnitur 1"1/4.  
Batería bidet, tapón accionado por varilla 1"1/4.  
Комплект для биде на 3 отверстия, донный клапан 1"1/4 (гибкая подводка).

Articolo	Note	CROMO	CR	O
<b>3813A/S</b>		391,00	430,00	626,00
<b>3813A</b>	P	287,00	330,00	530,00

### S3864A/S

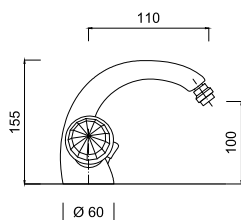

**Monoforo bidet, scarico 1"1/4 (con flessibile)**  
Bidet unit, 1"1/4 pop-up waste (with flexible).  
Mélangeur monotrou bidet, vidage automatique 1"1/4 (avec flex.)  
Bidet-Einlochbatterie, Ablaufgarnitur 1"1/4 (mit flexiblen Anschlussschläuchen).  
Monobloque bidet, tapón accionado por varilla 1"1/4 (con flexible).  
Смеситель для биде, донный клапан 1"1/4 (гибкая подводка).

Articolo	Note	CROMO	CR	O
<b>S3864A/S</b>		472,00	519,00	755,00
<b>A3864A</b>	P	368,00	419,00	659,00

### 3815W2KS/S

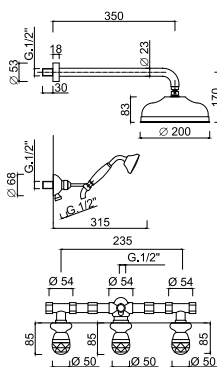

#### Set doccia incasso con deviatore 2 vie, soffione ottone, kit duplex incasso

Concealed shower taps with 2 ways diverter, brass shower head, built-in duplex shower kit

Mélangeur douche encastré avec inverseur à 2 voies, pomme de douche en laiton, ensemble de douche duplex à encaissement

Unterputz-Brausebatterie mit 2-Wage-Umstellung, Brausekopf in Messing, Einbau-Brausekit Duplex.

Grupo ducha empotrar con desviador 2 salidas, rociador ducha en latón, conjunto ducha duplex para empotrar

Встроенные краны для душа с дивертером на 2 выхода, верхний душ из латуни, встроенный душевой набор "Duplex"

Articolo	Note	CROMO	CR	O
3815W2KS/S		937,00	1.030,00	1.499,00
3815W2KS	P	781,00	1.355,00	1.355,00

### 3815W2/S

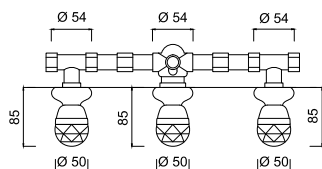
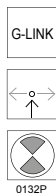

#### Rubinetti incasso doccia e deviatore 2 uscite.

Concealed shower taps and 2 outlets diverter.

Mélangeur douche encastré et inverseur 2 sorties.

Unterputz-Brausebatterie mit 2-Ausgänge Umstellung.

Grupo ducha empotrar y desviador 2 salidas.

Встроенные краны для душа и дивертер на 2 выхода.

Articolo	Note	CROMO	CR	O
3815W2/S		563,00	619,00	901,00
3815W2	P	407,00	469,00	757,00

### 3815W3/S

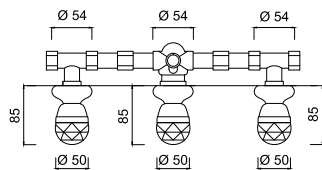
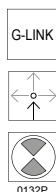

#### Rubinetti incasso doccia e deviatore 3 uscite.

Concealed shower taps and 3 outlets diverter.

Mélangeur douche encastré et inverseur 3 sorties.

Unterputz-Brausebatterie mit 3-Ausgänge Umstellung.

Grupo ducha empotrar y desviador 3 salidas.

Встроенные краны для душа и дивертер на 3 выхода

Articolo	Note	CROMO	CR	O
3815W3/S		580,00	638,00	928,00
3815W3		424,00	488,00	784,00

### 3807WS/S

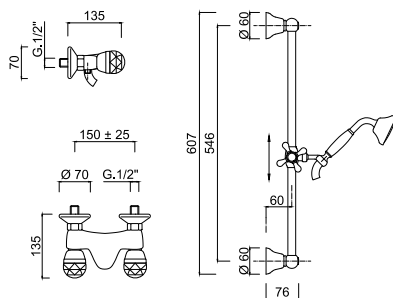

#### Gruppo doccia esterno con saliscendi e doccia

External shower mixer with sliding rail set.

mitigeur extérieur de douche avec barre coulissante et ensemble de douche.

Aufputz-Brausebatterie mit Brausestange und Brausekit.

Grupo ducha externo con conjunto ducha.

Смеситель для душа внешнего монтажа с комплектом штанги для душа.

Articolo	Note	CROMO	CR	O
3807WS/S		639,00	705,00	1.022,00
3807WS	P	535,00	605,00	926,00

**3807/S**

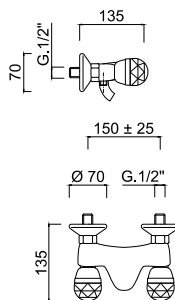

**Gruppo doccia esterno**

External shower mixer.  
Mitigeur extérieur de douche.  
Aufputz- Brausebatterie.  
Grupo ducha externo.  
Смеситель для душа внешнего монтажа

Articolo	Note	CROMO	CR	O
<b>3807/S</b>		392,00	431,00	627,00
<b>3807</b>	P	288,00	331,00	531,00

**3801/S**

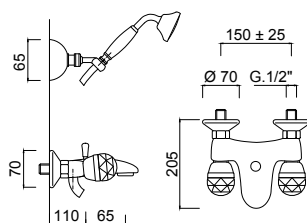

**Gruppo vasca esterno con set doccia duplex**

External bathtub set with duplex shower kit.  
Mélangeur bain-douche extérieur avec ensemble de douche duplex.  
Wannenbatterie mit Schlauch-Handbrause und verstellbarem Wandhalter.  
Grupo bañera externo con conjunto de ducha duplex.  
Комплект для ванны внешнего монтажа с душевым набором "Duplex."

Articolo	Note	CROMO	CR	O
<b>3801/S</b>		608,00	668,00	973,00
<b>3801</b>	P	504,00	658,00	877,00

**3860/S**

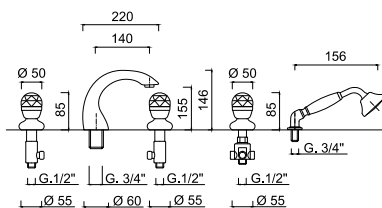

**Batteria bordo vasca 5 fori**

5-hole bath border set.  
Groupe mitigeur à 5 trous bord baignoire.  
5-Loch Wannen Kombination.  
Bateria borde bañera 5 agujeros.  
Комплект на борт ванны на 5 отверстий.

Articolo	Note	CROMO	CR	O
<b>3860/S</b>		1.030,00	1.133,00	1.648,00
<b>3860</b>	P	874,00	983,00	1.504,00

**3865/S**

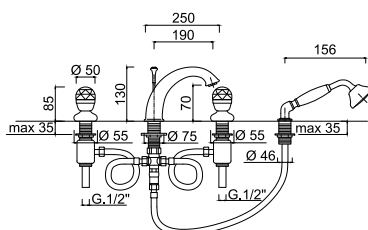

**Batteria bordo vasca 4 fori, bocca con deviatore.**

4-hole deck mounted set, spout with diverter.  
Mélangeur bain-douche sur gorge 4 trous, bec avec inverseur.  
4-Loch Wannenrandarmatur, Auslauf mit Umsteller.  
Grifo bañera de repisa 4 agujeros, caño con inversor.  
Комплект на 4 отверстия на край ванны, излив с дивертером

Articolo	Note	CROMO	CR	O
<b>3865/S</b>		750,00	825,00	1.200,00
<b>3865</b>	P	646,00	725,00	1.104,00



3816/S

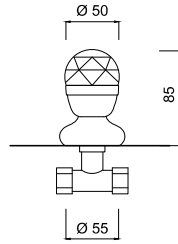

**Rubinetto incasso 1/2".**  
1/2" built-in tap.  
Robinet à encaissement 1/2".  
UP-Ventil 1/2".  
Grifo para empotrar 1/2".  
Вентиль встроенный 1/2".



Articolo	Note	CROMO	CR	O	
<b>3816/S</b>		165,00	181,00	264,00	
<b>3816</b>	P	113,00	131,00	216,00	



PERSIA

**NOTE**

**Potete trovare altre soluzioni per la Doccia nell'area WELLNESS.** p.374  
For additional Shower options please go to WELLNESS section.  
Pour plus de solutions pour la Douche visitez la section WELLNESS.  
Für weitere Duschalternativen sehen Sie bitte in dem Kapitel WELLNESS nach.  
Para más soluciones para Ducha visite la sección WELLNESS.  
Другие решения для Душа вы найдете в разделе Wellness.

**Per gli Accessori Bagno abbinati alla serie potete consultare la serie IBISCO CRYSTAL.** p.454  
For matching Bathroom Fittings please check IBISCO CRYSTAL. line.  
Pour les Accessoires Salle de Bains coordonnés à la collection visitez la ligne IBISCO CRYSTAL.  
Die zu der Serie passenden Bad-Accessoires finden Sie in dem Linie IBISCO CRYSTAL.  
Para los Accesorios de Baño compatibles con la serie visite la línea IBISCO CRYSTAL.  
Чтобы подобрать подходящие аксессуары для ванной комнаты, перейдите в Линия IBISCO CRYSTAL.



# Odessa Crystal

Crystals from Swarovski®





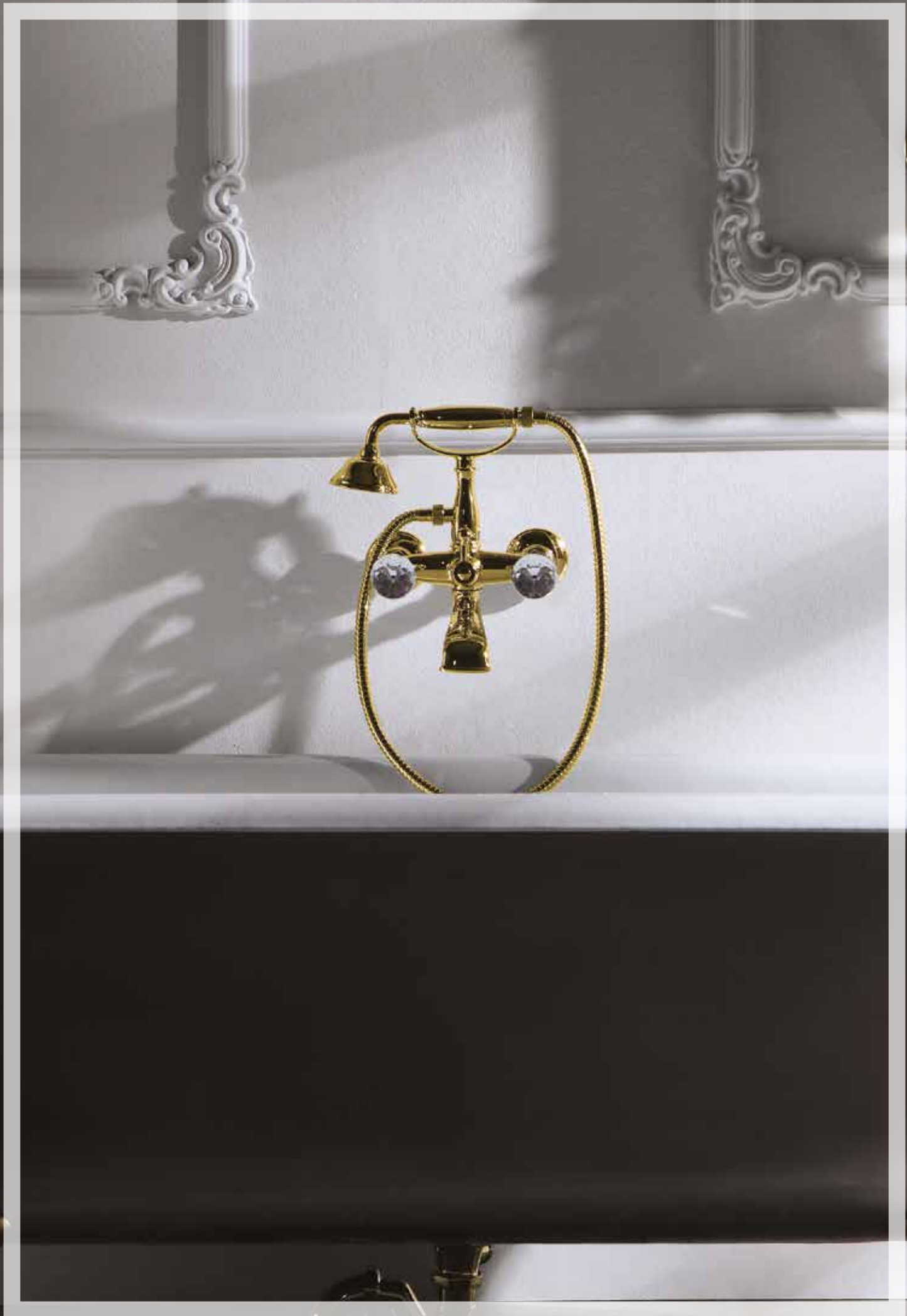

**3912A/S**

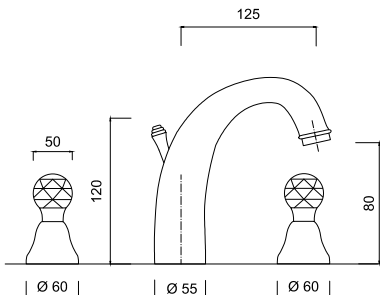

**Batteria lavabo 3 fori, scarico 1"1/4**  
3-hole wash-basin set, 1"1/4 pop-up waste.  
Mélangeur lavabo à trois trous, vidage automatique 1"1/4.  
Waschtisch-Dreilochbatterie, Ablaufgarnitur 1"1/4.  
Bateria lavabo con 3 agujeros, tapón accionado por varilla 1"1/4.  
Комплект для раковины на 3 отверстия, донный клапан 1"1/4.

Articolo	Note	CROMO	BR	O
3912A/S		495,00	614,00	742,00

**3906A/S**

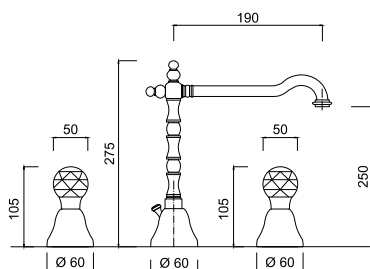

**Batteria lavabo 3 fori, bocca girevole scarico 1"1/4**  
3-hole wash-basin set, swivel spout, 1"1/4 pop-up waste.  
Mélangeur lavabo à trois trous, bec mobile, vidage automatique 1"1/4.  
Waschtisch-Dreilochbatterie, Rohrauslauf, Ablaufgarnitur 1"1/4.  
Bateria lavabo con 3 agujeros, caño giratorio, tapón accionado por varilla 1"1/4.  
Комплект для раковины на 3 отверстия, поворотный излив, донный клапан 1"1/4.

Articolo	Note	CROMO	BR	O
3906A/S		518,00	648,00	798,00

**3923/S**

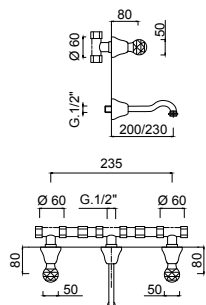

**Lavabo 3 fori a muro, bocca mm.200/230, senza scarico (con connessioni).**  
Wall-mounted 3-hole wash-basin set, spout mm 200/230, without pop-up waste (with connections).  
Mélangeur lavabo mural 3 trous, bec mm 200/230, sans vidage (avec les contacteurs).  
3-Loch Waschtischarmatur für die Wandmontage, Auslauf mm 200/230, ohne Ablaufgarnitur. (mit Verbindungen).  
Bimando lavabo mural 3 agujeros, caño mm 200/230, sin desagüe automático. (con conexiones).  
Комплект для раковины на 3 отверстия настенного монтажа, излив 200/230 мм., без донного клапана (с соединениями)

Articolo	Note	CROMO	BR	O
3923/S		425,00	508,00	591,00

**S3961A/S**

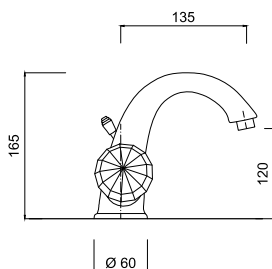

**Monoforo lavabo, scarico 1"1/4 (con flessibile).**  
Wash-basin unit, 1"1/4 pop-up waste (with flexible).  
Mélangeur monotrou lavabo, vidage automatique 1"1/4 (avec flex.)  
Waschtisch-Einlochbatterie, Ablaufgarnitur 1"1/4 (mit flexiblen Anschlussschläuchen).  
Monobloque lavabo, tapón accionado por varilla 1"1/4 (con flexible).  
Смеситель для раковины, донный клапан 1"1/4 (гибкая подводка).

Articolo	Note	CROMO	BR	O
S3961A/S		450,00	562,00	666,00

**3945A/S**

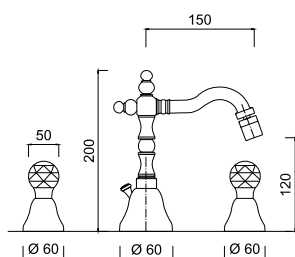

**Batteria bidet 3 fori, bocca girevole, scarico 1"1/4**  
3-hole bidet set, swivel spout, 1"1/4 pop-up waste.  
Mélangeur bidet à 3 trous, bec mobile, vidage automatique 1"1/4.  
Bidet-Dreilochbatterie, Rohrauslauf, Ablaufgarnitur 1"1/4.  
Bateria bidet, caño giratorio, tapón accionado por varilla 1"1/4.  
Комплект для биде на 3 отверстия, поворотный излив, донный клапан 1"1/4 (гибкая подводка).

Articolo	Note	CROMO	BR	O
3945A/S		515,00	655,00	792,00

**S3964A/S**

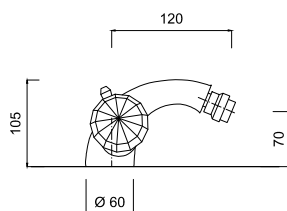

**Monoforo bidet, scarico 1"1/4 (con flessibile)**

Bidet unit, 1"1/4 pop-up waste (with flexible).  
Mélangeur monotrou bidet, vidage automatique 1"1/4 (avec flex.)  
Bidet-Einlochbatterie, Ablaufgarnitur 1"1/4 (mit flexiblen Anschlussschläuchen).  
Monobloque bidet, tapón accionado por varilla 1"1/4 (con flexible).  
Смеситель для биде, донный клапан 1"1/4 (гибкая подводка).

Articolo	Note	CROMO	BR	O
<b>3964A/S</b>		450,00	562,00	666,00

**3915W2/S**

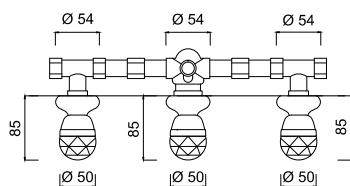

**Rubinetti incasso doccia e deviatore 2 uscite.**

Concealed shower taps and 2 outlets diverter.  
Mélangeur douche encastré et inverseur 2 sorties.  
Unterputz-Brausebatterie mit 2-Ausgänge Umstellung.  
Grupo ducha empotrar y desviador 2 salidas.  
Встроенные краны для душа и дивертер на 2 выхода

Articolo	Note	CROMO	BR	O
<b>3915W2/S</b>		594,00	726,00	858,00

**3907WS/S**

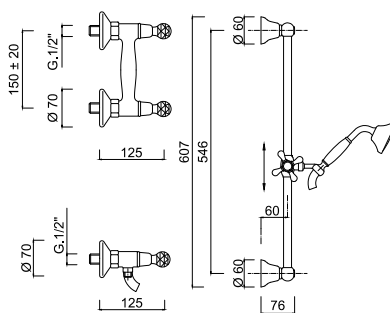

**Gruppo doccia esterno con saliscendi e doccia**

External shower mixer with sliding rail set.  
Mitigeur extérieur de douche avec barre coulissante et ensemble de douche.  
Aufputz-Brausebatterie mit Brausestange und Brauseset.  
Grupo ducha externo con conjunto ducha y barra deslizante  
Смеситель для душа внешнего монтажа с комплектом штанги для душа.

Articolo	Note	CROMO	BR	O
<b>3907WS/S</b>		590,00	747,00	911,00

**3907WC-S/S**

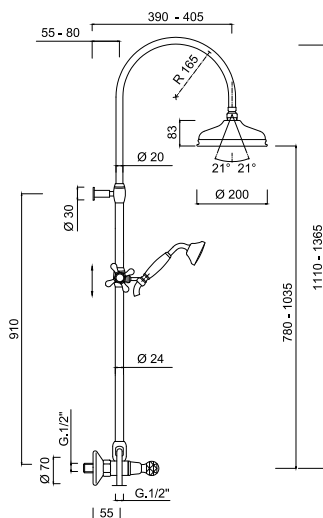

**Colonna doccia esterna, set doccia, soffione in ottone**

External shower column, shower kit, brass shower head.  
Colonne de douche extérieure, ensemble de douche, pomme de douche en laiton.  
Aufputz-Standbrause, Brauseset, Kopfbrause in Messing.  
Columna ducha externa, conjunto de ducha, rociador en latón.  
Душевая колонна внешнего монтажа, душевой набор, верхний душ из латуни.

Articolo	Note	CROMO	BR	O
<b>3907WC-S/S</b>		1.053,00	1.287,00	1.453,00

3907/S

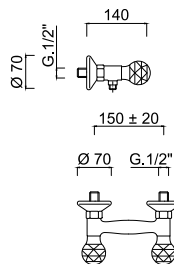

**Gruppo doccia esterno**

External shower mixer.  
Mitigeur extérieur de douche.  
Aufputz- Brausebatterie.  
Grupo ducha externo.  
Смеситель для душа внешнего монтажа

Articolo	Note	CROMO	BR	O
3907/S		355,00	422,00	489,00

3900/S

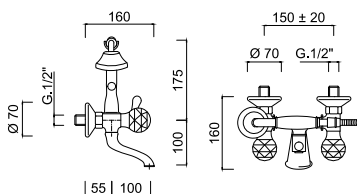

**Gruppo vasca esterno con doccia.**

External bathtub set with shower.  
Mélangeur bain-douche extérieur avec douchette.  
Wannenbatterie mit Schlauch-Handbrause nu verstellbarem.  
Grupo bañera externo con ducha.  
Внешний смеситель для ванны с душевой лейкой

Articolo	Note	CROMO	BR	O
3900/S		580,00	730,00	893,00

3965/S

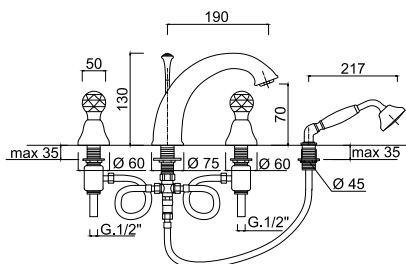

**Batteria bordo vasca 4 fori, bocca con deviatore.**

4-hole deck mounted set, spout with diverter.  
Mélangeur bain-douche sur gorge 4 trous, bec avec inverseur.  
4-Loch Wannenrandarmatur, Auslauf mit Umsteller.  
Grifo bañera de repisa 4 agujeros, caño con inversor.  
Комплект на 4 отверстия на край ванны, излив с дивертером

Articolo	Note	CROMO	BR	O
3965/S		778,00	979,00	1.188,00

3916/S

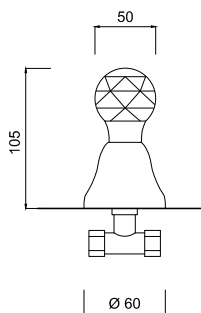

**Rubinetto incasso 1/2".**

1/2" built-in tap.  
Robinet à encaissement 1/2".  
UP-Ventil 1/2".  
Grifo para empotrar 1/2".  
Вентиль встроенный 1/2".

Articolo	Note	CROMO	BR	O
3916/S		175,00	209,00	242,00



**NOTE**

**Potete trovare altre soluzioni per la Doccia nell'area WELLNESS. p.374**

*For additional Shower options please go to WELLNESS section.*

*Pour plus de solutions pour la Douche visitez la section WELLNESS.*

*Für weitere Duschalternativen sehen Sie bitte in dem Kapitel WELLNESS nach.*

*Para más soluciones para Ducha visite la sección WELLNESS.*

*Другие решения для Душа вы найдете в разделе Wellness.*

**Per gli Accessori Bagno abbinati alla serie potete consultare la serie IBISCO CRYSTAL. p.454**

*For matching Bathroom Fittings please check IBISCO CRYSTAL. line.*

*Pour les Accessoires Salle de Bains coordonnés à la collection visitez la ligne IBISCO CRYSTAL.*

*Die zu der Serie passenden Bad-Accessoires finden Sie in dem Linie IBISCO CRYSTAL.*

*Para los Accesorios de Baño compatibles con la serie visite la línea IBISCO CRYSTAL.*

*Чтобы подобрать подходящие аксессуары для ванной комнаты, перейдите в Линия IBISCO CRYSTAL.*



# Harmony Harmony Crystal

Crystals from Swarovski®







**9505A**

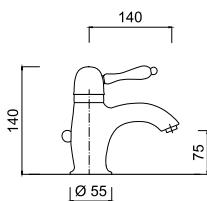

**Monocomando lavabo, scarico 1"1/4 (con flessibile).**  
Wash-basin single-lever mixer, 1"1/4 pop-up waste (with flexible).  
Mitigeur lavabo avec vidage 1"1/4 (avec flexible).  
Einhand-Waschtischbatterie mit Ablaufgarnitur 1"1/4 (mit flexiblen Anschlussschläuchen).  
Monomando lavabo tapón accionado por varilla 1"1/4 (con flexible).  
Однорычажный смеситель для раковины, донный клапан 1"1/4 (гибкая подводка).

Articolo	Note	CROMO	AR-BR	O
9505A		159,00	223,00	286,00
9505AL	L	165,00	229,00	292,00
9505ACE	CE	169,00	233,00	296,00
9505A/S	S	209,00	273,00	336,00
9605A	LB	163,00	227,00	290,00

**9541A**

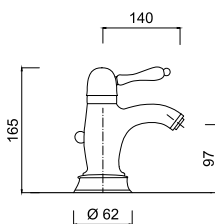

**Monocomando lavabo alto, scarico 1"1/4 (con flessibile).**  
High wash-basin mixer, 1"1/4 pop-up waste (with flexibles).  
Mitigeur lavabo haut, vidage 1"1/4 (avec flexibles).  
Hoher Einhebel-Waschtischmischer, Ablaufgarnitur 1"1/4 (inkl. Anschlussschläuche).  
Monomando lavabo alto, desagüe automatico 1"1/4 (con flex.).  
Высокий смеситель для раковины, донный клапан на 1"1/4 (с гибкими шлангами)

Articolo	Note	CROMO	AR-BR	O
9541A		200,00	280,00	360,00
9541AL	L	206,00	286,00	366,00
9541ACE	CE	210,00	290,00	370,00
9541A/S	S	250,00	330,00	410,00
9641A	LB	204,00	284,00	364,00

**9520**

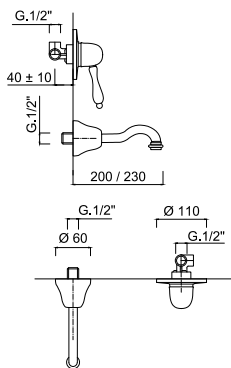
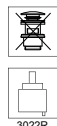

**Monocomando lavabo a muro, senza scarico**  
Wall-mounted wash-basin set, without pop-up waste.  
Mitigeur lavabo mural, sans vidage.  
Waschtisch- Einhebelmischer Wandmontage, ohne Ablaufgarnitur.  
Monomando Lavabo de pared, sin desagüe.  
Комплект настенного монтажа для раковины, без донного клапана

Articolo	Note	CROMO	AR-BR	O
9520		136,00	190,00	244,00
9520L	L	142,00	196,00	250,00
9520CE	CE	146,00	200,00	254,00
9520/S	S	186,00	240,00	294,00
9620	LB	140,00	194,00	248,00

**9541AH**

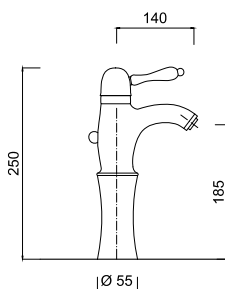

**Monocomando lavabo con prolunga, scarico 1"1/4 (con flessibile).**  
Wash-basin mixer with extension, 1"1/4 pop-up waste (with flexibles).  
Mitigeur lavabo rehaussé, vidage 1"1/4 (avec flexibles).  
Hoher Einhebel-Waschtischmischer, Ablaufgarnitur 1"1/4 (inkl. Anschlussschläuche).  
Monomando lavabo alto, desagüe automatico 1"1/4 (con flex.).  
Смеситель для раковины с удлинением, донный клапан на 1"1/4 (с гибкими шлангами)

Articolo	Note	CROMO	AR-BR	O
9541AH		238,00	333,00	428,00
9541AHL	L	244,00	339,00	434,00
9541AHCE	CE	248,00	343,00	438,00
9541AH/S	S	288,00	383,00	478,00
9641AH	LB	242,00	337,00	432,00

**9507A**

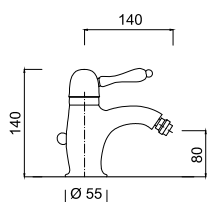

**Monocomando bidet, scarico 1"1/4 (con flessibile).**  
Bidet single-lever mixer, 1"1/4 pop-up waste (with flexible).  
Mitigeur bidet avec vidage 1"1/4 (avec flexible).  
Einhand-Bidetbatterie mit Ablaufgarnitur 1"1/4 (mit flexiblen Anschlussschläuchen).  
Monomando bidet, tapón accionado por varilla 1"1/4 (con flexible).  
Однорычажный смеситель для биде, донный клапан 1"1/4 (гибкая подводка).

Articolo	Note	CROMO	AR-BR	O
9507A		159,00	223,00	286,00
9507AL	L	165,00	229,00	292,00
9507ACE	CE	169,00	233,00	296,00
9507A/S	S	209,00	273,00	336,00
9607A	LB	163,00	227,00	290,00

9543A

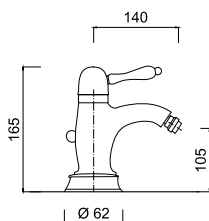

**Monocomando bidet alto, scarico 1"1/4 (con flessibile).**  
High bidet mixer, 1"1/4 pop-up waste (with flexibles).  
Mitigeur bidet haut, vidage 1"1/4 (avec flexibles).  
Hoher Einhebel-Bidetmischer, Ablaufgarnitur 1"1/4 (inkl. Anschlusschläuche).  
Monomando bidé alto, desagüe automático 1"1/4 (con flex.).  
Высокий смеситель для биде, донный клапан на 1"1/4 (с гибкими шлангами)

Articolo	Note	CROMO	AR-BR	O
9543A		200,00	280,00	360,00
9543AL	L	206,00	286,00	366,00
9543ACE	CE	210,00	290,00	370,00
9543A/S	S	250,00	330,00	410,00
9643A	LB	204,00	284,00	364,00

9515WB

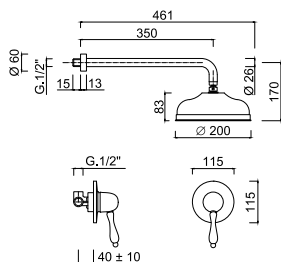

**Set doccia incasso monocomando, soffione ottone**  
Shower built-in single-lever mixer, brass shower head.  
Mitigeur pour douche à encaissement, pomme de douche en laiton.  
Unterputz-Duscheneinhebelmischer mit Kopfbrause, Kopfbrause in Messing.  
Monomando ducha para empotrar, rociador en latón.  
Однорычажный встроенный смеситель для душа, верхний душ из латуни

Articolo	Note	CROMO	AR-BR	O
9515WB		334,00	447,00	530,00
9515WBL	L	340,00	453,00	536,00
9515WBCE	CE	344,00	457,00	540,00
9515WB/S	S	384,00	497,00	580,00
9615WB	LB	338,00	451,00	534,00

9515WS

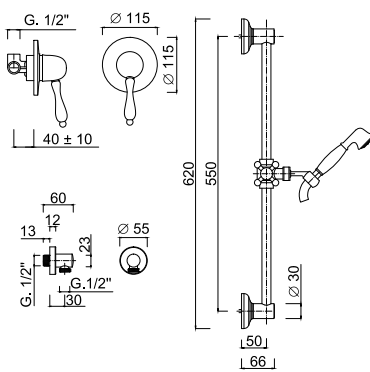

**Set doccia incasso monocomando, saliscendi, presa acqua.**  
Built-in shower mixer with sliding rail and water plug.  
Mitigeur douche à encastrer avec barre de douche et prise d'eau.  
UP-Einhebel-Brausemischer mit Brausestange, Brauseset und Wandanschlussbogen.  
Kit de ducha empotrado con barra deslizante y toma de agua.  
Встраиваемый смеситель для душа с регулируемой штангой и разъемом для подачи воды

Articolo	Note	CROMO	AR-BR	O
9515WS		275,00	415,00	574,00
9515WSL	L	281,00	421,00	580,00
9515WSCE	CE	285,00	425,00	584,00
9515WS/S	S	325,00	465,00	624,00
9615WS	LB	279,00	419,00	578,00

9515WC-S

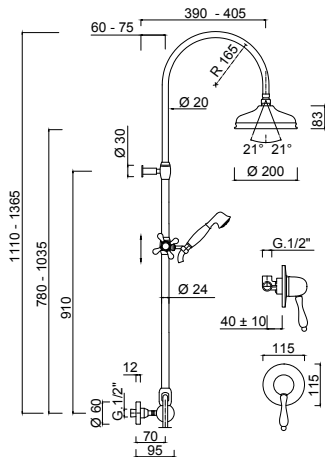

**Set doccia incasso monocomando, supporto presa/acqua, colonna doccia con soffione ottone.**  
Built-in shower mixer with holder/water plug, shower column and brass showerhead.  
Mitigeur douche à encastrer avec support/prise d'eau, colonne de douche et douche de tête en laiton.  
UP-Einhebel-Brausemischer, Brausehalter/Wandanschlussbogen, Duschsäule mit Kopfbrause aus Messing.  
Conjunto monomando ducha empotrado, soporte/toma de agua, rociador en latón.  
Встраиваемый смеситель для душа с держателем/разъемом для подачи воды, душевой колонной и верхним душем из латуни

Articolo	Note	CROMO	AR-BR	O
9515WC-S		844,00	1.076,00	1.221,00
9515WC-SL	L	850,00	1.082,00	1.227,00
9515WC-SCE	CE	875,00	1.107,00	1.252,00
9515WC-S/S	S	894,00	1.126,00	1.271,00
9615WC-S	LB	848,00	1.080,00	1.225,00

**9511KB**

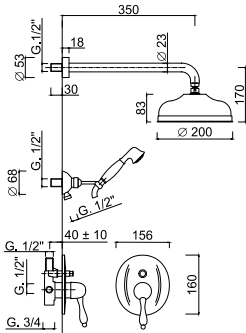
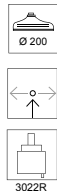

**Set doccia incasso monocomando con deviatore, soffione ottone, kit duplex incasso**

Shower built-in single-lever mixer with diverter, brass shower head, built-in duplex shower kit

Mitigeur pour douche à encaissement avec inverseur, pomme de douche en laiton, ensemble de douche duplex à encaissement

Unterputz- Duscheneinhebelmischer mit Umstellung, Brausekopf in Messing, Einbau- Brauseset Duplex

Monomando ducha para empotrar con desviador, rociador ducha en latón, conjunto ducha duplex para empotrar

Однорычажный встроенный смеситель для душа с дивертером, верхний душ из латуни, встроенный душевой набор "Duplex"

Articolo	Note	CROMO	AR-BR	O
9511KB		550,00	761,00	958,00
9511KBL	L	556,00	767,00	964,00
9511KBCE	CE	581,00	792,00	989,00
9511KB/S	S	600,00	811,00	1.008,00
9611KB	LB	554,00	765,00	962,00

**9515**

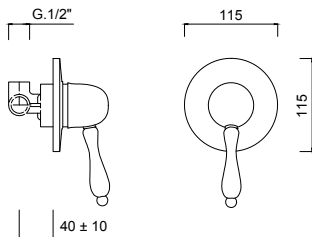

**Monocomando doccia incasso.**

Shower built-in single-lever mixer.

Mitigeur pour douche à encaissement.

Unterputz-Duscheneinhebelmischer.

Monomando ducha para empotrar.

Однорычажный встроенный смеситель для душа

Articolo	Note	CROMO	AR-BR	O
9515		91,00	121,00	151,00
9515L	L	97,00	127,00	157,00
9515CE	CE	101,00	131,00	161,00
9515/S	S	141,00	171,00	201,00
9615	LB	95,00	125,00	155,00

**9511**

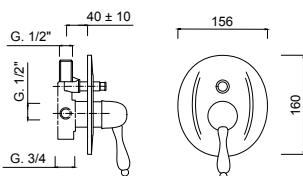
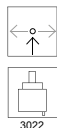

**Monocomando doccia incasso con deviatore**

Shower built-in single-lever mixer with diverter.

Mitigeur pour douche à encaissement avec inverseur.

Unterputz- Duscheneinhebelmischer mit Umstellung.

Monomando ducha para empotrar con desviador.

Однорычажный встроенный смеситель для душа с дивертером

Articolo	Note	CROMO	AR-BR	O
9511		193,00	272,00	338,00
9511L	L	199,00	278,00	344,00
9511CE	CE	203,00	282,00	348,00
9511/S	S	243,00	322,00	388,00
9611	LB	197,00	276,00	342,00

**9511-3**

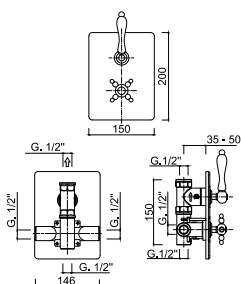
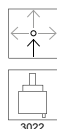

**Monocomando doccia incasso con deviatore 3 uscite**

Shower built-in single-lever mixer with 3 outlets diverter

Mitigeur pour douche à encaissement avec inverseur à 3 sorties

Unterputz- Duscheneinhebelmischer mit 3-Ausgänge Umstellung

Monomando ducha para empotrar con desviador a 3 salidas

Однорычажный встроенный смеситель для душа с дивертером на 3 выхода

Articolo	Note	CROMO	AR-BR	O
9511-3		278,00	403,00	500,00
9511-3L	L	290,00	415,00	512,00
9511-3CE	CE	298,00	423,00	520,00
9511-3/S	S	378,00	503,00	600,00
9611-3	LB	286,00	411,00	508,00

**9511-4**

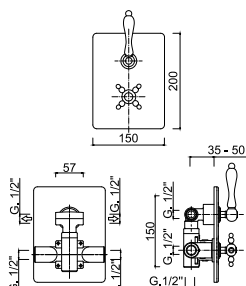
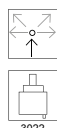

**Monocomando doccia incasso con deviatore 4 uscite**

Shower built-in single-lever mixer with 4 outlets diverter

Mitigeur pour douche à encaissement avec inverseur à 4 sorties

Unterputz- Duscheneinhebelmischer mit 4-Ausgänge Umstellung

Monomando ducha para empotrar con desviador a 4 salidas

Однорычажный встроенный смеситель для душа с дивертером на 4 выхода

Articolo	Note	CROMO	AR-BR	O
9511-4		295,00	427,00	531,00
9511-4L	L	307,00	439,00	543,00
9511-4CE	CE	315,00	447,00	551,00
9511-4/S	S	395,00	527,00	631,00
9611-4	LB	303,00	435,00	539,00



**8212-PR**

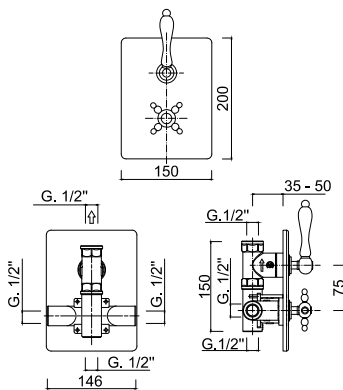

**Termostatico incasso 1/2", con rubinetto d'arresto 1/2".**  
Built-in thermostatic mixer 1/2", with built-in tap 1/2".  
Mitigeur thermostatique mural, 1/2", avec robinet mural 1/2".  
Eingebaute Einhebel Thermostatbatterie 1/2", mit Ventil 1/2".  
Mezclador termostatico a empotrar 1/2", con grifo 1/2".  
Встраиваемый термостат 1/2" со встраиваемым смесителем 1/4".

Articolo	Note	CROMO	AR-BR	O
8212-PR		528,00	686,00	792,00
8212-PRL	L	540,00	698,00	804,00
8212-PRCE	CE	548,00	706,00	812,00
8212-PR/S	S	628,00	786,00	892,00

**8213-PR**

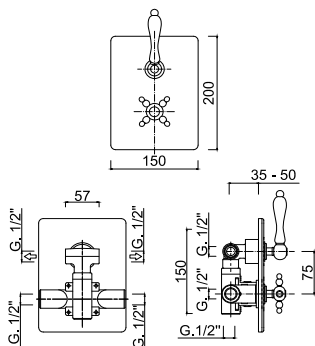

**Termostatico incasso 2 uscite**  
2 outlets built-in thermostatic mixer  
Mitigeur thermostatique mural à 2 sorties  
2-Ausgänge eingebaute Einhebel-Thermostatbatterie  
Mezclador termostatico a empotrar a 2 salidas.  
Встроенный термостатический смеситель на 2 выхода

Articolo	Note	CROMO	AR-BR	O
8213-PR		583,00	757,00	874,00
8213-PRL	L	595,00	769,00	886,00
8213-PRCE	CE	603,00	777,00	894,00
8213-PR/S	S	683,00	857,00	974,00

**8282-PR**

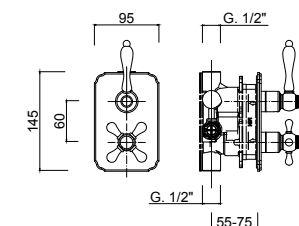
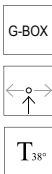

**Termostatico incasso 2 uscite, box incasso.**  
Built-in thermostatic mixer with 2 outlets, built-in box.  
Mitigeur thermostatique douche à encastrer avec 2 sorties, box d'encastrement.  
UP-Thermostat mit 2-Wege-Umstellung, inkl. Box.  
Termostática empotrada 2 salidas, box empotrado incluido.  
Встраиваемый термостатический смеситель с 2 выходами, встраиваемый бокс

Articolo	Note	CROMO	AR-BR	O
8282-PR		840,00	1.092,00	1.260,00
8282-PRL	L	846,00	1.098,00	1.266,00
8282-PRCE	CE	850,00	1.102,00	1.270,00
8282-PR/S	S	890,00	1.142,00	1.310,00

**8283-PR**

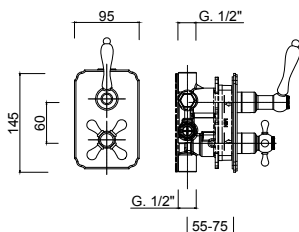
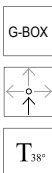

**Termostatico incasso 3 uscite, box incasso.**  
Built-in thermostatic mixer with 3 outlets, built-in box.  
Mitigeur thermostatique douche à encastrer avec 3 sorties, box d'encastrement.  
UP-Thermostat mit 3-Wege-Umstellung, inkl. Box.  
Termostática empotrada 3 salidas, box empotrado incluido.  
Встраиваемый термостатический смеситель с 3 выходами, встраиваемый бокс

Articolo	Note	CROMO	AR-BR	O
8283-PR		890,00	1.157,00	1.335,00
8283-PRL	L	896,00	1.163,00	1.341,00
8283-PRCE	CE	900,00	1.167,00	1.345,00
8283-PR/S	S	940,00	1.207,00	1.385,00

**1716**

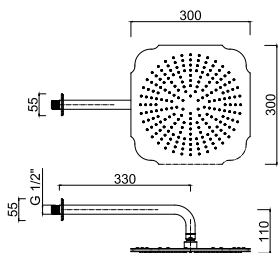

**Soffione con braccio doccia a parete.**  
Shower head with shower arm.  
Potte de douche avec bras de douche.  
Kopfbrause mit Wandarm.  
Rociador con brazo de ducha a pared.  
Верхний душ с держателем.

Articolo	Note	CROMO	AR-BR	O
1716		620,00	760,00	840,00



1714-20

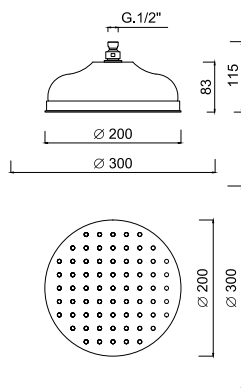

**Soffione doccia Ø 200.**

200 mm diameter shower head.

Pomme de douche Ø 200 mm.

Kopfbrause, Ø 200 mm.

Alcachofa Ø 200 mm.

Душевая лейка с защитой от известняка Ø 200.

Articolo	Note	CROMO	AR-BR	O
1714-20	mm 200	171,00	205,00	229,00
1714-30	mm 300	335,00	364,00	420,00

1751-35

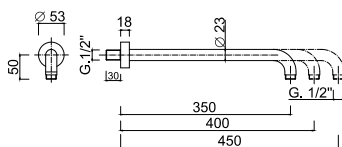

**Braccio doccia in ottone da mm 350.**

Brass shower arm, length mm 350.

Bras de douche, laiton chromé, longueur mm 350.

Wandarm, mm 350 Länge, verchromtes Messing.

Brazo ducha largo 350 mm, latón cromado.

Душевой кронштейн из латуни, длина 350 мм.

Articolo	Note	CROMO	AR-BR	O
1751-35	mm 350	78,00	121,00	150,00
1751-40	mm 400	83,00	•	•
1751-45	mm 450	98,00	•	•

1757

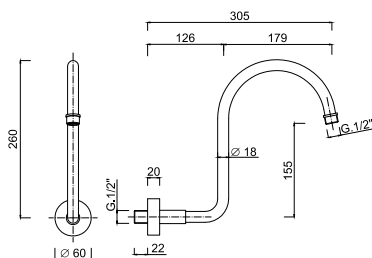

**Braccio doccia in ottone.**

Brass shower arm.

Bras de douche en laiton.

Wandarm aus Messing.

Brazo de ducha a pared en latón.

Держатель для душа из латуни

Articolo	Note	CROMO	AR-BR	O
1757		98,00	135,00	163,00

1762-10

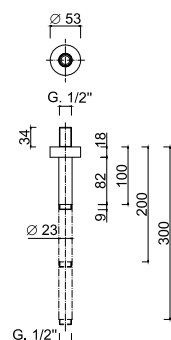

**Braccio doccia da soffitto mm.100.**

Ceiling shower arm mm 100.

Bras de douche vertical mm 100.

Brausearm für Deckenmontage mm 100.

Brazo de ducha a techo mm 100.

Держатель душа 100 мм, потолочный

Articolo	Note	CROMO	AR-BR	O
1762-10	mm 100	52,00	78,00	102,00
1762-20	mm 200	61,00	•	•
1762-30	mm 300	70,00	•	•

1552-N

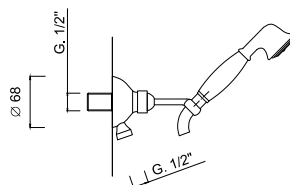

**Kit duplex incasso Lotus.**

Built-in duplex shower kit Lotus.

Ensemble de douche duplex à encaissement Lotus.

Einbaubrauseset Duplex Lotus.

Conjunto de ducha duplex para empotrar Lotus.

встроенный душевой набор "Duplex" Lotus.

Articolo	Note	CROMO	AR-BR	O
1552-N	NY	107,00	163,00	241,00
1552	OT	107,00	163,00	241,00
1552CE	MC	128,00	184,00	262,00

NY: Manopola Nylon / Nylon Hand-shower Handle - OT: Manopola Ottone / Brass Hand-shower Handle - MC: Manopola Ceramica / Ceramic Hand-shower Handle

### 9508WS

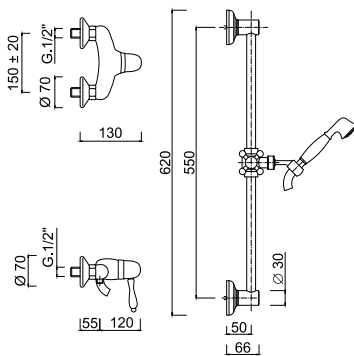

#### Monocomando doccia esterno con saliscendi e doccia.

Single-lever shower mixer with sliding rail set.  
Mitigeur douche mural avec barre coulissante et ensemble de douche.  
Aufputz-Einhebelbrausebatterie mit Brausestange und Brauseset.  
Monomando ducha exterior con conjunto ducha.  
Однорычажный смеситель для душа с комплектом штанги для душа.

Articolo	Note	CROMO	AR-BR	O
9508WS		343,00	513,00	692,00
9508WSL	L	349,00	519,00	698,00
9508WSCE	CE	374,00	544,00	723,00
9508WS/S	S	393,00	563,00	742,00
9608WS	LB	347,00	517,00	696,00

### 9508SWC-S

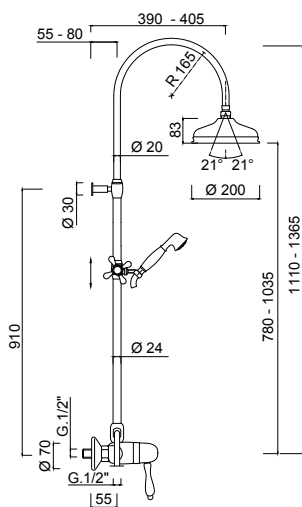

#### Colonna doccia esterna monocomando, set doccia, soffione in ottone

External single-lever shower mixer with shower column, shower kit, brass shower head.  
Mitigeur de douche avec colonne de douche, ensemble de douche, pomme de douche en laiton.  
Brausemischer mit Säulenbrause, Brauseset, Kopfbrause in Messing.  
Monomando con columna para ducha, conjunto de ducha, rociador en latón.  
Однорычажный смеситель для душа внешнего монтажа с душевой колонной, душевой набор, верхний душ из латуни.

Articolo	Note	CROMO	AR-BR	O
9508WC-S		862,00	1.109,00	1.263,00
9508WC-SL	L	868,00	1.115,00	1.269,00
9508WC-SCE	CE	893,00	1.140,00	1.294,00
9508WC-S/S	S	912,00	1.159,00	1.313,00
9608WC-S	LB	866,00	1.113,00	1.267,00

### 9508

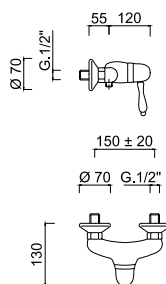

#### Monocomando doccia esterno

External single-lever shower mixer.  
Mitigeur pour douche externe.  
Aufputz-Einhebelbatterie.  
Monomando ducha externo.  
Однорычажный смеситель внешнего монтажа для душа.

Articolo	Note	CROMO	AR-BR	O
9508		158,00	227,00	284,00
9508L	L	164,00	233,00	290,00
9508CE	CE	168,00	237,00	294,00
9508/S	S	208,00	277,00	334,00
9608	LB	162,00	231,00	288,00

### 9508S

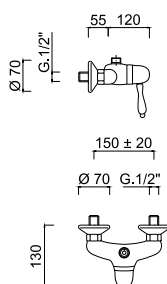

#### Monocomando doccia esterno (attacco superiore)

External single-lever shower mixer (upper connection).  
Mitigeur douche (connection supérieure).  
Aufputz-Brausemischer (oberer Anschluss).  
Monomando para ducha (ataco superior).  
Однорычажный смеситель для душа внешнего монтажа (подключение сверху)

Articolo	Note	CROMO	AR-BR	O
9508S		158,00	227,00	284,00
9508SL	L	164,00	233,00	290,00
9508SCE	CE	168,00	237,00	294,00
9508S/S	S	208,00	277,00	334,00
9608S	LB	162,00	231,00	288,00

9501

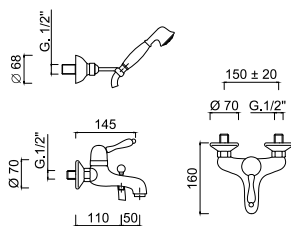

3022D

**Monocomando vasca esterno con set doccia duplex.**  
External bathtub single-lever mixer with duplex shower kit.  
Mitigeur bain/douche mural avec ensemble de douche duplex.  
Aufputz- Einhebelmischer mit Brauseset Duplex.  
Monomando bañera externo con conjunto de ducha duplex.  
Однорычажный смеситель внешнего монтажа для ванны с душевым набором "Duplex"

Articolo	Note	CROMO	AR-BR	O
9501		250,00	360,00	450,00
9501L	L	256,00	366,00	456,00
9501CE	CE	260,00	370,00	460,00
9501S	S	300,00	410,00	500,00
9601	LB	254,00	364,00	454,00

9565BD

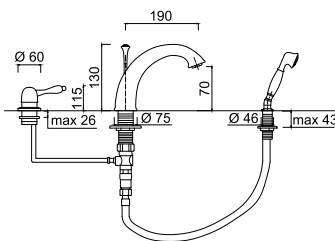

3022

**Monocomando bordo vasca 3 fori, bocca con deviatore**  
3-hole single-lever mixer for bath's border, spout with diverter.  
Mitigeur sur gorge à 3 trous, bec avec déviateur.  
3-Loch Wannemischer, Auslauf mit Umstellung.  
Monomando baño de repisa con 3 agujeros, caño con desviación.  
Однорычажный смеситель на борт ванны на 3 отверстия, излив с дивертером

Articolo	Note	CROMO	AR-BR	O
9565BD		475,00	684,00	855,00
9565BDL	L	481,00	690,00	861,00
9565BDCE	CE	485,00	694,00	865,00
9565BD/S	S	525,00	734,00	905,00
9665BD	LB	479,00	688,00	859,00

5009

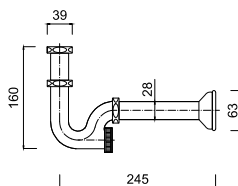

**Sifone per Lavabo 1"1/4.**  
Trap for basin 1"1/4.  
Siphon lavabo 1"1/4.  
Messing Rohrsifon 1"1/4 für Waschtisch  
Sifón para lavabo 1"1/4.  
Сифон для раковины 1"1/4

Articolo	Note	CROMO	AR-BR	O
5009		40,00	75,00	116,00

5009B

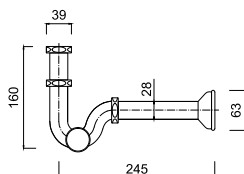

**Sifone per bidet 1"1/4.**  
Brass basin trap 1"1/4.  
Siphon bidet laiton 1"1/4.  
Messing Rohrsifon 1"1/4 für Bidet  
Sifón bidet en laiton 1"1/4.  
Сифон для умывальника из латуни 1"1/4.

Articolo	Note	CROMO	AR-BR	O
5009B		40,00	75,00	116,00

5011

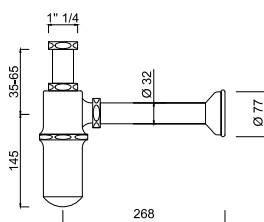

**Sifone 1" 1/4 a bottiglia.**  
Bottle trap for basin 1" 1/4.  
Siphon bouteille pour lavabo 1"1/4.  
Tassensifon 1" 1/4 für Waschtisch.  
Sifón botella para lavabo 1"1/4.  
Сифон бутылка 1" 1/4.

Articolo	Note	CROMO	AR-BR	O
5011		40,00	75,00	116,00

3063

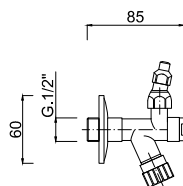

**Rubinetto con filtro con snodo.**  
Tap with filter with articulated joint.  
Robinet d'arrêt avec filtre et coude  
Eckventil mit Filter  
Llave de regulación con filtro  
Смеситель с фильтром и шарниром

Articolo	Note	CROMO	AR-BR	O	
3063		21,50	48,00	71,50	

3262

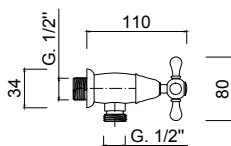

**Rubinetto sottolavabo.**  
Angle valve.  
Robinet d'arrêt sous lavabo.  
Eckventil.  
Llave de paso.  
Вентиль под раковину

Articolo	Note	CROMO	AR-BR	O	
3262		52,00	70,00	90,00	

1529

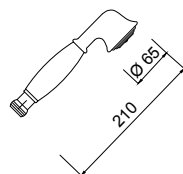

**Doccetta manopola ottone Lotus**  
Lotus hand-shower brass handle.  
Douchette avec poignée en laiton Lotus  
Lotus Handbrause mit Griff aus Messing  
Ducha de teléfono empuñadura latón Lotus  
Душевая лейка с ручкой из латуны Lotus

Articolo	Note	CROMO	AR-BR	O	
1529		45,00	59,00	76,00	
1529CE		66,00	80,00	97,00	

1530

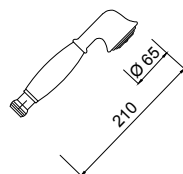

**Doccetta manopola nylon Lotus.**  
Lotus hand-shower nylon handle.  
Douchette avec poignée en nylon Lotus.  
Lotus Handbrause mit Griff aus Nylon.  
Ducha de teléfono empuñadura nylon Lotus.  
Душевая лейка с ручкой из нейлона Lotus.

Articolo	Note	CROMO	AR-BR	O	
1530		45,00	59,00	76,00	

1505-LO

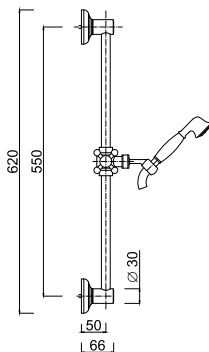

**Saliscendi con doccia Lotus**

Sliding rail with Lotus hand-shower.  
Barre de douche avec douchette Lotus.  
Brausestange mit Lotus-Handbrause.  
Barra deslizante con ducha de mano Lotus.  
регулируемая душевая штанга, ручной душ модель Lotus

Articolo	Note	CROMO	AR-BR	O
1505-LO		175,00	270,00	390,00

1510

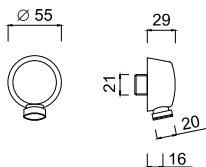

**Presca acqua 1/2"**

Water plug 1/2"  
Prise d'eau mural 1/2"  
Wandanschlußbogen 1/2" für Brauseanschluß  
Toma de agua 1/2"  
Крепление к стене для гибкого шланга

Articolo	Note	CROMO	AR-BR	O
1510		16,00	24,00	33,00



**LIBERTY**



HARMONY



RESINA BIANCA



CE - CERAMICA BIANCA



CE - CERAMICA NERA



S - SWAROVSKI LIGHT



S - SWAROVSKI NERO



L - WENGÉ



L - TEAK

**NOTE**

**Potete trovare altre soluzioni per la Doccia nell'area WELLNESS.**

For additional Shower options please go to WELLNESS section.  
Pour plus de solutions pour la Douche visitez la section WELLNESS.  
Für weitere Duschalternativen sehen Sie bitte in dem Kapitel WELLNESS nach.  
Para más soluciones para Ducha visite la sección WELLNESS.  
Другие решения для Душа вы найдёте в разделе Wellness.

p.374

**Per gli Accessori Bagno abbinati alla serie potete consultare la serie LILIUM - IBISCO CERMICA - IBISCO CRYSTAL.**

p.454 / 466

For matching Bathroom Fittings please check LILIUM - IBISCO CERMICA - IBISCO CRYSTAL. line.  
Pour les Accessoires Salle de Bains coordonnés à la collection visitez la ligne LILIUM - IBISCO CERMICA - IBISCO CRYSTAL.  
Die zu der Serie passenden Bad-Accessoires finden Sie in dem Linie LILIUM - IBISCO CERMICA - IBISCO CRYSTAL.  
Para los Accesorios de Baño compatibles con la serie visite la línea LILIUM - IBISCO CERMICA - IBISCO CRYSTAL.  
Чтобы подобрать подходящие аксессуары для ванной комнаты, перейдите в Линия LILIUM - IBISCO CERMICA - IBISCO CRYSTAL.



# Symphony

Crystals from Swarovski®









4305A

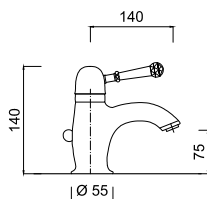

**Monocomando lavabo, scarico 1"1/4 (con flessibile).**  
Wash-basin single-lever mixer, 1"1/4 pop-up waste (with flexible).  
Mitigeur lavabo avec vidage 1"1/4 (avec flexible).  
Einhand-Waschtischbatterie mit Ablaufgarnitur 1"1/4 (mit flexiblen Anschlussschläuchen).  
Monomando lavabo tapón accionado por varilla 1"1/4 (con flexible).  
Однорычажный смеситель для раковины, донный клапан 1"1/4 (гибкая подводка).

Articolo	Note	CROMO	AR-BR	O
4305A		209,00	280,00	336,00

4341A

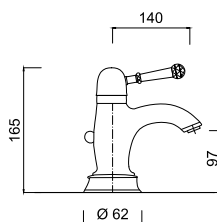

**Monocomando lavabo alto, scarico 1"1/4 (con flessibile).**  
High wash-basin mixer, 1"1/4 pop-up waste (with flexibles).  
Mitigeur lavabo haut, vidage 1"1/4 (avec flexibles).  
Hoher Einhebel-Waschtischmischer, Ablaufgarnitur 1"1/4 (inkl. Anschlussschläuche).  
Monomando lavabo alto, desagüe automatico 1"1/4 (con flex.).  
Высокий смеситель для раковины, донный клапан на 1"1/4 (с гибкими шлангами)

Articolo	Note	CROMO	AR-BR	O
4341A		250,00	340,00	410,00

4320

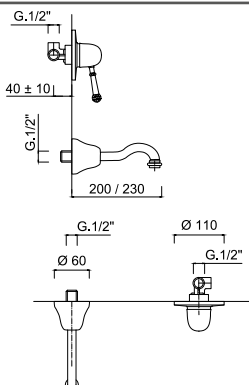

**Monocomando lavabo a muro, senza scarico**  
Wall-mounted wash-basin set, without pop-up waste.  
Mitigeur lavabo mural, sans vidage.  
Waschtisch- Einhebelmischer Wandmontage, ohne Ablaufgarnitur.  
Monomando Lavabo de pared, sin desagüe.  
Комплект настенного монтажа для раковины, без донного клапана

Articolo	Note	CROMO	AR-BR	O
4320		186,00	247,00	294,00

4341AH

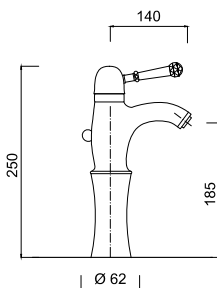

**Monocomando lavabo con prolunga, scarico 1"1/4 (con flessibile).**  
Wash-basin mixer with extension, 1"1/4 pop-up waste (with flexibles).  
Mitigeur lavabo rehaussé, vidage 1"1/4 (avec flexibles).  
Hoher Einhebel-Waschtischmischer, Ablaufgarnitur 1"1/4 (inkl. Anschlussschläuche).  
Monomando lavabo alto, desagüe automatico 1"1/4 (con flex.).  
Смеситель для раковины с удлинением, донный клапан на 1"1/4 (с гибкими шлангами)

Articolo	Note	CROMO	AR-BR	O
4341AH		288,00	395,00	478,00

4307A

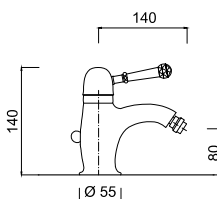

**Monocomando bidet, scarico 1"1/4 (con flessibile).**  
Bidet single-lever mixer, 1"1/4 pop-up waste (with flexible).  
Mitigeur bidet avec vidage 1"1/4 (avec flexible).  
Einhand-Bidetbatterie mit Ablaufgarnitur 1"1/4 (mit flexiblen Anschlussschläuchen).  
Monomando bidet, tapón accionado por varilla 1"1/4 (con flexible).  
Однорычажный смеситель для биде, донный клапан 1"1/4 (гибкая подводка).

Articolo	Note	CROMO	AR-BR	O
4307A		209,00	280,00	336,00

**4343A**

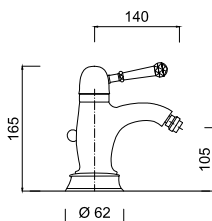

**Monocomando bidet alto, scarico 1"1/4 (con flessibile).**  
High bidet mixer, 1"1/4 pop-up waste (with flexibles).  
Mitigeur bidet haut, vidage 1"1/4 (avec flexibles).  
Hoher Einhebel-Bidetmischer, Ablaufgarnitur 1"1/4 (inkl. Anschlussschläuche).  
Monomando bidé alto, desagüe automático 1"1/4 (con flex.).  
Высокий смеситель для биде, донный клапан на 1"1/4 (с гибкими шлангами)

Articolo	Note	CROMO	AR-BR	O
<b>4343A</b>		250,00	340,00	410,00

**4315WB**

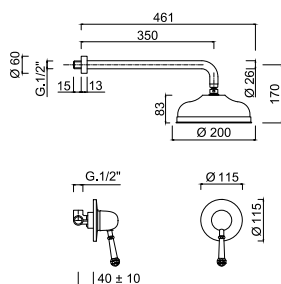

**Set doccia incasso monocomando, soffione ottone**  
Shower built-in single-lever mixer, brass shower head.  
Mitigeur pour douche à encaissement, pomme de douche en laiton.  
Unterputz-Duscheneinhebelmischer mit Kopfbrause, Kopfbrause in Messing.  
Monomando ducha para empotrar, rociador en latón.  
Однорычажный встроенный смеситель для душа, верхний душ из латуни

Articolo	Note	CROMO	AR-BR	O
<b>4315WB</b>		384,00	497,00	580,00

**4315WS**

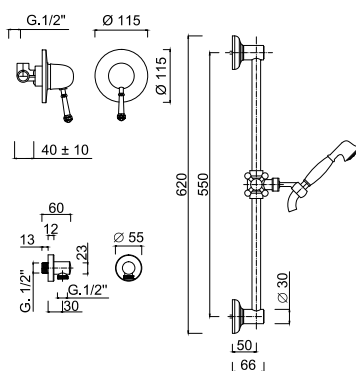

**Set doccia incasso monocomando, saliscendi, presa acqua.**  
Built-in shower mixer with sliding rail and water plug.  
Mitigeur douche à encastrer avec barre de douche et prise d'eau.  
UP-Einhebel-Brausemischer mit Brausestange, Brauseset und Wandanschlussbogen.  
Kit de ducha empotrado con barra deslizante y toma de agua.  
Встраиваемый смеситель для душа с регулируемой штангой и разъемом для подачи воды

Articolo	Note	CROMO	AR-BR	O
<b>4315WS</b>		325,00	465,00	624,00

**4315WC-S**

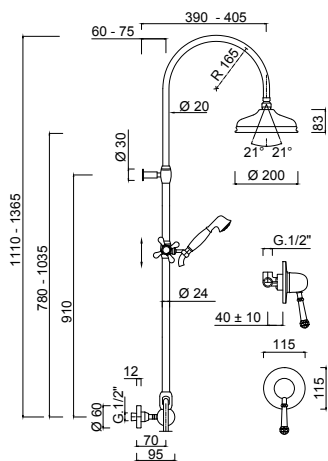

**Set doccia incasso monocomando, supporto presa/acqua, colonna doccia con soffione ottone.**  
Built-in shower mixer with holder/water plug, shower column and brass showerhead.  
Mitigeur douche à encastrer avec support/prise d'eau, colonne de douche et douche de tête en laiton.  
UP-Einhebel-Brausemischer, Brausehalter/Wandanschlussbogen, Duschsäule mit Kopfbrause aus Messing.  
Conjunto monomando ducha empotrado, soporte/toma de agua, rociador en latón.  
Встраиваемый смеситель для душа с держателем/разъемом для подачи воды, душевой колонной и верхним душем из латуни

Articolo	Note	CROMO	AR-BR	O
<b>4315WC-S</b>		894,00	1.126,00	1.271,00

**4311KB**

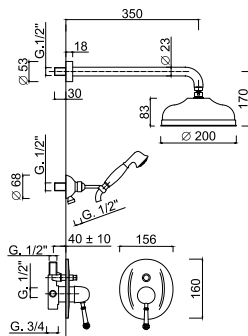
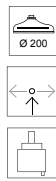

**Set doccia incasso monocomando con deviatore, soffione ottone, kit duplex incasso**

Shower built-in single-lever mixer with diverter, brass shower head, built-in duplex shower kit

Mitigeur pour douche à encaissement avec inverseur, pomme de douche en laiton, ensemble de douche duplex à encaissement

Unterputz- Duscheneinhebelmischer mit Umstellung, Brausekopf in Messing, Einbau- Brauseset Duplex

Monomando ducha para empotrar con desviador, rociador ducha en latón, conjunto ducha duplex para empotrar

Однорычажный встроенный смеситель для душа с дивертером, верхний душ из латуни, встроенный душевой набор "Duplex"

Articolo	Note	CROMO	AR-BR	O
4311KB		600,00	811,00	1.008,00

**4315**

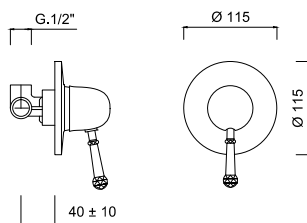

**Monocomando doccia incasso.**

Shower built-in single-lever mixer.

Mitigeur pour douche à encaissement.

Unterputz-Duscheneinhebelmischer.

Monomando ducha para empotrar.

Однорычажный встроенный смеситель для душа

Articolo	Note	CROMO	AR-BR	O
4315		141,00	171,00	201,00

**4311**

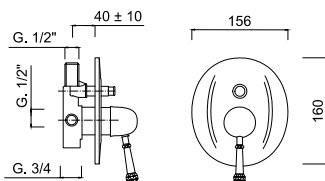
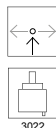

**Monocomando doccia incasso con deviatore**

Shower built-in single-lever mixer with diverter.

Mitigeur pour douche à encaissement avec inverseur.

Unterputz- Duscheneinhebelmischer mit Umstellung.

Monomando ducha para empotrar con desviador.

Однорычажный встроенный смеситель для душа с дивертером

Articolo	Note	CROMO	AR-BR	O
4311		243,00	322,00	388,00

**4311-3**

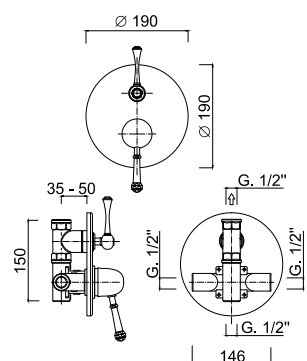
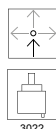

**Monocomando doccia incasso con deviatore 3 uscite**

Shower built-in single-lever mixer with 3 outlets diverter

Mitigeur pour douche à encaissement avec inverseur à 3 sorties

Unterputz- Duscheneinhebelmischer mit 3-Ausgänge Umstellung

Monomando ducha para empotrar con desviador a 3 salidas

Однорычажный встроенный смеситель для душа с дивертером на 3 выхода

Articolo	Note	CROMO	AR-BR	O
4311-3		328,00	453,00	550,00

**4311-4**

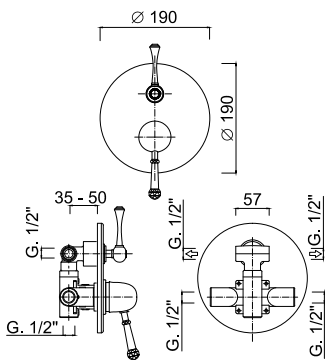
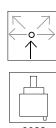

**Monocomando doccia incasso con deviatore 4 uscite**

Shower built-in single-lever mixer with 4 outlets diverter

Mitigeur pour douche à encaissement avec inverseur à 4 sorties

Unterputz- Duscheneinhebelmischer mit 4-Ausgänge Umstellung

Monomando ducha para empotrar con desviador a 4 salidas

Однорычажный встроенный смеситель для душа с дивертером на 4 выхода

Articolo	Note	CROMO	AR-BR	O
4311-4		345,00	477,00	581,00

1716

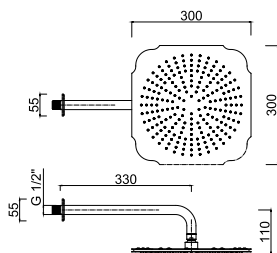

**Soffione con braccio doccia a parete.**  
Shower head with shower arm.  
Pomme de douche avec bras de douche.  
Kopfbrause mit Wandarm.  
Rociador con brazo de ducha a pared.  
Верхний душ с держателем.

Articolo	Note	CROMO	AR-BR	O
1716		620,00	760,00	840,00

1714-20

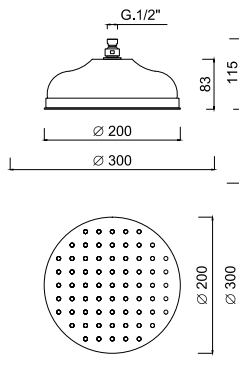

**Soffione doccia Ø 200.**  
200 mm diameter shower head.  
Pomme de douche Ø 200 mm.  
Kopfbrause, Ø 200 mm.  
Alcachofa Ø 200 mm.  
Душевая лейка с защитой от известняка Ø 200.

Articolo	Note	CROMO	AR-BR	O
1714-20	mm 200	171,00	205,00	229,00
1714-30	mm 300	335,00	364,00	420,00

1751-35

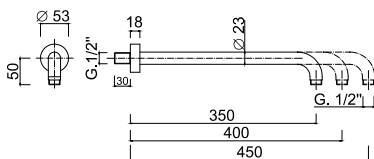

**Braccio doccia in ottone da mm 350.**  
Brass shower arm, length mm 350.  
Bras de douche, laiton chromé, longueur mm 350.  
Wandarm, mm 350 Länge, verchromtes Messing.  
Brazo ducha largo 350 mm, latón cromado.  
Душевой кронштейн из латуни, длина 350 мм.

Articolo	Note	CROMO	AR-BR	O
1751-35	mm 350	78,00	121,00	150,00
1751-40	mm 400	83,00	•	•
1751-45	mm 450	98,00	•	•

1757

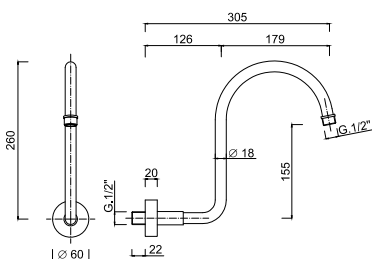

**Braccio doccia in ottone.**  
Brass shower arm.  
Bras de douche en laiton.  
Wandarm aus Messing.  
Brazo de ducha a pared en latón.  
Держатель для душа из латуни

Articolo	Note	CROMO	AR-BR	O
1757		98,00	135,00	163,00

1762-10

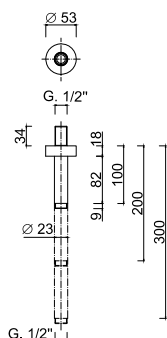

**Braccio doccia da soffitto mm.100.**  
Ceiling shower arm mm 100.  
Bras de douche vertical mm 100.  
Brausearm für Deckenmontage mm 100.  
Brazo de ducha a techo mm 100.  
Держатель душа 100 мм, потолочный

Articolo	Note	CROMO	AR-BR	O
1762-10	mm 100	52,00	78,00	102,00
1762-20	mm 200	61,00	•	•
1762-30	mm 300	70,00	•	•

1552

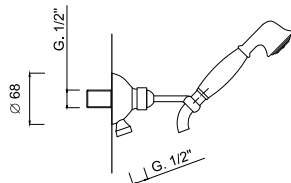

**Kit duplex incasso Lotus.**

Built-in duplex shower kit Lotus.  
Ensemble de douche duplex à encaissement Lotus.  
Einbaubrauseset Duplex Lotus.  
Conjunto de ducha duplex para empotrar Lotus.  
встроенный душевой набор "Duplex" Lotus.

Articolo	Note	CROMO	AR-BR	O
1552		107,00	163,00	241,00

4308WS

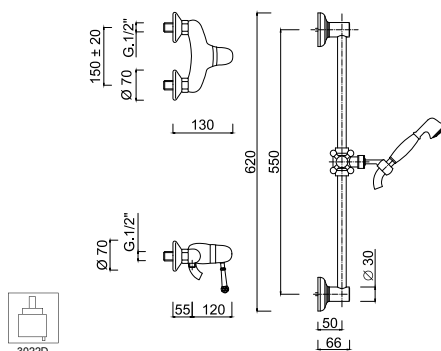

**Monocomando doccia esterno con saliscendi e doccia.**

Single-lever shower mixer with sliding rail set.  
Mitigeur douche mural avec barre coulissante et ensemble de douche.  
Aufputz-Einhebelbrausebatterie mit Brausestange und Brauseset.  
Monomando ducha exterior con conjunto ducha.  
Однорычажный смеситель для душа с комплектом штанги для душа.

Articolo	Note	CROMO	AR-BR	O
4308WS		393,00	563,00	742,00

4308SWC-S

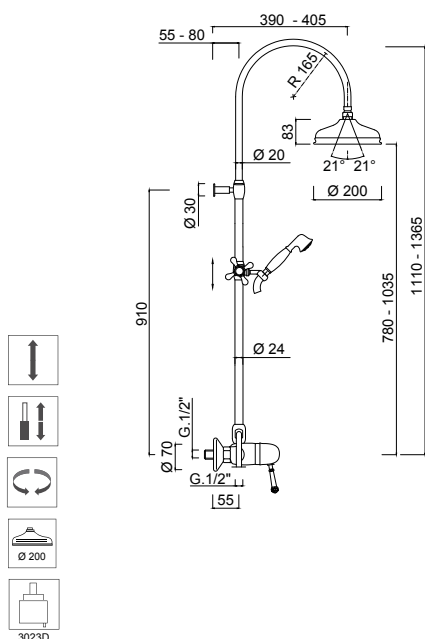

**Colonna doccia esterna monocomando, set doccia, soffione in ottone**

External single-lever shower mixer with shower column, shower kit, brass shower head.  
Mitigeur de douche avec colonne de douche, ensemble de douche, pomme de douche en laiton.  
Brausemischer mit Säulenbrause, Brauseset, Kopfbrause in Messing.  
Monomando ducha con columna para ducha, conjunto de ducha, rociador en latón.  
Однорычажный смеситель для душа внешнего монтажа с душевой колонной, душевой набор, верхний душ из латуни.

Articolo	Note	CROMO	AR-BR	O
4308SWC-S		918,00	1.159,00	1.313,00

4308

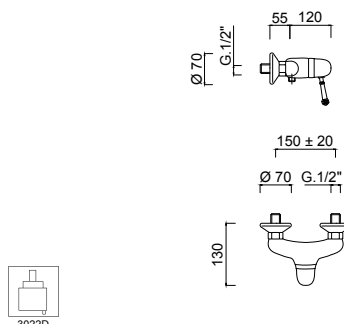

**Monocomando doccia esterno**

External single-lever shower mixer.  
Mitigeur pour douche externe.  
Aufputz-Einhebelbatterie.  
Monomando ducha externo.  
Однорычажный смеситель внешнего монтажа для душа.

Articolo	Note	CROMO	AR-BR	O
4308		208,00	277,00	334,00





4308S

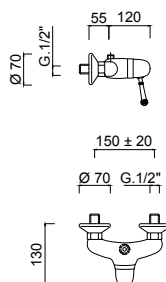

**Monocomando doccia esterno (attacco superiore)**

External single-lever shower mixer (upper connection).

Mitigeur douche (connection supérieure).

Aufputz- Brausemischer (oberer Anschluss).

Monomando para ducha (ataco superior).

Однорычажный смеситель для душа внешнего монтажа (подключение сверху)

Articolo	Note	CROMO	AR-BR	O
4308S		208,00	277,00	334,00

4301

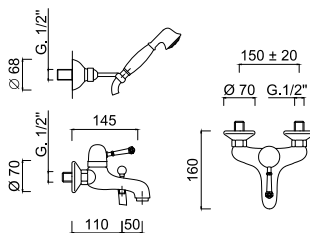

**Monocomando vasca esterno con set doccia duplex.**

External bathtub single-lever mixer with duplex shower kit.

Mitigeur bain/douche mural avec ensemble de douche duplex.

Aufputz- Einhebelmischer mit Brauseset Duplex.

Monomando bañera externo con conjunto de ducha duplex.

Однорычажный смеситель внешнего монтажа для ванны с душевым набором "Duplex"

Articolo	Note	CROMO	AR-BR	O
4301		300,00	410,00	500,00

4365BD

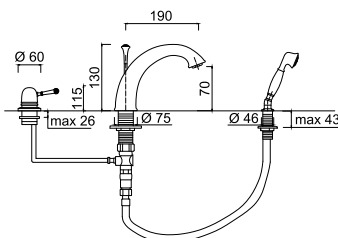

**Monocomando bordo vasca 3 fori, bocca con deviatore**

3-hole single-lever mixer for bath's border, spout with diverter.

Mitigeur sur gorge à 3 trous, bec avec déviateur.

3-Loch Wannemischer, Auslauf mit Umstellung.

Monomando baño de repisa con 3 agujeros, caño con desviación.

Однорычажный смеситель на борт ванны на 3 отверстия, излив с дивертером

Articolo	Note	CROMO	AR-BR	O
4365BD		525,00	734,00	905,00

5009

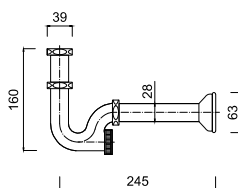

**Sifone per Lavabo 1"1/4.**

Trap for basin 1"1/4.

Siphon lavabo 1"1/4.

Messing Rohrsiphon 1"1/4 für Waschtisch

Sifón para lavabo 1"1/4.

Сифон для раковины 1"1/4

Articolo	Note	CROMO	AR-BR	O
5009		40,00	75,00	116,00

5009B

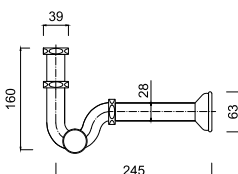

**Sifone per bidet 1"1/4.**

Brass basin trap 1"1/4.

Siphon bidet laiton 1"1/4.

Messing Rohrsiphon 1"1/4 für Bidet

Sifón bidet en laiton 1"1/4.

Сифон для умывальника из латуни 1"1/4.

Articolo	Note	CROMO	AR-BR	O
5009B		40,00	75,00	116,00

5011

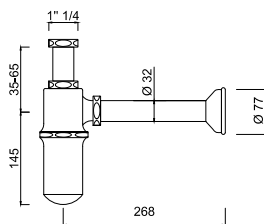

**Sifone 1" 1/4 a bottiglia.**  
*Bottle trap for basin 1" 1/4.*  
*Siphon bouteille pour lavabo 1"1/4.*  
*Tassensifon 1" 1/4 für Waschtisch.*  
*Sifón botella para lavabo 1"1/4.*  
*Сифон бутылка 1" 1/4.*

Articolo	Note	CROMO	AR-BR	O
5011		40,00	75,00	116,00

3063

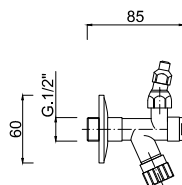

**Rubinetto con filtro con snodo.**  
*Tap with filter with articulated joint.*  
*Robinet d'arrêt avec filtre et coude*  
*Eckventil mit Filter*  
*Llave de regulaciòn con filtro*  
*Смеситель с фильтром и шарниром*

Articolo	Note	CROMO	AR-BR	O
3063		21,50	48,00	71,50

3262

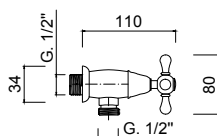

**Rubinetto sottolavabo.**  
*Angle valve.*  
*Robinet d'arrêt sous lavabo.*  
*Eckventil.*  
*Llave de paso.*  
*Вентиль под раковину*

Articolo	Note	CROMO	AR-BR	O
3262		52,00	70,00	90,00

1529

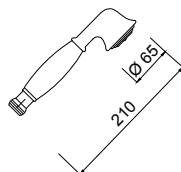

**Doccetta manopola ottone Lotus.**  
*Lotus hand-shower brass handle.*  
*Douchette avec poignée en laiton Lotus.*  
*Lotus Handbrause mit Griff aus Messing.*  
*Ducha de teléfono empuñadura latón Lotus.*  
*Душевая лейка с ручкой из латуни Lotus.*

Articolo	Note	CROMO	AR-BR	O
1529		45,00	59,00	76,00

1505-LO

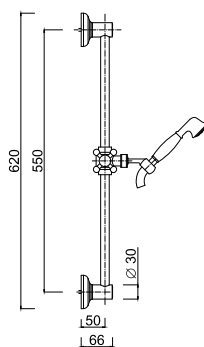

**Saliscendi con doccia Lotus**  
*Sliding rail with Lotus hand-shower.*  
*Barre de douche avec douchette Lotus.*  
*Brausestange mit Lotus-Handbrause.*  
*Barra deslizable con ducha de mano Lotus.*  
*регулируемая душевая штанга, ручной душ модель Lotus*

Articolo	Note	CROMO	AR-BR	O
1505-LO		175,00	270,00	390,00

1510

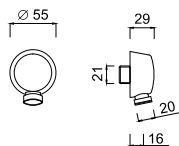

**Presca acqua 1/2"**  
Water plug 1/2"  
Prise d'eau mural 1/2"  
Wandanschlußbogen 1/2" für Brauseanschluß  
Toma de agua 1/2"  
Крепление к стене для гибкого шланга

Articolo	Note	CROMO	AR-BR	O	
1510		16,00	24,00	33,00	

**NOTE**

**Potete trovare altre soluzioni per la Doccia nell'area WELLNESS.** p.374  
For additional Shower options please go to WELLNESS section.  
Pour plus de solutions pour la Douche visitez la section WELLNESS.  
Für weitere Duschalternativen sehen Sie bitte in dem Kapitel WELLNESS nach.  
Para más soluciones para Ducha visite la sección WELLNESS.  
Другие решения для Душа вы найдете в разделе Wellness.

**Per gli Accessori Bagno abbinati alla serie potete consultare la serie IBISCO CRYSTAL.** p.454  
For matching Bathroom Fittings please check IBISCO CRYSTAL. line.  
Pour les Accessoires Salle de Bains coordonnés à la collection visitez la ligne IBISCO CRYSTAL.  
Die zu der Serie passenden Bad-Accessoires finden Sie in dem Linie IBISCO CRYSTAL.  
Para los Accesorios de Baño compatibles con la serie visite la línea IBISCO CRYSTAL.  
Чтобы подобрать подходящие аксессуары для ванной комнаты, перейдите в Линия IBISCO CRYSTAL.



A perfume bottle with a clear glass body and a faceted crystal stopper sits on a textured straw mat. The bottle is partially filled with a golden-yellow liquid. The background is a soft, out-of-focus brown. In the foreground, the edge of a white plate is visible. The overall aesthetic is elegant and natural.

# Hermitage Hermitage Crystal

Crystals from Swarovski®









**4433A**

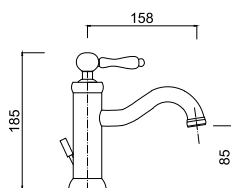

**Monocomando lavabo, scarico 1"1/4 (con flessibile).**  
Wash-basin single-lever mixer, 1"1/4 pop-up waste (with flexible).  
Mitigeur lavabo avec vidage 1"1/4 (avec flexible).  
Einhand-Waschtischbatterie mit Ablaufgarnitur 1"1/4 (mit flexiblen Anschlussschläuchen).  
Monomando lavabo tapón accionado por varilla 1"1/4 (con flexible).  
Однорычажный смеситель для раковины, донный клапан 1"1/4 (гибкая подводка).

Articolo	Note	CROMO	BR	O
4433A		322,00	466,00	579,00
4433AL	L	328,00	472,00	585,00
4433ACE	CE	332,00	476,00	589,00
4433A/S	S	372,00	516,00	629,00

**4437/SC**

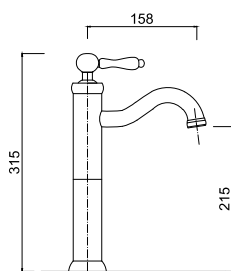

**Monocomando lavabo con prolunga, senza scarico (con flessibile).**  
Wash-basin mixer with extension, without pop-up waste (with flexibles).  
Mitigeur lavabo rehaussé, sans vidage (avec flexibles).  
Hoher Einhebel-Waschtischmischer, ohne Ablaufgarnitur (inkl. Anschlussschläuche).  
Monomando lavabo alto, sin desagüe automático (con flex.).  
Смеситель для раковины с удлинением, без донного клапана (с гибкими шлангами)

Articolo	Note	CROMO	BR	O
4437/SC		355,00	514,00	639,00
4437/SCL	L	361,00	520,00	645,00
4437/SCCE	CE	365,00	524,00	649,00
4437/SC/S	S	405,00	564,00	689,00

**4435A**

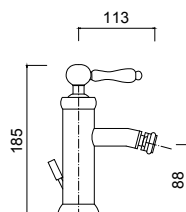

**Monocomando bidet, scarico 1"1/4 (con flessibile).**  
Bidet single-lever mixer, 1"1/4 pop-up waste (with flexible).  
Mélangeur bidet avec vidage 1"1/4 (avec flexible).  
Einhand-Bidetbatterie mit Ablaufgarnitur 1"1/4 (mit flexiblen Anschlussschläuchen).  
Monomando bidet, tapón accionado por varilla 1"1/4 (con flexible).  
Однорычажный смеситель для биде, донный клапан 1"1/4 (гибкая подводка).

Articolo	Note	CROMO	BR	O
4435A		322,00	466,00	579,00
4435AL	L	328,00	472,00	585,00
4435ACE	CE	332,00	476,00	589,00
4435A/S	S	372,00	516,00	629,00

**4415**

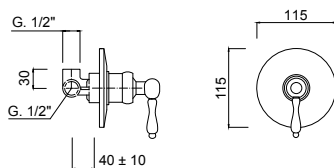

**Monocomando doccia incasso.**  
Shower built-in single-lever mixer.  
Mitigeur pour douche à encaissement.  
Unterputz-Duscheneinhebelmischer.  
Monomando ducha para empotrar.  
Однорычажный встроенный смеситель для душа

Articolo	Note	CROMO	BR	O
4415		132,00	191,00	237,00
4415L	L	138,00	197,00	243,00
4415CE	CE	142,00	201,00	247,00
4415/S	S	182,00	241,00	287,00

**4413**

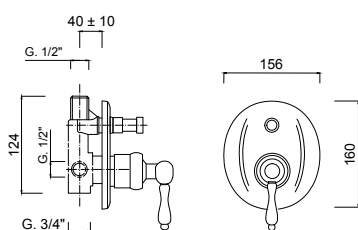
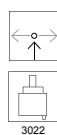

**Monocomando doccia incasso con deviatore**  
Shower built-in single-lever mixer with diverter.  
Mitigeur pour douche à encaissement avec inverseur.  
Unterputz-Duscheneinhebelmischer mit Umstellung.  
Monomando ducha para empotrar con desviador.  
Однорычажный встроенный смеситель для душа с дивертером

Articolo	Note	CROMO	BR	O
4413		231,00	335,00	416,00
4413L	L	237,00	341,00	422,00
4413CE	CE	241,00	345,00	426,00
4413/S	S	281,00	385,00	466,00

4408

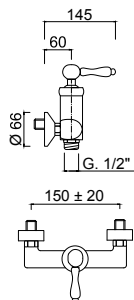

**Monocomando doccia esterno**

External single-lever shower mixer.

Mitigeur pour douche externe.

Aufputz-Einhebelbatterie.

Monomando ducha externo.

Однорычажный смеситель внешнего монтажа для душа.

Articolo	Note	CROMO	BR	O
4408		256,00	371,00	460,00
4408L	L	262,00	377,00	466,00
4408CE	CE	266,00	381,00	470,00
4408/S	S	306,00	421,00	510,00

4401

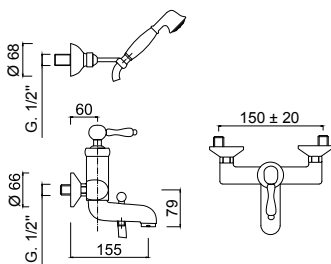

**Monocomando vasca esterno con set doccia duplex.**

External bathtub single-lever mixer with duplex shower kit.

Mitigeur bain/douche mural avec ensemble de douche duplex.

Aufputz-Einhebelmischer mit Brauseset Duplex.

Monomando bañera externo con conjunto de ducha duplex.

Однорычажный смеситель внешнего монтажа для ванны с душевым набором "Duplex".

Articolo	Note	CROMO	BR	O
4401		418,00	606,00	752,00
4401L	L	424,00	612,00	758,00
4401CE	CE	428,00	616,00	762,00
4401/S	S	468,00	656,00	802,00

Vasca - Bath



HERMITAGE



RESINA BIANCA



CE - CERAMICA BIANCA



CE - CERAMICA NERA



S - SWAROVSKI LIGHT



S - SWAROVSKI NERO



L - WENGÉ



L - TEAK

**NOTE**

**Potete trovare altre soluzioni per la Doccia nell'area WELLNESS.**

For additional Shower options please go to WELLNESS section.

Pour plus de solutions pour la Douche visitez la section WELLNESS.

Für weitere Duschalternativen sehen Sie bitte in dem Kapitel WELLNESS nach.

Para más soluciones para Ducha visite la sección WELLNESS.

Другие решения для Душа вы найдете в разделе Wellness.

p.374

**Per gli Accessori Bagno abbinati alla serie potete consultare la serie LILIUM - IBISCO CERMICA - IBISCO CRYSTAL.**

p.454 / 466

For matching Bathroom Fittings please check LILIUM - IBISCO CERMICA - IBISCO CRYSTAL. line.

Pour les Accessoires Salle de Bains coordonnés à la collection visitez la ligne LILIUM - IBISCO CERMICA - IBISCO CRYSTAL.

Die zu der Serie passenden Bad-Accessoires finden Sie in dem Linie LILIUM - IBISCO CERMICA - IBISCO CRYSTAL.

Para los Accesorios de Baño compatibles con la serie visite la línea LILIUM - IBISCO CERMICA - IBISCO CRYSTAL.

Чтобы подобрать подходящие аксессуары для ванной комнаты, перейдите в Линия LILIUM - IBISCO CERMICA - IBISCO CRYSTAL.



Kensington



3706A

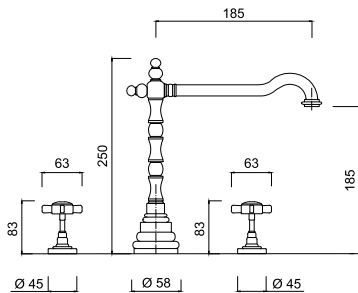

**Batteria lavabo 3 fori, bocca girevole, scarico 1"1/4**  
3-hole wash-basin set, swivel spout, 1"1/4 pop-up waste.  
Mélangeur lavabo à trois trous, bec mobile, vidage automatique 1"1/4.  
Waschtisch-Dreilochbatterie, Rohrauslauf, Ablaufgarnitur 1"1/4.  
Batería lavabo con 3 agujeros, caño giratorio, tapón accionado por varilla 1"1/4.  
Комплект для раковины на 3 отверстия, поворотный излив, донный клапан 1"1/4

Articolo	Note	CROMO	BR	O
3706A		315,00	456,00	567,00

3712A

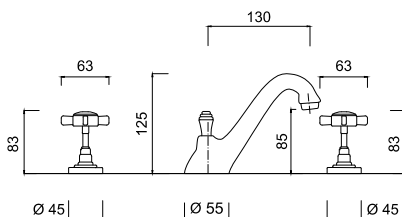

**Batteria lavabo 3 fori, scarico 1"1/4**  
3-hole wash-basin set, 1"1/4 pop-up waste.  
Mélangeur lavabo à trois trous, vidage automatique 1"1/4.  
Waschtisch-Dreilochbatterie, Ablaufgarnitur 1"1/4.  
Batería lavabo con 3 agujeros, tapón accionado por varilla 1"1/4.  
Комплект для раковины на 3 отверстия, донный клапан 1"1/4

Articolo	Note	CROMO	BR	O
3712A		275,00	398,00	495,00

S3756A

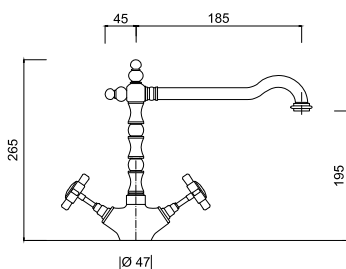

**Monoforo lavabo, bocca girevole, scarico 1"1/4 (con flessibile)**  
Wash-basin unit, swivel spout, 1"1/4 pop-up waste (with flexible).  
Mélangeur monotrou lavabo, bec mobile, vidage automatique 1"1/4 (avec flex.).  
Waschtisch-Einlochbatterie, Rohrauslauf, Ablaufgarnitur 1"1/4 (mit flexiblen Anschlussschläuchen).  
Monobloque lavabo, caño giratorio, tapón accionado por varilla 1"1/4 (con flexible).  
Смеситель для раковины, поворотный излив, донный клапан 1"1/4 (гибкая подводка).

Articolo	Note	CROMO	BR	O
S3756A		265,00	382,00	477,00

SA3761

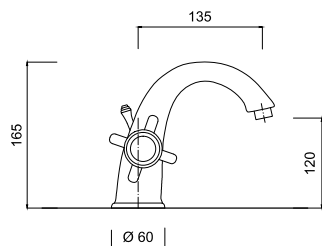

**Monoforo lavabo, scarico 1"1/4 (con flessibile)**  
Wash-basin set, 1"1/4 pop-up waste (with flexibles).  
Mélangeur lavabo monotrou, vidage 1"1/4 (avec flexibles).  
Waschtischarmatur, Ablaufgarnitur 1"1/4 (inkl. Anschlussschläuche).  
Bimando lavabo, desagüe automático 1"1/4 (con flex.).  
Комплект для раковины, донный клапан 1"1/4 (с гибкими шлангами)

Articolo	Note	CROMO	BR	O
SA3761		245,00	355,00	441,00

3713A

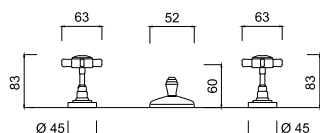

**Batteria bidet 3 fori, scarico 1"1/4**  
3-hole bidet set, 1"1/4 pop-up waste.  
Mélangeur bidet à 3 trous, vidage automatique 1"1/4.  
Bidet-Dreilochbatterie, Ablaufgarnitur 1"1/4.  
Batería bidet, tapón accionado por varilla 1"1/4.  
Комплект для биде на 3 отверстия, донный клапан 1"1/4 (гибкая подводка).

Articolo	Note	CROMO	BR	O
3713A		183,00	265,00	329,00

**3745A**

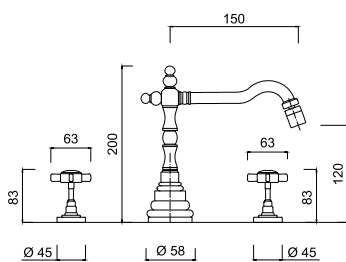

**Batteria bidet 3 fori, bocca girevole, scarico 1"1/4**

3-hole bidet set, swivel spout, 1"1/4 pop-up waste.  
Mélangeur bidet à 3 trous, bec mobile, vidage automatique 1"1/4.  
Bidet-Dreilochbatterie, Rohrauslauf, Ablaufgarnitur 1"1/4.  
Bateria bidet, caño giratorio, tapón accionado por varilla 1"1/4.  
Комплект для биде на 3 отверстия, поворотный излив, донный клапан 1"1/4 (гибкая подводка).

Articolo	Note	CROMO	BR	O
<b>3745A</b>		296,00	429,00	532,00

**S3758A**

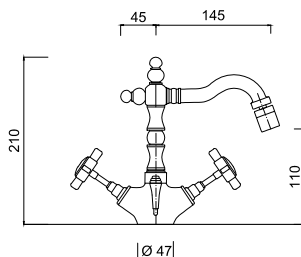

**Monoforo bidet, bocca girevole, scarico 1"1/4 (con flessibile)**

Bidet unit, swivel spout, 1"1/4 pop-up waste (with flexible).  
Mélangeur monotrou bidet, bec mobile, vidage automatique 1"1/4 (avec flex.).  
Bidet-Einlochbatterie, Rohrauslauf, Ablaufgarnitur 1"1/4 (mit flexiblen Anschlusschläuchen).  
Monobloque bidet, caño giratorio, tapón accionado por varilla 1"1/4 (con flexible).  
Смеситель для биде, поворотный излив, донный клапан 1"1/4 (гибкая подводка).

Articolo	Note	CROMO	BR	O
<b>S3758A</b>		265,00	382,00	477,00

**SA3764**

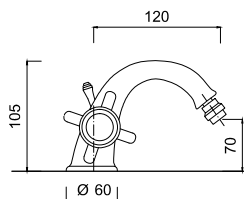

**Monoforo bidet lusso, scarico 1"1/4 (con flessibile).**

Bidet set, 1"1/4 pop-up waste (with flexibles).  
Mélangeur bidet monotrou, vidage 1"1/4 (avec flexibles).  
Bidetarmatur, Ablaufgarnitur 1"1/4 (inkl. Anschlusschläuche).  
Bimando bidé, desagüe automatico 1"1/4 (con flex.).  
Комплект для биде, донный клапан 1"1/4 (с гибкими шлангами)

Articolo	Note	CROMO	BR	O
<b>SA3764</b>		238,00	345,00	428,00

**3715W2KS**

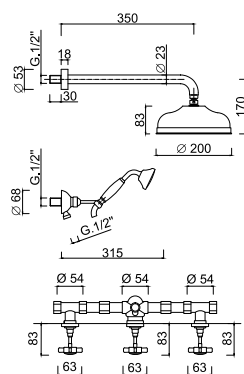

**Set doccia incasso con deviatore 2 vie, soffione ottone, kit duplex incasso**

Concealed shower taps with 2 ways diverter, brass shower head, built-in duplex shower kit  
Mélangeur douche encastré avec inverseur à 2 voies, pomme de douche en laiton, ensemble de douche duplex à encaissement  
Unterputz-Brausebatterie mit 2-Wage-Umstellung, Brausekopf in Messing, Einbau- Brauseset Duplex  
Grupo ducha empotrar con desviador 2 salidas, rociador ducha en latón, conjunto ducha duplex para empotrar  
Встроенные краны для душа с дивертером на 2 выхода, верхний душ из латуни, встроенный душевой набор "Duplex"

Articolo	Note	CROMO	BR	O
<b>3715W2KS</b>		693,00	989,00	1.234,00

**3715WB**

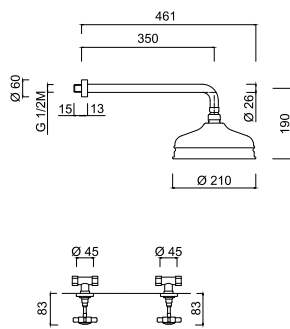

**Set doccia incasso, soffione in ottone**

Concealed shower tap, brass shower head.  
Mélangeur douche encastré, pomme de douche mural en laiton.  
Unterputz-Brausebatterie mit Kopfbrause in Messing.  
Grupo ducha empotrar con rociador en latón.  
Встроенные краны для душа, верхний душ из латуни.

Articolo	Note	CROMO	BR	O
<b>3715WB</b>		376,00	529,00	628,00

**3715W2**

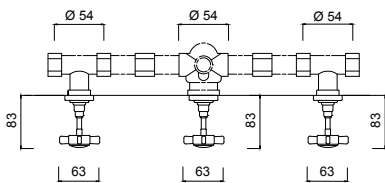

**Rubinetti incasso doccia e deviatore 2 uscite.**  
Concealed shower taps and 2 outlets diverter.  
Mélangeur douche encastré et inverseur 2 sorties.  
Unterputz-Brausebatterie mit 2-Ausgänge Umstellung.  
Grupo ducha empotrar y desviador 2 salidas.  
Встроенные краны для душа и дивертер на 2 выхода

Articolo	Note	CROMO	BR	O
<b>3715W2</b>		319,00	462,00	574,00

**3715**

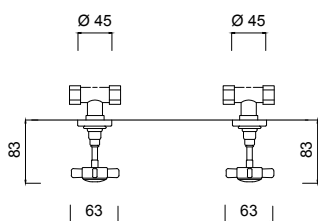

**Rubinetti incasso doccia**  
Concealed shower taps.  
Mélangeur douche encastré.  
Unterputz-Brausebatterie.  
Grupo ducha empotrar.  
Встроенные краны для душа.

Articolo	Note	CROMO	BR	O
<b>3715</b>		126,00	182,00	226,00

**1714-20**

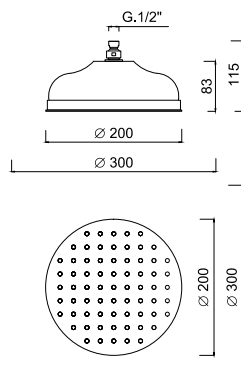

**Soffione doccia Ø 200.**  
200 mm diameter shower head.  
Pomme de douche Ø 200 mm.  
Kopfbrause, Ø 200 mm.  
Alcachofa Ø 200 mm.  
Душевая лейка с защитой от известняка Ø 200.

Articolo	Note	CROMO	BR	O
<b>1714-20</b>	mm 200	175,00	226,00	252,00
<b>1714-30</b>	mm 300	335,00	364,00	420,00

**1751-35**

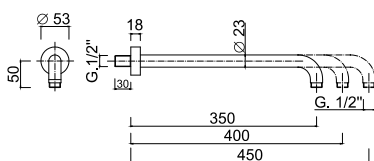

**Braccio doccia in ottone da mm 350.**  
Brass shower arm, length mm 350.  
Bras de douche, laiton chromé, longueur mm 350.  
Wandarm, mm 350 Länge, verchromtes Messing.  
Brazo ducha largo 350 mm, latón cromado.  
Душевой кронштейн из латуни, длина 350 мм.

Articolo	Note	CROMO	BR	O
<b>1751-35</b>	mm 350	78,00	121,00	150,00
<b>1751-40</b>	mm 400	83,00	•	•
<b>1751-45</b>	mm 450	98,00	•	•



1757

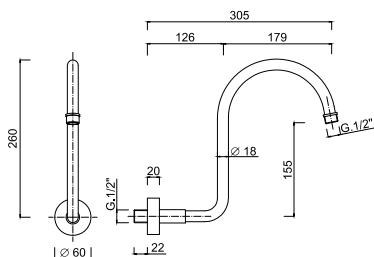

**Braccio doccia in ottone.**  
Brass shower arm.  
Bras de douche en laiton.  
Wandarm aus Messing.  
Brazo de ducha a pared en latón.  
Держатель для душа из латуни

Articolo	Note	CROMO	BR	O
1757		98,00	135,00	163,00

1762-10

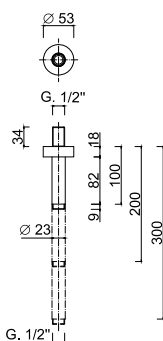

**Braccio doccia da soffitto mm.100.**  
Ceiling shower arm mm 100.  
Bras de douche vertical mm 100.  
Brausearm für Deckenmontage mm 100.  
Brazo de ducha a techo mm 100.  
Держатель душа 100 мм, потолочный

Articolo	Note	CROMO	BR	O
1762-10	mm 100	52,00	78,00	102,00
1762-20	mm 200	61,00	•	•
1762-30	mm 300	70,00	•	•

1550

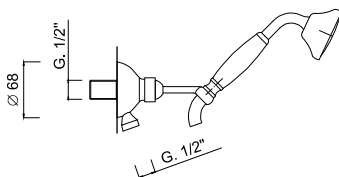

**Kit duplex incasso Londra.**  
Built-in duplex shower kit Londra.  
Ensemble de douche duplex à encaissement Londra.  
Einbaubrauseset Duplex Londra.  
Conjunto de ducha duplex para empotrar Londra.  
встроенный душевой набор "Duplex" Londra.

Articolo	Note	CROMO	BR	O
1550		124,00	180,00	258,00

3707WS

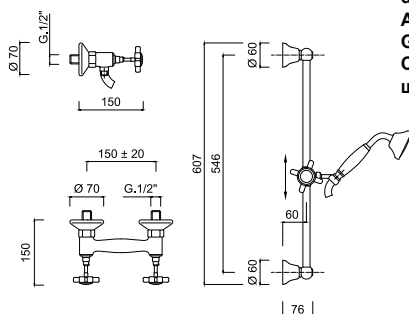

**Gruppo doccia esterno con saliscendi e doccia**  
External shower mixer with sliding rail set.  
mitigeur extérieur de douche avec barre coulissante et ensemble de douche.  
Aufputz-Brausebatterie mit Brausestange und Brauseset.  
Grupo ducha externo con conjunto ducha.  
Смеситель для душа внешнего монтажа с комплектом штанги для душа.

Articolo	Note	CROMO	BR	O
3707W2		398,00	568,00	734,00



**3707WC-S**

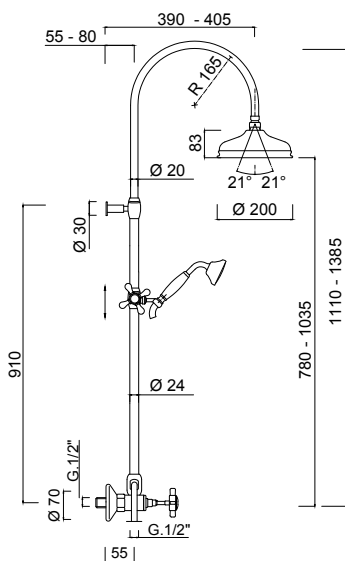

**Colonna doccia esterna, set doccia, soffione in ottone**  
External shower column, shower kit, brass shower head.  
Colonne de douche extérieure, ensemble de douche, pomme de douche en laiton.  
Aufputz-Standbrause, Brauseset, Kopfbrause in Messing.  
Columna ducha externa, conjunto de ducha, rociador en latón.  
Душевая колонна внешнего монтажа, душевой набор, верхний душ из латуни

Articolo	Note	CROMO	BR	O
<b>3707WC-S</b>		799,00	1.084,00	1.299,00

**3707**

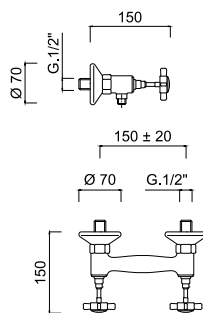

**Gruppo doccia esterno**  
External shower mixer.  
Mitigeur extérieur de douche.  
Aufputz- Brausebatterie.  
Grupo ducha externo.  
Смеситель для душа внешнего монтажа

Articolo	Note	CROMO	BR	O
<b>3707</b>		153,00	221,00	275,00

**3700WC-S**

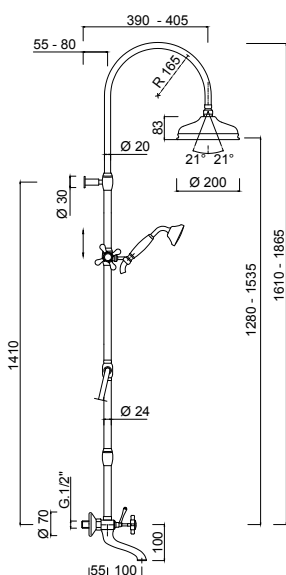

**Gruppo vasca esterno con colonna doccia, soffione ottone.**  
Wall-mounted bath set with shower column and brass showerhead.  
Mélangeur bain-douche avec colonne de douche et pomme de douche en laiton.  
AP-Wannenbatterie mit Duschsäule, Kopfbrause aus Messing.  
Conjunto bañera de superficie, rociador en latón.  
Комплект для ванны настенного монтажа с душевой колонной и верхним душем из латуни

Articolo	Note	CROMO	BR	O
<b>3700WC-S</b>		1.044,00	1.301,00	1.450,00

**3700L**

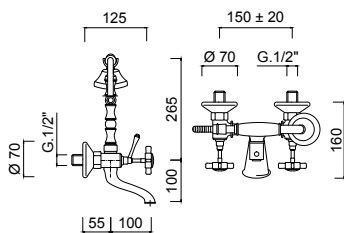

**Gruppo vasca esterno con doccia.**  
External bathtub set with shower.  
Mélangeur bain-douche extérieur avec douchette  
Wannenbatterie mit Schlauch-Handbrause nu verstellbarem  
Grupo bañera externo con ducha.  
Внешний смеситель для ванны с душевой лейкой.

Articolo	Note	CROMO	BR	O
3700L		377,00	546,00	678,00
3701L		408,00	599,00	736,00

**3700**

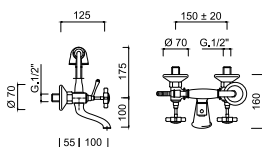

**Gruppo vasca esterno con doccia.**  
External bathtub set with shower.  
Mélangeur bain-douche extérieur avec douchette  
Wannenbatterie mit Schlauch-Handbrause nu verstellbarem  
Grupo bañera externo con ducha.  
Внешний смеситель для ванны с душевой лейкой.

Articolo	Note	CROMO	BR	O
3700		360,00	522,00	648,00
3701		391,00	575,00	706,00

**3760**

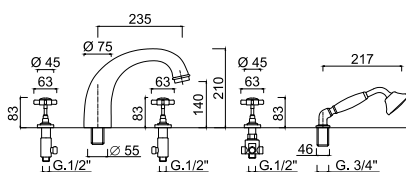

**Batteria bordo vasca 5 fori**  
5-hole bath border set.  
Groupe mitigeur à 5 trous bord baignoire.  
5-Loch Wannen Kombination.  
Bateria borde bañera 5 agujeros.  
Комплект на борт ванны на 5 отверстий.

Articolo	Note	CROMO	BR	O
3760		650,00	942,00	1.170,00

**3765**

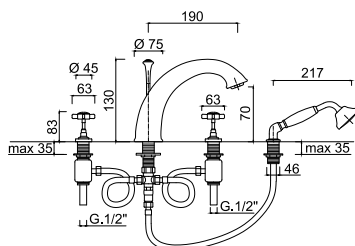

**Batteria bordo vasca 4 fori**  
4-hole bath border set.  
Groupe mitigeur à 4 trous bord baignoire.  
4-Loch Wannen Kombination.  
Bateria borde bañera 4 agujeros.  
Комплект на борт ванны на 4 отверстий.

Articolo	Note	CROMO	BR	O
3765		590,00	855,00	1.062,00

**3716**

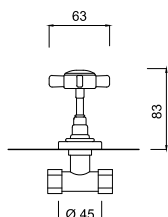

**Rubinetto incasso 1/2".**  
1/2" built-in tap.  
Robinet à encaissement 1/2".  
UP-Ventil 1/2".  
Grifo para empotrar 1/2".  
Вентиль встроенный 1/2".

Articolo	Note	CROMO	BR	O
3716		63,00	91,00	113,00

**5009**

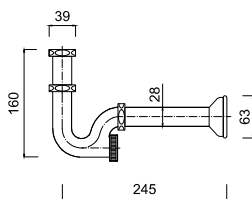

**Sifone per Lavabo 1"1/4.**  
Trap for basin 1"1/4.  
Siphon lavabo 1"1/4.  
Messing Rohrsifon 1"1/4 für Waschtisch  
Sifón para lavabo 1"1/4.  
Сифон для раковины 1"1/4

Articolo	Note	CROMO	BR	O
<b>5009</b>		40,00	75,00	116,00

**5009B**

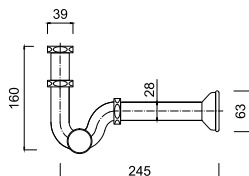

**Sifone per bidet 1"1/4.**  
Brass basin trap 1"1/4.  
Siphon bidet laiton 1"1/4.  
Messing Rohrsifon 1"1/4 für Bidet  
Sifón bidet en laiton 1"1/4.  
Сифон для умывальника из латуни 1"1/4.

Articolo	Note	CROMO	BR	O
<b>5009B</b>		40,00	75,00	116,00

**5011**

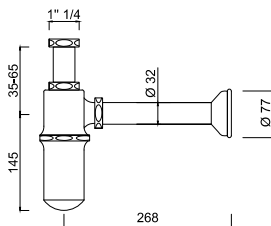

**Sifone 1" 1/4 a bottiglia.**  
Bottle trap for basin 1" 1/4.  
Siphon bouteille pour lavabo 1"1/4.  
Tassensifon 1" 1/4 für Waschtisch.  
Sifón botella para lavabo 1"1/4.  
Сифон бутылка 1" 1/4.

Articolo	Note	CROMO	BR	O
<b>5011</b>		40,00	75,00	116,00

**3063**

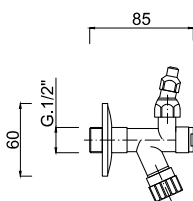

**Rubinetto con filtro con snodo.**  
Tap with filter with articulated joint.  
Robinet d'arrêt avec filter et coude.  
Eckventil mit Filter.  
Grifo con filtro con articulación.  
Смеситель с фильтром и шарниром

Articolo	Note	CROMO	AR-BR	O
<b>3063</b>		21,50	48,00	71,50

**3262**

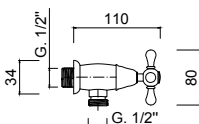

**Rubinetto sottolavabo.**  
Angle valve.  
Robinet d'arrêt sous lavabo.  
Eckventil.  
Llave de paso.  
Вентиль под раковину

Articolo	Note	CROMO	BR	O
<b>3262</b>		52,00	70,00	90,00

1585

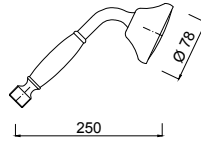

**Doccetta manopola ottone Londra.**  
Londra hand-shower brass handle.  
Douchette avec poignée en laiton Londra.  
Londra Handbrause mit Griff aus Messing.  
Ducha de teléfono empuñadura latón Londra.  
Душевая лейка с ручкой из латуни Londra.

Articolo	Note	CROMO	BR	O	
1585		61,00	73,00	95,00	

KN1597

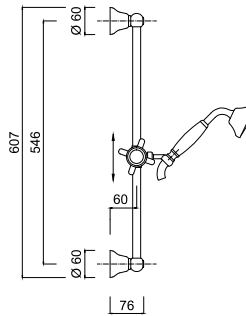

**Saliscendi maniglia Kensington con doccia Londra.**  
Sliding bar with flexible hose and Londra handshower.  
Barre de douche avec flexible et douchette Londra.  
Brausegarnitur mit Wandstange Londra.  
Barre deslizando cob flexible y ducha Londra.  
Душевая стойка Kensington с ручкой Londra.

Articolo	Note	CROMO	BR	O	
KN1597		244,00	343,00	440,00	

1510

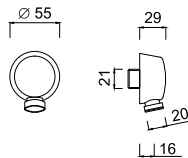

**Preso acqua 1/2"**  
Water plug 1/2"  
Prise d'eau mural 1/2"  
Wandanschlußbogen 1/2" für Brauseanschluß  
Toma de agua 1/2"  
Крепление к стене для гибкого шланга

Articolo	Note	CROMO	BR	O	
1510		16,00	24,00	33,00	

**NOTE**

**Potete trovare altre soluzioni per la Doccia nell'area WELLNESS.** p.374  
For additional Shower options please go to WELLNESS section.  
Pour plus de solutions pour la Douche visitez la section WELLNESS.  
Für weitere Duschalternativen sehen Sie bitte in dem Kapitel WELLNESS nach.  
Para más soluciones para Ducha visite la sección WELLNESS.  
Другие решения для Душа вы найдёте в разделе Wellness.

**Per gli Accessori Bagno abbinati alla serie potete consultare la serie LILIUM.** p.466  
For matching Bathroom Fittings please check LILIUM line.  
Pour les Accessoires Salle de Bains coordonnés à la collection visitez la ligne LILIUM.  
Die zu der Serie passenden Bad-Accessoires finden Sie in dem Linie LILIUM.  
Para los Accesorios de Baño compatibles con la serie visite la línea LILIUM.  
Чтобы подобрать подходящие аксессуары для ванной комнаты, перейдите в Линия LILIUM.





Parigi





**7312A**

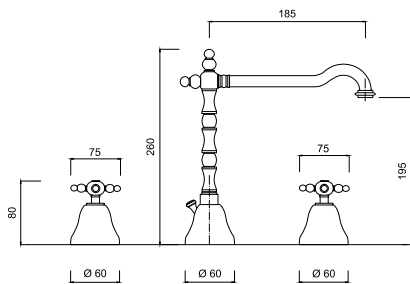

**Batteria lavabo 3 fori, bocca girevole, scarico 1"1/4**  
3-hole wash-basin set, swivel spout, 1"1/4 pop-up waste.  
Mélangeur lavabo à trois trous, bec mobile, vidage automatique 1"1/4.  
Waschtisch-Dreilochbatterie, Rohrauslauf, Ablaufgarnitur 1"1/4.  
Bateria lavabo con 3 agujeros, caño giratorio, tapón accionado por varilla 1"1/4.  
Комплект для раковины на 3 отверстия, поворотный излив, донный клапан 1"1/4

Articolo	Note	CROMO	CR	BR	O
<b>7312A</b>		284,00	312,00	397,00	511,00

**S7356A**

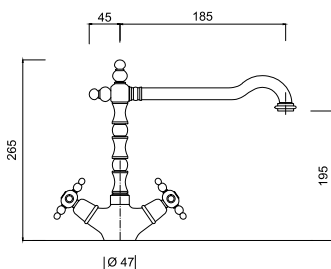

**Monoforo lavabo, bocca girevole, scarico 1"1/4 (con flessibile).**  
Wash-basin unit, swivel spout, 1"1/4 pop-up waste (with flexible).  
Mélangeur monotrou lavabo, bec mobile, vidage automatique 1"1/4 (avec flex.).  
Waschtisch-Einlochbatterie, Rohrauslauf, Ablaufgarnitur 1"1/4 (mit flexiblen Anschlussschläuchen).  
Monobloque lavabo, caño giratorio, tapón accionado por varilla 1"1/4 (con flexible).  
Смеситель для раковины, поворотный излив, донный клапан 1"1/4 (гибкая подводка).

Articolo	Note	CROMO	CR	BR	O
<b>S7356A</b>		225,00	247,00	314,00	405,00

**SA7361**

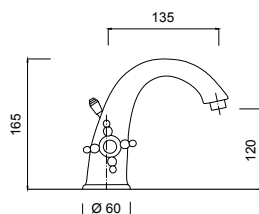

**Monoforo lavabo, scarico 1"1/4 (con flessibile).**  
Wash-basin set, 1"1/4 pop-up waste (with flexibles).  
Mélangeur lavabo monotrou, vidage 1"1/4 (avec flexibles).  
Waschtischarmatur, Ablaufgarnitur 1"1/4 (inkl. Anschlussschläuche).  
Bimando lavabo, desagüe automatico 1"1/4 (con flex.).  
Комплект для раковины, донный клапан 1"1/4 (с гибкими шлангами)

Articolo	Note	CROMO	CR	BR	O
<b>SA7361</b>		210,00	231,00	293,00	378,00

**7333**

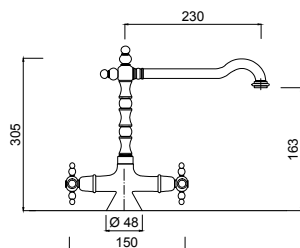

**Monoforo lavabo, bocca girevole, senza scarico (con flessibile).**  
Wash-basin set, swivel spout, without pop-up waste (with flexibles).  
Mélangeur lavabo monotrou, bec orientable, sans vidage (avec flexibles).  
Waschtischarmatur mit Schwenkauslauf, ohne Ablaufgarnitur (inkl. Anschlussschläuche).  
Monomando lavabo, caño orientable, sin desagüe automatico (con flex.).  
Комплект для раковины, поворотный излив, без донного клапана (с гибкими шлангами)

Articolo	Note	CROMO	CR	BR	O
<b>7333</b>		219,00	240,00	317,00	394,00

**7333P**

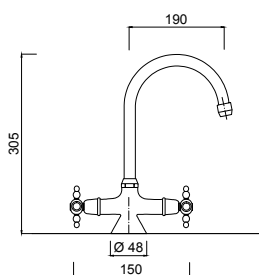

**Monoforo lavabo, bocca girevole, senza scarico (con flessibile).**  
Wash-basin set, swivel spout, without pop-up waste (with flexibles).  
Mélangeur lavabo monotrou, bec orientable, sans vidage (avec flexibles).  
Waschtischarmatur mit Schwenkauslauf, ohne Ablaufgarnitur (inkl. Anschlussschläuche).  
Monomando lavabo, caño orientable, sin desagüe automatico (con flex.).  
Комплект для раковины, поворотный излив, без донного клапана (с гибкими шлангами)

Articolo	Note	CROMO	CR	BR	O
<b>7333P</b>		164,00	180,00	237,00	295,00

7337

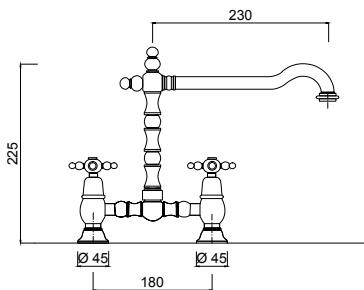

**Gruppo lavabo 2 fori, bocca girevole, senza scarico.**  
2-hole wash-basin set, swivel spout, without pop-up waste.  
Mélangeur lavabo 2 trous, bec orientable, sans vidage.  
2-Loch Waschtischbatterie mit Schwenkauslauf, ohne Ablaufgarnitur.  
Bimando lavabo 2 agujeros, caño orientable, sin desagüe automático.  
Комплект для раковины на 2 отверстия, поворотный излив, без донного клапана

Articolo	Note	CROMO	CR	BR	O
7337		282,00	310,00	408,00	507,00

7337P

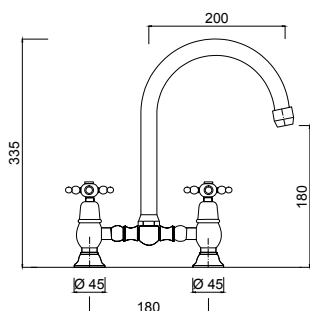

**Gruppo lavabo 2 fori, bocca girevole, senza scarico.**  
2-hole wash-basin set, swivel spout, without pop-up waste.  
Mélangeur lavabo 2 trous, bec orientable, sans vidage.  
2-Loch Waschtischbatterie mit Schwenkauslauf, ohne Ablaufgarnitur.  
Bimando lavabo 2 agujeros, caño orientable, sin desagüe automático.  
Комплект для раковины на 2 отверстия, поворотный излив, без донного клапана

Articolo	Note	CROMO	CR	BR	O
7337P		231,00	254,00	334,00	415,00

S7356AH

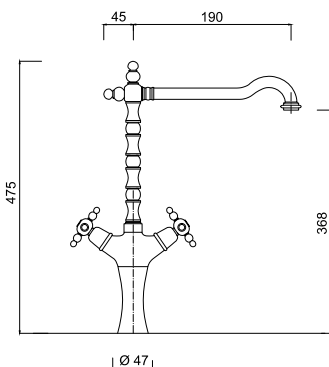

**Monoforo lavabo con prolunga, bocca girevole, scarico 1"1/4 (con flessibile).**  
Wash-basin mixer with extension, swivel spout, 1"1/4 pop-up waste (with flexibles).  
Mélangeur lavabo monotrou rehaussé, bec orientable, vidage 1"1/4 (avec flexibles).  
Hohe Waschtischarmatur mit Schwenkauslauf, Ablaufgarnitur 1"1/4 (inkl. Anschlussschläuche).  
Bimando lavabo alto, caño orientable, desagüe automático 1"1/4 (con flex.).  
Смеситель для раковины с удлинением, поворотным изливом, с донным клапаном на 1"1/4 (с гибкими шлангами)

Articolo	Note	CROMO	CR	BR	O
S7356AH		303,00	333,00	423,00	545,00

7322

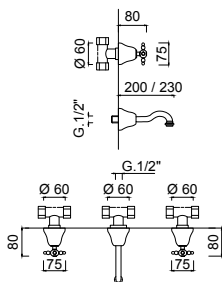

**Lavabo 3 fori a muro, bocca mm.200/230, senza scarico.**  
Wall-mounted 3-hole wash-basin set, spout mm 200/230, without pop-up waste.  
Mélangeur lavabo mural 3 trous, bec mm 200/230, sans vidage.  
3-Loch Waschtischarmatur für die Wandmontage, Auslauf mm 200/230, ohne Ablaufgarnitur.  
Bimando lavabo mural 3 agujeros, caño mm 200/230, sin desagüe automático.  
Комплект для раковины на 3 отверстия настенного монтажа, излив 200/230 мм., без донного клапана

Articolo	Note	CROMO	CR	BR	O
7322		199,00	218,00	278,00	358,00

7323

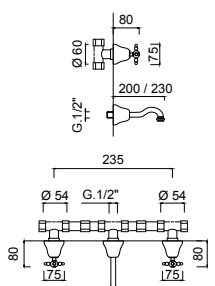

**Lavabo 3 fori a muro, bocca mm.200, senza scarico (con connessioni).**  
Wall-mounted 3-hole wash-basin set, spout mm 200, without pop-up waste (with connections).  
Mélangeur lavabo mural 3 trous, bec mm 200, sans vidage (avec les contacteurs).  
3-Loch Waschtischarmatur für die Wandmontage, Auslauf mm 200, ohne Ablaufgarnitur. (mit Verbindungen).  
Bimando lavabo mural 3 agujeros, caño mm 200, sin desagüe automático. (con conexiones).  
Комплект для раковины на 3 отверстия настенного монтажа, излив 200 мм., без донного клапана (с соединениями)

Articolo	Note	CROMO	CR	BR	O
7323		244,00	268,00	341,00	439,00

**7313A**

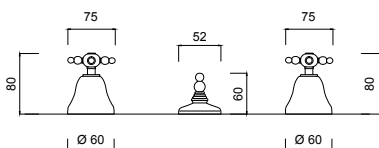

**Batteria bidet 3 fori, scarico 1"1/4.**  
3-hole bidet set, 1"1/4 pop-up waste.  
Mélangeur bidet 3 trous, vidage 1"1/4 (avec flexibles).  
3-Loch Bidetarmatur, Ablaufgarnitur 1"1/4.  
Grifo de bidé 3 agujeros, desagüe automático 1"1/4.  
Комплект для биде на 3 отверстия, донный клапан 1"1/4

Articolo	Note	CROMO	CR	BR	O
<b>7313A</b>		182,00	200,00	263,00	327,00

**7345A**

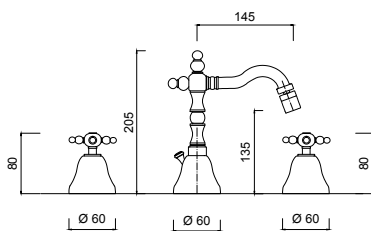

**Batteria bidet 3 fori, bocca girevole, scarico 1"1/4**  
3-hole bidet set, swivel spout, 1"1/4 pop-up waste.  
Mélangeur bidet à 3 trous, bec mobile, vidage automatique 1"1/4.  
Bidet-Dreilochbatterie, Rohrauslauf, Ablaufgarnitur 1"1/4.  
Batería bidet, caño giratorio, tapón accionado por varilla 1"1/4.  
Комплект для биде на 3 отверстия, поворотный излив, донный клапан 1"1/4 (гибкая подводка).

Articolo	Note	CROMO	CR	BR	O
<b>7345A</b>		293,00	322,00	424,00	527,00

**S7358A**

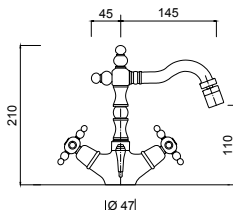

**Monoforo bidet, bocca girevole, scarico 1"1/4 (con flessibile)**  
Bidet unit, swivel spout, 1"1/4 pop-up waste (with flexible).  
Mélangeur monotrou bidet, bec mobile, vidage automatique 1"1/4 (avec flex.).  
Bidet-Einlochbatterie, Rohrauslauf, Ablaufgarnitur 1"1/4 (mit flexiblen Anschlusschläuchen).  
Monobloque bidet, caño giratorio, tapón accionado por varilla 1"1/4 (con flexible).  
Смеситель для биде, поворотный излив, донный клапан 1"1/4 (гибкая подводка).

Articolo	Note	CROMO	CR	BR	O
<b>S7358A</b>		210,00	231,00	293,00	378,00

**SA7364**

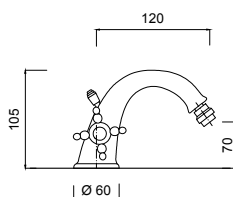

**Monoforo bidet, scarico 1"1/4 (con flessibile).**  
Bidet set, 1"1/4 pop-up waste (with flexibles).  
Mélangeur bidet monotrou, vidage 1"1/4 (avec flexibles).  
Bidetarmatur, Ablaufgarnitur 1"1/4 (inkl. Anschlusschläuche).  
Bimando bidé, desagüe automático 1"1/4 (con flex.).  
Комплект для биде, донный клапан 1"1/4 (с гибкими шлангами)

Articolo	Note	CROMO	CR	BR	O
<b>SA7364</b>		210,00	231,00	293,00	378,00

**7335**

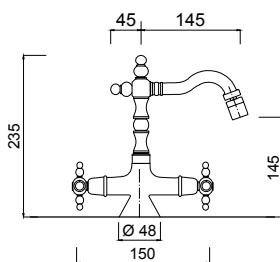

**Monoforo bidet, bocca girevole, senza scarico (con flessibile).**  
Bidet set, swivel spout, without pop-up waste (with flexibles).  
Mélangeur bidet monotrou, bec orientable, sans vidage (avec flexibles).  
Bidetarmatur mit Schwenkauslauf, ohne Ablaufgarnitur (inkl. Anschlusschläuche).  
Bimando bidé, caño orientable, sin desagüe automático (con flex.).  
Комплект для биде, поворотный излив, без донного клапана (с гибкими шлангами)

Articolo	Note	CROMO	CR	BR	O
<b>7335</b>		219,00	240,00	317,00	394,00

**7335P**

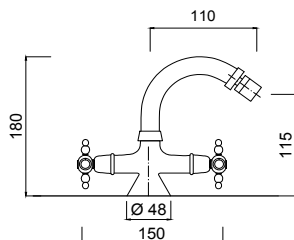

**Monoforo bidet, bocca girevole, senza scarico (con flessibile).**  
Bidet set, swivel spout, without pop-up waste (with flexibles).  
Mitigeur bidet monotrou, bec orientable, sans vidage (avec flexibles).  
Bidetarmatur mit Schwenkauslauf, ohne Ablaufgarnitur (inkl. Anschlusschläuche).  
Bimando bidé, caño orientable, sin desagüe automático (con flex.).  
Комплект для биде, поворотный излив, без донного клапана (с гибкими шлангами)

Articolo	Note	CROMO	CR	BR	O
<b>7335P</b>		164,00	180,00	237,00	295,00

**7316W2KB**

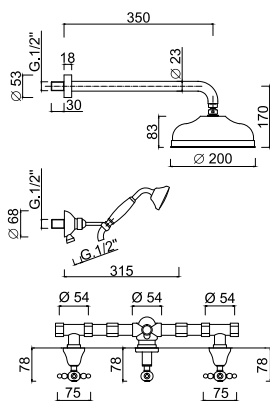
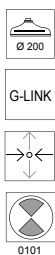

**Set doccia incasso con deviatore 2 vie, soffione ottone , kit duplex incasso.**  
Built-in shower set with 2-way diverter, brass showerhead , duplex shower kit.  
Mélangeur douche à encastrer avec inverseur à 2 sorties, pomme de douche en laiton , ensemble de douche.  
UP-Brausearmatur mit 2-Wege-Umstellung, Kopfbrause aus Messing , UP-Brauseset.  
Termostática ducha empotrada con inversor 2 vías, rociador en latón , kit de ducha empotrado.  
Встраиваемый комплект для душа с дивертером на 2 выхода, верхний душ из латуни 250 мм, душевой набор "duplex"

Articolo	Note	CROMO	CR	BR	O
<b>7316W2KB</b>		666,00	733,00	908,00	1.147,00

**7316W2**

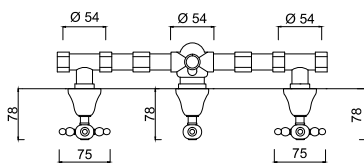
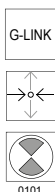

**Rubinetti incasso doccia e deviatore 2 uscite.**  
Concealed shower taps and 2 outlets diverter.  
Mélangeur douche encastré et inverseur 2 sorties.  
Unterputz-Brausebatterie mit 2-Ausgänge Umstellung.  
Grupo ducha empotrar y desviador 2 salidas.  
Встроенные краны для душа и дивертер на 2 выхода

Articolo	Note	CROMO	CR	BR	O
<b>7316W2</b>		293,00	322,00	408,00	527,00

**7316W3**

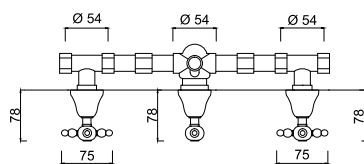
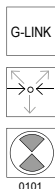

**Rubinetti incasso doccia e deviatore 3 uscite.**  
Concealed shower taps and 3 outlets diverter.  
Mélangeur douche encastré et inverseur 3 sorties.  
Unterputz-Brausebatterie mit 3-Ausgänge Umstellung.  
Grupo ducha empotrar y desviador 3 salidas.  
Встроенные краны для душа и дивертер на 3 выхода

Articolo	Note	CROMO	CR	BR	O
<b>7316W3</b>		323,00	355,00	468,00	581,00



### 8212-PALN



T<sub>38°</sub>

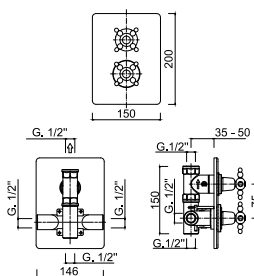

**Termostatico incasso 1/2", con rubinetto d'arresto 1/2".**  
Built-in thermostatic mixer 1/2", with built-in tap 1/2".  
Mitigeur thermostatique mural, 1/2", avec robinet mural 1/2".  
Eingebaute Einhebel Thermostatbatterie 1/2", mit Ventil 1/2".  
Mezclador termostatico a empotrar 1/2", con grifo 1/2".  
Встраиваемый термостат 1/2" со встраиваемым смесителем 3/4".

Articolo	Note	CROMO	CR	BR	O
8212-PALN		470,00	528,00	657,00	750,00

### 8213-PALN



T<sub>38°</sub>

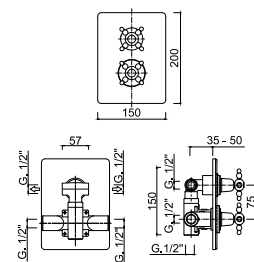

**Termostatico incasso 2 uscite**  
2 outlets built-in thermostatic mixer  
Mitigeur thermostatique mural à 2 sorties  
2-Ausgänge eingebaute Einhebel-Thermostatbatterie  
Mezclador termostatico a empotrar a 2 salidas.  
Встроенный термостатический смеситель на 2 выхода

Articolo	Note	CROMO	CR	BR	O
8213-PALN		520,00	583,00	727,00	830,00

### 8282-LN



G-BOX  
T<sub>38°</sub>

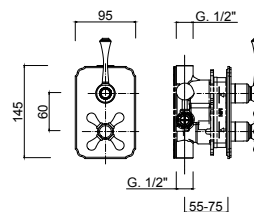

**Termostatico incasso 2 uscite, box incasso.**  
Built-in thermostatic mixer with 2 outlets, built-in box.  
Mitigeur thermostatique douche à encastrer avec 2 sorties, box d'encastrement.  
UP-Thermostat mit 2-Wege-Umstellung, inkl. Box.  
Termostática empotrada 2 salidas, box empotrado incluido.  
Встраиваемый термостатический смеситель с 2 выходами, встраиваемый бокс

Articolo	Note	CROMO	CR	BR	O
8282-LN		840,00	882,00	1.092,00	1.260,00

### 8283-LN



G-BOX  
T<sub>38°</sub>

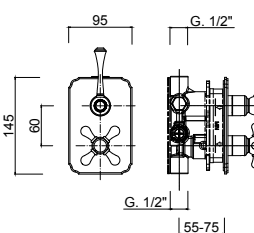

**Termostatico incasso 3 uscite, box incasso.**  
Built-in thermostatic mixer with 3 outlets, built-in box.  
Mitigeur thermostatique douche à encastrer avec 3 sorties, box d'encastrement.  
UP-Thermostat mit 3-Wege-Umstellung, inkl. Box.  
Termostática empotrada 3 salidas, box empotrado incluido.  
Встраиваемый термостатический смеситель с 3 выходами, встраиваемый бокс

Articolo	Note	CROMO	CR	BR	O
8283-LN		890,00	934,00	1.157,00	1.335,00

### 1714-20

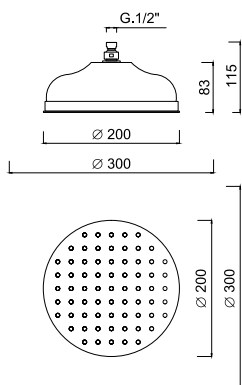

**Soffione doccia Ø 200.**  
200 mm diameter shower head.  
Pomme de douche Ø 200 mm.  
Kopfbrause, Ø 200 mm.  
Alcachofa Ø 200 mm.  
Душевая лейка с защитой от известняка Ø 200.

Articolo	Note	CROMO	CR	BR	O
1714-20	mm 200	171,00	•	205,00	229,00
1714-30	mm 300	335,00	•	364,00	420,00

1751-35

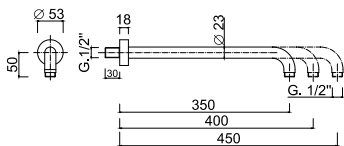

**Braccio doccia in ottone da mm 350.**  
Brass shower arm, length mm 350.  
Bras de douche, laiton chromé, longueur mm 350.  
Wandarm, mm 350 Länge, verchromtes Messing.  
Brazo ducha largo 350 mm, latón cromado.  
Душевой кронштейн из латуни, длина 350 мм.

Articolo	Note	CROMO	CR	BR	O
1751-35	mm 350	78,00	•	121,00	150,00
1751-40	mm 400	83,00	•	•	•
1751-45	mm 450	98,00	•	•	•

1757

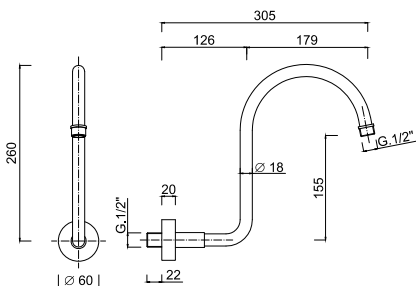

**Braccio doccia in ottone.**  
Brass shower arm.  
Bras de douche en laiton.  
Wandarm aus Messing.  
Brazo de ducha a pared en latón.  
Держатель для душа из латуни

Articolo	Note	CROMO	CR	BR	O
1757		98,00	•	153,00	163,00

1762-10

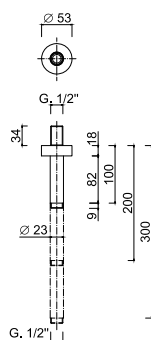

**Braccio doccia da soffitto mm.100.**  
Ceiling shower arm mm 100.  
Bras de douche vertical mm 100.  
Brausearm für Deckenmontage mm 100.  
Brazo de ducha a techo mm 100.  
Держатель душа 100 мм, потолочный

Articolo	Note	CROMO	CR	BR	O
1762-10	mm 100	52,00	•	78,00	102,00
1762-20	mm 200	61,00	•	•	•
1762-30	mm 300	70,00	•	•	•

1550

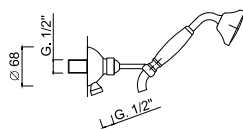

**Kit duplex incasso Londra.**  
Built-in duplex shower kit Londra.  
Ensemble de douche duplex à encaissement Londra.  
Einbaubrauseset Duplex Londra.  
Conjunto de ducha duplex para empotrar Londra.  
встроенный душевой набор "Duplex" Londra.

Articolo	Note	CROMO	CR	BR	O
1550		124,00	136,00	180,00	258,00

7307WS

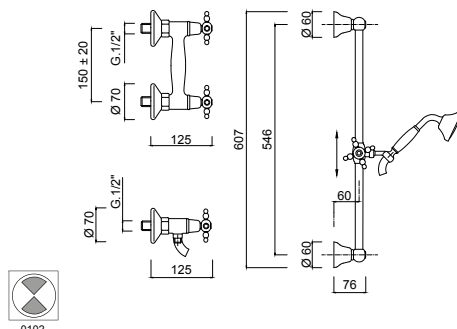

**Gruppo doccia esterno con saliscendi e doccia**  
External shower mixer with sliding rail set.  
mitigeur extérieur de douche avec barre coulissante et ensemble de douche.  
Aufputz-Brausebatterie mit Brausestange und Brauseset.  
Grupo ducha externo con conjunto ducha.  
Смеситель для душа внешнего монтажа с комплектом штанги для душа.

Articolo	Note	CROMO	CR	BR	O
7307WS		371,00	408,00	525,00	668,00



**7307WC-S**

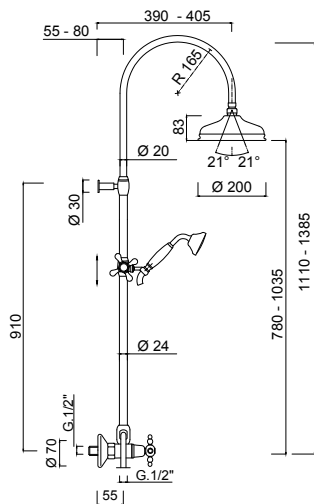

**Colonna doccia esterna, set doccia, soffione in ottone**  
 External shower column, shower kit, brass shower head.  
 Colonne de douche extérieure, ensemble de douche, pomme de douche en laiton.  
 Aufputz-Standbrause, Brauseset, Kopfbrause in Messing.  
 Columna ducha externa, conjunto de ducha, rociador en latón.  
 Душевая колонна внешнего монтажа, душевой набор, верхний душ из латуни

Articolo	Note	CROMO	CR	BR	O
<b>7307WC-S</b>		835,00	918,00	1.061,00	1.205,00

**8209-PAWC-S**

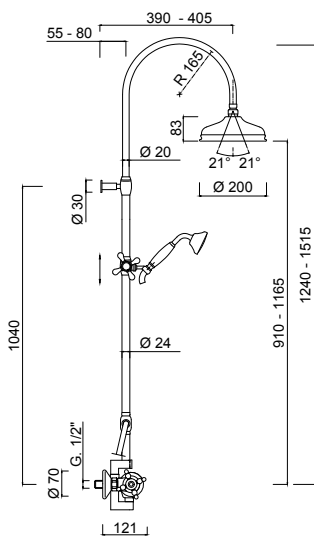

**Colonna doccia esterna termostatica, set doccia, soffione in ottone**  
 External thermostatic shower column, shower kit, brass shower head  
 Colonne de douche avec mélangeur thermostatique, ensemble de douche, pomme de douche en laiton  
 Aufputz-Standbrause mit Thermostat-Brausebatterie, Brauseset, Kopfbrause in Messing  
 Columna ducha con mezclador termostático, conjunto de ducha, rociador ducha en latón  
 Термостатическая душевая колонна внешнего монтажа, душевой набор, верхний душ из латуни

Articolo	Note	CROMO	CR	BR	O
<b>8209-PAWC-S</b>		1.321,00	1.453,00	1.691,00	1.918,00

7307

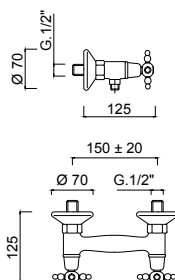

**Gruppo doccia esterno**

External shower mixer.  
Mitigeur extérieur de douche.  
Aufputz- Brausebatterie.  
Grupo ducha externo.  
Смеситель для душа внешнего монтажа

Articolo	Note	CROMO	CR	BR	O
7307		125,00	137,00	181,00	225,00

8209-PA

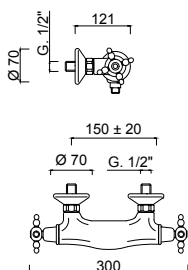

**Miscelatore termostatico doccia esterno.**

External shower thermostatic mixer.  
Mélangeur thermostatique pour douche.  
Thermostat-Brausebatterie.  
Mezclador termostático externo ducha.  
Термостатический смеситель для внешнего душа.

Articolo	Note	CROMO	CR	BR	O
8209-PA		433,00	476,00	588,00	720,00

7300WC-S

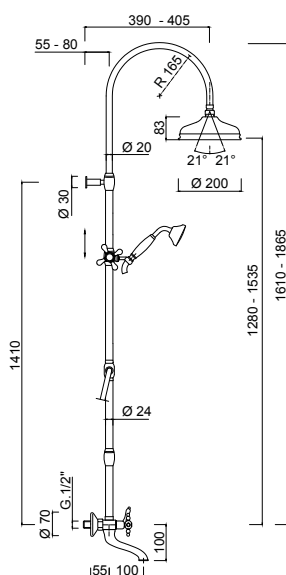

**Gruppo vasca esterno con colonna doccia, soffione ottone.**

Wall-mounted bath set with shower column and brass showerhead.  
Mélangeur bain-douche avec colonne de douche et pomme de douche en laiton.  
AP-Wannenbatterie mit Duschsäule, Kopfbrause aus Messing.  
Conjunto bañera de superficie, rociador en latón.  
Комплект для ванны настенного монтажа с душевой колонной и верхним душем из латуни

Articolo	Note	CROMO	CR	BR	O
7300WC-S		1.034,00	1.137,00	1.499,00	1.861,00



**7300CB**

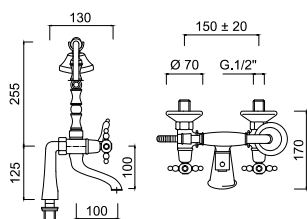

**Gruppo vasca esterno con set doccia, colonne bordo vasca.**  
Wall-mounted bath set with shower kit, deck mounted tap legs.  
Mélangeur bain-douche avec ensemble de douche et colonnes sur gorge.  
AP-Wannenbatterie mit Brauseset, Standfüßen.  
Bimando bañera con kit de ducha, codos para batería de repisa.  
Комплект для ванны настенного монтажа с душевым набором, держатели для смесителя на край ванны

Articolo	Note	CROMO	CR	BR	O
<b>7300CB</b>		431,00	474,00	624,00	775,00

**7300CT**

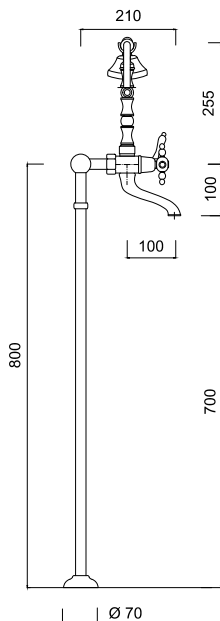

**Gruppo vasca esterno con doccia con colonne a pavimento.**  
External bathtub set with floor pillar legs, flexible hose and hand shower.  
Mélangeur bain/douche avec colonnettes alimentation par le sol, flexible, douchette.  
Wannenbatterie mit Standfüßen, Schlauch und Handbrause.  
Grupo bañera externo con columnas a pavimento, flexible y ducha.  
Внешний смеситель для ванны на опорных ножках для напольной установки с душевой лейкой.

Articolo	Note	CROMO	CR	BR	O
<b>7300CT</b>		775,00	854,00	1.080,00	1.251,00

**7301**

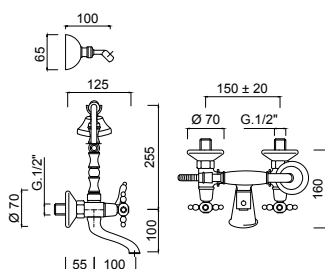

**Gruppo vasca esterno con set doccia duplex**  
External bathtub set with duplex shower kit.  
Mélangeur bain-douche extérieur avec ensemble de douche duplex.  
Wannenbatterie mit Schlauch-Handbrause und verstellbarem Wandhalter.  
Grupo bañera externo con conjunto de ducha duplex.  
Комплект для ванны внешнего монтажа с душевым набором "Duplex".

Articolo	Note	CROMO	CR	BR	O
<b>7301</b>		369,00	405,00	535,00	664,00

**7300**

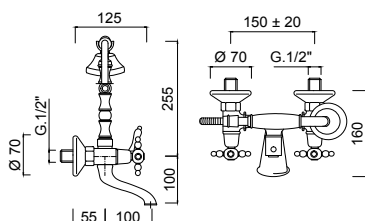

**Gruppo vasca esterno con doccia.**  
External bathtub set with shower.  
Mélangeur bain-douche extérieur avec douchette.  
Wannenbatterie mit Schlauch-Handbrause nu verstellbarem.  
Grupo bañera externo con ducha.  
Внешний смеситель для ванны с душевой лейкой

Articolo	Note	CROMO	CR	BR	O
<b>7300</b>		345,00	379,00	464,00	621,00

7360

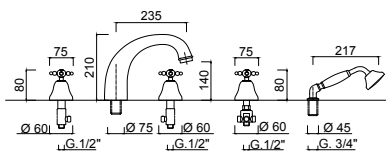

**Batteria bordo vasca 5 fori**

5-hole bath border set.  
Groupe mitigeur à 5 trous bord baignoire.  
5-Loch Wannen Kombination.  
Bateria borde bañera 5 agujeros.  
Комплект на борт ванны на 5 отверстий.

Articolo	Note	CROMO	CR	BR	O
7360		630,00	693,00	913,00	1.134,00

7365

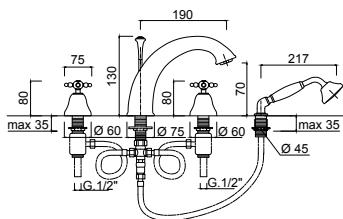

**Batteria bordo vasca 4 fori**

4-hole bath border set.  
Groupe mitigeur à 4 trous bord baignoire.  
4-Loch Wannen Kombination.  
Bateria borde bañera 4 agujeros.  
Комплект на борт ванны на 4 отверстий.

Articolo	Note	CROMO	CR	BR	O
7365		560,00	616,00	812,00	1.008,00

7316

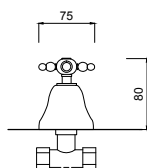

**Rubinetto incasso 1/2".**

1/2" built-in tap.  
Robinet à encaissement 1/2".  
UP-Ventil 1/2".  
Grifo para empotrar 1/2".  
Вентиль встроенный 1/2".

Articolo	Note	CROMO	CR	BR	O
7316		67,00	73,00	97,00	120,00

5009

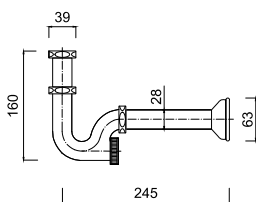

**Sifone per Lavabo 1"1/4.**

Trap for basin 1"1/4.  
Siphon lavabo 1"1/4.  
Messing Rohrsifon 1"1/4 für Waschtisch  
Sifón para lavabo 1"1/4.  
Сифон для раковины 1"1/4

Articolo	Note	CROMO	CR	BR	O
5009		40,00	•	75,00	116,00

5009B

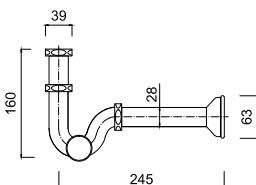

**Sifone per bidet 1"1/4.**

Brass basin trap 1"1/4.  
Siphon bidet laiton 1"1/4.  
Messing Rohrsifon 1"1/4 für Bidet  
Sifón bidet en laiton 1"1/4.  
Сифон для умывальника из латуни 1"1/4.

Articolo	Note	CROMO	CR	BR	O
5009B		40,00	•	75,00	116,00

5011

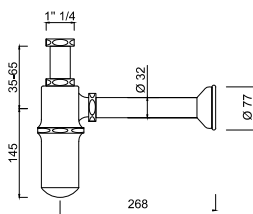

**Sifone 1" 1/4 a bottiglia.**  
*Bottle trap for basin 1" 1/4.*  
*Siphon bouteille pour lavabo 1"1/4.*  
*Tassensifon 1" 1/4 für Waschtisch.*  
*Sifón botella para lavabo 1"1/4.*  
*Сифон бутылка 1" 1/4.*

Articolo	Note	CROMO	CR	BR	O
5011		40,00	•	75,00	116,00

3063

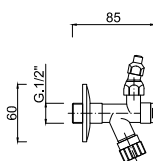

**Rubinetto con filtro con snodo.**  
*Tap with filter with articulated joint.*  
*Robinet d'arrêt avec filtre et coude*  
*Eckventil mit Filter*  
*Llave de regulaciòn con filtro*  
*Смеситель с фильтром и шарниром*

Articolo	Note	CROMO	CR	BR	O
3063		21,50	•	48,00	71,50

3262

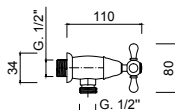

**Rubinetto sottolavabo.**  
*Angle valve.*  
*Robinet d'arrêt sous lavabo.*  
*Eckventil.*  
*Llave de paso.*  
*Вентиль под раковину*

Articolo	Note	CROMO	CR	BR	O
3262		52,00	•	70,00	90,00

1585

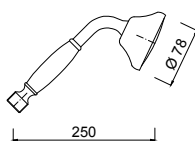

**Doccetta manopola ottone Londra.**  
*Londra hand-shower brass handle.*  
*Douchette avec poignée en laiton Londra.*  
*Londra Handbrause mit Griff aus Messing.*  
*Ducha de teléfono empuñadura latón Londra.*  
*Душевая лейка с ручкой из латуни Londra.*

Articolo	Note	CROMO	CR	BR	O
1585		61,00	•	73,00	95,00

PA1597

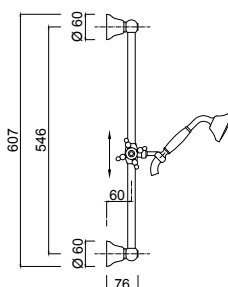

**Saliscendi maniglia Parigi con doccia Londra.**  
*Sliding bar with flexible hose and Londra handshower.*  
*Barre de douche avec flexible et douchette Londra.*  
*Brausegarnitur mit Wandstange Londra.*  
*Barre deslizante cob flexible y ducha Londra.*  
*Душевая стойка Parigi с ручкой Londra.*

Articolo	Note	CROMO	CR	BR	O
PA1597		242,00	270,00	340,00	438,00

1510

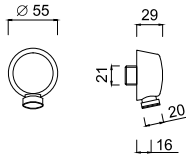

**Presca acqua 1/2".**

*Water plug 1/2".*

*Prise d'eau mural 1/2".*

*Wandanschlussbogen 1/2" für Brauseanschl.*

*Toma de agua 1/2".*

*Крепление к стене для гибкого шланга*

Articolo	Note	CROMO	CR	BR	O
1510		16,00	•	24,00	33,00

0128



**Tubetto Ø 10 cm 35 con cartella e calotta.**

*Ø 10 cm 35 connection pipe with casing and cap.*

*Tuyaus Ø 10 cm 35 avec bordure.*

*Gebogene Schläuche Ø 10 cm 35 mit Rand.*

*Tubito Ø 10 cm 35 con revestimiento y casquete.*

*Трубка Ø 10 см 35 с креплением и колпаком*

Articolo	Note	CROMO	CR	BR	O
0128		7,20	•	13,00	18,00

**NOTE**

**Potete trovare altre soluzioni per la Doccia nell'area WELLNESS. p.374**

*For additional Shower options please go to WELLNESS section.*

*Pour plus de solutions pour la Douche visitez la section WELLNESS.*

*Für weitere Duschalternativen sehen Sie bitte in dem Kapitel WELLNESS nach.*

*Para más soluciones para Ducha visite la sección WELLNESS.*

*Другие решения для Душа вы найдете в разделе Wellness.*

**Per gli Accessori Bagno abbinati alla serie potete consultare la serie LILIUM. p.466**

*For matching Bathroom Fittings please check LILIUM line.*

*Pour les Accessoires Salle de Bains coordonnés à la collection visitez la ligne LILIUM.*

*Die zu der Serie passenden Bad-Accessoires finden Sie in dem Linie LILIUM.*

*Para los Accesorios de Baño compatibles con la serie visite la línea LILIUM.*

*Чтобы подобрать подходящие аксессуары для ванной комнаты, перейдите в Линия LILIUM*



Londra





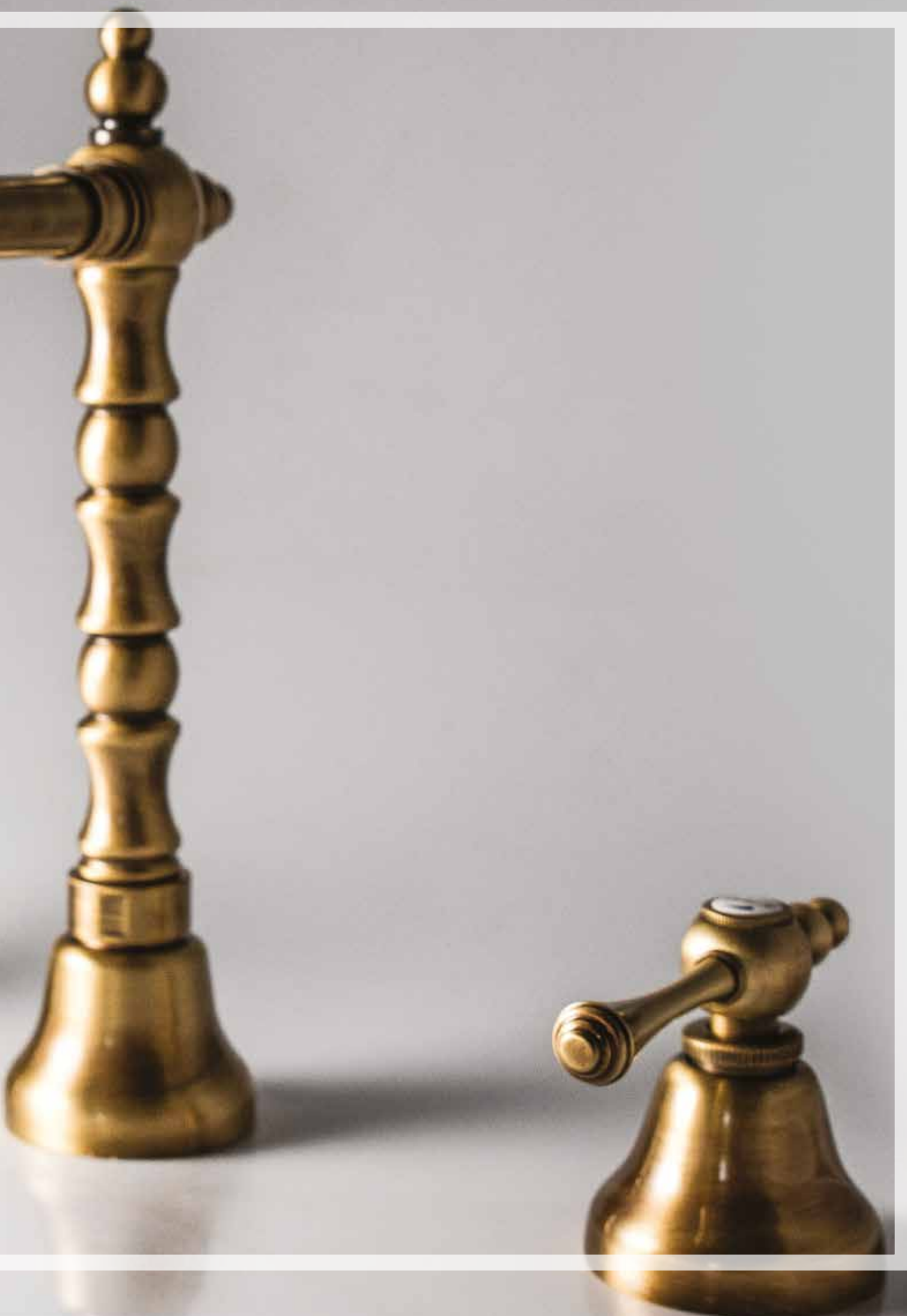

**7212A**

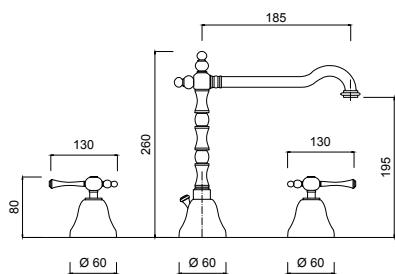

**Batteria lavabo 3 fori, bocca girevole, scarico 1"1/4**  
3-hole wash-basin set, swivel spout, 1"1/4 pop-up waste.  
Mélangeur lavabo à trois trous, bec mobile, vidage automatique 1"1/4.  
Waschtisch-Dreilochbatterie, Rohrauslauf, Ablaufgarnitur 1"1/4.  
Batería lavabo con 3 agujeros, caño giratorio, tapón accionado por varilla 1"1/4.  
Комплект для раковины на 3 отверстия, поворотный излив, донный клапан 1"1/4

Articolo	Note	CROMO	CR	BR	O
<b>7212A</b>		284,00	312,00	397,00	511,00

**S7256A**

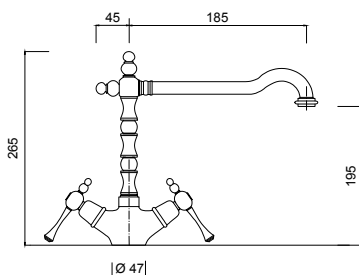

**Monoforo lavabo, bocca orientabile, scarico 1"1/4 (con flessibile).**  
Wash-basin unit, swivel spout, 1"1/4 pop-up waste (with flexible).  
Mélangeur monotrou lavabo, bec mobile, vidage automatique 1"1/4 (avec flex.).  
Waschtisch-Einlochbatterie, Rohrauslauf, Ablaufgarnitur 1"1/4 (mit flexiblen Anschlusschläuchen).  
Monobloque lavabo, caño giratorio, tapón accionado por varilla 1"1/4 (con flexible).  
Смеситель для раковины, поворотный излив, донный клапан 1"1/4 (гибкая подводка).

Articolo	Note	CROMO	CR	BR	O
<b>S7256A</b>		225,00	247,00	314,00	405,00

**SA7261**

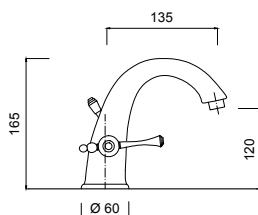

**Monoforo lavabo, scarico 1"1/4 (con flessibile).**  
Wash-basin set, 1"1/4 pop-up waste (with flexibles).  
Mélangeur lavabo monotrou, vidage 1"1/4 (avec flexibles).  
Waschtischarmatur, Ablaufgarnitur 1"1/4 (inkl. Anschlusschläuche).  
Bimando lavabo, desagüe automático 1"1/4 (con flex.).  
Комплект для раковины, донный клапан 1"1/4 (с гибкими шлангами)

Articolo	Note	CROMO	CR	BR	O
<b>SA7261</b>		210,00	231,00	293,00	378,00

**7233**

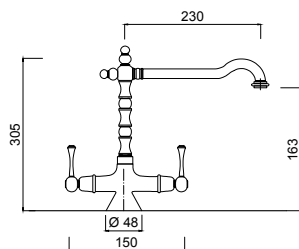

**Monoforo lavabo, bocca orientabile, senza scarico (con flessibile).**  
Wash-basin set, swivel spout, without pop-up waste (with flexibles).  
Mélangeur lavabo monotrou, bec orientable, sans vidage (avec flexibles).  
Waschtischarmatur mit Schwenkauslauf, ohne Ablaufgarnitur (inkl. Anschlusschläuche).  
Monomando lavabo, caño orientable, sin desagüe automático (con flex.).  
Комплект для раковины, поворотный излив, без донного клапана (с гибкими шлангами)

Articolo	Note	CROMO	CR	BR	O
<b>7233</b>		219,00	240,00	317,00	394,00

**7233P**

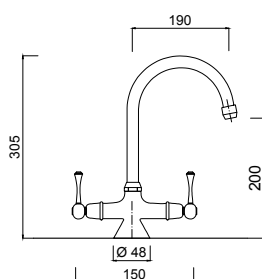

**Monoforo lavabo, bocca girevole, senza scarico (con flessibile).**  
Wash-basin set, swivel spout, without pop-up waste (with flexibles).  
Mélangeur lavabo monotrou, bec orientable, sans vidage (avec flexibles).  
Waschtischarmatur mit Schwenkauslauf, ohne Ablaufgarnitur (inkl. Anschlusschläuche).  
Monomando lavabo, caño orientable, sin desagüe automático (con flex.).  
Комплект для раковины, поворотный излив, без донного клапана (с гибкими шлангами)

Articolo	Note	CROMO	CR	BR	O
<b>7233P</b>		164,00	180,00	237,00	295,00

7237

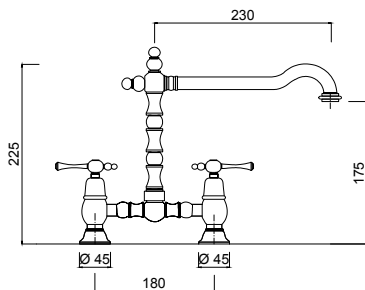

**Gruppo lavabo 2 fori, bocca girevole, senza scarico.**  
2-hole wash-basin set, swivel spout, without pop-up waste.  
Mélangeur lavabo 2 trous, bec orientable, sans vidage.  
2-Loch Waschtischbatterie mit Schwenkauslauf, ohne Ablaufgarnitur.  
Bimando lavabo 2 agujeros, caño orientable, sin desagüe automático.  
Комплект для раковины на 2 отверстия, поворотный излив, без донного клапана

Articolo	Note	CROMO	CR	BR	O
7237		282,00	310,00	408,00	507,00

7237P

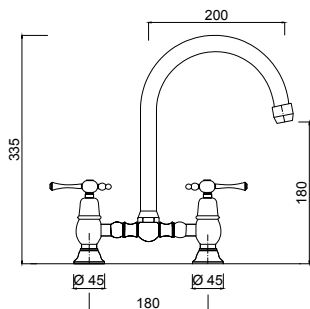

**Gruppo lavabo 2 fori, bocca girevole, senza scarico.**  
2-hole wash-basin set, swivel spout, without pop-up waste.  
Mélangeur lavabo 2 trous, bec orientable, sans vidage.  
2-Loch Waschtischbatterie mit Schwenkauslauf, ohne Ablaufgarnitur.  
Bimando lavabo 2 agujeros, caño orientable, sin desagüe automático.  
Комплект для раковины на 2 отверстия, поворотный излив, без донного клапана

Articolo	Note	CROMO	CR	BR	O
7237P		231,00	254,00	334,00	415,00

S7256AH

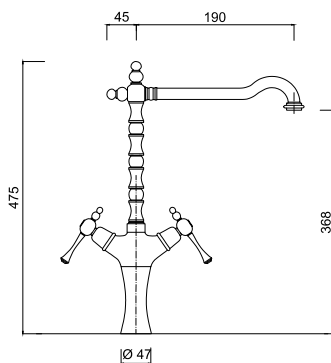

**Monoforo lavabo con prolunga, bocca girevole, scarico 1"1/4 (con flessibile).**  
Wash-basin mixer with extension, swivel spout, 1"1/4 pop-up waste (with flexibles).  
Mélangeur lavabo monotrou rehaussé, bec orientable, vidage 1"1/4 (avec flexibles).  
Hohe Waschtischarmatur mit Schwenkauslauf, Ablaufgarnitur 1"1/4 (inkl. Anschlussschläuche).  
Bimando lavabo alto, caño orientable, desagüe automático 1"1/4 (con flex.).  
Смеситель для раковины с удлинением, поворотным изливом, с донным клапаном на 1"1/4 (с гибкими шлангами)

Articolo	Note	CROMO	CR	BR	O
S7256AH		303,00	333,00	423,00	545,00

7222

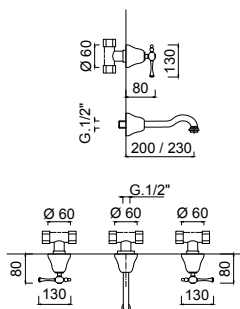

**Lavabo 3 fori a muro, bocca mm.200/230, senza scarico.**  
Wall-mounted 3-hole wash-basin set, spout mm 200/230, without pop-up waste.  
Mélangeur lavabo mural 3 trous, bec mm 200/230, sans vidage.  
3-Loch Waschtischarmatur für die Wandmontage, Auslauf mm 200/230, ohne Ablaufgarnitur.  
Bimando lavabo mural 3 agujeros, caño mm 200/230, sin desagüe automático.  
Комплект для раковины на 3 отверстия настенного монтажа, излив 200/230 мм., без донного клапана

Articolo	Note	CROMO	CR	BR	O
7222		199,00	218,00	278,00	358,00

7223

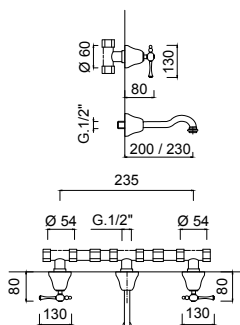

**Lavabo 3 fori a muro, bocca mm.200/230, senza scarico (con connessioni).**  
Wall-mounted 3-hole wash-basin set, spout mm 200/230, without pop-up waste (with connections).  
Mélangeur lavabo mural 3 trous, bec mm 200/230, sans vidage (avec les contacteurs).  
3-Loch Waschtischarmatur für die Wandmontage, Auslauf mm 200/230, ohne Ablaufgarnitur. (mit Verbindungen).  
Bimando lavabo mural 3 agujeros, caño mm 200/230, sin desagüe automático. (con conexiones).  
Комплект для раковины на 3 отверстия настенного монтажа, излив 200/230 мм., без донного клапана (с соединениями)

Articolo	Note	CROMO	CR	BR	O
7223		244,00	268,00	341,00	439,00

**7213A**

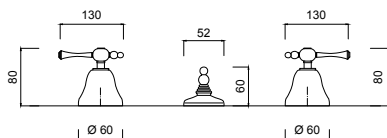

**Batteria bidet 3 fori, scarico 1"1/4.**  
3-hole bidet set, 1"1/4 pop-up waste.  
Mélangeur bidet 3 trous, vidage 1"1/4 (avec flexibles).  
3-Loch Bidetarmatur, Ablaufgarnitur 1"1/4.  
Grifo de bidé 3 agujeros, desagüe automático 1"1/4.  
Комплект для биде на 3 отверстия, донный клапан 1"1/4

Articolo	Note	CROMO	CR	BR	O
<b>7213A</b>		182,00	200,00	263,00	327,00

**7245A**

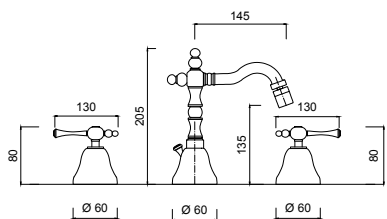

**Batteria bidet 3 fori, bocca girevole, scarico 1"1/4**  
3-hole bidet set, swivel spout, 1"1/4 pop-up waste.  
Mélangeur bidet à 3 trous, bec mobile, vidage automatique 1"1/4.  
Bidet-Dreilochbatterie, Rohrauslauf, Ablaufgarnitur 1"1/4.  
Batería bidet, caño giratorio, tarón accionado por varilla 1"1/4.  
Комплект для биде на 3 отверстия, поворотный излив, донный клапан 1"1/4 (гибкая подводка).

Articolo	Note	CROMO	CR	BR	O
<b>7245A</b>		293,00	322,00	424,00	527,00

**S7258A**

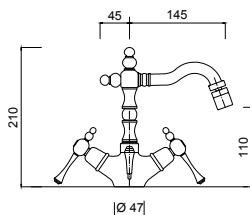
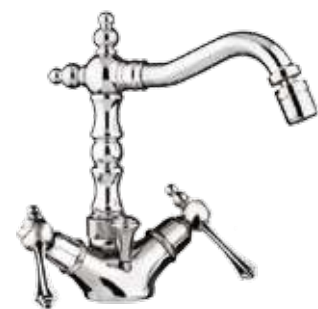

**Monoforo bidet, bocca girevole, scarico 1"1/4 (con flessibile)**  
Bidet unit, swivel spout, 1"1/4 pop-up waste (with flexible).  
Mélangeur monotrou bidet, bec mobile, vidage automatique 1"1/4 (avec flex.).  
Bidet-Einlochbatterie, Rohrauslauf, Ablaufgarnitur 1"1/4 (mit flexiblen Anschlussschläuchen).  
Monobloque bidet, caño giratorio, tarón accionado por varilla 1"1/4 (con flexible).  
Смеситель для биде, поворотный излив, донный клапан 1"1/4 (гибкая подводка).

Articolo	Note	CROMO	CR	BR	O
<b>S7258A</b>		210,00	231,00	293,00	378,00

**SA7264**

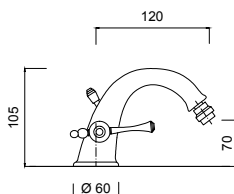

**Monoforo bidet, scarico 1"1/4 (con flessibile).**  
Bidet set, 1"1/4 pop-up waste (with flexibles).  
Mélangeur bidet monotrou, vidage 1"1/4 (avec flexibles).  
Bidetarmatur, Ablaufgarnitur 1"1/4 (inkl. Anschlussschläuche).  
Bimando bidé, desagüe automático 1"1/4 (con flex.).  
Комплект для биде, донный клапан 1"1/4 (с гибкими шлангами)

Articolo	Note	CROMO	CR	BR	O
<b>SA7264</b>		210,00	231,00	293,00	378,00

**7235**

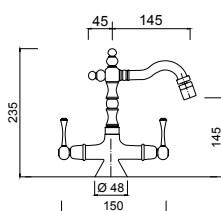

**Monoforo bidet, bocca girevole, senza scarico (con flessibile).**  
Bidet set, swivel spout, without pop-up waste (with flexibles).  
Mitigeur bidet monotrou, bec orientable, sans vidage (avec flexibles).  
Bidetarmatur mit Schwenkauslauf, ohne Ablaufgarnitur (inkl. Anschlussschläuche).  
Bimando bidé, caño orientable, sin desagüe automático (con flex.).  
Комплект для биде, поворотный излив, без донного клапана (с гибкими шлангами)

Articolo	Note	CROMO	CR	BR	O
<b>7235</b>		219,00	240,00	317,00	394,00

7235P

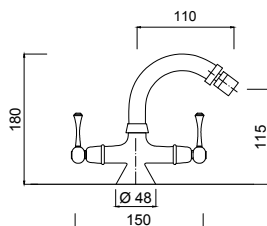

**Monoforo bidet, bocca girevole, senza scarico (con flessibile).**  
Bidet set, swivel spout, without pop-up waste (with flexibles).  
Mitigeur bidet monotrou, bec orientable, sans vidage (avec flexibles).  
Bidetarmatur mit Schwenkauslauf, ohne Ablaufgarnitur (inkl. Anschlussschläuche).  
Bimando bidé, caño orientable, sin desagüe automático (con flex.).  
Комплект для биде, поворотный излив, без донного клапана (с гибкими шлангами)

Articolo	Note	CROMO	CR	BR	O
7235P		164,00	180,00	237,00	295,00

7216W2KB

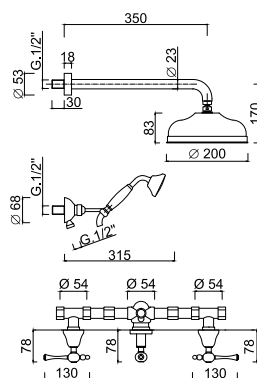
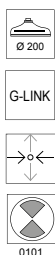

**Set doccia incasso con deviatore 2 vie, soffione ottone , kit duplex incasso.**  
Built-in shower set with 2-way diverter, brass showerhead , duplex shower kit.  
Mélangeur douche à encastrer avec inverseur à 2 sorties, pomme de douche en laiton , ensemble de douche.  
UP-Brausearmatur mit 2-Wege-Umstellung, Kopfbrause aus Messing , UP-Brauseset.  
Termostática ducha empotrada con inversor 2 vías, rociador en latón , kit de ducha empotrado.  
Встраиваемый комплект для душа с дивертером на 2 выхода, верхний душ из латуни 250 мм, душевой набор "duplex"

Articolo	Note	CROMO	CR	BR	O
7216W2KB		666,00	733,00	908,00	1.147,00

7216W2

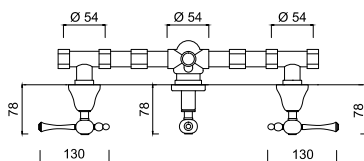
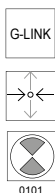

**Rubinetto incasso doccia e deviatore 2 uscite.**  
Concealed shower taps and 2 outlets diverter.  
Mélangeur douche encastré et inverseur 2 sorties.  
Unterputz-Brausebatterie mit 2-Ausgänge Umstellung.  
Grupo ducha empotrar y desviador 2 salidas.  
Встроенные краны для душа и дивертер на 2 выхода

Articolo	Note	CROMO	CR	BR	O
7216W2		293,00	322,00	408,00	527,00

7216W3

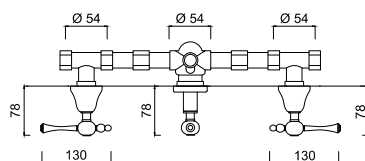
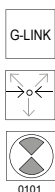

**Rubinetto incasso doccia e deviatore 3 uscite.**  
Concealed shower taps and 3 outlets diverter.  
Mélangeur douche encastré et inverseur 3 sorties.  
Unterputz-Brausebatterie mit 3-Ausgänge Umstellung.  
Grupo ducha empotrar y desviador 3 salidas.  
Встроенные краны для душа и дивертер на 3 выхода

Articolo	Note	CROMO	CR	BR	O
7216W3		323,00	355,00	468,00	581,00



### 8212-LN

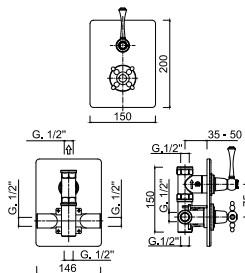

T<sub>38°</sub>

**Termostatico incasso 1/2", con rubinetto d'arresto 1/2".**  
Built-in thermostatic mixer 1/2", with built-in tap 1/2".  
Mitigeur thermostatique mural, 1/2", avec robinet mural 1/2".  
Eingebaute Einhebel Thermostatbatterie 1/2", mit Ventil 1/2".  
Mezclador termostatico a empotrar 1/2", con grifo 1/2".  
Встраиваемый термостат 1/2" со встраиваемым смесителем 3/4".

Articolo	Note	CROMO	CR	BR	O
8212-LN		470,00	528,00	657,00	750,00

### 8213-LN

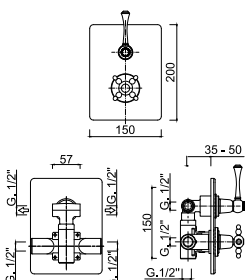

T<sub>38°</sub>

**Termostatico incasso 2 uscite**  
2 outlets built-in thermostatic mixer  
Mitigeur thermostatique mural à 2 sorties  
2-Ausgänge eingebaute Einhebel-Thermostatbatterie  
Mezclador termostatico a empotrar a 2 salidas.  
Встроенный термостатический смеситель на 2 выхода

Articolo	Note	CROMO	CR	BR	O
8213-LN		520,00	583,00	727,00	830,00

### 8282-LN

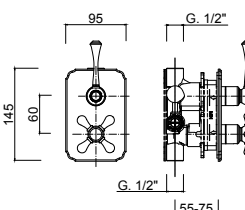

G-BOX  
T<sub>38°</sub>

**Termostatico incasso 2 uscite, box incasso.**  
Built-in thermostatic mixer with 2 outlets, built-in box.  
Mitigeur thermostatique douche à encastrer avec 2 sorties, box d'encastrement.  
UP-Thermostat mit 2-Wege-Umstellung, inkl. Box.  
Termostática empotrada 2 salidas, box empotrado incluido.  
Встраиваемый термостатический смеситель с 2 выходами, встраиваемый бокс

Articolo	Note	CROMO	CR	BR	O
8282-LN		840,00	882,00	1.092,00	1.260,00

### 8283-LN

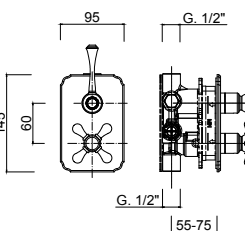

G-BOX  
T<sub>38°</sub>

**Termostatico incasso 3 uscite, box incasso.**  
Built-in thermostatic mixer with 3 outlets, built-in box.  
Mitigeur thermostatique douche à encastrer avec 3 sorties, box d'encastrement.  
UP-Thermostat mit 3-Wege-Umstellung, inkl. Box.  
Termostática empotrada 3 salidas, box empotrado incluido.  
Встраиваемый термостатический смеситель с 3 выходами, встраиваемый бокс

Articolo	Note	CROMO	CR	BR	O
8283-LN		890,00	934,00	1.157,00	1.335,00

### 1714-20

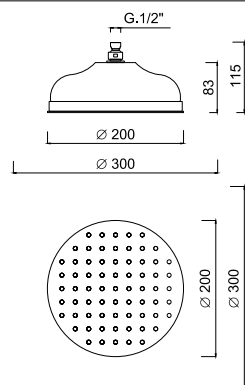

**Soffione doccia Ø 200.**  
200 mm diameter shower head.  
Pomme de douche Ø 200 mm.  
Kopfbrause, Ø 200 mm.  
Alcachofa Ø 200 mm.  
Душевая лейка с защитой от известняка Ø 200.

Articolo	Note	CROMO	CR	BR	O
1714-20	mm 200	171,00	•	205,00	229,00
1714-30	mm 300	335,00	•	364,00	420,00

1751-35

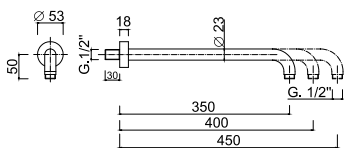

**Braccio doccia in ottone da mm 350.**  
Brass shower arm, length mm 350.  
Bras de douche, laiton chromé, longueur mm 350.  
Wandarm, mm 350 Länge, verchromtes Messing.  
Brazo ducha largo 350 mm, latón cromado.  
Душевой кронштейн из латуни, длина 350 мм.

Articolo	Note	CROMO	CR	BR	O
1751-35	mm 350	78,00	•	121,00	150,00
1751-40	mm 400	83,00	•	•	•
1751-45	mm 450	98,00	•	•	•

1757

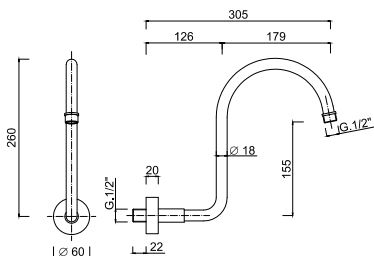

**Braccio doccia in ottone.**  
Brass shower arm.  
Bras de douche en laiton.  
Wandarm aus Messing.  
Brazo de ducha a pared en latón.  
Держатель для душа из латуни

Articolo	Note	CROMO	CR	BR	O
1757		98,00	•	135,00	163,00

1762-10

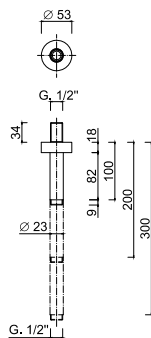

**Braccio doccia da soffitto mm.100.**  
Ceiling shower arm mm 100.  
Bras de douche vertical mm 100.  
Brausearm für Deckenmontage mm 100.  
Brazo de ducha a techo mm 100.  
Держатель душа 100 мм, потолочный

Articolo	Note	CROMO	CR	BR	O
1762-10	mm 100	52,00	•	78,00	102,00
1762-20	mm 200	61,00	•	•	•
1762-30	mm 300	70,00	•	•	•

1550

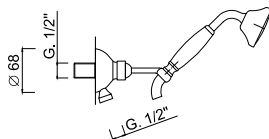

**Kit duplex incasso Londra.**  
Built-in duplex shower kit Londra.  
Ensemble de douche duplex à encaissement Londra.  
Einbaubrauseset Duplex Londra.  
Conjunto de ducha duplex para empotrar Londra.  
встроенный душевой набор "Duplex" Londra.

Articolo	Note	CROMO	CR	BR	O
1550		124,00	136,00	180,00	258,00



**7207WS**

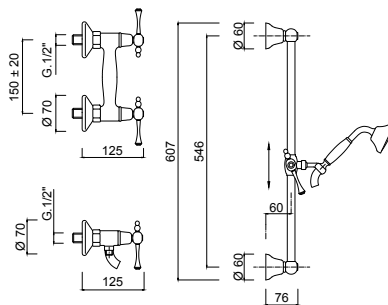

**Gruppo doccia esterno con saliscendi e doccia**

External shower mixer with sliding rail set.  
mitigeur extérieur de douche avec barre coulissante et ensemble de douche.  
Aufputz-Brausebatterie mit Brausestange und Brauseset.  
Grupo ducha externo con conjunto ducha.  
Смеситель для душа внешнего монтажа с комплектом штанги для душа.

Articolo	Note	CROMO	CR	BR	O
<b>7207WS</b>		371,00	408,00	525,00	668,00

**7207WC-S**

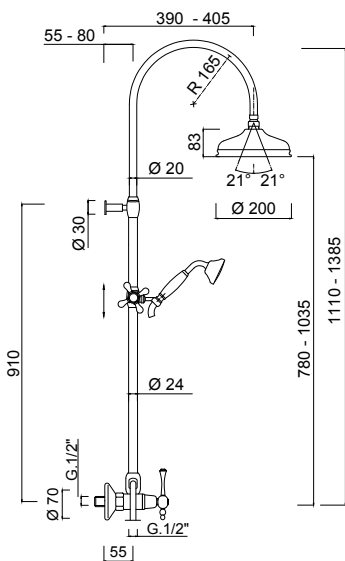

**Colonna doccia esterna, set doccia, soffione in ottone**

External shower column, shower kit, brass shower head.  
Colonne de douche extérieure, ensemble de douche, pomme de douche en laiton.  
Aufputz-Standbrause, Brauseset, Kopfbrause in Messing.  
Columna ducha externa, conjunto de ducha, rociador en latón.  
Душевая колонна внешнего монтажа, душевой набор, верхний душ из латуни

Articolo	Note	CROMO	CR	BR	O
<b>7207WC-S</b>		835,00	918,00	1.061,00	1.205,00

**8209-LNWC-S**

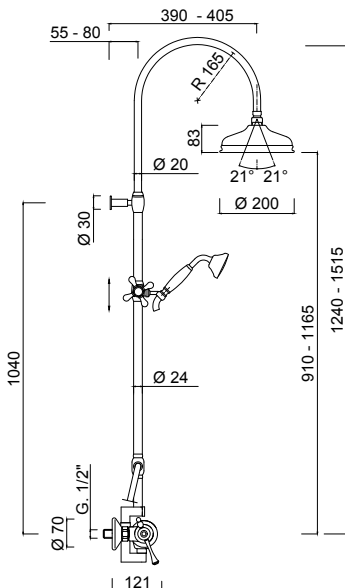

**Colonna doccia esterna termostatica, set doccia, soffione in ottone**

External thermostatic shower column, shower kit, brass shower head  
Colonne de douche avec mélangeur thermostatique, ensemble de douche, pomme de douche en laiton  
Aufputz- Standbrause mit Thermostat-Brausebatterie, Brauseset, Kopfbrause in Messing  
Columna ducha con mezclador termostático, conjunto de ducha, rociador ducha en latón  
Термостатическая душевая колонна внешнего монтажа, душевой набор, верхний душ из латуни

Articolo	Note	CROMO	CR	BR	O
<b>8209-LNWC-S</b>		1.321,00	1.453,00	1.691,00	1.918,00



7207

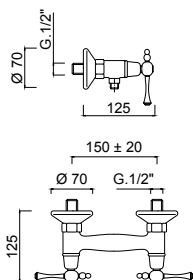

**Gruppo doccia esterno**

External shower mixer.  
Mitigeur extérieur de douche.  
Aufputz- Brausebatterie.  
Grupo ducha externo.  
Смеситель для душа внешнего монтажа

Articolo	Note	CROMO	CR	BR	O
7207		125,00	137,00	181,00	225,00

8209-LN

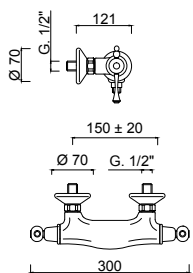

**Miscelatore termostatico doccia esterno.**

External shower thermostatic mixer.  
Mélangeur thermostatique pour douche.  
Thermostat-Brausebatterie.  
Mezclador termostático externo ducha.  
Термостатический смеситель для внешнего душа.

Articolo	Note	CROMO	CR	BR	O
8209-LN		433,00	476,00	588,00	720,00

7200WC-S

Vasca - Bath

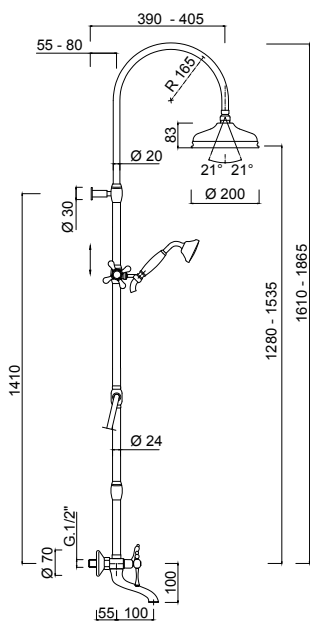

**Gruppo vasca esterno con colonna doccia, soffione ottone.**

Wall-mounted bath set with shower column and brass showerhead.  
Mélangeur bain-douche avec colonne de douche et pomme de douche en laiton.  
AP-Wannenbatterie mit Duschsäule, Kopfbrause aus Messing.  
Conjunto bañera de superficie, rociador en latón.  
Комплект для ванны настенного монтажа с душевой колонной и верхним душем из латуни

Articolo	Note	CROMO	CR	BR	O
7200WC-S		1.034,00	1.137,00	1.499,00	1.861,00

7201CB

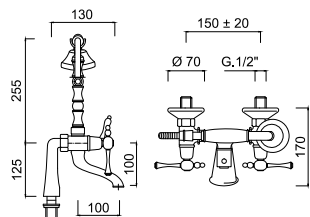

**Gruppo vasca esterno con set doccia, colonne bordo vasca.**

Wall-mounted bath set with shower kit, deck mounted tap legs.  
Mélangeur bain-douche avec ensemble de douche et colonnes sur gorge.  
AP-Wannenbatterie mit Brauseset, Standfüßen.  
Bimando bañera con kit de ducha, codos para batería de repisa.  
Комплект для ванны настенного монтажа с душевым набором, держатели для смесителя на край ванны

Articolo	Note	CROMO	CR	BR	O
7200CB		431,00	474,00	624,00	775,00

**7201CT**

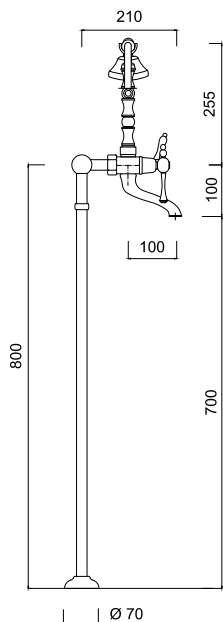

**Gruppo vasca esterno con doccia con colonne a pavimento.**  
External bathtub set with floor pillar legs, flexible hose and hand shower.  
Mélangeur bain/douche avec colonnettes alimentation par le sol, flexible, douchette.  
Wannenbatterie mit Standfüssen, Schlauch und Handbrause.  
Grupo bañera externo con columnas a pavimento, flexible y ducha.  
Внешний смеситель для ванны на опорных ножках для напольной установки с душевой лейкой.

Articolo	Note	CROMO	CR	BR	O
<b>7200CT</b>		775,00	854,00	1.080,00	1.251,00

**7201**

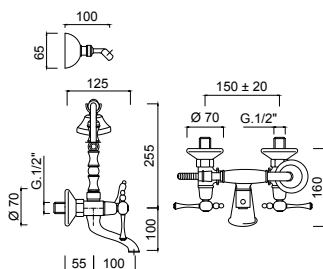

**Gruppo vasca esterno con set doccia duplex**  
External bathtub set with duplex shower kit.  
Mélangeur bain-douche extérieur avec ensemble de douche duplex.  
Wannenbatterie mit Schlauch-Handbrause und verstellbarem Wandhalter.  
Grupo bañera externo con conjunto de ducha duplex.  
Комплект для ванны внешнего монтажа с душевым набором "Duplex".

Articolo	Note	CROMO	CR	BR	O
<b>7201</b>		369,00	405,00	535,00	664,00

**7200**

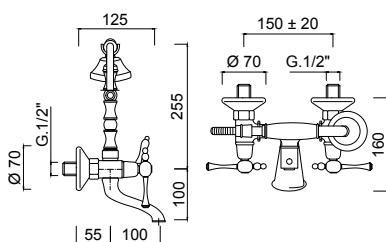

**Gruppo vasca esterno con doccia.**  
External bathtub set with shower.  
Mélangeur bain-douche extérieur avec douchette.  
Wannenbatterie mit Schlauch-Handbrause nu verstellbarem.  
Grupo bañera externo con ducha.  
Внешний смеситель для ванны с душевой лейкой

Articolo	Note	CROMO	CR	BR	O
<b>7200</b>		345,00	379,00	464,00	621,00

**7260**

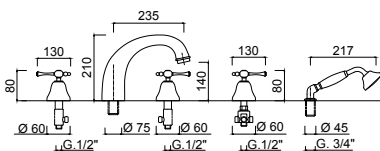

**Batteria bordo vasca 5 fori**  
5-hole bath border set.  
Groupe mitigeur à 5 trous bord baignoire.  
5-Loch Wannen Kombination.  
Bateria borde bañera 5 agujeros.  
Комплект на борт ванны на 5 отверстий.

Articolo	Note	CROMO	CR	BR	O
<b>7260</b>		630,00	693,00	913,00	1.134,00

7265

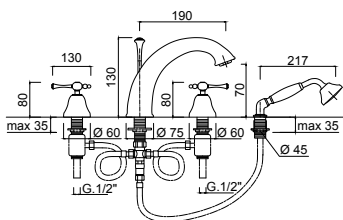

**Batteria bordo vasca 4 fori**

4-hole bath border set.  
Groupe mitigeur à 4 trous bord baignoire.  
4-Loch Wannen Kombination.  
Bateria borde bañera 4 agujeros.  
Комплект на борт ванны на 4 отверстий.

Articolo	Note	CROMO	CR	BR	O
7265		560,00	616,00	812,00	1.008,00

7216

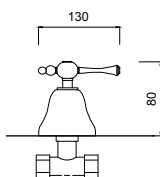

**Rubinetto incasso 1/2".**

1/2" built-in tap.  
Robinet à encaissement 1/2".  
UP-Ventil 1/2".  
Grifo para empotrar 1/2".  
Вентиль встроенный 1/2".

Articolo	Note	CROMO	CR	BR	O
7216		67,00	73,00	97,00	120,00

5009

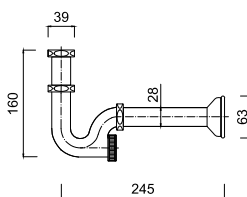

**Sifone per Lavabo 1"1/4.**

Trap for basin 1"1/4 .  
Siphon lavabo 1"1/4.  
Messing Rohrsiphon 1"1/4 für Waschtisch  
Sifón para lavabo 1"1/4.  
Сифон для раковины 1"1/4

Articolo	Note	CROMO	CR	BR	O
5009		40,00	•	75,00	116,00

5009B

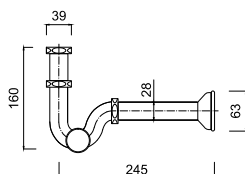

**Sifone per bidet 1"1/4.**

Brass basin trap 1"1/4.  
Siphon bidet laiton 1"1/4.  
Messing Rohrsiphon 1"1/4 für Bidet  
Sifón bidet en laiton 1"1/4.  
Сифон для умывальника из латуни 1"1/4.

Articolo	Note	CROMO	CR	BR	O
5009B		40,00	•	75,00	116,00

5011

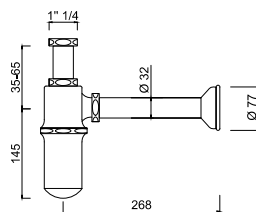

**Sifone 1" 1/4 a bottiglia.**

Bottle trap for basin 1" 1/4.  
Siphon bouteille pour lavabo 1"1/4.  
Tassensiphon 1" 1/4 für Waschtisch.  
Sifón botella para lavabo 1"1/4.  
Сифон бутылка 1" 1/4.

Articolo	Note	CROMO	CR	BR	O
5011		40,00	•	75,00	116,00

3063

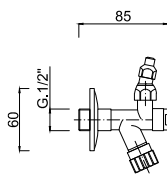

**Rubinetto con filtro con snodo.**  
*Tap with filter with articulated joint.*  
*Robinet d'arrêt avec filtre et coude*  
*Eckventil mit Filter*  
*Llave de regulaciòn con filtro*  
*Смеситель с фильтром и шарниром*

Articolo	Note	CROMO	CR	BR	O
3063		21,50	•	48,00	71,50

3262

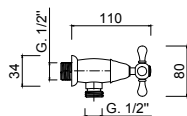

**Rubinetto sottolavabo.**  
*Angle valve.*  
*Robinet d'arrêt sous lavabo.*  
*Eckventil.*  
*Llave de paso.*  
*Вентиль под раковину*

Articolo	Note	CROMO	CR	BR	O
3262		52,00	•	70,00	90,00

1585

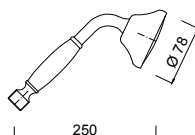

**Doccetta manopola ottone Londra.**  
*Londra hand-shower brass handle.*  
*Douchette avec poignée en laiton Londra.*  
*Londra Handbrause mit Griff aus Messing.*  
*Ducha de teléfono empuñadura latón Londra.*  
*Душевая лейка с ручкой из латуни Londra.*

Articolo	Note	CROMO	CR	BR	O
1585		61,00	67,00	73,00	95,00

LN1597

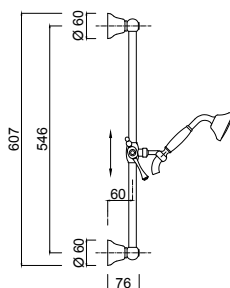

**Saliscendi maniglia Parigi con doccia Londra.**  
*Sliding bar with flexible hose and Londra handshower.*  
*Barre de douche avec flexible et douchette Londra.*  
*Brausegarnitur mit Wandstange Londra.*  
*Barre deslizante cob flexible y ducha Londra.*  
*Душевая стойка Parigi с ручкой Londra.*

Articolo	Note	CROMO	CR	BR	O
LN1597		242,00	270,00	340,00	438,00

1510

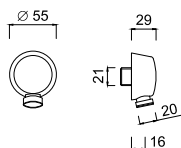

**Presca acqua 1/2".**  
Water plug 1/2".  
Prise d'eau mural 1/2".  
Wandanschlussbogen 1/2" für Brauseanschl.  
Toma de agua 1/2".  
Крепление к стене для гибкого шланга

Articolo	Note	CROMO	CR	BR	O
1510		16,00	•	24,00	33,00

0128



**Tubetto Ø 10 cm 35 con cartella e calotta.**  
Ø 10 cm 35 connection pipe with casing and cap.  
Tuyans Ø 10 cm 35 avec bordure.  
Gebogene Schläuche Ø 10 cm 35 mit Rand.  
Tubito Ø 10 cm 35 con revestimiento y casquete.  
Трубка Ø 10 см 35 с креплением и колпаком

Articolo	Note	CROMO	CR	BR	O
0128		7,20	•	13,00	18,00

**NOTE**

**Potete trovare altre soluzioni per la Doccia nell'area WELLNESS.** p.374  
For additional Shower options please go to WELLNESS section.  
Pour plus de solutions pour la Douche visitez la section WELLNESS.  
Für weitere Duschalternativen sehen Sie bitte in dem Kapitel WELLNESS nach.  
Para más soluciones para Ducha visite la sección WELLNESS.  
Другие решения для Душа вы найдете в разделе Wellness.

**Per gli Accessori Bagno abbinati alla serie potete consultare la serie LILIUM.** p.466  
For matching Bathroom Fittings please check LILIUM line.  
Pour les Accessoires Salle de Bains coordonnés à la collection visitez la ligne LILIUM.  
Die zu der Serie passenden Bad-Accessoires finden Sie in dem Linie LILIUM.  
Para los Accesorios de Baño compatibles con la serie visite la línea LILIUM.  
Чтобы подобрать подходящие аксессуары для ванной комнаты, перейдите в Линия LILIUM

A modern, minimalist interior scene. A white, curved table is in the foreground, partially obscuring a white wall. The wall has a subtle texture and a small, faint mark near the top left. The lighting is soft and even, creating a clean and contemporary atmosphere. The text 'G5' is overlaid on the wall in a bold, sans-serif font.

**G5**





**7912A**

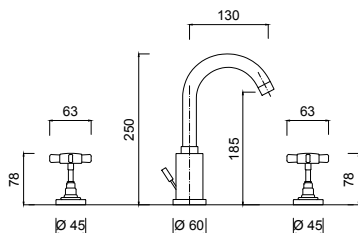

**Batteria lavabo 3 fori, bocca girevole, scarico 1"1/4**  
3-hole wash-basin set, swivel spout, 1"1/4 pop-up waste.  
Mélangeur lavabo à trois trous, bec mobile, vidage automatique 1"1/4.  
Waschtisch-Dreilochbatterie, Rohrauslauf, Ablaufgarnitur 1"1/4.  
Batería lavabo con 3 agujeros, caño giratorio, tapón accionado por varilla 1"1/4.  
Комплект для раковины на 3 отверстия, поворотный излив, донный клапан 1"1/4

Articolo	Note	CROMO	AR	O
7912A		277,00	401,00	498,00

**7957A**

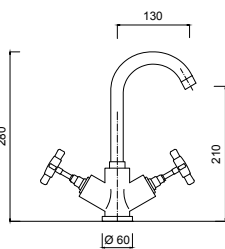

**Monoforo lavabo, bocca girevole, scarico 1"1/4 (con flessibile).**  
Wash-basin unit, swivel spout, 1"1/4 pop-up waste (with flexible).  
Mélangeur monotrou lavabo, bec mobile, vidage automatique 1"1/4 (avec flex.)  
Waschtisch-Einlochbatterie, Rohrauslauf, Ablaufgarnitur 1"1/4 (mit flexiblen Anschlussschläuchen).  
Monobloque lavabo, caño giratorio, tapón accionado por varilla 1"1/4 (con flexible).  
Смеситель для раковины, поворотный излив, донный клапан 1"1/4 (гибкая подводка).

Articolo	Note	CROMO	AR	O
7957A		242,00	350,00	435,00

**7920-25**

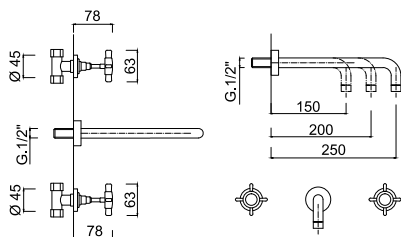

**Lavabo 3 fori a muro, bocca mm.200, senza scarico.**  
Wall-mounted 3-hole wash-basin set, spout mm 200, without pop-up waste.  
Mélangeur lavabo mural 3 trous, bec mm 200, sans vidage.  
3-Loch Waschtischarmatur für die Wandmontage, Auslauf mm 200, ohne Ablaufgarnitur.  
Bimando lavabo mural 3 agujeros, caño mm 200, sin desagüe automatico.  
Комплект для раковины на 3 отверстия настенного монтажа, излив 200 мм., без донного клапана

Articolo	Note	CROMO	AR	O
7920-25	mm 250	236,00	342,00	424,00
7920-20	mm 200	236,00	342,00	424,00
7920-15	mm 150	236,00	342,00	424,00

**7923-25**

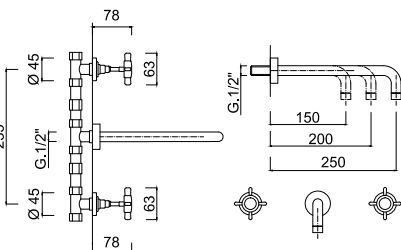

**Lavabo 3 fori a muro, bocca mm.200, senza scarico (con connessioni).**  
Wall-mounted 3-hole wash-basin set, spout mm 200, without pop-up waste (with connections).  
Mélangeur lavabo mural 3 trous, bec mm 200, sans vidage (avec les contacteurs).  
3-Loch Waschtischarmatur für die Wandmontage, Auslauf mm 200, ohne Ablaufgarnitur. (mit Verbindungen).  
Bimando lavabo mural 3 agujeros, caño mm 200, sin desagüe automatico. (con conexiones).  
Комплект для раковины на 3 отверстия настенного монтажа, излив 200 мм., без донного клапана (с соединениями)

Articolo	Note	CROMO	AR	O
7923-25	mm 250	253,00	366,00	455,00
7923-20	mm 200	253,00	366,00	455,00
7923-15	mm 150	253,00	366,00	455,00

**7913A**



**Batteria bidet 3 fori, scarico 1"1/4**  
3-hole bidet set, 1"1/4 pop-up waste.  
Mélangeur bidet à 3 trous, vidage automatique 1"1/4.  
Bidet-Dreilochbatterie, Ablaufgarnitur 1"1/4.  
Batería bidet, tapón accionado por varilla 1"1/4.  
Комплект для биде на 3 отверстия, донный клапан 1"1/4 (гибкая подводка).

Articolo	Note	CROMO	AR	O
7913A		171,00	247,00	307,00

**7945A**

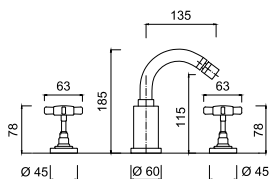

**Batteria bidet 3 fori, bocca girevole, scarico 1"1/4**

3-hole bidet set, swivel spout, 1"1/4 pop-up waste.  
Mélangeur bidet à 3 trous, bec mobile, vidage automatique 1"1/4.  
Bidet-Dreilochbatterie, Rohrauslauf, Ablaufgarnitur 1"1/4.  
Bateria bidet, caño giratorio, tapón accionado por varilla 1"1/4.  
Комплект для биде на 3 отверстия, поворотный излив, донный клапан 1"1/4 (гибкая подводка).

Articolo	Note	CROMO	AR	O
<b>7945A</b>		275,00	398,00	495,00

**7959A**

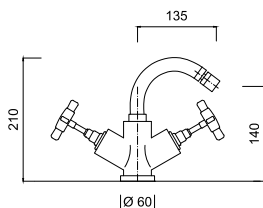

**Monoforo bidet, bocca girevole, scarico 1"1/4 (con flessibile)**

Bidet unit, swivel spout, 1"1/4 pop-up waste (with flexible).  
Mélangeur monotrou bidet, bec mobile, vidage automatique 1"1/4 (avec flex.)  
Bidet-Einlochbatterie, Rohrauslauf, Ablaufgarnitur 1"1/4 (mit flexiblen Anschlussschläuchen).  
Monobloque bidet, caño giratorio, tapón accionado por varilla 1"1/4 (con flexible).  
Смеситель для биде, поворотный излив, донный клапан 1"1/4 (гибкая подводка).

Articolo	Note	CROMO	AR	O
<b>7959A</b>		242,00	350,00	435,00

**7915W2KS**

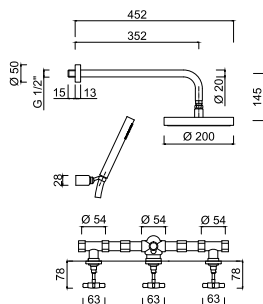

**Set doccia incasso con deviatore 2 vie, soffione ottone, kit duplex incasso**

Concealed shower taps with 2 ways diverter, brass shower head, built-in duplex shower kit  
Mélangeur douche encastré avec inverseur à 2 voies, pomme de douche en laiton, ensemble de douche duplex à encaissement  
Unterputz-Brausebatterie mit 2-Wage-Umstellung, Brausekopf in Messing, Einbau-Brausekit Duplex  
Grupo ducha empotrar con desviador 2 salidas, rociador ducha en latón, conjunto ducha duplex para empotrar  
Встроенные краны для душа с дивертером на 2 выхода, верхний душ из латуни, встроенный душевой набор "Duplex"

Articolo	Note	CROMO	AR	O
<b>7915W2KS</b>		594,00	861,00	1.069,00

**7915WB**

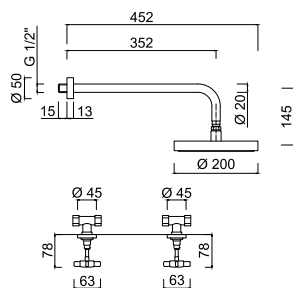

**Set doccia incasso, soffione in ottone**

Concealed shower tap, brass shower head.  
Mélangeur douche encastré, pomme de douche mural en laiton.  
Unterputz-Brausebatterie mit Kopfbrause in Messing.  
Grupo ducha empotrar con rociador en latón.  
Встроенные краны для душа, верхний душ из латуни.

Articolo	Note	CROMO	AR	O
<b>7915WB</b>		449,00	651,00	808,00

**7915W2**

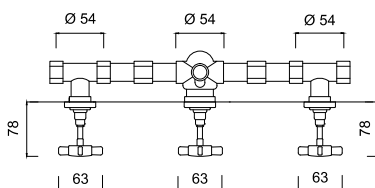
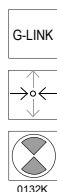
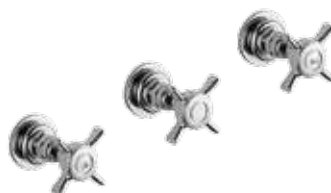

**Rubinetto incasso doccia e deviatore 2 uscite.**

Concealed shower taps and 2 outlets diverter.  
Mélangeur douche encastré et inverseur 2 sorties.  
Unterputz-Brausebatterie mit 2-Ausgänge Umstellung.  
Grupo ducha empotrar y desviador 2 salidas.  
Встроенные краны для душа и дивертер на 2 выхода

Articolo	Note	CROMO	AR	O
<b>7915W2</b>		264,00	382,00	475,00



7915

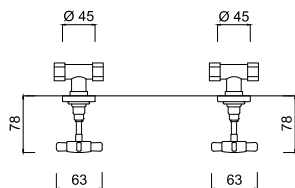

**Rubinetto incasso doccia**

Concealed shower taps.  
Mélangeur douche encastré.  
Unterputz-Brausebatterie.  
Grupo ducha empotrar.  
Встроенные краны для душа.

Articolo	Note	CROMO	AR	O
7915		125,00	181,00	225,00

7907WS

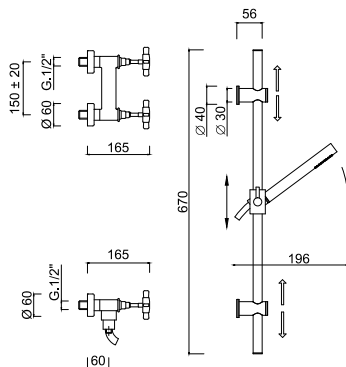

**Gruppo doccia esterno con saliscendi e doccia**

External shower mixer with sliding rail set.  
mitigeur extérieur de douche avec barre coulissante et ensemble de douche.  
Aufputz-Brausebatterie mit Brausestange und Brauseset.  
Grupo ducha externo con conjunto ducha.  
Смеситель для душа внешнего монтажа с комплектом штанги для душа.

Articolo	Note	CROMO	AR	O
7907WS		415,00	601,00	747,00

7907WC-S

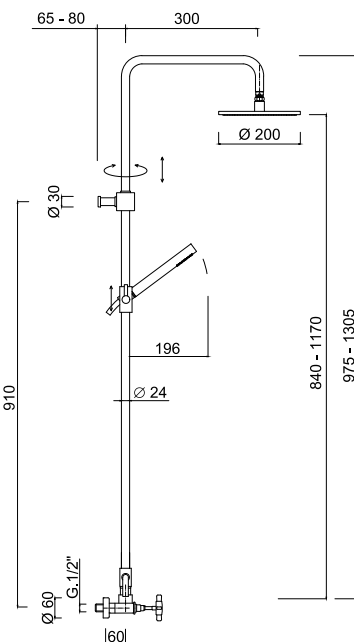

**Colonna doccia esterna, set doccia, soffione in ottone**

External shower column, shower kit, brass shower head.  
Colonne de douche extérieure, ensemble de douche, pomme de douche en laiton.  
Aufputz-Standbrause, Brauseset, Kopfbrause in Messing.  
Columna ducha externa, conjunto de ducha, rociador en latón.  
Душевая колонна внешнего монтажа, душевой набор, верхний душ из латуни

Articolo	Note	CROMO	AR	O
7907WC-S		750,00	1.087,00	1.350,00

7907

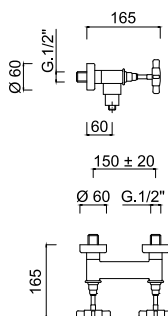

**Gruppo doccia esterno**

External shower mixer.  
Mitigeur extérieur de douche.  
Aufputz- Brausebatterie.  
Grupo ducha externo.  
Смеситель для душа внешнего монтажа

Articolo	Note	CROMO	AR	O
7907		212,00	307,00	381,00

7901

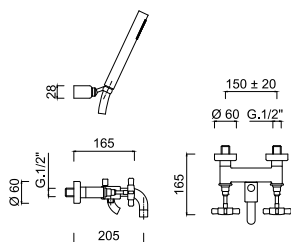

**Gruppo vasca esterno con set doccia duplex**

External bathtub set with duplex shower kit.  
Mélangeur bain-douche extérieur avec ensemble de douche duplex.  
Wannenbatterie mit Schlauch-Handbrause und verstellbarem Wandhalter.  
Grupo bañera externo con conjunto de ducha duplex.  
Комплект для ванны внешнего монтажа с душевым набором "Duplex".

Articolo	Note	CROMO	AR	O
7901		377,00	546,00	678,00

7960

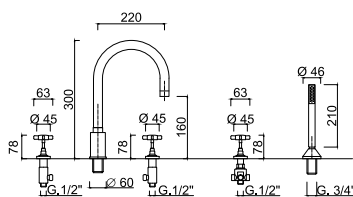

**Batteria bordo vasca 5 fori**

5-hole bath border set.  
Groupe mitigeur à 5 trous bord baignoire.  
5-Loch Wannen Kombination.  
Batería borde bañera 5 agujeros.  
Комплект на борт ванны на 5 отверстий.

Articolo	Note	CROMO	AR	O
7960		538,00	780,00	968,00

7965

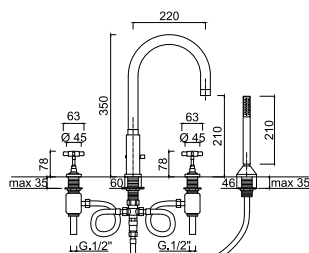

**Batteria bordo vasca 4 fori**

4-hole bath border set.  
Groupe mitigeur à 4 trous bord baignoire.  
4-Loch Wannen Kombination.  
Batería borde bañera 4 agujeros.  
Комплект на борт ванны на 4 отверстий.

Articolo	Note	CROMO	AR	O
7965		493,00	714,00	887,00

**NOTE**

**Potete trovare altre soluzioni per la Doccia nell'area WELLNESS.**

For additional Shower options please go to WELLNESS section.  
Pour plus de solutions pour la Douche visitez la section WELLNESS.  
Für weitere Duschalternativen sehen Sie bitte in dem Kapitel WELLNESS nach.  
Para más soluciones para Ducha visite la sección WELLNESS.  
Другие решения для Душа вы найдете в разделе Wellness.

p.374

**Per gli Accessori Bagno abbinati alla serie potete consultare la serie MODERNA.**

For matching Bathroom Fittings please check MODERNA line.  
Pour les Accessoires Salle de Bains coordonnés à la collection visitez la ligne MODERNA.  
Die zu der Serie passenden Bad-Accessoires finden Sie in dem Linie MODERNA.  
Para los Accesorios de Baño compatibles con la serie visite la línea MODERNA.  
Чтобы подобрать подходящие аксессуары для ванной комнаты, перейдите в Линия MODERNA.

p.446



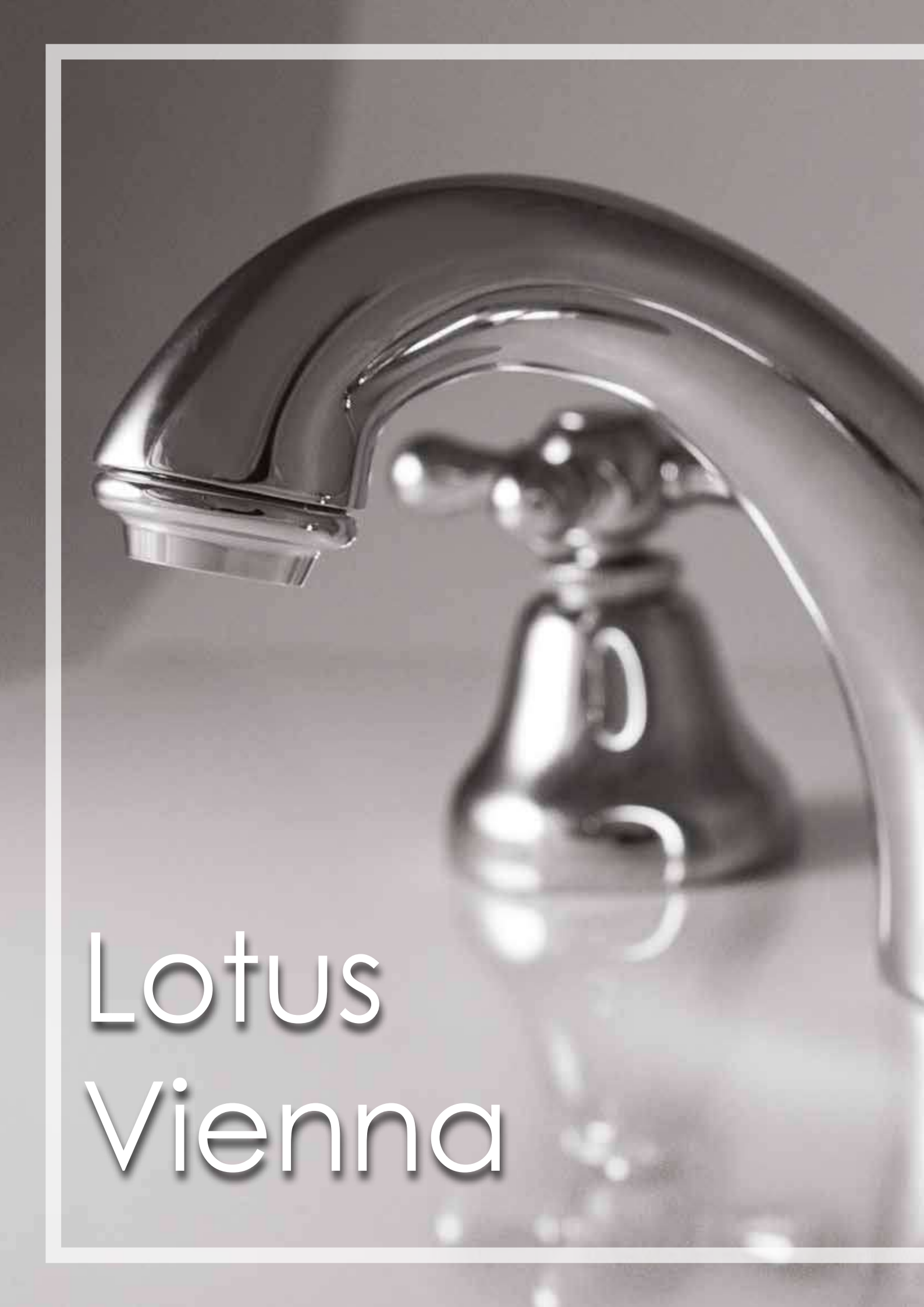

Lotus  
Vienna





**A512**

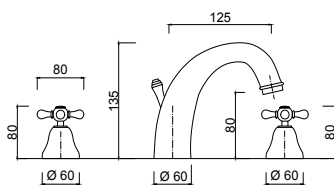

**Batteria lavabo 3 fori, scarico 1"1/4**

3-hole wash-basin set, luxury 1"1/4 pop-up waste.  
Mélangeur lavabo à trois trous, vidage automatique 1"1/4 deluxe.  
Waschtisch-Dreilochbatterie, Ablaufgarnitur 1"1/4 luxus.  
Batería lavabo con 3 agujeros, tapón accionado por varilla 1"1/4 lujo.  
Комплект для раковины на 3 отверстия, донный клапан 1"1/4

Articolo	Note	CROMO	CR-C	CO-BR	O
A512		220,00	253,00	308,00	385,00
A7012	VI	227,00	260,00	315,00	392,00
A7112	LVC	229,00	262,00	317,00	394,00

**A506**

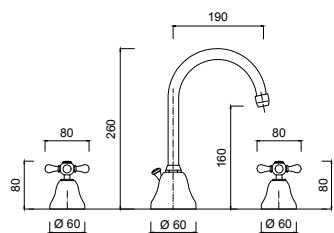

**Batteria lavabo 3 fori, bocca girevole, scarico 1"1/4**

3-hole wash-basin set, swivel spout, 1"1/4 pop-up waste.  
Mélangeur lavabo à trois trous, bec mobile, vidage automatique 1"1/4.  
Waschtisch-Dreilochbatterie, Rohrauslauf, Ablaufgarnitur 1"1/4.  
Batería lavabo con 3 agujeros, caño giratorio, tapón accionado por varilla 1"1/4.  
Комплект для раковины на 3 отверстия, поворотный излив, донный клапан 1"1/4

Articolo	Note	CROMO	CR-C	CO-BR	O
A506		220,00	253,00	308,00	385,00
A7006	VI	227,00	260,00	315,00	392,00
A7106	LVC	229,00	262,00	317,00	394,00

**SA555**

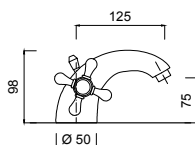
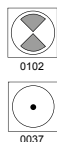

**Monoforo lavabo, scarico 1"1/4 (con flessibile).**

Wash-basin set, 1"1/4 pop-up waste (with flexibles).  
Mélangeur lavabo monotrou, vidage 1"1/4 (avec flexibles).  
Waschtischarmatur, Ablaufgarnitur 1"1/4 (inkl. Anschlussschläuche).  
Bimando lavabo, desagüe automático 1"1/4 (con flex.).  
Комплект для раковины, донный клапан 1"1/4 (с гибкими шлангами)

Articolo	Note	CROMO	CR-C	CO-BR	O
SA555		170,00	195,00	238,00	298,00
SA7055	VI	177,00	202,00	245,00	305,00
SA7155	LVC	179,00	204,00	247,00	307,00

**SA561**

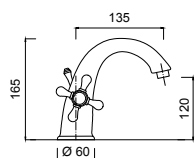

**Monoforo lavabo lusso, scarico 1"1/4 (con flessibile).**

Wash-basin set, 1"1/4 pop-up waste (with flexibles).  
Mélangeur lavabo monotrou, vidage 1"1/4 (avec flexibles).  
Waschtischarmatur, Ablaufgarnitur 1"1/4 (inkl. Anschlussschläuche).  
Bimando lavabo, desagüe automático 1"1/4 (con flex.).  
Комплект для раковины, донный клапан 1"1/4 (с гибкими шлангами)

Articolo	Note	CROMO	CR-C	CO-BR	O
SA561		199,00	229,00	279,00	348,00
SA7061	VI	206,00	236,00	286,00	355,00
SA7161	LVC	208,00	238,00	288,00	357,00

**SA556**

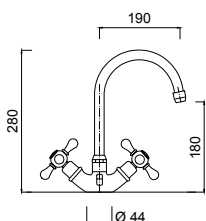

**Monoforo lavabo, bocca alta, scarico 1"1/4 (con flessibile).**

Wash-basin set, high spout, 1"1/4 pop-up waste (with flexibles).  
Mélangeur lavabo monotrou, bec haut, vidage 1"1/4 (avec flexibles).  
Waschtischarmatur mit hohem Auslauf, Ablaufgarnitur 1"1/4 (inkl. Anschlussschläuche).  
Bimando lavabo, caño alto, desagüe automático 1"1/4 (con flex.).  
Комплект для раковины, высокий излив, донный клапан на 1"1/4 (с гибкими шлангами)

Articolo	Note	CROMO	CR-C	CO-BR	O
SA556		160,00	184,00	224,00	280,00
SA7056	VI	167,00	191,00	231,00	287,00
SA7156	LVC	169,00	193,00	233,00	289,00

**0522**

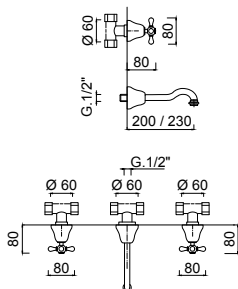

**Lavabo 3 fori a muro, bocca mm.200, senza scarico.**  
Wall-mounted 3-hole wash-basin set, spout mm 200, without pop-up waste.  
Mélangeur lavabo mural 3 trous, bec mm 200, sans vidage.  
3-Loch Waschtischarmatur für die Wandmontage, Auslauf mm 200, ohne Ablaufgarnitur.  
Bimando lavabo mural 3 agujeros, caño mm 200, sin desagüe automático.  
Комплект для раковины на 3 отверстия настенного монтажа, излив 200 мм., без донного клапана

Articolo	Note	CROMO	CR-C	CO-BR	O
0522		197,00	226,00	275,00	344,00
7022	VI	204,00	233,00	282,00	351,00
7122	LVC	206,00	235,00	284,00	353,00

**0523**

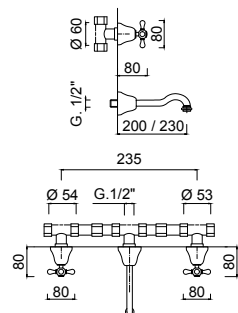

**Lavabo 3 fori a muro, bocca mm.200, senza scarico (con connessioni).**  
Wall-mounted 3-hole wash-basin set, spout mm 200, without pop-up waste (with connections).  
Mélangeur lavabo mural 3 trous, bec mm 200, sans vidage (avec les contacteurs).  
3-Loch Waschtischarmatur für die Wandmontage, Auslauf mm 200, ohne Ablaufgarnitur. (mit Verbindungen).  
Bimando lavabo mural 3 agujeros, caño mm 200, sin desagüe automático. (con conexiones).  
Комплект для раковины на 3 отверстия настенного монтажа, излив 200 мм., без донного клапана (с соединениями)

Articolo	Note	CROMO	CR-C	CO-BR	O
0523		242,00	278,00	338,00	423,00
7023	VI	249,00	285,00	345,00	430,00
7123	LVC	251,00	287,00	347,00	432,00

**A513**

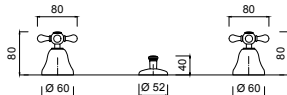

**Batteria bidet 3 fori, scarico 1"1/4.**  
3-hole bidet set, 1"1/4 pop-up waste.  
Mélangeur bidet 3 trous, vidage 1"1/4 (avec flexibles).  
3-Loch Bidetarmatur, Ablaufgarnitur 1"1/4.  
Grifo de bidé 3 agujeros, desagüe automático 1"1/4.  
Комплект для биде на 3 отверстия, донный клапан 1"1/4

Articolo	Note	CROMO	CR-C	CO-BR	O
A513		143,00	164,00	200,00	250,00
A7013	VI	150,00	171,00	207,00	257,00
A7113	LVC	152,00	173,00	209,00	259,00

**A545**

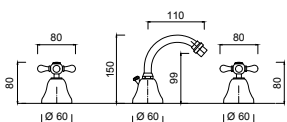

**Batteria bidet 3 fori, bocca girevole, scarico 1"1/4**  
3-hole bidet set, swivel spout, 1"1/4 pop-up waste.  
Mélangeur bidet à 3 trous, bec mobile, vidage automatique 1"1/4.  
Bidet-Dreilochbatterie, Rohrauslauf, Ablaufgarnitur 1"1/4.  
Bateria bidet, caño giratorio, tapón accionado por varilla 1"1/4.  
Комплект для биде на 3 отверстия, поворотный излив, донный клапан 1"1/4 (гибкая подводка).

Articolo	Note	CROMO	CR-C	CO-BR	O
A545		212,00	243,00	296,00	371,00
A7045	VI	219,00	250,00	303,00	378,00
A7145	LVC	221,00	252,00	305,00	380,00

**SA557**

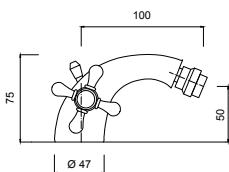

**Monoforo bidet, scarico 1"1/4 (con flessibile).**  
Bidet set, 1"1/4 pop-up waste (with flexibles).  
Mélangeur bidet monotrou, vidage 1"1/4 (avec flexibles).  
Bidetarmatur, Ablaufgarnitur 1"1/4 (inkl. Anschlussschläuche).  
Bimando bidé, desagüe automático 1"1/4 (con flex.).  
Комплект для биде, донный клапан 1"1/4 (с гибкими шлангами)

Articolo	Note	CROMO	CR-C	CO-BR	O
SA557		167,00	192,00	234,00	300,00
SA7057	VI	174,00	199,00	241,00	307,00
SA7157	LVC	176,00	201,00	243,00	309,00

**SA564**

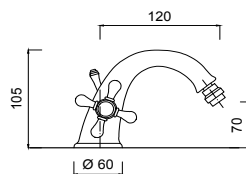

**Monoforo bidet lusso, scarico 1"1/4 (con flessibile).**  
Bidet set, 1"1/4 pop-up waste (with flexibles).  
Mélangeur bidet monotrou, vidage 1"1/4 (avec flexibles).  
Bidetarmatur, Ablaufgarnitur 1"1/4 (inkl. Anschlussschläuche).  
Bimando bidé, desagüe automatico 1"1/4 (con flex.).  
Комплект для биде, донный клапан 1"1/4 (с гибкими шлангами)

Articolo	Note	CROMO	CR-C	CO-BR	O
SA564		199,00	229,00	279,00	348,00
SA7064	VI	206,00	236,00	286,00	355,00
SA7164	LVC	208,00	238,00	288,00	357,00

**SA558**

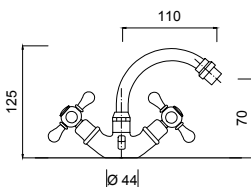

**Monoforo bidet, bocca alta, scarico 1"1/4 (con flessibile).**  
Bidet set, high spout, 1"1/4 pop-up waste (with flexibles).  
Mélangeur bidet monotrou, bec haut, vidage 1"1/4 (avec flexibles).  
Bidetarmatur mit hohem Auslauf, Ablaufgarnitur 1"1/4 (inkl. Anschlussschläuche).  
Bimando bidé, caño alto, desagüe automatico 1"1/4 (con flex.).  
Комплект для биде, высокий излив, донный клапан на 1"1/4 (с гибкими шлангами)

Articolo	Note	CROMO	CR-C	CO-BR	O
SA558		160,00	184,00	224,00	280,00
SA7058	VI	167,00	191,00	231,00	287,00
SA7158	LVC	169,00	193,00	233,00	289,00

**0515W2KS**

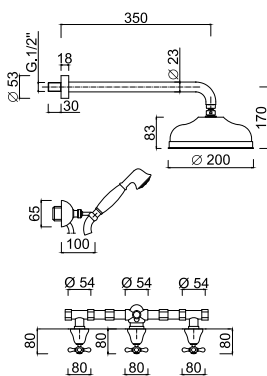
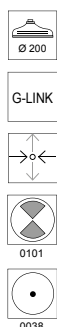

**Set doccia incasso con deviatore 2 vie, soffione ottone, kit duplex incasso**  
Concealed shower taps with 2 ways diverter, brass shower head, built-in duplex shower kit  
Mélangeur douche encastré avec inverseur à 2 voies, pomme de douche en laiton, ensemble de douche duplex à encaissement  
Unterputz-Brausebatterie mit 2-Wage-Umstellung, Brausekopf in Messing, Einbau-Brauseset Duplex  
Grupo ducha empotrar con desviador 2 salidas, rociador ducha en latón, conjunto ducha duplex para empotrar  
Встроенные краны для душа с дивертером на 2 выхода, верхний душ из латуни, встроенный душевой набор "Duplex"

Articolo	Note	CROMO	CR-C	CO-BR	O
0515W2KS		634,00	729,00	888,00	1.109,00
7015W2KS	VI	641,00	736,00	895,00	1.116,00
7115W2KS	LVC	643,00	738,00	897,00	1.118,00

**0515KB**

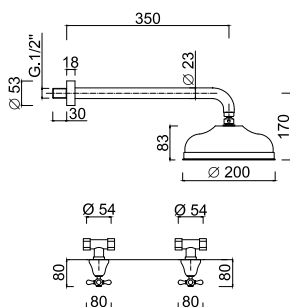

**Set doccia incasso, soffione in ottone**  
Concealed shower tap, brass shower head.  
Mélangeur douche encastré, pomme de douche mural en laiton.  
Unterputz-Brausebatterie mit Kopfbrause in Messing.  
Grupo ducha empotrar con rciador en latón.  
Встроенные краны для душа, верхний душ из латуни.

Articolo	Note	CROMO	CR-C	CO-BR	O
0515KB		161,00	185,00	225,00	281,00
7015KB	VI	168,00	192,00	232,00	288,00
7115KB	LVC	170,00	194,00	234,00	290,00

**0515W2**

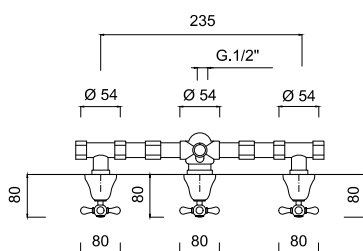

**Rubinetti incasso doccia e deviatore 2 uscite.**  
Concealed shower taps and 2 outlets diverter.  
Mélangeur douche encastré et inverseur 2 sorties.  
Unterputz-Brausebatterie mit 2-Ausgänge Umstellung.  
Grupo ducha empotrar y desviador 2 salidas.  
Встроенные краны для душа и дивертер на 2 выхода

Articolo	Note	CROMO	CR-C	CO-BR	O
0515W2		281,00	323,00	393,00	491,00
7015W2	VI	288,00	330,00	400,00	498,00
7115W2	LVC	290,00	332,00	402,00	500,00



0515

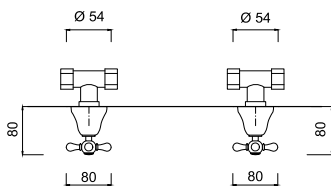

**Rubinetti incasso doccia**

Concealed shower taps.  
Mélangeur douche encastré.  
Unterputz-Brausebatterie.  
Grupo ducha empotrar.  
Встроенные краны для душа.

Articolo	Note	CROMO	CR-C	CO-BR	O
0515		112,00	128,00	156,00	196,00
7015	VI	119,00	135,00	163,00	203,00
7115	LVC	121,00	137,00	165,00	205,00

0507WS

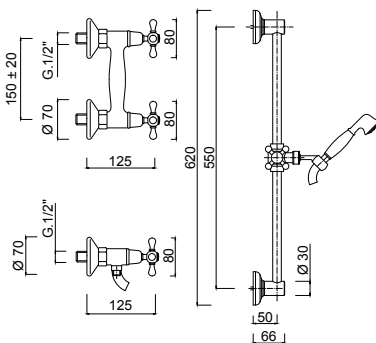
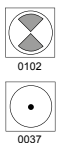

**Gruppo doccia esterno con saliscendi e doccia**

External shower mixer with sliding rail set.  
mitigeur extérieur de douche avec barre coulissante et ensemble de douche.  
Aufputz-Brausebatterie mit Brausestange und Brauseset.  
Grupo ducha externo con conjunto ducha.  
Смеситель для душа внешнего монтажа с комплектом штанги для душа.

Articolo	Note	CROMO	CR-C	CO-BR	O
0507WS		260,00	299,00	364,00	455,00
7007WS	VI	267,00	306,00	371,00	462,00
7107WS	LVC	269,00	308,00	373,00	464,00

0507WC-S

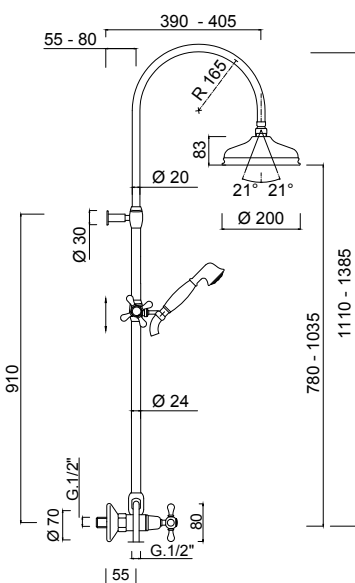

**Colonna doccia esterna, set doccia, soffione in ottone**

External shower column, shower kit, brass shower head.  
Colonne de douche extérieure, ensemble de douche, pomme de douche en laiton.  
Aufputz-Standbrause, Brauseset, Kopfbrause in Messing.  
Columna ducha externa, conjunto de ducha, rociador en latón.  
Душевая колонна внешнего монтажа, душевой набор, верхний душ из латуни

Articolo	Note	CROMO	CR-C	CO-BR	O
0507WC-S		795,00	914,00	1.113,00	1.391,00
7007WC-S	VI	802,00	921,00	1.120,00	1.398,00
7107WC-S	LVC	804,00	923,00	1.122,00	1.400,00

0507

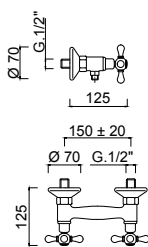
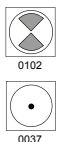

**Gruppo doccia esterno**

External shower mixer.  
Mitigeur extérieur de douche.  
Aufputz- Brausebatterie.  
Grupo ducha externo.  
Смеситель для душа внешнего монтажа

Articolo	Note	CROMO	CR-C	CO-BR	O
0507		108,00	124,00	151,00	189,00
7007	VI	115,00	131,00	158,00	196,00
7107	LVC	117,00	133,00	160,00	198,00

0501

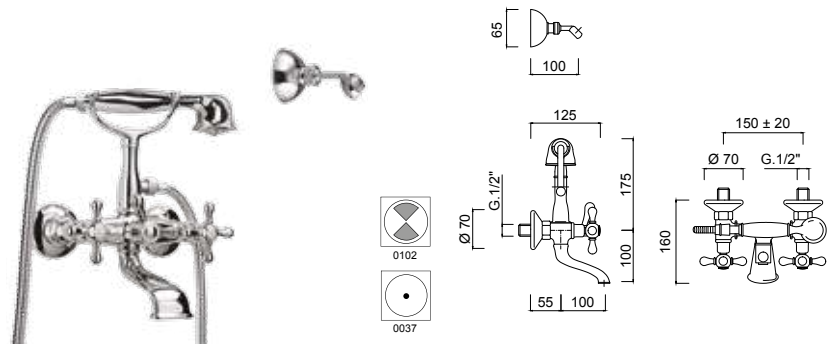

**Gruppo vasca esterno con set doccia duplex**

External bathtub set with duplex shower kit.  
Mélangeur bain-douche extérieur avec ensemble de douche duplex.  
Wannenbatterie mit Schlauch-Handbrause und verstellbarem Wandhalter.  
Grupo bañera externo con conjunto de ducha duplex.  
Комплект для ванны внешнего монтажа с душевым набором "Duplex".

Articolo	Note	CROMO	CR-C	CO-BR	O
0501		304,00	349,00	425,00	532,00
7001	VI	311,00	356,00	432,00	539,00
7101	LVC	313,00	358,00	434,00	541,00

0500

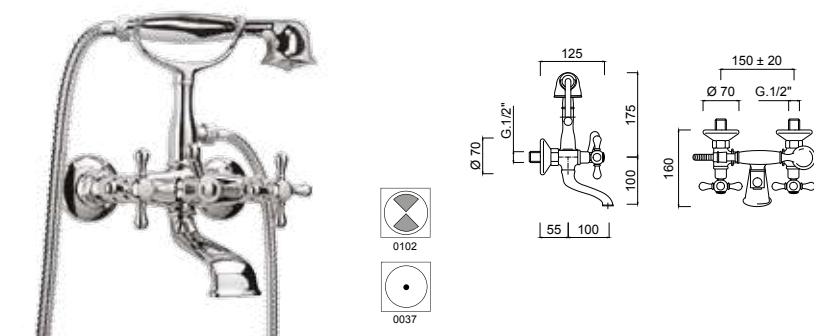

**Gruppo vasca esterno con doccia.**

External bathtub set with shower.  
Mélangeur bain-douche extérieur avec douchette.  
Wannenbatterie mit Schlauch-Handbrause nu verstellbarem Wandhalter.  
Grupo bañera externo con ducha.  
Внешний смеситель для ванны с душевой лейкой

Articolo	Note	CROMO	CR-C	CO-BR	O
0500		274,00	315,00	383,00	479,00
7000	VI	281,00	322,00	390,00	486,00
7100	LVC	283,00	324,00	392,00	488,00

0500CT



**Gruppo vasca esterno con doccia con colonne a pavimento.**

External bathtub set with floor pillar legs, flexible hose and hand shower.  
Mélangeur bain/douche avec colonnettes alimentation par le sol, flexible, douchette.  
Wannenbatterie mit Standfüßen, Schlauch und Handbrause.  
Grupo bañera externo con columnas a pavimento, flexible y ducha.  
Внешний смеситель для ванны на опорных ножках для напольной установки с душевой лейкой.

Articolo	Note	CROMO	CR-C	CO-BR	O
0500CT		700,00	805,00	980,00	1.225,00
7000CT	VI	707,00	812,00	987,00	1.232,00
7100CT	LVC	709,00	814,00	989,00	1.234,00

0503

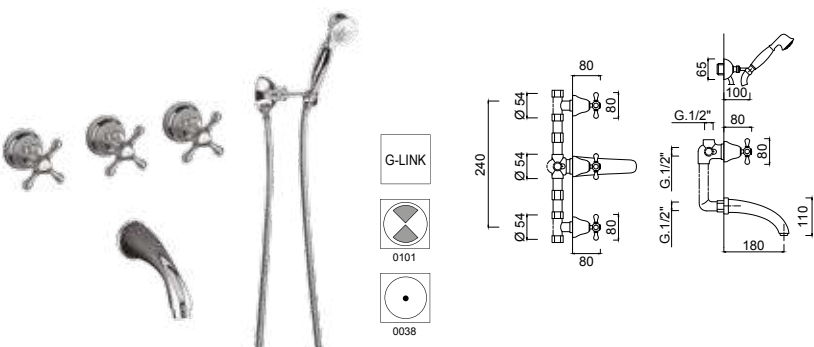

**Gruppo vasca incasso bocca a muro, doccia duplex.**

Built-in bath set, wall spout, duplex shower.  
Mélangeur bain/douche encastré avec douchette flexible et support.  
Unterputz-Wannenbatterie mit Schlauch Handbrause und Wandhalter.  
Grupo bañera para empotrar boca pegada al muro, ducha duplex.  
Встроенный в стену смеситель для ванны с душем.

Articolo	Note	CROMO	CR-C	CO-BR	O
0503		440,00	506,00	616,00	770,00
7003	VI	447,00	513,00	623,00	777,00
7103	LVC	449,00	515,00	625,00	779,00

0560

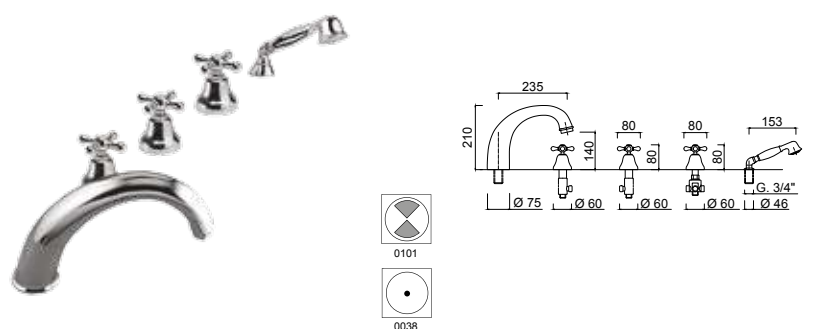

**Batteria bordo vasca 5 fori**

5-hole bath border set.  
Groupe mitigeur à 5 trous bord baignoire.  
5-Loch Wannen Kombination.  
Bateria borde bañera 5 agujeros.  
Комплект на борт ванны на 5 отверстий.

Articolo	Note	CROMO	CR-C	CO-BR	O
0560		595,00	684,00	833,00	1.041,00
7060	VI	602,00	691,00	840,00	1.048,00
7160	LVC	604,00	693,00	842,00	1.050,00

0565

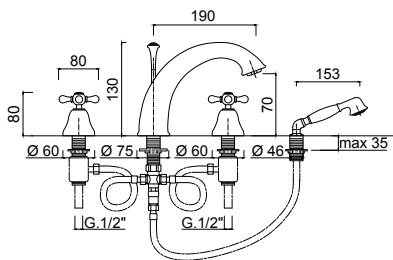
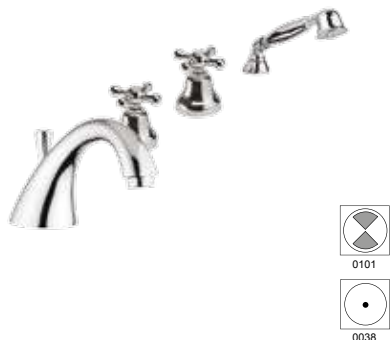

**Batteria bordo vasca 4 fori**  
4-hole bath border set.  
Groupe mitigeur à 4 trous bord baignoire.  
4-Loch Wannen Kombination.  
Bateria borde bañera 4 agujeros.  
Комплект на борт ванны на 4 отверстий.

Articolo	Note	CROMO	CR-C	CO-BR	O
0565		495,00	569,00	693,00	866,00
7065	VI	502,00	576,00	700,00	873,00
7165	LVC	504,00	578,00	702,00	875,00

0536

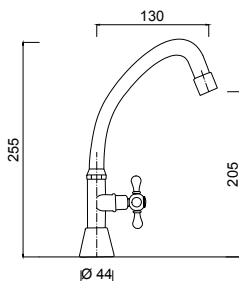

**Rubinetto a colonna.**  
Pillar type tap.  
Robinet à colonne  
Standventil Hahn  
Grifo de columna.  
Смеситель колонна

Articolo	Note	CROMO	CR-C	CO-BR	O
0536		80,00	•	107,00	•

0530

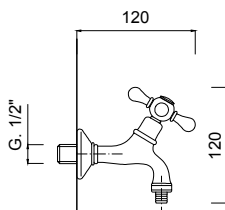

**Rubinetto per lavatrice 1/2".**  
1/2" tap for washing-machine.  
Robinet pour la machine à laver 1/2"  
1/2" Waschmaschinenhahn  
Grifo para lavadora 1/2".  
Смеситель для стиральной машины 1/2"

Articolo	Note	CROMO	CR-C	CO-BR	O
0530		58,00	•	•	•

0532

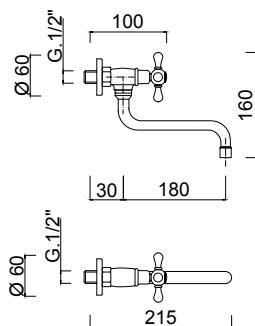

**Rubinetto a snodo 1/2".**  
1/2" swivel tap.  
Robinet vertical 1/2"  
Auslaufventil 1/2"  
Grifo con articulación 1/2".  
Смеситель с шарнирным соединением 1/2"

Articolo	Note	CROMO	CR-C	CO-BR	O
0532		61,00	•	88,00	•



0516

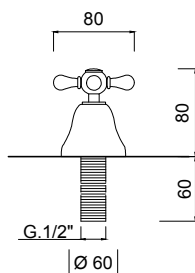

**Rubinetto incasso 1/2".**  
1/2" built-in tap.  
Robinet à encaissement 1/2".  
UP-Ventil 1/2".  
Grifo para empotrar 1/2".  
Вентиль встроенный 1/2".

Articolo	Note	CROMO	CR-C	CO-BR	O
0516		56,00	64,00	78,00	98,00
7016	VI	63,00	71,00	85,00	105,00
7116	LVC	65,00	73,00	87,00	107,00

0504

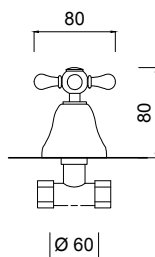
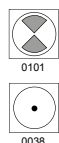

**Rubinetto bidet 1/2".**  
Bidet 1/2" tap.  
Robinet bidet 1/2"  
1/2" Hahn für Bidet  
Grifo bidet 1/2".  
Смеситель для биде 1/2"

Articolo	Note	CROMO	CR-C	CO-BR	O
0504		54,00	62,00	75,00	94,00
7004	VI	61,00	69,00	82,00	101,00
7104	LVC	63,00	71,00	84,00	103,00



VIENNA

**NOTE**

**Potete trovare altre soluzioni per la Doccia nell'area WELLNESS.** p.374  
For additional Shower options please go to WELLNESS section.  
Pour plus de solutions pour la Douche visitez la section WELLNESS.  
Für weitere Duschalternativen sehen Sie bitte in dem Kapitel WELLNESS nach.  
Para más soluciones para Ducha visite la sección WELLNESS.  
Другие решения для Душа вы найдете в разделе Wellness.

**Per gli Accessori Bagno abbinati alla serie potete consultare la serie IBISCO.** p.460  
For matching Bathroom Fittings please check IBISCO line.  
Pour les Accessoires Salle de Bains coordonnés à la collection visitez la ligne IBISCO.  
Die zu der Serie passenden Bad-Accessoires finden Sie in dem Linie IBISCO.  
Para los Accesorios de Baño compatibles con la serie visite la línea IBISCO.  
Чтобы подобрать подходящие аксессуары для ванной комнаты, перейдите в Линия IBISCO.



CONTEMPORARY

Lady



**6405A**

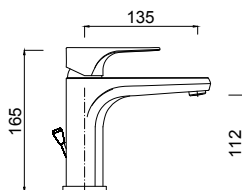

**Monocomando lavabo, scarico 1"1/4 (con flessibile).**  
Wash-basin single-lever mixer, 1"1/4 pop-up waste (with flexible).  
Mitigeur lavabo avec vidage 1"1/4 (avec flexible).  
Einhand-Waschtischbatterie mit Ablaufgarnitur 1"1/4 (mit flexiblen Anschlusschläuchen).  
Monomando lavabo tapón accionado por varilla 1"1/4 (con flexible).  
Однорычажный смеситель для раковины, донный клапан 1"1/4 (гибкая подводка).

Articolo	Note	CROMO			
<b>6405A</b>		137,00			

**6411A**

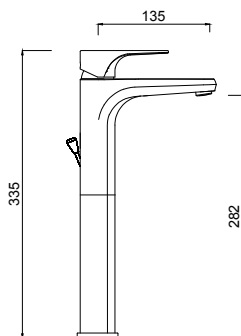

**Monocomando lavabo con prolunga, scarico 1"1/4 (con flessibile).**  
Wash-basin mixer with extension, 1"1/4 pop-up waste (with flexibles).  
Mitigeur lavabo rehaussé, vidage 1"1/4 (avec flexibles).  
Hoher Einhebel-Waschtischmischer, Ablaufgarnitur 1"1/4 (inkl. Anschlusschläuche).  
Monomando lavabo alto, desagüe automático 1"1/4 (con flex.).  
Смеситель для раковины с удлинением, донный клапан на 1"1/4 (с гибкими шлангами)

Articolo	Note	CROMO			
<b>6411A</b>		188,00			
<b>6411/SC</b>	SC	176,00			

**6407A**

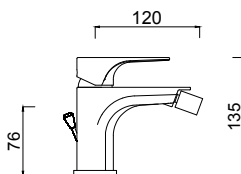

**Monocomando bidet, scarico 1"1/4 (con flessibile).**  
Bidet single-lever mixer, 1"1/4 pop-up waste (with flexible).  
Mélangeur bidet avec vidage 1"1/4 (avec flexible).  
Einhand-Bidetbatterie mit Ablaufgarnitur 1"1/4 (mit flexiblen Anschlusschläuchen).  
Monomando bidet, tapón accionado por varilla 1"1/4 (con flexible).  
Однорычажный смеситель для биде, донный клапан 1"1/4 (гибкая подводка).

Articolo	Note	CROMO			
<b>6407A</b>		137,00			

**6415WB**

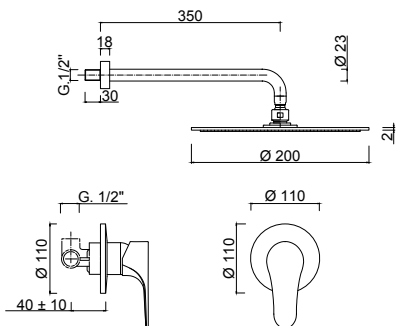

**Set doccia incasso monocomando, soffione ottone**  
Shower built-in single-lever mixer, brass shower head.  
Mitigeur pour douche à encaissement, pomme de douche en laiton.  
Unterputz-Duscheneinhebelmischer mit Kopfbrause, Kopfbrause in Messing.  
Monomando ducha para empotrar, rociador en latón.  
Однорычажный встроенный смеситель для душа, верхний душ из латуни

Articolo	Note	CROMO			
<b>6415WB</b>		271,00			

**6415WS**

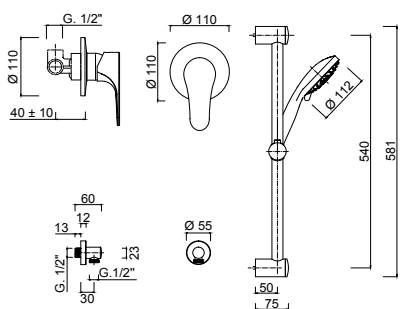

**Monocomando doccia esterno con saliscendi e doccia.**  
External single-lever shower mixer with sliding rail set.  
Mitigeur extérieur de douche avec barre coulissante et ensemble de douche.  
Aufputz-Einhand-Brausebatterie mit Brausestange und Brauseset.  
Monomando ducha exterior con conjunto de ducha.  
Однорычажный смеситель внешнего монтажа для душа с комплектом штанги для душа.

Articolo	Note	CROMO			
<b>6415WS</b>		181,00			

**6413KB**

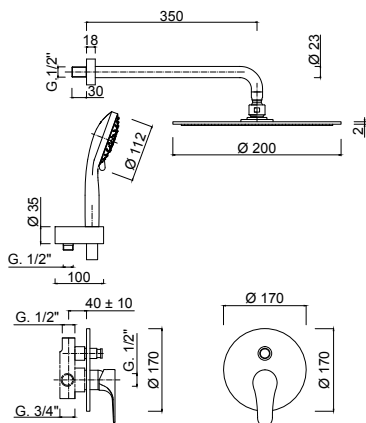
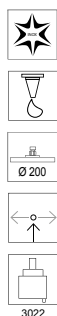

**Set doccia incasso monocomando con deviatore, soffione ottone, kit duplex incasso**

Shower built-in single-lever mixer with diverter, brass shower head, built-in duplex shower kit

Mitigeur pour douche à encaissement avec inverseur, pomme de douche en laiton, ensemble de douche duplex à encaissement

Unterputz-Duscheneinhebelmischer mit Umstellung, Brausekopf in Messing, Einbau-Brauseset Duplex

Monomando ducha para empotrar con desviador, rociador ducha en latón, conjunto ducha duplex para empotrar

Однорычажный встроенный смеситель для душа с дивертером, верхний душ из латуни, встроенный душевой набор "Duplex"

Articolo	Note	CROMO			
6413KB		468,00			

**6415**

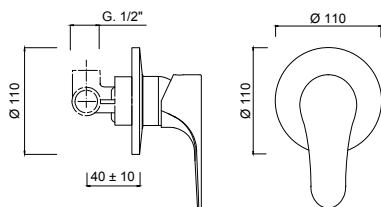

**Monocomando doccia incasso.**

Shower built-in single-lever mixer.

Mitigeur pour douche à encaissement.

Unterputz-Duscheneinhebelmischer.

Monomando ducha para empotrar.

Однорычажный встроенный смеситель для душа.

Articolo	Note	CROMO			
6415		75,00			

**6413**

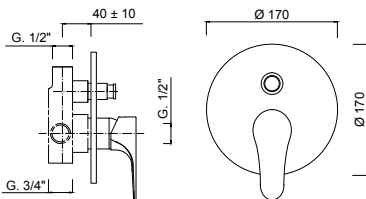
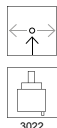

**Monocomando doccia incasso con deviatore.**

Shower built-in single-lever mixer with diverter.

Mitigeur pour douche à encaissement avec inverseur.

Unterputz-Duscheneinhebelmischer mit Umstellung.

Monomando ducha para empotrar con desviador.

Однорычажный встроенный смеситель для душа с дивертером.

Articolo	Note	CROMO			
6413		170,00			

**6408WS**

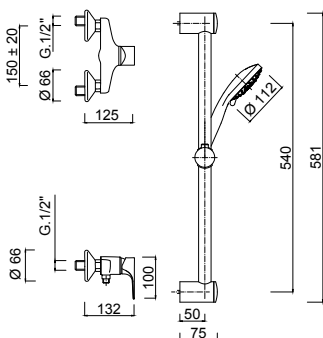
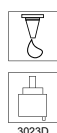

**Monocomando doccia esterno con saliscendi e doccia.**

External single-lever shower mixer with sliding rail set.

Mitigeur extérieur de douche avec barre coulissante et ensemble de douche.

Aufputz-Einhand-Brausebatterie mit Brausestange und Brauseset.

Monomando ducha exterior con conjunto de ducha.

Однорычажный смеситель внешнего монтажа для душа с комплектом штанги для душа.

Articolo	Note	CROMO			
6408WS		162,00			

6408

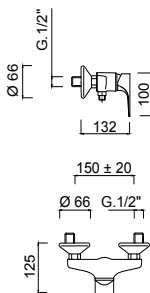

**Monocomando doccia esterno**

*External single-lever shower mixer.*

*Mitigeur pour douche externe.*

*Aufputz- Einhebelbatterie.*

*Monomando ducha externo.*

*Однорычажный смеситель внешнего монтажа для душа.*

Articolo	Note	CROMO			
6408		108,00			

6401

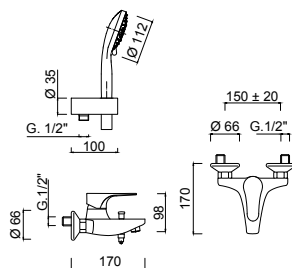

**Monocomando vasca esterno con set doccia duplex.**

*External bathtub single-lever mixer with duplex shower kit.*

*Mitigeur bain/douche extérieur avec ensemble de douche duplex.*

*Für weitere Duschalternativen sehen Sie bitte in dem Kapitel WELLNESS nach.*

*Monomando bañera externo con conjunto de ducha duplex.*

*Однорычажный смеситель внешнего монтажа для ванны с душевым набором "Duplex"*

Articolo	Note	CROMO			
6401		210,00			

**NOTE**

**Potete trovare altre soluzioni per la Doccia nell'area WELLNESS.**

**p.374**

*For additional Shower options please go to WELLNESS section.*

*Pour plus de solutions pour la Douche visitez la section WELLNESS.*

*Für weitere Duschalternativen sehen Sie bitte in dem Kapitel WELLNESS nach.*

*Para más soluciones para Ducha visite la sección WELLNESS.*

*Другие решения для Душа вы найдете в разделе Wellness.*

**Per gli Accessori Bagno abbinati alla serie potete consultare la serie MODERNA.**

**p.446**

*For matching Bathroom Fittings please check MODERNA line.*

*Pour les Accessoires Salle de Bains coordonnés à la collection visitez la ligne MODERNA.*

*Die zu der Serie passenden Bad-Accessoires finden Sie in dem Linie MODERNA.*

*Para los Accesorios de Baño compatibles con la serie visite la línea MODERNA.*

*Чтобы подобрать подходящие аксессуары для ванной комнаты, перейдите в Линия MODERNA.*





Linea



**6305A**

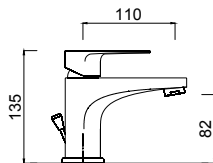

**Monocomando lavabo, scarico 1"1/4 (con flessibile).**  
Wash-basin single-lever mixer, 1"1/4 pop-up waste (with flexible).  
Mitigeur lavabo avec vidage 1"1/4 (avec flexible).  
Einhand-Waschtischbatterie mit Ablaufgarnitur 1"1/4 (mit flexiblen Anschlusschläuchen).  
Monomando lavabo tapón accionado por varilla 1"1/4 (con flexible).  
Однорычажный смеситель для раковины, донный клапан 1"1/4 (гибкая подводка).

Articolo	Note	CROMO			
<b>6305A</b>		120,00			

**6306A**

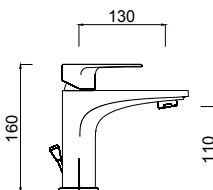

**Monocomando lavabo medio, scarico 1"1/4 (con flessibile).**  
Wash-basin mixer, 1"1/4 pop-up waste (with flexibles).  
Mitigeur lavabo, vidage 1"1/4 (avec flexibles).  
Einhebel-Waschtischmischer, Ablaufgarnitur 1"1/4 (inkl. Anschlusschläuche).  
Monomando lavabo, desagüe automatico 1"1/4 (con flex.).  
Смеситель для раковины, донный клапан на 1"1/4 (с гибкими шлангами)

Articolo	Note	CROMO			
<b>6406A</b>		134,00			

**6311A**

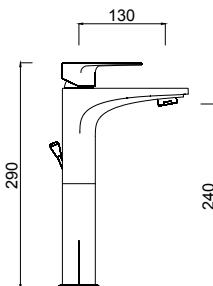

**Monocomando lavabo medio con prolunga, scarico 1"1/4 (con flessibile).**  
Wash-basin mixer with extension, 1"1/4 pop-up waste (with flexibles).  
Mitigeur lavabo rehaussé, vidage 1"1/4 (avec flexibles).  
Hoher Einhebel-Waschtischmischer, Ablaufgarnitur 1"1/4 (inkl. Anschlusschläuche).  
Monomando lavabo alto, desagüe automatico 1"1/4 (con flex.).  
Смеситель для раковины с удлинением, донный клапан на 1"1/4 (с гибкими шлангами)

Articolo	Note	CROMO			
<b>6311A</b>		184,00			
<b>6311/SC</b>	SC	172,00			

**6307A**

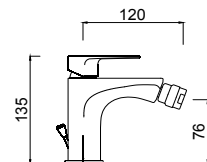

**Monocomando bidet, scarico 1"1/4 (con flessibile).**  
Bidet single-lever mixer, 1"1/4 pop-up waste (with flexible).  
Mélangeur bidet avec vidage 1"1/4 (avec flexible).  
Einhand-Bidetbatterie mit Ablaufgarnitur 1"1/4 (mit flexiblen Anschlusschläuchen).  
Monomando bidet, tapón accionado por varilla 1"1/4 (con flexible).  
Однорычажный смеситель для биде, донный клапан 1"1/4 (гибкая подводка).

Articolo	Note	CROMO			
<b>6307A</b>		120,00			

**6315WB**

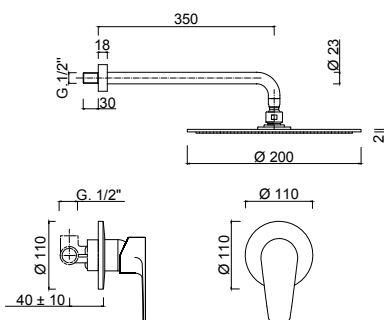

**Set doccia incasso monocomando, soffione Inox**  
Concealed single-lever shower mixer, inox shower head.  
Mitigeur pour douche à encaissement, pomme de douche en inox.  
Unterputz-Duscheneinhebelmischer, Kopfbrause in inox.  
Monomando ducha para empotrar, rociador en inox.  
Однорычажный встроенный смеситель для душа, верхний душ Inox.

Articolo	Note	CROMO			
<b>6315WB</b>		271,00			

**6315WS**

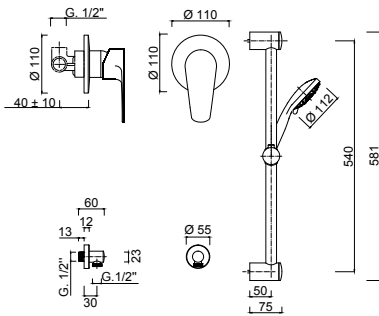

**Set doccia incasso monocomando, saliscendi, presa acqua.**  
Built-in shower mixer with sliding rail and water plug.  
Mitigeur douche à encastrer avec barre de douche et prise d'eau.  
UP-Einhebel-Brausemischer mit Brausestange, Brauseset und Wandanschlussbogen.  
Kit de ducha empotrado con barra deslizante y toma de agua.  
Встраиваемый смеситель для душа с регулируемой штангой и разъемом для подачи воды

Articolo	Note	CROMO			
6315WS		181,00			

**6313KB**

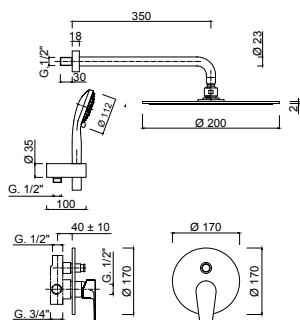
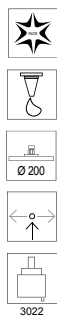

**Set doccia incasso monocomando con deviatore, soffione Inox, kit duplex incasso**  
Shower built-in single-lever mixer with diverter, Inox shower head, built-in duplex shower kit  
Mitigeur pour douche à encaissement avec inverseur, pomme de douche en Inox, ensemble de douche duplex à encaissement  
Unterputz-Duscheneinhebelmischer mit Umstellung, Brausekopf in Inox, Einbau-Brauseset Duplex  
Monomando ducha para empotrar con desviador, rociador ducha en Inox, conjunto ducha duplex para empotrar  
Однорычажный встроенный смеситель для душа с дивертером, верхний душ из нержавеющей стали, встроенный душевой набор "Duplex"

Articolo	Note	CROMO			
6313KB		468,00			

**6315**

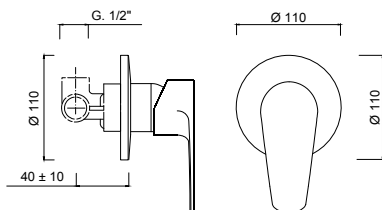

**Monocomando doccia incasso.**  
Shower built-in single-lever mixer.  
Mitigeur pour douche à encaissement.  
Unterputz-Duscheneinhebelmischer.  
Monomando ducha para empotrar.  
Однорычажный встроенный смеситель для душа.

Articolo	Note	CROMO			
6315		75,00			

**6313**

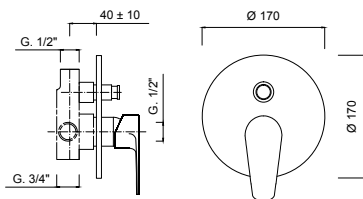
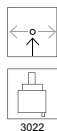

**Monocomando doccia incasso con deviatore.**  
Shower built-in single-lever mixer with diverter.  
Mitigeur pour douche à encaissement avec inverseur.  
Unterputz-Duscheneinhebelmischer mit Umstellung.  
Monomando ducha para empotrar con desviador.  
Однорычажный встроенный смеситель для душа с дивертером.

Articolo	Note	CROMO			
6313		170,00			

**6308WS**

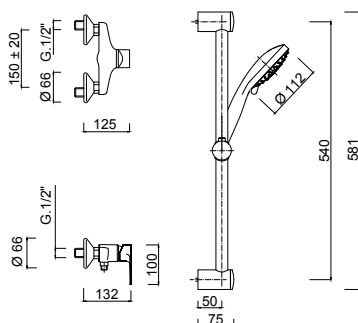
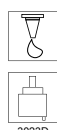

**Monocomando doccia esterno con saliscendi e doccia.**  
External single-lever shower mixer with sliding rail set.  
Mitigeur extérieur de douche avec barre coulissante et ensemble de douche.  
Aufputz-Einhand-Brausebatterie mit Brausestange und Brauseset.  
Monomando ducha exterior con conjunto de ducha y barra deslizante  
Однорычажный смеситель внешнего монтажа для душа с комплектом штанги для душа.

Articolo	Note	CROMO			
6308WS		162,00			

6308



3023D

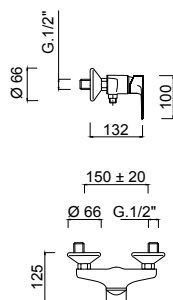

**Monocomando doccia esterno**

External single-lever shower mixer.  
Mitigeur pour douche externe.  
Aufputz- Einhebelbatterie.  
Monomando ducha externo.  
Однорычажный смеситель внешнего монтажа для душа.

Articolo	Note	CROMO			
6308		108,00			

6301



3023D

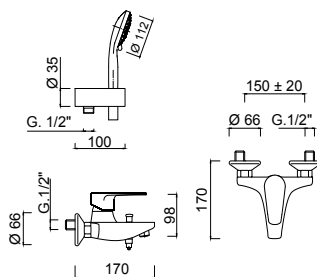

**Monocomando vasca esterno con set doccia duplex.**

External bathtub single-lever mixer with duplex shower kit.  
Mitigeur bain/douche extérieur avec ensemble de douche duplex.  
Für weitere Duschalternativen sehen Sie bitte in dem Kapitel WELLNESS nach.  
Monomando bañera externo con conjunto de ducha duplex.  
Однорычажный смеситель внешнего монтажа для ванны с душевым набором "Duplex"

Articolo	Note	CROMO			
6301		210,00			

**NOTE**

**Potete trovare altre soluzioni per la Doccia nell'area WELLNESS. p.374**  
For additional Shower options please go to WELLNESS section.  
Pour plus de solutions pour la Douche visitez la section WELLNESS.  
Für weitere Duschalternativen sehen Sie bitte in dem Kapitel WELLNESS nach.  
Para más soluciones para Ducha visite la sección WELLNESS.  
Другие решения для Душа вы найдете в разделе Wellness.

**Per gli Accessori Bagno abbinati alla serie potete consultare la serie MODERNA. p.446**  
For matching Bathroom Fittings please check MODERNA line.  
Pour les Accessoires Salle de Bains coordonnés à la collection visitez la ligne MODERNA.  
Die zu der Serie passenden Bad-Accessoires finden Sie in dem Linie MODERNA.  
Para los Accesorios de Baño compatibles con la serie visite la línea MODERNA.  
Чтобы подобрать подходящие аксессуары для ванной комнаты, перейдите в Линия MODERNA.



Corner





6805A

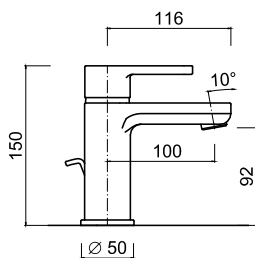

**Monocomando lavabo, scarico 1"1/4 (con flessibile).**  
Wash-basin single-lever mixer, 1"1/4 pop-up waste (with flexible).  
Mitigeur lavabo avec vidage 1"1/4 (avec flexible).  
Einhand-Waschtischbatterie mit Ablaufgarnitur 1"1/4 (mit flexiblen Anschlussschläuchen).  
Monomando lavabo tapón accionado por varilla 1"1/4 (con flexible).  
Однорычажный смеситель для раковины, донный клапан 1"1/4 (гибкая подводка).

Articolo	Note	CROMO		
6805A		155,00		

6811/SC

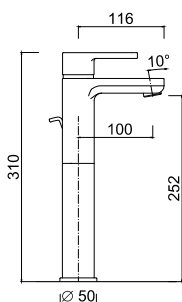
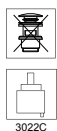

**Monocomando lavabo con prolunga, senza scarico (con flessibile).**  
Wash-basin mixer with extension, without pop-up waste (with flexibles).  
Mitigeur lavabo rehaussé, sans vidage (avec flexibles).  
Hoher Einhebel-Waschtischmischer, ohne Ablaufgarnitur (inkl. Anschlussschläuche).  
Monomando lavabo alto, sin desagüe automático (con flex.).  
Смеситель для раковины с удлинением, без донного клапана (с гибкими шлангами)

Articolo	Note	CROMO		
6811/SC		187,00		

6807A

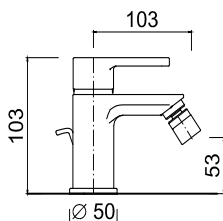

**Monocomando bidet, scarico 1"1/4 (con flessibile).**  
Bidet single-lever mixer, 1"1/4 pop-up waste (with flexible).  
Mélangeur bidet avec vidage 1"1/4 (avec flexible).  
Einhand-Bidetbatterie mit Ablaufgarnitur 1"1/4 (mit flexiblen Anschlussschläuchen).  
Monomando bidet, tapón accionado por varilla 1"1/4 (con flexible).  
Однорычажный смеситель для биде, донный клапан 1"1/4 (гибкая подводка).

Articolo	Note	CROMO		
6807A		155,00		

6815

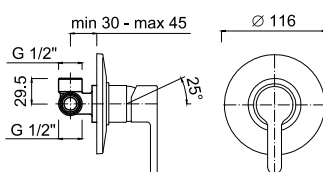

**Monocomando doccia incasso.**  
Shower built-in single-lever mixer.  
Mitigeur pour douche à encaissement.  
Unterputz-Duscheneinhebelmischer.  
Monomando ducha para empotrar.  
Однорычажный встроенный смеситель для душа.

Articolo	Note	CROMO		
6815		75,00		

6813

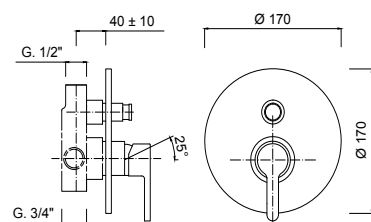
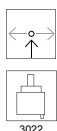

**Monocomando doccia incasso con deviatore.**  
Shower built-in single-lever mixer with diverter.  
Mitigeur pour douche à encaissement avec inverseur.  
Unterputz-Duscheneinhebelmischer mit Umstellung.  
Monomando ducha para empotrar con desviador.  
Однорычажный встроенный смеситель для душа с дивертером.

Articolo	Note	CROMO		
6813		178,00		

6808

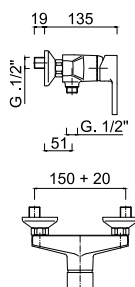

**Monocomando doccia esterno**

External single-lever shower mixer.

Mitigeur pour douche externe.

Aufputz- Einhebelbatterie.

Monomando ducha externo.

Однорычажный смеситель внешнего монтажа для душа.

Articolo	Note	CROMO			
6808		155,00			

6801

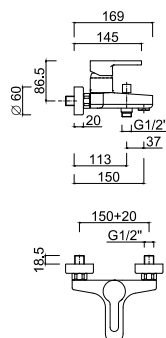

**Monocomando vasca esterno con set doccia duplex.**

External bathtub single-lever mixer with duplex shower kit.

Mitigeur bain/douche extérieur avec ensemble de douche duplex.

Aufputz- Einhebelmischer für die Badewanne mit Brauseset Duplex.

Monomando bañera externo con conjunto de ducha duplex.

Однорычажный смеситель внешнего монтажа для ванны с душевым набором "Duplex"

Articolo	Note	CROMO			
6801		255,00			

**NOTE**

**Potete trovare altre soluzioni per la Doccia nell'area WELLNESS.**

**p.374**

For additional Shower options please go to WELLNESS section.

Pour plus de solutions pour la Douche visitez la section WELLNESS.

Für weitere Duschalternativen sehen Sie bitte in dem Kapitel WELLNESS nach.

Para más soluciones para Ducha visite la sección WELLNESS.

Другие решения для Душа вы найдете в разделе Wellness.

**Per gli Accessori Bagno abbinati alla serie potete consultare la serie MODERNA.**

**p.446**

For matching Bathroom Fittings please check MODERNA line.

Pour les Accessoires Salle de Bains coordonnés à la collection visitez la ligne MODERNA.

Die zu der Serie passenden Bad-Accessoires finden Sie in dem Linie MODERNA.

Para los Accesorios de Baño compatibles con la serie visite la línea MODERNA.

Чтобы подобрать подходящие аксессуары для ванной комнаты, перейдите в Линия MODERNA.

# KellyGreen

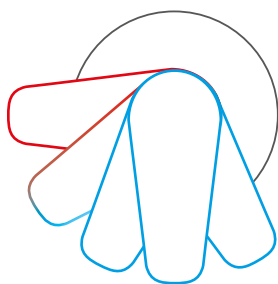

## ECOSAVE

Si ottiene utilizzando una specifica cartuccia che, con la leva in posizione allineata rispetto alla bocca del rubinetto, evita la richiesta di acqua calda, permettendo perciò un risparmio energetico.

*Is achieved by using a specific cartridge opening only cold water, with the lever in aligned position relative to faucet spout. In that position the hot water way is not opened.*



Aeratore a risparmio d'acqua, 5lt/min  
Water saving aerator, 5lt/min



**2905A**

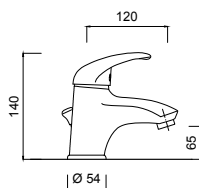

**Monocomando lavabo, scarico 1"1/4 (con flessibile).**  
Wash-basin single-lever mixer, 1"1/4 pop-up waste (with flexible).  
Mitigeur lavabo avec vidage 1"1/4 (avec flexible).  
Einhand-Waschtischbatterie mit Ablaufgarnitur 1"1/4 (mit flexiblen Anschlussschläuchen).  
Monomando lavabo tapón accionado por varilla 1"1/4 (con flexible).  
Однорычажный смеситель для раковины, донный клапан 1"1/4 (гибкая подводка).

Articolo	Note	CROMO		
2905A		132,00		

**2907A**

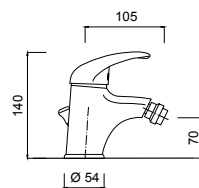

**Monocomando bidet, scarico 1"1/4 (con flessibile).**  
Bidet single-lever mixer, 1"1/4 pop-up waste (with flexible).  
Mélangeur bidet avec vidage 1"1/4 (avec flexible).  
Einhand-Bidetbatterie mit Ablaufgarnitur 1"1/4 (mit flexiblen Anschlussschläuchen).  
Monomando bidet, tapón accionado por varilla 1"1/4 (con flexible).  
Однорычажный смеситель для биде, донный клапан 1"1/4 (гибкая подводка).

Articolo	Note	CROMO		
2907A		132,00		

**2915WB**

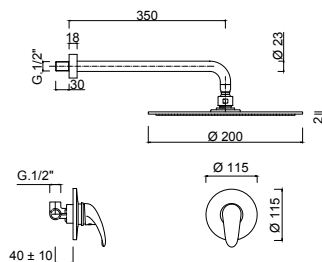

**Set doccia incasso monocomando, soffione Inox**  
Concealed single-lever shower mixer, Inox shower head.  
Mitigeur pour douche à encaissement, pomme de douche en Inox.  
Unterputz-Duscheneinhebelmischer, Kopfbrause in Inox.  
Monomando ducha para empotrar, rociador en Inox.  
Однорычажный встроенный смеситель для душа, верхний душ Inox.

Articolo	Note	CROMO		
29015WB		279,00		

**2911KB**

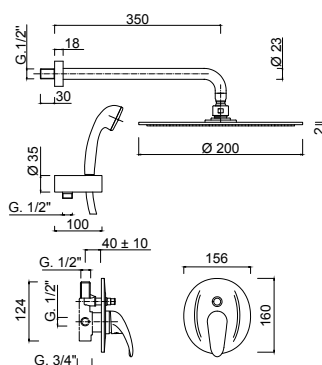
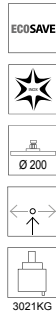

**Set doccia incasso monocomando con deviatore, soffione Inox kit duplex incasso**  
Shower built-in single-lever mixer with diverter, Inox shower head, built-in duplex shower kit  
Mitigeur pour douche à encaissement avec inverseur, pomme de douche en Inox ensemble de douche duplex à encaissement  
Unterputz- Duscheneinhebelmischer mit Umstellung, Brausekopf in Inox Einbau- Brauseset Duplex  
Monomando ducha para empotrar con desviador, rociador ducha en Inox, conjunto ducha duplex para empotrar  
Однорычажный встроенный смеситель для душа с дивертером, верхний душ из Inox, встроенный душевой набор "Duplex"

Articolo	Note	CROMO		
2911KB		448,00		

**2915**

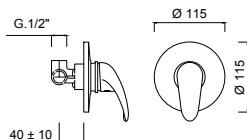
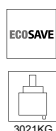

**Monocomando doccia incasso.**  
Shower built-in single-lever mixer.  
Mitigeur pour douche à encaissement.  
Unterputz-Duscheneinhebelmischer.  
Monomando ducha para empotrar.  
Однорычажный встроенный смеситель для душа.

Articolo	Note	CROMO		
2915		80,00		

2911



3021KG

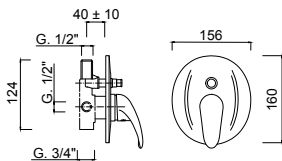

**Monocomando doccia incasso con deviatore.**

*Shower built-in single-lever mixer with diverter.*

*Mitigeur pour douche à encaissement avec inverseur.*

*Unterputz- Duscheneinhebelmischer mit Umstellung.*

*Monomando ducha para empotrar con desviador.*

*Однорычажный встроенный смеситель для душа с дивертером.*

Articolo	Note	CROMO		
2911		158,00		

2908WS



3021KG

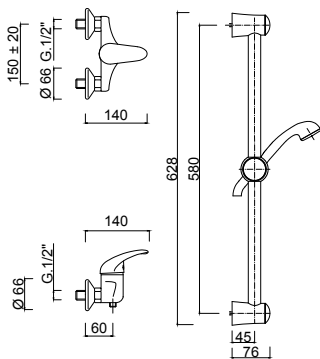

**Monocomando doccia esterno con saliscendi e doccia.**

*External single-lever shower mixer with sliding rail set.*

*Mitigeur extérieur de douche avec barre coulissante et ensemble de douche.*

*Aufputz- Einhand-Brausebatterie mit Brausestange und Brauseset.*

*Monomando ducha exterior con conjunto de ducha y barra deslizante.*

*Однорычажный смеситель внешнего монтажа для душа с комплектом штанги для душа.*

Articolo	Note	CROMO		
2908WS		176,00		

2908



3021KG

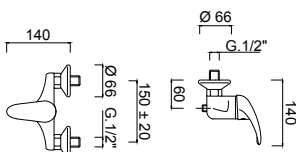

**Monocomando doccia esterno**

*External single-lever shower mixer.*

*Mitigeur pour douche externe.*

*Aufputz- Einhebelbatterie.*

*Monomando ducha externo.*

*Однорычажный смеситель внешнего монтажа для душа.*

Articolo	Note	CROMO		
2908		105,00		

2901



3021KGD

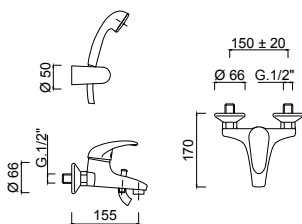

**Monocomando vasca esterno con set doccia duplex.**

*External bathtub single-lever mixer with duplex shower kit.*

*Mitigeur bain/douche extérieur avec ensemble de douche duplex.*

*Aufputz- Einhebelmischer für die Badewanne mit Brauseset Duplex.*

*Monomando bañera externo con conjunto de ducha duplex.*

*Однорычажный смеситель внешнего монтажа для ванны с душевым набором "Duplex"*

Articolo	Note	CROMO		
2901		181,00		

**NOTE**

**Potete trovare altre soluzioni per la Doccia nell'area WELLNESS.**

*For additional Shower options please go to WELLNESS section.*

*Pour plus de solutions pour la Douche visitez la section WELLNESS.*

*Für weitere Duschalternativen sehen Sie bitte in dem Kapitel WELLNESS nach.*

*Para más soluciones para Ducha visite la sección WELLNESS.*

*Другие решения для Душа вы найдете в разделе Wellness.*

p.374

Kelly

Mery





**2505A**

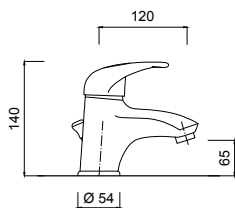

**Monocomando lavabo, scarico 1"1/4 (con flessibile).**  
Wash-basin single-lever mixer, 1"1/4 pop-up waste (with flexible).  
Mitigeur lavabo avec vidage 1"1/4 (avec flexible).  
Einhand-Waschtischbatterie mit Ablaufgarnitur 1"1/4 (mit flexiblen Anschlussschläuchen).  
Monomando lavabo tapón accionado por varilla 1"1/4 (con flexible).  
Однорычажный смеситель для раковины, донный клапан 1"1/4 (гибкая подводка).

Articolo	Note	CROMO	BLC-BLO		
2505A		120,00	156,00		
2405A	MERY	120,00	156,00		

**2527A**

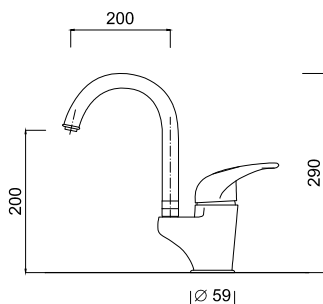

**Monocomando lavabo, bocca girevole, scarico 1"1/4 (con flessibile).**  
Wash-basin mixer, swivel spout, 1"1/4 pop-up waste (with flexible).  
Mitigeur lavabo, bec mobile, vidage automatique 1"1/4 (avec flex.).  
Waschtisch-Einhebelmischer, schwenkbarer Rohrauslauf, 1"1/4 Zugknopf Ablaufgarnitur (mit flexiblen Anschlussschläuchen).  
Monomando lavabo, caño giratorio, tapón accionado por varilla 1"1/4 (con flex.).  
Смеситель для раковины, поворотный излив, донный клапан 1"1/4 (гибкая подводка).

Articolo	Note	CROMO	BLC-BLO		
2527A		185,00	•		
2427A	MERY	185,00	•		

**2522A**

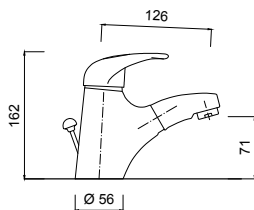

**Monocomando lavabo con doccetta estraibile, scarico 1"1/4 (con flessibile).**  
Wash-basin mixer with extractable hand-shower, 1"1/4 pop-up waste (with flexibles).  
Mitigeur lavabo avec douchette extractible, vidage 1"1/4 (avec flexibles).  
Einhebel-Waschtischmischer mit Ausziehauslauf, Ablaufgarnitur 1"1/4 (inkl. Anschlussschläuche).  
Monomando lavabo con caño extraíble, desagüe automático 1"1/4 (con flex.).  
Смеситель для раковины с выдвигаемым ручным душем, донный клапан на 1"1/4 (с гибкими шлангами)

Articolo	Note	CROMO	BLC-BLO		
2522A		275,00	•		
2422A	MERY	275,00	•		

**2507A**

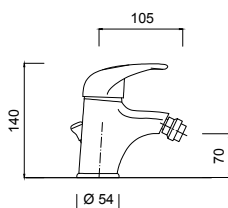

**Monocomando bidet, scarico 1"1/4 (con flessibile).**  
Bidet single-lever mixer, 1"1/4 pop-up waste (with flexible).  
Mélangeur bidet avec vidage 1"1/4 (avec flexible).  
Einhand-Bidetbatterie mit Ablaufgarnitur 1"1/4 (mit flexiblen Anschlussschläuchen).  
Monomando bidet, tapón accionado por varilla 1"1/4 (con flexible).  
Однорычажный смеситель для биде, донный клапан 1"1/4 (гибкая подводка).

Articolo	Note	CROMO	BLC-BLO		
2507A		120,00	156,00		
2407A	MERY	120,00	156,00		

**2529A**

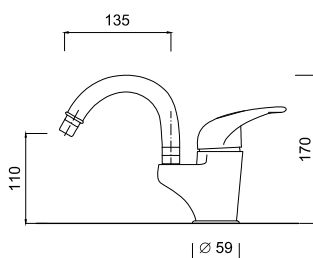

**Monocomando bidet, bocca girevole, scarico 1"1/4 lusso (con flessibile)**  
Bidet mixer, swivel spout, 1"1/4 pop-up waste (with flexible).  
Mitigeur bidet, bec mobile, vidage automatique 1"1/4 (avec flex.).  
Bidet-Einhebelmischer, Rohrauslauf schwenkbarer, 1"1/4 Zugknopf Ablaufgarnitur (mit flexiblen Anschlussschläuchen).  
Monomando bidet, caño giratorio, tapón accionado por varilla 1"1/4 (con flex.).  
Смеситель для биде, поворотный излив, донный клапан 1"1/4 (гибкая подводка).

Articolo	Note	CROMO	BLC-BLO		
2529A		185,00	•		
2429A	MERY	185,00	•		



2508

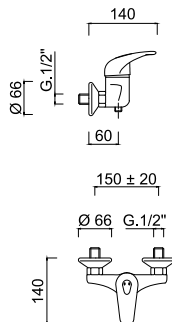

**Monocomando doccia esterno**

External single-lever shower mixer.

Mitigeur pour douche externe.

Aufputz- Einhebelbatterie.

Monomando ducha externo.

Однорычажный смеситель внешнего монтажа для душа.

Articolo	Note	CROMO	BLC-BLO		
2508		103,00	134,00		
2408	MERY	103,00	134,00		

2501

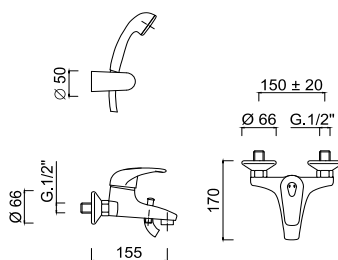

**Monocomando vasca esterno con set doccia duplex.**

External bathtub single-lever mixer with duplex shower kit.

Mitigeur bain/douche extérieure avec ensemble de douche duplex.

Aufputz- Einhebelmischer für die Badewanne mit Brauseset Duplex.

Monomando bañera externo con conjunto de ducha duplex.

Однорычажный смеситель внешнего монтажа для ванны с душевым набором "Duplex"

Articolo	Note	CROMO	BLC-BLO		
2501		174,00	227,00		
2401	MERY	174,00	227,00		

2540

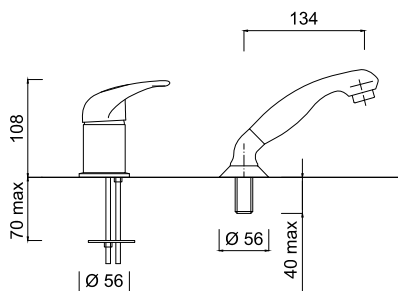

**Monocomando per lavabo parrucchiere con doccetta laterale estraibile.**

Single-lever hairdresser wash-basin mixer with side pull-out shower.

Mitigeur lavabo avec accessoire de douche extraible

Einhebel-Waschtisch mischer für Friseure mit Ausziehhand brause

Monomando lavabo peluquero con ducha lateral extraible.

Однорычажный для парикмахерских умывальник смесителя с боковой выдвигающей душ.

Articolo	Note	CROMO	BLC-BLO		
2540		189,00	•		
2440	MERY	189,00	•		



**MERY**

**NOTE**

**Potete trovare altre soluzioni per la Doccia nell'area WELLNESS.**

**p.374**

For additional Shower options please go to WELLNESS section.

Pour plus de solutions pour la Douche visitez la section WELLNESS.

Für weitere Duschalternativen sehen Sie bitte in dem Kapitel WELLNESS nach.

Para más soluciones para Ducha visite la sección WELLNESS.

Другие решения для Душа вы найдете в разделе Wellness.



Roma



**2605A**

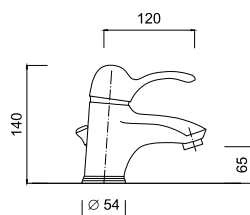

3021D

**Monocomando lavabo, scarico 1"1/4 (con flessibile).**  
Wash-basin single-lever mixer, 1"1/4 pop-up waste (with flexible).  
Mitigeur lavabo avec vidage 1"1/4 (avec flexible).  
Einhand-Waschtischbatterie mit Ablaufgarnitur 1"1/4 (mit flexiblen Anschlussschläuchen).  
Monomando lavabo tapón accionado por varilla 1"1/4 (con flexible).  
Однорычажный смеситель для раковины, донный клапан 1"1/4 (гибкая подводка).

Articolo	Note	CROMO	CR	BR	O
<b>2605A</b>		138,00	151,00	200,00	248,00

**2607A**

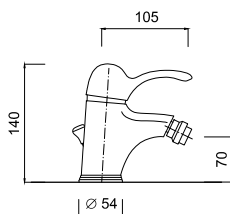

3021D

**Monocomando bidet, scarico 1"1/4 (con flessibile).**  
Bidet single-lever mixer, 1"1/4 pop-up waste (with flexible).  
Mélangeur bidet avec vidage 1"1/4 (avec flexible).  
Einhand-Bidetbatterie mit Ablaufgarnitur 1"1/4 (mit flexiblen Anschlussschläuchen).  
Monomando bidet, tapón accionado por varilla 1"1/4 (con flexible).  
Однорычажный смеситель для биде, донный клапан 1"1/4 (гибкая подводка).

Articolo	Note	CROMO	CR	BR	O
<b>2607A</b>		138,00	151,00	200,00	248,00

**2615WB**

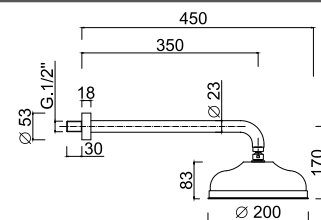

3021

**Set doccia incasso monocomando, soffione ottone**  
Shower built-in single-lever mixer, brass shower head.  
Mitigeur pour douche à encaissement, pomme de douche en laiton.  
Unterputz-Duscheneinhebelmischer, Kopfbrause in Messing.  
Monomando ducha para empotrar, rociador en latón.  
Однорычажный встроенный смеситель для душа, верхний душ из латуны

Articolo	Note	CROMO	CR	BR	O
<b>2615WB</b>		329,00	362,00	442,00	503,00

**2611KB**

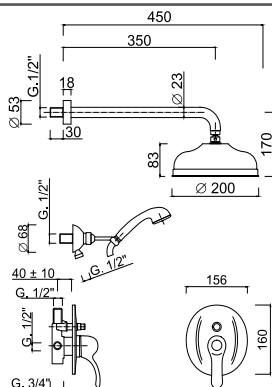

3021

**Set doccia incasso monocomando con deviatore, soffione ottone, kit duplex incasso**  
Shower built-in single-lever mixer with diverter, brass shower head, built-in duplex shower kit  
Mitigeur pour douche à encaissement avec inverseur, pomme de douche en laiton, ensemble de douche duplex à encaissement  
Unterputz- Duscheneinhebelmischer mit Umstellung, Brausekopf in Messing, Einbau- Brauseset Duplex  
Monomando ducha para empotrar con desviador, rociador ducha en latón, conjunto ducha duplex para empotrar  
Однорычажный встроенный смеситель для душа с дивертером, верхний душ из латуны, встроенный душевой набор "Duplex"

Articolo	Note	CROMO	CR	BR	O
<b>2611KB</b>		484,00	532,00	731,00*	902,00*

**2615**

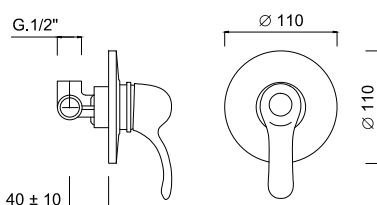

3021

**Monocomando doccia incasso.**  
Shower built-in single-lever mixer.  
Mitigeur pour douche à encaissement.  
Unterputz-Duscheneinhebelmischer.  
Monomando ducha para empotrar.  
Однорычажный встроенный смеситель для душа.

Articolo	Note	CROMO	CR	BR	O
<b>2615</b>		80,00	85,00	116,00	144,00



2611

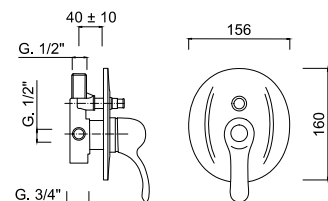
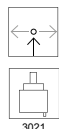

**Monocomando doccia incasso con deviatore.**

Shower built-in single-lever mixer with diverter.  
Mitigeur pour douche à encaissement avec inverseur.  
Unterputz- Duscheneinhebelmischer mit Umstellung.  
Monomando ducha para empotrar con desviador.  
Однорычажный встроенный смеситель для душа с дивертером.

Articolo	Note	CROMO	CR	BR	O
2611		168,00	176,80	243,00	302,00

2608WS

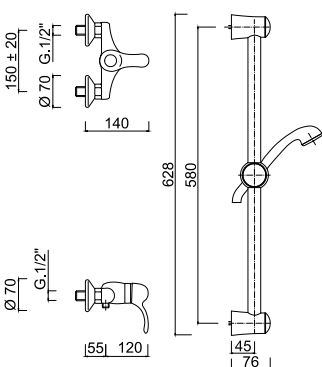
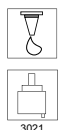

**Monocomando doccia esterno con saliscendi e doccia.**

External single-lever shower mixer with sliding rail set.  
Mitigeur extérieur de douche avec barre coulissante et ensemble de douche.  
Aufputz- Einhand-Brausebatterie mit Brausestange und Brauseset.  
Monomando ducha exterior con conjunto de ducha y barra deslizante  
Однорычажный смеситель внешнего монтажа для душа с комплектом штанги для душа.

Articolo	Note	CROMO	CR	BR	O
2608WS		182,00	201,00	429,00*	588,00*

2608

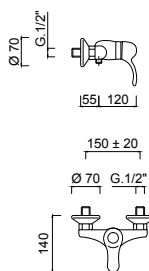

**Monocomando doccia esterno**

External single-lever shower mixer.  
Mitigeur pour douche externe.  
Aufputz- Einhebelbatterie.  
Monomando ducha externo.  
Однорычажный смеситель внешнего монтажа для душа.

Articolo	Note	CROMO	CR	BR	O
2608		110,00	116,80	159,00	198,00

2601

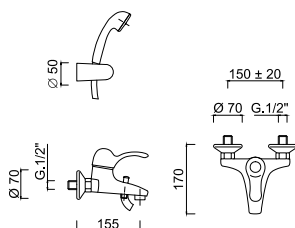
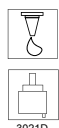

**Monocomando vasca esterno con set doccia duplex.**

External bathtub single-lever mixer with duplex shower kit.  
Mitigeur bain/douche extérieur avec ensemble de douche duplex.  
Aufputz- Einhebelmischer für die Badewanne mit Brauseset Duplex.  
Monomando bañera externo con conjunto de ducha duplex.  
Однорычажный смеситель внешнего монтажа для ванны с душевым набором "Duplex"

Articolo	Note	CROMO	CR	BR	O
2601		200,00	220,00	300,00*	360,00*

**2665BD**

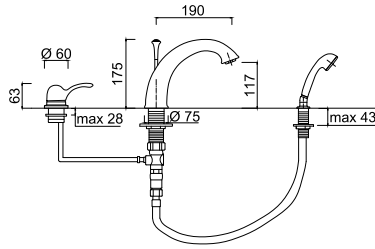
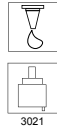

**Monocomando bordo vasca 3 fori, bocca con deviatore**  
 3-hole single-lever mixer for bath's border, spout with diverter.  
 Mitigeur sur gorge à 3 trous, bec avec déviateur.  
 3-Loch Wannenrandmischer, Auslauf mit Umstellung.  
 Monomando baño de repisa con 3 agujeros, caño con desviación.  
 Однорычажный смеситель на 3 отверстия на борт ванны, излив с дивертером.

Articolo	Note	CROMO	CR	BR	O
<b>2665BD</b>		470,00	517,00	705,00*	846,00*

**2659**

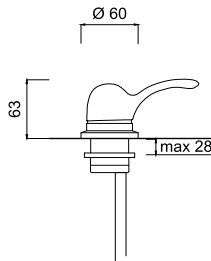

**Monocomando incasso bordo vasca.**  
 Deck mounted mixer.  
 Mitigeur bain-douche sur gorge à encastrer.  
 UP-Einhebel-Wannenrandmischer.  
 Monomando empotrado para bañera de repisa.  
 Смеситель на край ванны

Articolo	Note	CROMO	CR	BR	O
<b>2659</b>		95,00	101,00	137,00	171,00

**NOTE**

**Potete trovare altre soluzioni per la Doccia nell'area WELLNESS.** p.374  
 For additional Shower options please go to WELLNESS section.  
 Pour plus de solutions pour la Douche visitez la section WELLNESS.  
 Für weitere Duschalternativen sehen Sie bitte in dem Kapitel WELLNESS nach.  
 Para más soluciones para Ducha visite la sección WELLNESS.  
 Другие решения для Душа вы найдете в разделе Wellness.



Melody

Эпока



**9405A**

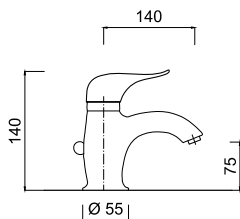

**Monocomando lavabo, scarico 1"1/4 (con flessibile).**  
Wash-basin single-lever mixer, 1"1/4 pop-up waste (with flexible).  
Mitigeur lavabo avec vidage 1"1/4 (avec flexible).  
Einhand-Waschtischbatterie mit Ablaufgarnitur 1"1/4 (mit flexiblen Anschlusschläuchen).  
Monomando lavabo tapón accionado por varilla 1"1/4 (con flexible).  
Однорычажный смеситель для раковины, донный клапан 1"1/4 (гибкая подводка).

Articolo	Note	CROMO			
9405A		133,00			
9305A	EPOCA	133,00			

**9441A**

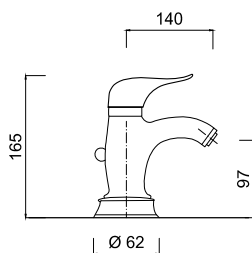

**Monocomando lavabo alto, scarico 1"1/4 (con flessibile).**  
High wash-basin mixer, 1"1/4 pop-up waste (with flexibles).  
Mitigeur lavabo haut, vidage 1"1/4 (avec flexibles).  
Hoher Einhebel-Waschtischmischer, Ablaufgarnitur 1"1/4 (inkl. Anschlusschläuche).  
Monomando lavabo alto, desagüe automatico 1"1/4 (con flex.).  
Высокий смеситель для раковины, донный клапан на 1"1/4 (с гибкими шлангами)

Articolo	Note	CROMO			
9441A		180,00			
9341A	EPOCA	180,00			

**9407A**

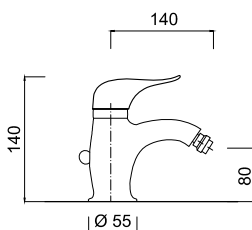

**Monocomando bidet, scarico 1"1/4 (con flessibile).**  
Bidet single-lever mixer, 1"1/4 pop-up waste (with flexible).  
Mélangeur bidet avec vidage 1"1/4 (avec flexible).  
Einhand-Bidetbatterie mit Ablaufgarnitur 1"1/4 (mit flexiblen Anschlusschläuchen).  
Monomando bidet, tapón accionado por varilla 1"1/4 (con flexible).  
Однорычажный смеситель для биде, донный клапан 1"1/4 (гибкая подводка).

Articolo	Note	CROMO			
9407A		133,00			
9307A	EPOCA	133,00			

**9443A**

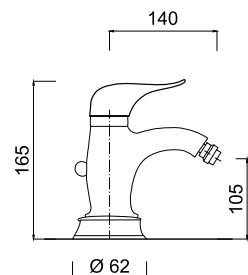

**Monocomando bidet alto, scarico 1"1/4 (con flessibile).**  
High bidet mixer, 1"1/4 pop-up waste (with flexibles).  
Mitigeur bidet haut, vidage 1"1/4 (avec flexibles).  
Hoher Einhebel-Bidetmischer, Ablaufgarnitur 1"1/4 (inkl. Anschlusschläuche).  
Monomando bidet alto, desagüe automatico 1"1/4 (con flex.).  
Высокий смеситель для биде, донный клапан на 1"1/4 (с гибкими шлангами)

Articolo	Note	CROMO			
9443A		180,00			
9343A	EPOCA	180,00			

**9415WB**

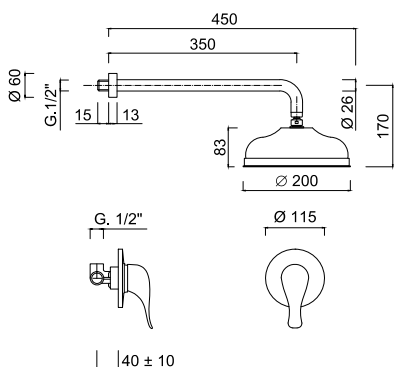

**Set doccia incasso monocomando, soffione ottone**  
Shower built-in single-lever mixer, brass shower head.  
Mitigeur pour douche à encaissement, pomme de douche en laiton.  
Unterputz-Duscheneinhebelmischer mit Kopfbrause, Kopfbrause in Messing.  
Monomando ducha para empotrar, rociador en latón.  
Однорычажный встроенный смеситель для душа, верхний душ из латуны

Articolo	Note	CROMO			
9415WB		326,00			
9315WB	EPOCA	326,00			

**9411KB**

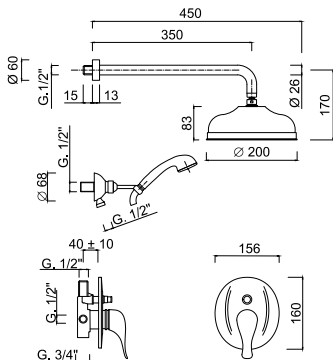

**Set doccia incasso monocomando con deviatore, soffione ottone, kit duplex incasso**

Shower built-in single-lever mixer with diverter, brass shower head, built-in duplex shower kit

Mitigeur pour douche à encaissement avec inverseur, pomme de douche en laiton, ensemble de douche duplex à encaissement

Unterputz- Duscheneinhebelmischer mit Umstellung, Brausekopf in Messing, Einbau- Brauseset Duplex

Monomando ducha para empotrar con desviador, rociador ducha en latón, conjunto ducha duplex para empotrar

Однорычажный встроенный смеситель для душа с дивертером, верхний душ из латуни, встроенный душевой набор "Duplex"

Articolo	Note	CROMO			
9411KB		495,00			
9311KB	EPOCA	495,00			

**9415**

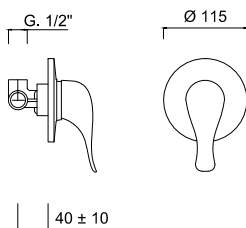

**Monocomando doccia incasso.**

Shower built-in single-lever mixer.

Mitigeur pour douche à encaissement.

Unterputz-Duscheneinhebelmischer.

Monomando ducha para empotrar.

Однорычажный встроенный смеситель для душа.

Articolo	Note	CROMO			
9415		69,00			
9315	EPOCA	69,00			

**9411**

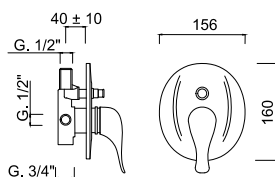

**Monocomando doccia incasso con deviatore.**

Shower built-in single-lever mixer with diverter.

Mitigeur pour douche à encaissement avec inverseur.

Unterputz- Duscheneinhebelmischer mit Umstellung.

Monomando ducha para empotrar con desviador.

Однорычажный встроенный смеситель для душа с дивертером.

Articolo	Note	CROMO			
9411		168,00			
9311	EPOCA	168,00			

**9408WS**

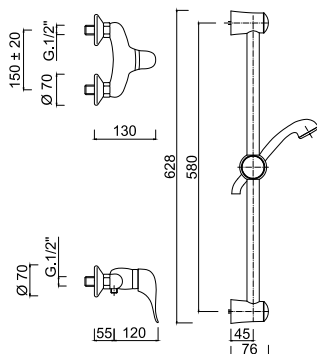

**Monocomando doccia esterno con saliscendi e doccia.**

External single-lever shower mixer with sliding rail set.

Mitigeur extérieur de douche avec barre coulissante et ensemble de douche.

Aufputz- Einhand-Brausebatterie mit Brausestange und Brauseset.

Monomando ducha exterior con conjunto de ducha y barra deslizante

Однорычажный смеситель внешнего монтажа для душа с комплектом штанги для душа.

Articolo	Note	CROMO			
9408WS		205,00			
9308WS	EPOCA	205,00			

**9408**

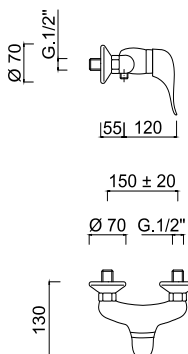

**Monocomando doccia esterno**

External single-lever shower mixer.

Mitigeur pour douche externe.

Aufputz- Einhebelbatterie.

Monomando ducha externo.

Однорычажный смеситель внешнего монтажа для душа.

Articolo	Note	CROMO			
9408		132,00			
9308	EPOCA	132,00			

9408S

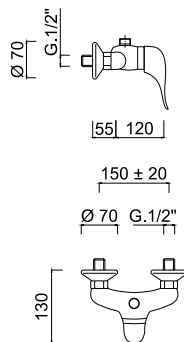

**Monocomando doccia esterno (attacco superiore)**

External single-lever shower mixer (upper connection).

Mitigeur douche (connection supérieure).

Aufputz- Brausemischer (oberer Anschluss).

Misturador para ducha (conexión superior).

Однорычажный смеситель для душа внешнего монтажа (подключение сверху)

Articolo	Note	CROMO			
9408S		132,00			
9308S	EPOCA	132,00			

9401

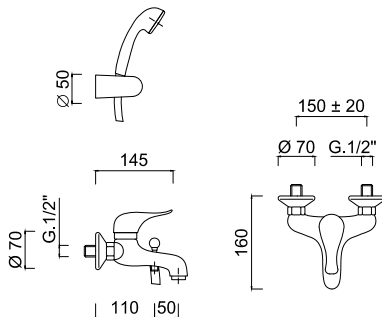

**Monocomando vasca esterno con set doccia duplex.**

External bathtub single-lever mixer with duplex shower kit.

Mitigeur bain/douche extérieur avec ensemble de douche duplex.

Aufputz- Einhebelmischer für die Badewanne mit Brauseset Duplex.

Monomando bañera externo con conjunto de ducha duplex.

Однорычажный смеситель внешнего монтажа для ванны с душевым набором "Duplex"

Articolo	Note	CROMO			
9401		194,00			
9301	EPOCA	194,00			

9465BD

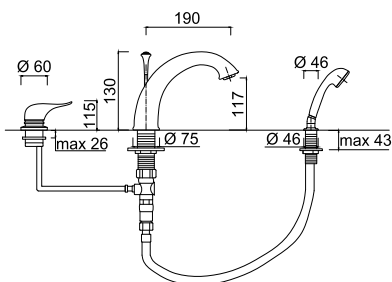

**Monocomando bordo vasca 3 fori, bocca con deviatore**

3-hole single-lever mixer for bath's border, spout with diverter.

Mitigeur sur gorge à 3 trous, bec avec déviateur.

3-Loch Wannenrandmischer, Auslauf mit Umstellung.

Monomando baño de repisa con 3 agujeros, caño con desviación.

Однорычажный смеситель на 3 отверстия на борт ванны, излив с дивертером.

Articolo	Note	CROMO			
9465BD		440,00			
9365BD	EPOCA	440,00			



EPOCA

**NOTE**

Potete trovare altre soluzioni per la Doccia nell'area WELLNESS.

p.374

For additional Shower options please go to WELLNESS section.

Pour plus de solutions pour la Douche visitez la section WELLNESS.

Für weitere Duschalternativen sehen Sie bitte in dem Kapitel WELLNESS nach.

Para más soluciones para Ducha visite la sección WELLNESS.

Другие решения для Душа вы найдете в разделе Wellness.





# Infinito Spazio



**8505A**

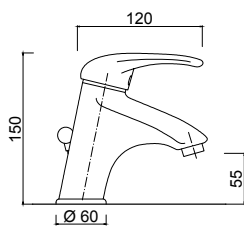

**Monocomando lavabo, scarico 1"1/4 (con flessibile).**  
Wash-basin single-lever mixer, 1"1/4 pop-up waste (with flexible).  
Mitigeur lavabo avec vidage 1"1/4 (avec flexible).  
Einhand-Waschtischbatterie mit Ablaufgarnitur 1"1/4 (mit flexiblen Anschlussschläuchen).  
Monomando lavabo tapón accionado por varilla 1"1/4 (con flexible).  
Однорычажный смеситель для раковины, донный клапан 1"1/4 (гибкая подводка).

Articolo	Note	CROMO			
8505A		138,00			
8605A	SPAZIO	138,00			

**8527A**

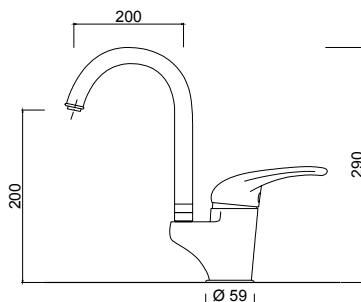

**Monocomando lavabo, bocca girevole, scarico 1"1/4 (con flessibile).**  
Wash-basin mixer, swivel spout, 1"1/4 pop-up waste (with flexible).  
Mitigeur lavabo, bec mobile, vidage automatique 1"1/4 (avec flex.).  
Waschtisch-Einhebelmischer, schwenkbarer Rohrauslauf, 1"1/4 Zugknopf Ablaufgarnitur (mit flexiblen Anschlussschläuchen).  
Monomando lavabo, caño giratorio, tapón accionado por varilla 1"1/4 (con flex.).  
Смеситель для раковины, поворотный излив, донный клапан 1"1/4 (гибкая подводка).

Articolo	Note	CROMO			
8527A		199,00			
8627A	SPAZIO	199,00			

**8507A**

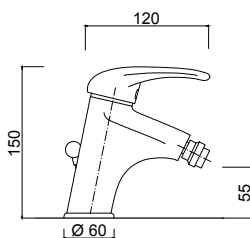

**Monocomando bidet, scarico 1"1/4 (con flessibile).**  
Bidet single-lever mixer, 1"1/4 pop-up waste (with flexible).  
Mélangeur bidet avec vidage 1"1/4 (avec flexible).  
Einhand-Bidetbatterie mit Ablaufgarnitur 1"1/4 (mit flexiblen Anschlussschläuchen).  
Monomando bidet, tapón accionado por varilla 1"1/4 (con flexible).  
Однорычажный смеситель для биде, донный клапан 1"1/4 (гибкая подводка).

Articolo	Note	CROMO			
8507A		138,00			
8607A	SPAZIO	138,00			

**8529A**

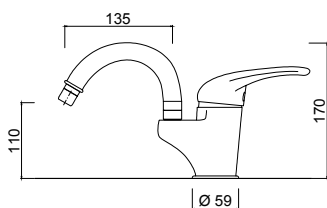

**Monocomando bidet, bocca girevole, scarico 1"1/4 lusso (con flessibile)**  
Bidet mixer, swivel spout, 1"1/4 pop-up waste (with flexible).  
Mitigeur bidet, bec mobile, vidage automatique 1"1/4 (avec flex.).  
Bidet-Einhebelmischer, Rohrauslauf schwenkbarer, 1"1/4 Zugknopf Ablaufgarnitur (mit flexiblen Anschlussschläuchen).  
Monomando bidet, caño giratorio, tapón accionado por varilla 1"1/4 (con flex.).  
Смеситель для биде, поворотный излив, донный клапан 1"1/4 (гибкая подводка).

Articolo	Note	CROMO			
8529A		199,00			
8629A	SPAZIO	199,00			

**8515WB**

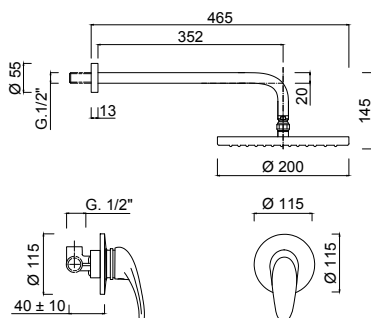
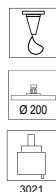

**Set doccia incasso monocomando, soffione ottone**  
Shower built-in single-lever mixer, brass shower head.  
Mitigeur pour douche à encaissement, pomme de douche en laiton.  
Unterputz-Duscheneinhebelmischer, Kopfbrause in Messing.  
Monomando ducha para empotrar, rociador en latón.  
Однорычажный встроенный смеситель для душа, верхний душ из латуни

Articolo	Note	CROMO			
8515WB		319,00			
8615WB	SPAZIO	319,00			

**8511KB**

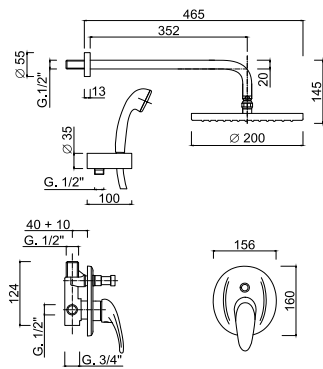
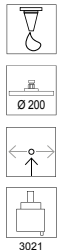

**Set doccia incasso monocomando con deviatore, soffione ottone, kit duplex incasso**

*Shower built-in single-lever mixer with diverter, brass shower head, built-in duplex shower kit*

*Mitigeur pour douche à encaissement avec inverseur, pomme de douche en laiton, ensemble de douche duplex à encaissement*

*Unterputz- Duscheneinhebelmischer mit Umstellung, Brausekopf in Messing, Einbau- Brauseset Duplex*

*Monomando ducha para empotrar con desviador, rociador ducha en latón, conjunto ducha duplex para empotrar*

*Однорычажный встроенный смеситель для душа с дивертером, верхний душ из латуни, встроенный душевой набор "Duplex"*

Articolo	Note	CROMO			
<b>8511KB</b>		484,00			
<b>8611KB</b>	SPAZIO	484,00			

**8515**

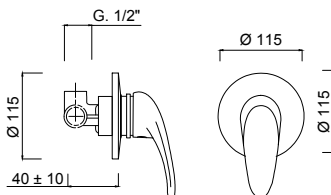

**Monocomando doccia incasso.**

*Shower built-in single-lever mixer.*

*Mitigeur pour douche à encaissement.*

*Unterputz-Duscheneinhebelmischer.*

*Monomando ducha para empotrar.*

*Однорычажный встроенный смеситель для душа.*

Articolo	Note	CROMO			
<b>8515</b>		79,00			
<b>8615</b>	SPAZIO	79,00			

**8511**

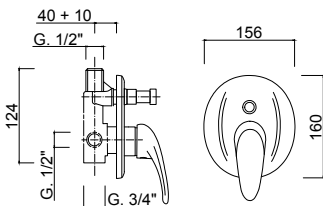
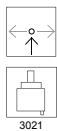

**Monocomando doccia incasso con deviatore.**

*Shower built-in single-lever mixer with diverter.*

*Mitigeur pour douche à encaissement avec inverseur.*

*Unterputz- Duscheneinhebelmischer mit Umstellung.*

*Monomando ducha para empotrar con desviador.*

*Однорычажный встроенный смеситель для душа с дивертером.*

Articolo	Note	CROMO			
<b>8511</b>		164,00			
<b>8611</b>	SPAZIO	164,00			

**8508WS**

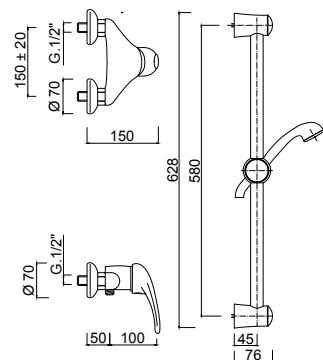

**Monocomando doccia esterno con saliscendi e doccia.**

*External single-lever shower mixer with sliding rail set.*

*Mitigeur extérieur de douche avec barre coulissante et ensemble de douche.*

*Aufputz- Einhand-Brausebatterie mit Brausestange und Brauseset.*

*Monomando ducha exterior con conjunto de ducha y barra deslizante*

*Однорычажный смеситель внешнего монтажа для душа с комплектом штанги для душа.*

Articolo	Note	CROMO			
<b>8508WS</b>		198,00			
<b>8608WS</b>	SPAZIO	198,00			

8508

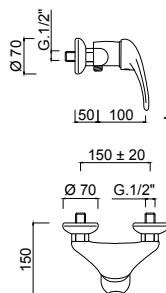

**Monocomando doccia esterno**

*External single-lever shower mixer.*

*Mitigeur pour douche externe.*

*Aufputz- Einhebelbatterie.*

*Monomando ducha externo.*

*Однорычажный смеситель внешнего монтажа для душа.*

Articolo	Note	CROMO			
8508		131,00			
8608	SPAZIO	131,00			

8501

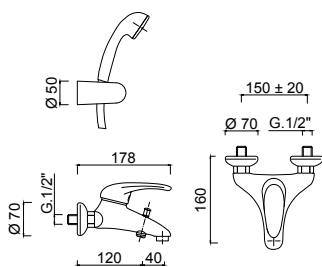

**Monocomando vasca esterno con set doccia duplex.**

*External bathtub single-lever mixer with duplex shower kit.*

*Mitigeur bain/douche extérieur avec ensemble de douche duplex.*

*Aufputz- Einhebelmischer für die Badewanne mit Brauseset Duplex.*

*Monomando bañera externo con conjunto de ducha duplex.*

*Однорычажный смеситель внешнего монтажа для ванны с душевым набором "Duplex"*

Articolo	Note	CROMO			
8501		210,00			
8601	SPAZIO	210,00			



SPAZIO

**NOTE**

**Potete trovare altre soluzioni per la Doccia nell'area WELLNESS.**

*For additional Shower options please go to WELLNESS section.*

*Pour plus de solutions pour la Douche visitez la section WELLNESS.*

*Für weitere Duschalternativen sehen Sie bitte in dem Kapitel WELLNESS nach.*

*Para más soluciones para Ducha visite la sección WELLNESS.*

*Другие решения для Душа вы найдете в разделе Wellness.*

p.374



Goldenlux

GoldenStar





**A420**

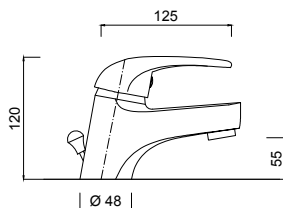

**Monocomando lavabo, scarico 1"1/4 (con flessibile).**  
Wash-basin single-lever mixer, 1"1/4 pop-up waste (with flexible).  
Mitigeur lavabo avec vidage 1"1/4 (avec flexible).  
Einhand-Waschtischbatterie mit Ablaufgarnitur 1"1/4 (mit flexiblen Anschlusschläuchen).  
Monomando lavabo tapón accionado por varilla 1"1/4 (con flexible).  
Однорычажный смеситель для раковины, донный клапан 1"1/4 (гибкая подводка).

Articolo	Note	CROMO			
<b>A420</b>		109,00			
<b>A420M</b>	M	110,00			
<b>A320LC</b>	LC	124,00			
<b>1020A</b>	GSTAR	113,00			

**A421**

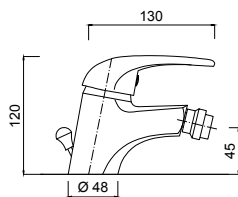

**Monocomando bidet, scarico 1"1/4 (con flessibile).**  
Bidet single-lever mixer, 1"1/4 pop-up waste (with flexible).  
Mélangeur bidet avec vidage 1"1/4 (avec flexible).  
Einhand-Bidetbatterie mit Ablaufgarnitur 1"1/4 (mit flexiblen Anschlusschläuchen).  
Monomando bidet, tapón accionado por varilla 1"1/4 (con flexible).  
Однорычажный смеситель для биде, донный клапан 1"1/4 (гибкая подводка).

Articolo	Note	CROMO			
<b>A421</b>		109,00			
<b>A421M</b>	M	110,00			
<b>A321LC</b>	LC	124,00			
<b>1021A</b>	GSTAR	113,00			

**0415**

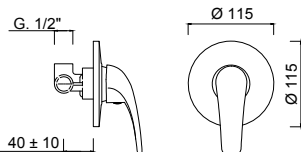

**Monocomando doccia incasso.**  
Shower built-in single-lever mixer.  
Mitigeur pour douche à encaissement.  
Unterputz-Duscheneinhebelmischer.  
Monomando ducha para empotrar.  
Однорычажный встроенный смеситель для душа.

Articolo	Note	CROMO			
<b>0415</b>		76,00			
<b>0415M</b>	M	77,00			
<b>1015</b>	GSTAR	80,00			

**0404**

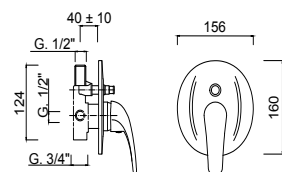
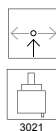

**Monocomando doccia incasso con deviatore.**  
Shower built-in single-lever mixer with diverter.  
Mitigeur pour douche à encaissement avec inverseur.  
Unterputz-Duscheneinhebelmischer mit Umstellung.  
Monomando ducha para empotrar con desviador.  
Однорычажный встроенный смеситель для душа с дивертером.

Articolo	Note	CROMO			
<b>0404</b>		163,00			
<b>0404M</b>	M	164,00			
<b>1004</b>	GSTAR	167,00			

**0414**

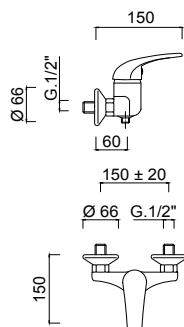

**Monocomando doccia esterno**  
External single-lever shower mixer.  
Mitigeur pour douche externe.  
Aufputz-Einhebelbatterie.  
Monomando ducha externo.  
Однорычажный смеситель внешнего монтажа для душа.

Articolo	Note	CROMO			
<b>0414</b>		110,00			
<b>0414M</b>	M	111,00			
<b>1014</b>	GSTAR	114,00			

0401

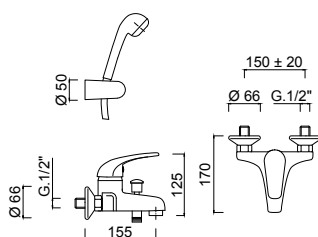

**Monocomando vasca esterno con set doccia duplex.**  
External bathtub single-lever mixer with duplex shower kit.  
Mitigeur bain/douche extérieur avec ensemble de douche duplex.  
Aufputz- Einhebelmischer für die Badewanne mit Brauseset Duplex.  
Monomando bañera externo con conjunto de ducha duplex.  
Однорычажный смеситель внешнего монтажа для ванны с душевым набором "Duplex"

Articolo	Note	CROMO			
0401		163,00			
0401M	M	164,00			
1001	GSTAR	167,00			

0460

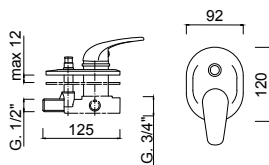

**Centrale con deviatore per bordo vasca.**  
Deck-mounted mixer with diverter  
Mitigeur bain/douche à encastrer avec inverseur.  
Up-Wannenrandmischer mit Umstellung  
Monomando bañera de repisa con desviador.  
Смеситель с девиатором на борт ванны

Articolo	Note	CROMO			
0460		173,00			
0460M	M	174,00			
1060	GSTAR	177,00			



MERY



GOLDENSTAR



LEVA CLINICA

**NOTE**

**Potete trovare altre soluzioni per la Doccia nell'area WELLNESS.** p.374  
For additional Shower options please go to WELLNESS section.  
Pour plus de solutions pour la Douche visitez la section WELLNESS.  
Für weitere Duschalternativen sehen Sie bitte in dem Kapitel WELLNESS nach.  
Para más soluciones para Ducha visite la sección WELLNESS.  
Другие решения для Душа вы найдете в разделе Wellness.

Giada

Giadalux



**2205A**

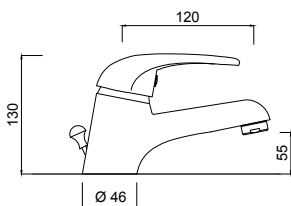

**Monocomando lavabo, scarico 1"1/4 (con flessibile).**  
Wash-basin single-lever mixer, 1"1/4 pop-up waste (with flexible).  
Mitigeur lavabo avec vidage 1"1/4 (avec flexible).  
Einhand-Waschtischbatterie mit Ablaufgarnitur 1"1/4 (mit flexiblen Anschlussschläuchen).  
Monomando lavabo tapón accionado por varilla 1"1/4 (con flexible).  
Однорычажный смеситель для раковины, донный клапан 1"1/4 (гибкая подводка).

Articolo	Note	CROMO			
2205A		88,00			
2105A	GLUX	105,00			
2205ALC	LC	113,00			

**2207A**

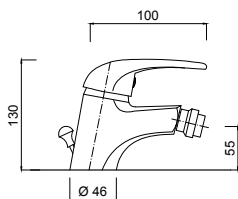

**Monocomando bidet, scarico 1"1/4 (con flessibile).**  
Bidet single-lever mixer, 1"1/4 pop-up waste (with flexible).  
Mitigeur bidet avec vidage 1"1/4 (avec flexible).  
Einhand-Bidetbatterie mit Ablaufgarnitur 1"1/4 (mit flexiblen Anschlussschläuchen).  
Monomando bidet, tapón accionado por varilla 1"1/4 (con flexible).  
Однорычажный смеситель для биде, донный клапан 1"1/4 (гибкая подводка).

Articolo	Note	CROMO			
2207A		88,00			
2107A	GLUX	105,00			
2207ALC	LC	113,00			

**2215WB**

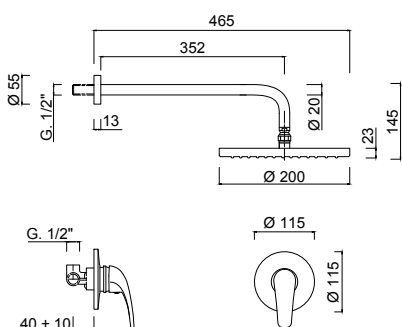
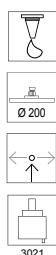

**Set doccia incasso monocomando, soffione Abs**  
Concealed single-lever shower mixer, abs shower head.  
Mitigeur pour douche à encaissement, pomme de douche en abs.  
Unterputz-Duscheneinhebelmischer, Kopfbrause in abs.  
Monomando ducha para empotrar, rociador en abs.  
Однорычажный встроенный смеситель для душа, верхний душ ABS

Articolo	Note	CROMO			
2215WB		195,00			
2115WB	GLUX	199,00			

**2211KB**

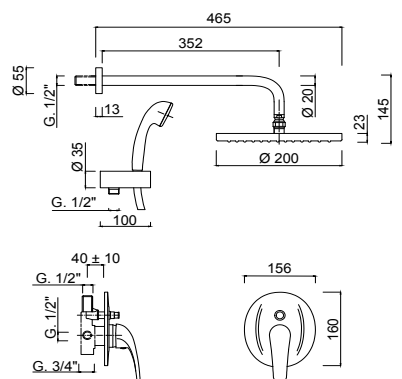

**Set doccia incasso monocomando con deviatore, soffione Abs kit duplex incasso**  
Shower built-in single-lever mixer with diverter, Abs shower head, built-in duplex shower kit  
Mitigeur pour douche à encaissement avec inverseur, pomme de douche en Abs ensemble de douche duplex à encaissement  
Unterputz- Duscheneinhebelmischer mit Umstellung, Brausekopf in Abs Einbau- Brauseset Duplex  
Monomando ducha para empotrar con desviador, rociador ducha en Abs, conjunto ducha duplex para empotrar  
Однорычажный встроенный смеситель для душа с дивертером, верхний душ из ABS, встроенный душевой набор "Duplex"

Articolo	Note	CROMO			
2211KB		330,00			
2111KB	GLUX	334,00			

**2215**

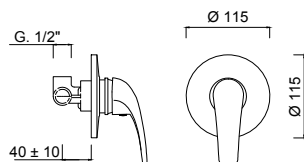

**Monocomando doccia incasso.**  
Shower built-in single-lever mixer.  
Mitigeur pour douche à encaissement.  
Unterputz-Duscheneinhebelmischer.  
Monomando ducha para empotrar.  
Однорычажный встроенный смеситель для душа.

Articolo	Note	CROMO			
2215		67,00			
2115	GLUX	71,00			

2211

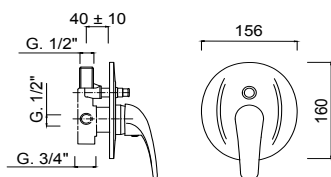
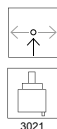

**Monocomando doccia incasso con deviatore.**

Shower built-in single-lever mixer with diverter.  
Mitigeur pour douche à encaissement avec inverseur.  
Unterputz- Duscheneinhebelmischer mit Umstellung.  
Monomando ducha para empotrar con desviador.  
Однорычажный встроенный смеситель для душа с дивертером.

Articolo	Note	CROMO			
2211		154,00			
2111	GLUX	158,00			

2208WS

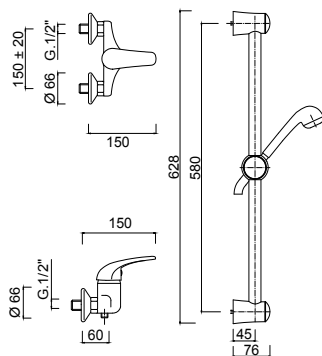

**Monocomando doccia esterno con saliscendi e doccia.**

External single-lever shower mixer with sliding rail set.  
Mitigeur extérieur de douche avec barre coulissante et ensemble de douche.  
Aufputz- Einhand-Brausebatterie mit Brausestange und Brauseset.  
Monomando ducha exterior con conjunto de ducha y barra deslizante  
Однорычажный смеситель внешнего монтажа для душа с комплектом штанги для душа.

Articolo	Note	CROMO			
2208WS		170,00			
2108WS	GLUX	174,00			

2208

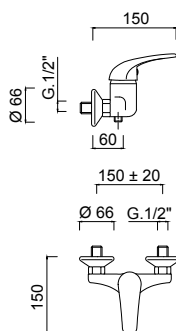

**Monocomando doccia esterno**

External single-lever shower mixer.  
Mitigeur pour douche externe.  
Aufputz- Einhebelbatterie.  
Monomando ducha esterno.  
Однорычажный смеситель внешнего монтажа для душа.

Articolo	Note	CROMO			
2208		91,00			
2108	GLUX	95,00			

2201

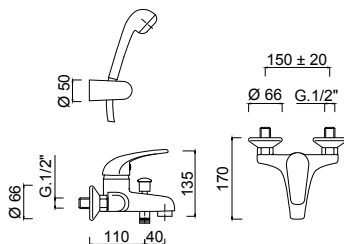

**Monocomando vasca esterno con set doccia duplex.**

External bathtub single-lever mixer with duplex shower kit.  
Mitigeur bain/douche extérieur avec ensemble de douche duplex.  
Aufputz- Einhebelmischer für die Badewanne mit Brauseset Duplex.  
Monomando bañera externo con conjunto de ducha duplex.  
Однорычажный смеситель внешнего монтажа для ванны с душевым набором "Duplex"

Articolo	Note	CROMO			
2201		140,00			
2101	GLUX	144,00			

Vasca - Bath



GIADALUX

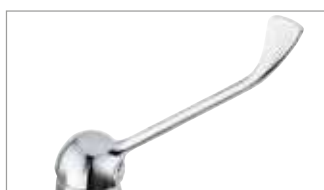

LEVA CLINICA

**NOTE**

Potete trovare altre soluzioni per la Doccia nell'area WELLNESS.

For additional Shower options please go to WELLNESS section.  
Pour plus de solutions pour la Douche visitez la section WELLNESS.  
Für weitere Duschalternativen sehen Sie bitte in dem Kapitel WELLNESS nach.  
Para más soluciones para Ducha visite la sección WELLNESS.  
Другие решения для Душа вы найдете в разделе Wellness.

p.374

700





**A712**

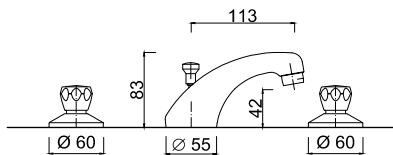

**Batteria lavabo saltarello 1" attacco 1"1/4.**  
Wash-basin set with 1" pop-up waste, 1"1/4 connection.  
Mélangeur lavabo avec vidage automatique 1"1/4  
Waschtisch-Dreilochbatterie mit Ablaufgarnitur 1"1/4  
Bateria lavabo tapón accionado por varilla 1" acometida 1"1/4 .  
Смеситель для раковины с донным клапаном 1"1/4.

Articolo	Note	CROMO			
A712	ORTA	148,00			
A712G	G	148,00			

**0703**

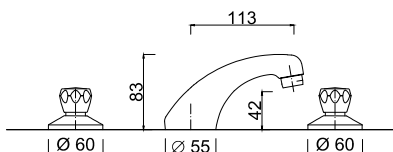

**Batteria lavabo testa cieca.**  
Washbasin set with no pop-up waste and no hole  
Mélangeur lavabo sans vidage et sans trou  
Waschtischarmatur ohne Ablaufgarnitur und ohne Loch  
Bateria lavabo sin desagüe y sin agujero  
Смеситель для раковины

Articolo	Note	CROMO			
A703	ORTA	129,00			
A703G	G	129,00			

**0705**

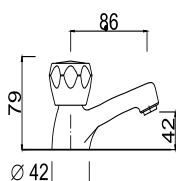

**Rubinetto collo cigno 1/2".**  
1/2" gooseneck tap.  
Robinet col de Cygne 1/2"  
Standventil 1/2"  
Grifo cuello de cisne 1/2".  
Смеситель шейкой лебедя 1/2"

Articolo	Note	CROMO			
0705	ORTA	48,00			
0705G	G	48,00			
0705LC	LC	63,00			

**A755**

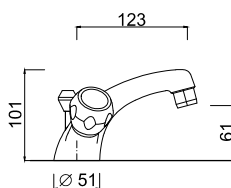

**Monoblocco per lavabo saltarello 1" attacco 1"1/4.**  
Wash-basin unit with 1" pop-up waste, 1"1/4 connection.  
Mélangeur monotrou lavabo avec vidage automatique 1" - fixation 1"1/4  
Waschtisch-Einlochbatterie mit Ablaufgarnitur 1" Anschluss 1"1/4  
Monobloque lavabo tapón accionado por varilla 1" acometida 1"1/4.  
Смеситель для раковины с донным клапаном 1"1/4 (гибкая подводка)

Articolo	Note	CROMO			
A755	ORTA	141,00			
A755G	G	141,00			

**0756**

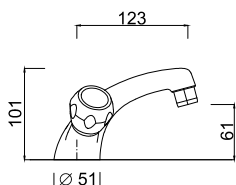

**Monoblocco lavabo testa cieca**  
Blind head wash-basin unit  
Mélangeur monotrou lavabo tête borgne  
Blindkopf-Monoblockmischer für Waschtische  
Monobloque lavabo cabeza ciega  
Смеситель для раковины

Articolo	Note	CROMO			
A756	ORTA	134,00			
A756G	G	134,00			

**A713**



**Batteria bidet saltarello 1" attacco 1"1/4.**

Bidet unit with 1" pop-up waste, 1"1/4 connection.  
Mélangeur bidet avec vidage automatique 1"1/4  
Bidet-Dreilochbatterie mit Ablaufgarnitur 1"1/4  
Monobloque bidet tapón accionado por varilla 1" acometida 1"1/4.  
Смеситель для биде с донным клапаном 1"1/4, на 3 отверстия.

Articolo	Note	CROMO			
<b>A713</b>	ORTA	109,00			
<b>A713G</b>	G	109,00			

**A757**

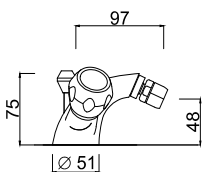

**Monoblocco bidet saltarello 1" attacco 1"1/4.**

Bidet unit with 1" pop-up waste, 1"1/4 connection.  
Mélangeur monotrou bidet avec vidage automatique 1" - fixation 1"1/4  
Bidet-Einlochbatterie mit Ablaufgarnitur 1" Anschluss 1"1/4  
Monobloque bidet tapón accionado por varilla 1" acometida 1"1/4.  
Смеситель для биде с донным клапаном 1"1/4 (гибкая подводка).

Articolo	Note	CROMO			
<b>A757</b>	ORTA	142,00			
<b>A757G</b>	G	147,00			

**0758**

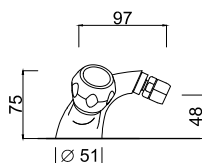

**Monoblocco bidet testa cieca**

Blind head bidet unit  
Mélangeur monotrou bidet tête borgne  
Blindkopf-Monoblockmischer für Bidet  
Monobloque bidet cabeza ciega  
Смеситель для биде

Articolo	Note	CROMO			
<b>A758</b>	ORTA	134,00			
<b>A758G</b>	G	134,00			

**0725**

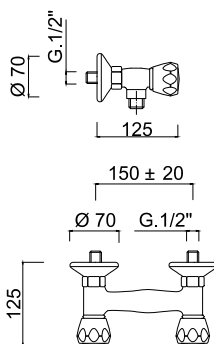

**Gruppo per doccia esterno senza flessibile.**

External shower without flexible.  
Douche extérieur sans flexible.  
Brausebatterie ohne flexiblen Anschlussschlauchen.  
Grupo ducha externo sin flexible.

Articolo	Note	CROMO			
<b>0725</b>	ORTA	79,00			
<b>0725G</b>	G	79,00			

**0700**

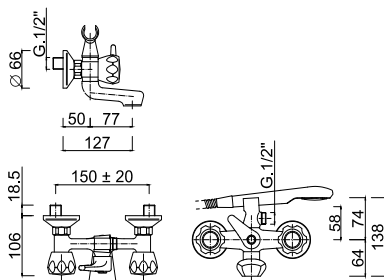

**Gruppo vasca esterno con doccia.**

External bathtub set with shower.  
Mélangeur bain-douche extérieur avec douchette  
Wannenbatterie mit Schlauch-Handbrause nu verstellbarem  
Grupo bañera externo con ducha.  
Внешний смеситель для ванны с душевой лейкой.

Articolo	Note	CROMO			
<b>0700</b>	ORTA	156,00			
<b>0700G</b>	G	156,00			

0701

**Gruppo vasca esterno con doccia duplex.**  
External bathtub set with duplex shower.  
Mélangeur bain-douche extérieur avec douchette duplex.  
Wannenbatterie mit Schlauch-Handbrause nu verstellbarem Wandhalter.  
Grupo bañera externo con ducha duplex.  
Внешний смеситель для ванны с душем.

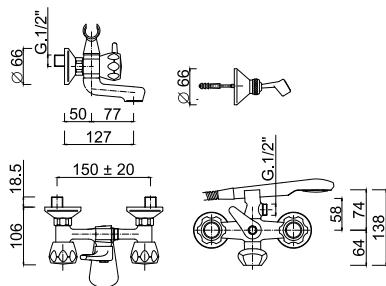

Articolo	Note	CROMO			
0701	ORTA	160,00			
0701G	G	160,00			

0730

**Rubinetto per lavatrice 1/2" - 3/8".**  
1/2" - 3/8" tap for washing-machine.  
Robinet pour la machine à laver 1/2" - 3/8"  
1/2" - 3/8" Waschmaschinenhahn  
Grifo para lavadora 1/2" - 3/8".  
Смеситель для стиральной машины 1/2" - 3/8"

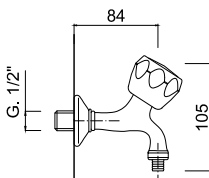

Articolo	Note	CROMO			
0730	ORTA	47,00			
0730G	G	47,00			

0707

**Gruppo lavello attacco lavatrice.**  
Sink set with connection for washing machine.  
Mélangeur évier avec enclenchement pour machine à laver  
Spueltischbatterie mit Anschluss für die Geschirrwassmaschine  
Grupo fregadero acometida lavadora.  
Смеситель для раковины с соединителем для стиральной машины.

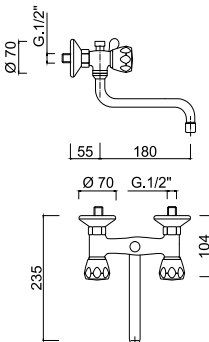

Articolo	Note	CROMO			
0707	ORTA	127,00			
0707G	G	127,00			

0731

**Rubinetto prolungato 1/2" .**  
1/2" extended tap.  
Robinet rallongé 1/2"  
1/2" Verlängerter Hahn  
Grifo alargado 1/2".  
Продолговатый смеситель 1/2".

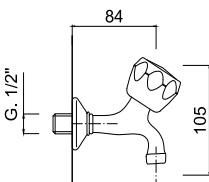

Articolo	Note	CROMO			
0731	ORTA	36,00			
0731G	G	36,00			
0731LC	LC	51,00			

0729

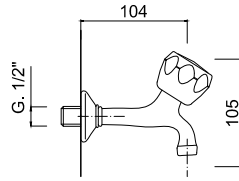

**Rubinetto prolungatissimo 1/2" .**  
1/2" extended tap.  
Robinet rallongé 1/2"  
1/2" Verlänger Hahn  
Grifo alargado 1/2" .  
Продолговатый смеситель 1/2" .

Articolo	Note	CROMO			
0729	ORTA	45,00			
0729G	G	45,00			

0732

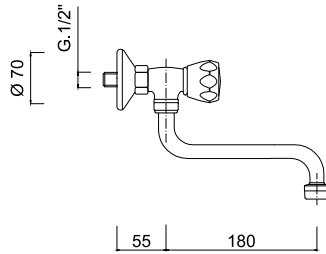

**Rubinetto a snodo 1/2" .**  
1/2" swivel tap.  
Robinet vertical 1/2"  
Auslaufventil 1/2"  
Grifo con articulación 1/2" .  
Смеситель с шарнирным соединением 1/2" .

Articolo	Note	CROMO			
0732	ORTA	43,00			
0732G	G	43,00			
0732LC	LC	58,00			

0738

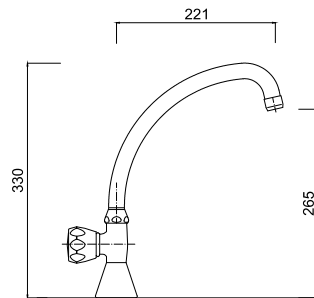

**Rubinetto a colonna.**  
Pillar type tap.  
Robinet à colonne  
Standventil Hahn  
Grifo de columna.  
Смеситель колонна

Articolo	Note	CROMO			
0738	ORTA	59,00			
0738G	G	59,00			
0738LC	LC	74,00			

0716

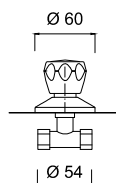

**Rubinetto incasso 1/2" .**  
1/2" built-in tap.  
Robinet à encaissement 1/2"  
UP-Ventil 1/2"  
Grifo para empotrar 1/2"  
Вентиль встроенный 1/2" .

Articolo	Note	CROMO			
0716	ORTA	41,00			
0716G	G	41,00			

0719

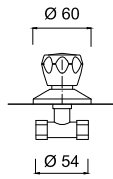

**Rubinetto incasso 3/4".**  
3/4" built-in tap.  
Robinet à encaissement 3/4".  
UP-Ventil 3/4".  
Grifo para empotrar 3/4".

Articolo	Note	CROMO			
0719	ORTA	47,00			
0719G	G	47,00			

0704

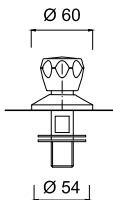

**Rubinetto bidet 1/2".**  
Bidet 1/2" tap.  
Robinet bidet 1/2"  
1/2" Hahn für Bidet  
Grifo bidet 1/2".  
Смеситель для биде 1/2"

Articolo	Note	CROMO			
0704	ORTA	35,00			
0704G	G	35,00			

**NOTE**

**Potete trovare altre soluzioni per la Doccia nell'area WELLNESS.**

**p.374**

For additional Shower options please go to WELLNESS section.  
Pour plus de solutions pour la Douche visitez la section WELLNESS.  
Für weitere Duschalternativen sehen Sie bitte in dem Kapitel WELLNESS nach.  
Para más soluciones para Ducha visite la sección WELLNESS.  
Другие решения для Душа вы найдете в разделе Wellness.



**ORTA**



**MINERVA MINI**



**LEVA CLINICA**









GIULINI G.









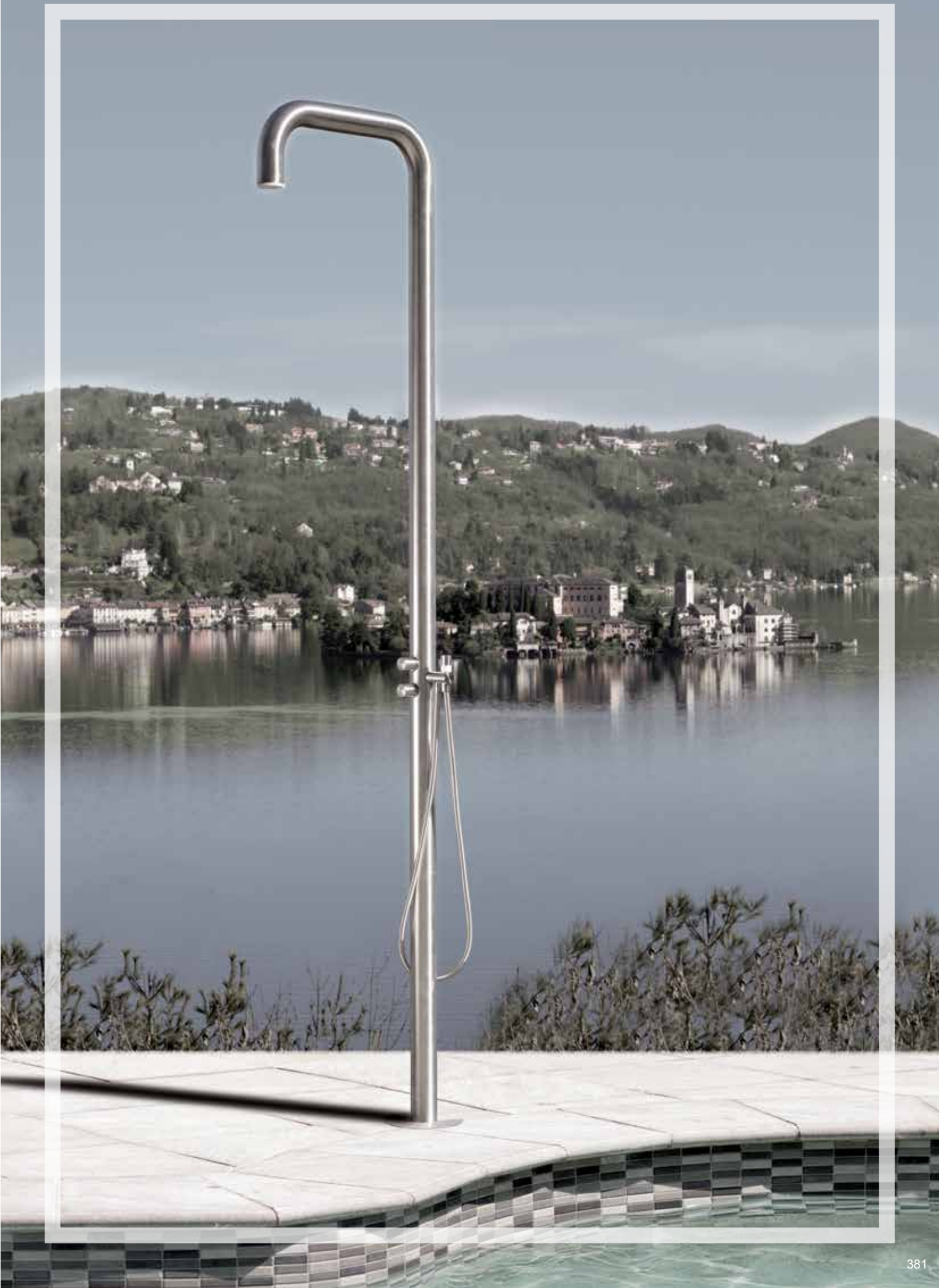

1630

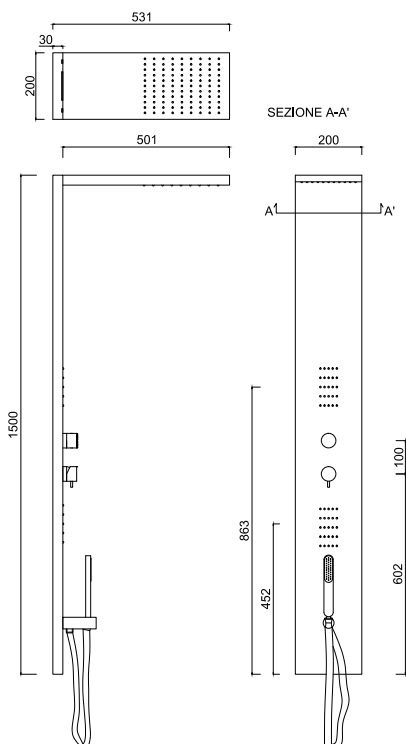

**Completo colonna doccia esterna monocomando, soffione pioggia, kit duplex, soffioncini frontali**

Complete shower column with single-lever mixer, shower head with rain flow, duplex shower kit, frontal body sprays.

Colonne de douche complète avec mitigeur, ciel de pluie avec jet à pluie, ensemble de douche duplex, douchettes frontales.

Komplette Standbrause mit Duscheneinhebelmischer, Kopfbrause mit Regendusche, Brauseset Duplex, Körperbrausen.

Columna ducha completa con monomando, rociador a techo con chorro lluvia, conjunto de ucha dúplex, duchas frontales.

Цельная душевая колонна с однорычажным смесителем, верхний душ с функцией дождя, душевой набор "Duplex", фронтальные боковые форсунки.

Articolo	Note	CROMO	BO-NO-NKO	BR	O
1630		1.495,00	•	•	•

1631

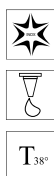
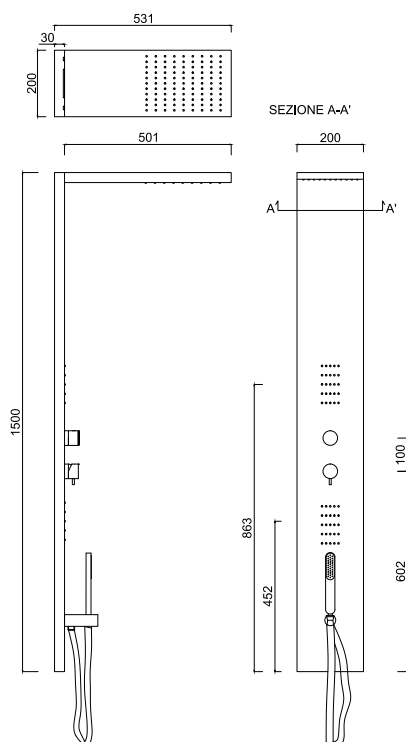

**Completo colonna doccia esterna termostatico, soffione pioggia, kit duplex, soffioncini frontali**

Complete shower column with thermostatic mixer, shower head with rain flow, duplex shower kit, frontal body sprays.

Colonne de douche complète avec mitigeur thermostatique, ciel de pluie avec jet à pluie, ensemble de douche duplex, douchettes frontales.

Komplette Standbrause mit Einhebelthermostatbatterie, Kopfbrause mit Regendusche, Brauseset Duplex, Körperbrausen.

Columna ducha completa con mezclador termostatico, rociador a techo con chorro lluvia, conjunto de ducha dúplex, duchas frontales.

Цельная душевая колонна с термостатическим смесителем, верхний душ с функцией дождя, душевой набор "Duplex", фронтальные боковые форсунки.

Articolo	Note	CROMO	BO-NO-NKO	BR	O
1631		1.730,00	•	•	•



1632

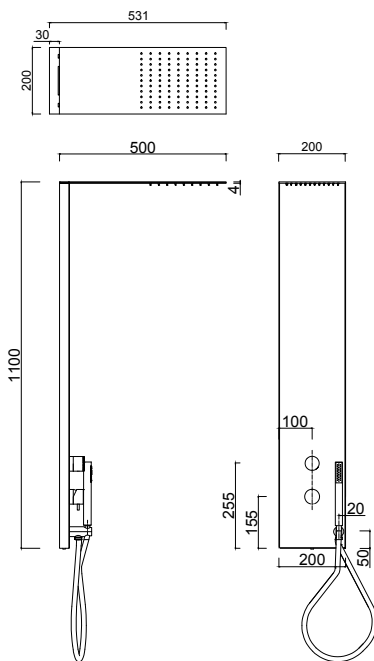

**Completo colonna doccia esterna monocomando, soffione pioggia, kit duplex.**

Complete shower column with single-lever mixer, shower head with rain flow, duplex shower kit.

Colonne de douche complète avec mitigeur, ciel de pluie avec jet à pluie, ensemble de douche duplex.

Komplette Standbrause mit Duscheneinhebelmischer, Kopfbrause mit Regendusche, Brauseset Duplex.

Columna ducha completa con monomando, rociador a techo con chorro lluvia, conjunto de ducha dúplex.

Цельная душевая колонна с однорычажным смесителем, верхний душ с функцией дождя, душевой набор "Duplex".

Articolo	Note	CROMO	BO-NO-NKO	BR	O
1632		950,00	1.650,00	•	•

1632T

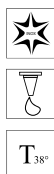
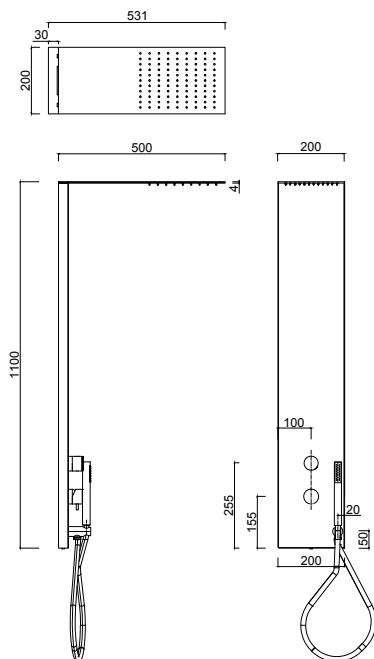

**Completo colonna doccia esterna termostatico, soffione pioggia, kit duplex.**

Wall-mounted thermostatic shower column with rainfall jet and duplex shower kit.

Colonne de douche thermostatique complète avec ciel de pluie et ensemble de douche.

AP-Duschsystem mit Thermostat, Regendusche und Brauseset.

Columna de ducha termostática de superficie con rociador chorro lluvia y kit de ducha.

Комплект душевой колонны, термостат, душевая лейка с эффектом дождя и душевой комплект

Articolo	Note	CROMO	BO-NO-NKO	BR	O
1632T		1.510,00	•	•	•

1634

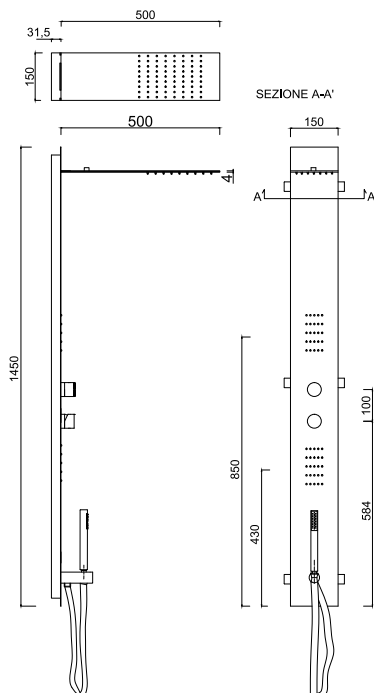

**Colonna doccia INCASSO con monocomando, soffione pioggia, set doccia.**

*Concealed shower column, single lever mixer, rainfall jet, shower kit.  
Colonne de douche à encastrer avec mitigeur, ciel de pluie, ensemble de douche.*

*UP-Duschsäule mit Einhebelmischer, Regendusche, Brauseset.  
Columna de ducha empotrada con mezclador monomando, rociador chorro lluvia, kit de ducha.*

*Встроенная душевая колонна с однорычажным смесителем, душевая лейка с эффектом дождя и душевой набор.*

Articolo	Note	CROMO	BO-NO-NKO	BR	O
1634		1.630,00	•	•	•

1634T

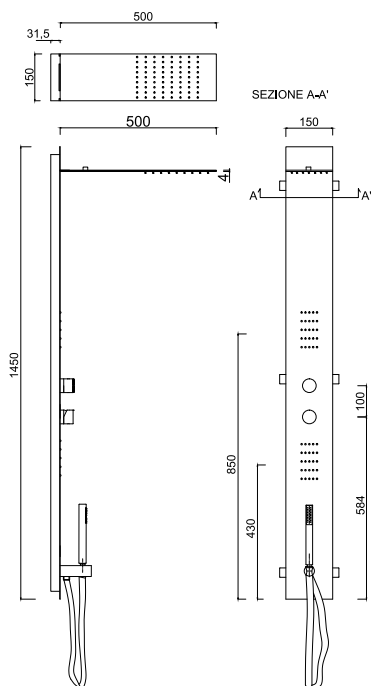

**Colonna doccia INCASSO TERMOSTATICA, soffione pioggia, set doccia.**

*Concealed shower column, thermostatic mixer, rainfall jet, shower kit.  
Colonne de douche thermostatique à encastrer, ciel de pluie, ensemble de douche.*

*UP-Thermostat-Duschsäule, Regendusche, Brauseset.  
Columna de ducha termostática empotrada, rociador chorro lluvia, kit de ducha.*

*Встроенная душевая колонна с термостатом, душевая лейка с эффектом дождя и душевой набор.*

Articolo	Note	CROMO	BO-NO-NKO	BR	O
1634T		1.920,00	•	•	•

1640

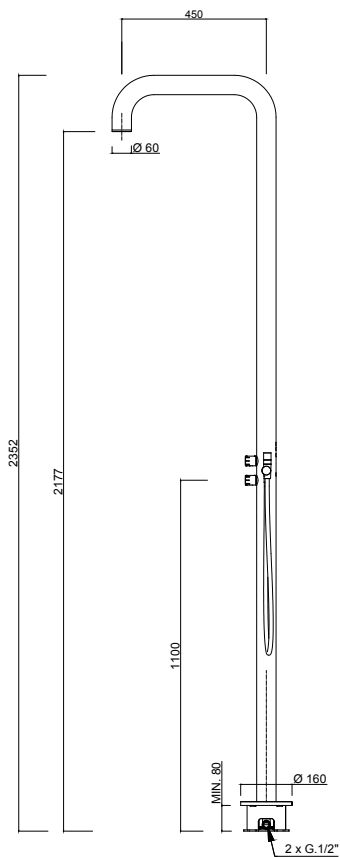

**Colonna doccia da terra, miscelatore, sistema incasso ispezionabile.**

*Free-standing shower column, single lever mixer, inspectable floor-mounted box.*

*Colonne de douche à fixation au sol, mitigeur, boîte d'encastrement au sol inspectable.*

*Duschsäule mit Bodenbefestigung, Einhebelmischer, inspizierbare Einbaubox.*

*Column de ducha para fijación al suelo, mezclador monomando, caja empotrada en el suelo inspeccionable.*

*Напольная душевая колонна, однорычажный смеситель, инспекционируемая встроенная часть.*

Articolo	Note	INL	BO-NO-NKO	BR	O
1640		4.490,00	•	•	•

1640M

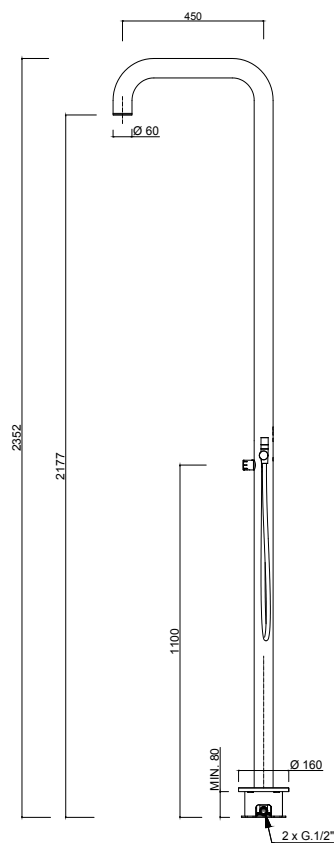

**Colonna doccia da terra, monoacqua**

*Free standing shower column for pre-mixed water.*

*Colonne de douche à fixation au sol, pour eau pré-mélangée.*

*Duschsäule mit Bodenbefestigung für vorgemischtes Wasser.*

*Column de ducha para fijación al suelo, para agua premezclada.*

*Напольная душевая колонна, без смесителя.*

Articolo	Note	INL	BO-NO-NKO	BR	O
1640M		2.950,00	•	•	•

**9815WB-25**

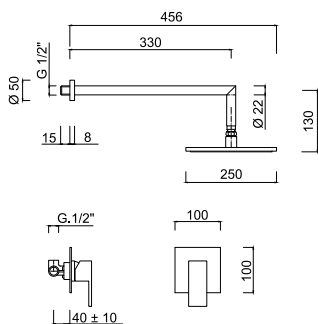

**Set doccia incasso monocomando, soffione ottone**  
Shower built-in single-lever mixer, brass shower head.  
Mitigeur pour douche à encaissement, pomme de douche en laiton.  
Unterputz-Duscheneinhebelmischer mit Kopfbrause, Kopfbrause in Messing.  
Monomando ducha para empotrar, rociador en latón.  
Однорычажный встроенный смеситель для душа, верхний душ из латуни

Articolo	Note	CROMO	BO-NO-NKO		
9815WB-25		525,00	732,00		

**9813KB-25**

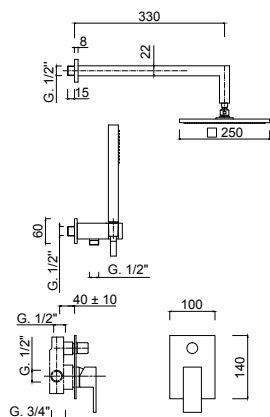

**Set doccia incasso monocomando con deviatore, soffione ottone, kit duplex incasso**  
Shower built-in single-lever mixer with diverter, brass shower head, built-in duplex shower kit  
Mitigeur pour douche à encaissement avec inverseur, pomme de douche en laiton, ensemble de douche duplex à encaissement  
Unterputz-Duscheneinhebelmischer mit Umstellung, Brausekopf in Messing, Einbau-Brauseset Duplex  
Monomando ducha para empotrar con desviador, rociador ducha en latón, conjunto ducha duplex para empotrar  
Однорычажный встроенный смеситель для душа с дивертером, верхний душ из латуни, встроенный душевой набор "Duplex"

Articolo	Note	CROMO	BO-NO-NKO		
9813WB-25		730,00	1.121,00		

**9813-3KS2**

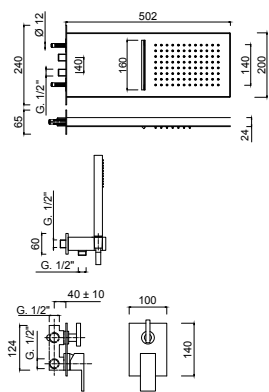

**Set doccia incasso monocomando con deviatore 3 vie, set doccia incasso, soffione cascata/pioggia.**  
Built-in shower mixer with 3-way diverter, built-in shower kit, waterfall/rainfall showerhead.  
Mitigeur douche à encastrer avec inverseur à 3 sorties, ensemble de douche à encastrer, douche de tête avec jets cascade et pluie.  
UP-Einhebel-Brausemischer mit 3-Wege-Umstellung, Unterputz-Brauseset, Kopfbrause mit Wasserfall/Regenstrahl.  
Conjunto monomando ducha empotrado con inversor 3 vías, kit de ducha empotrado, rociador cascada/lluvia.  
Встраиваемый смеситель для душа с дивертером на 3 выхода, встраиваемый душевым набором, верхним душем с функциями каскада и дождя

Articolo	Note	CROMO	BO-NO-NKO		
9813-3KS2		1.139,00	•		

**9808-12WSQ**

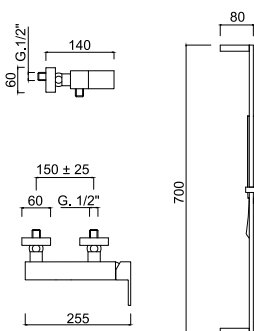

**Monocomando doccia esterno con saliscendi e doccia.**  
External single-lever shower mixer with sliding rail set.  
Mitigeur extérieur de douche avec barre coulissante et ensemble de douche.  
Aufputz-Einhand-Brausebatterie mit Brausestange und Brauseset.  
Monomando ducha exterior con conjunto de ducha.  
Однорычажный смеситель внешнего монтажа для душа с комплектом штанги для душа

Articolo	Note	CROMO	BO-NO-NKO		
9808-12WSQ		489,00	878,00		

**9808WC-SQ**

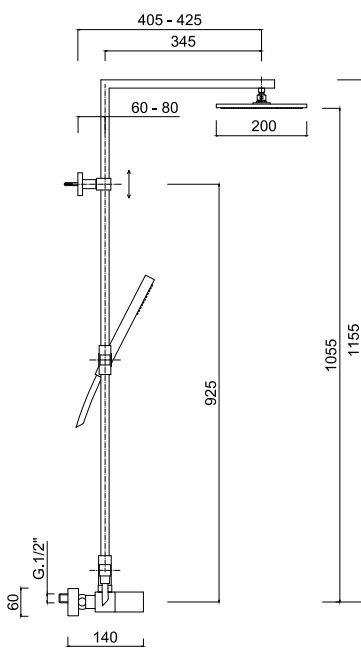

**Colonna doccia esterna monocomando, set doccia, soffione in ottone**

External single-lever shower mixer with shower column, shower kit, brass shower head.

Mitigeur de douche avec colonne de douche, ensemble de douche, pomme de douche en laiton.

Brausemischer mit Säulenbrause, Brauseset, Kopfbrause in Messing. Monomando con columna para ducha, conjunto de ducha, rociador en latón.

Однорычажный смеситель для душа внешнего монтажа с душевой колонной, душевой набор, верхний душ из латуни.

Articolo	Note	CROMO	BO-NO-NKO		
9808WC-SQ		1.074,00	•		

**8301-20**

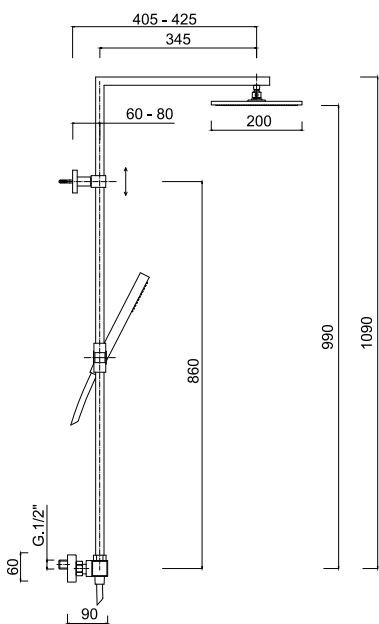
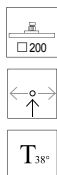

**Colonna doccia esterna termostatica, set doccia, soffione in ottone**

External thermostatic shower column, shower kit, brass shower head

Colonne de douche avec mélangeur thermostatique, ensemble de douche, pomme de douche en laiton

Aufputz- Standbrause mit Thermostat-Brausebatterie, Brauseset, Kopfbrause in Messing

Columna ducha con mezclador termostático, conjunto de ducha, rociador ducha en latón

Термостатическая душевая колонна внешнего монтажа, душевой набор, верхний душ из латуни

Articolo	Note	CROMO	BO-NO-NKO		
8301-20		1.029,00	•		

**6515WB-25**

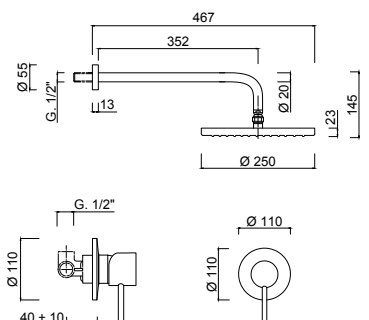
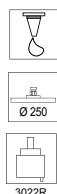

**Set doccia incasso monocomando, soffione ottone**

Shower built-in single-lever mixer, brass shower head.

Mitigeur pour douche à encaissement, pomme de douche en laiton.

Unterputz-Duscheneinhebelmischer mit Kopfbrause, Kopfbrause in Messing.

Monomando ducha para empotrar, rociador en latón.

Однорычажный встроенный смеситель для душа, верхний душ из латуни

Articolo	Note	CROMO	BO-NO-NKO		
6515WB-25		420,00	645,00		

**6513KB-25**

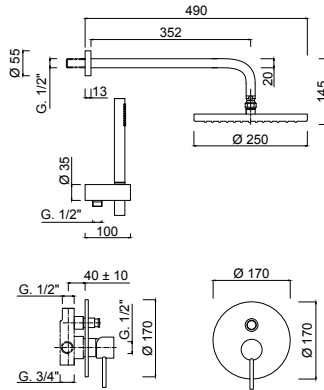

**Set doccia incasso monocomando con deviatore, soffione ottone, kit duplex incasso**  
 Shower built-in single-lever mixer with diverter, brass shower head, built-in duplex shower kit  
 Mitigeur pour douche à encaissement avec inverseur, pomme de douche en laiton, ensemble de douche duplex à encaissement  
 Unterputz- Duscheneinhebelmischer mit Umstellung, Brausekopf in Messing, Einbau- Brauseset Duplex  
 Monomando ducha para empotrar con desviador, rociador ducha en latón, conjunto ducha duplex para empotrar  
 Однорычажный встроенный смеситель для душа с дивертером, верхний душ из латуни, встроенный душевой набор "Duplex"

Articolo	Note	CROMO	BO-NO-NKO		
6513KB-25		605,00	990,00		

**6513-3-25KBS**

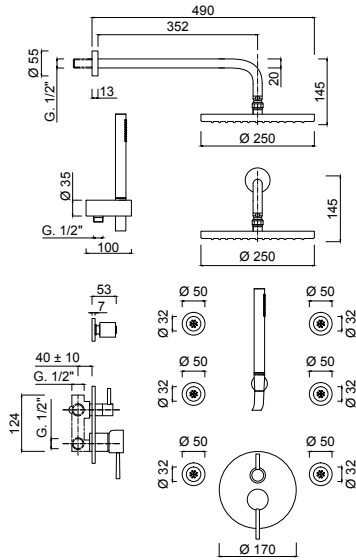

**Set doccia incasso monocomando con deviatore 3 uscite, soffione ottone, kit duplex incasso, 6 soffioncini incasso laterali.**  
 Built-in shower mixer with 3-ways diverter, brass showerhead, built-in duplex shower kit, 6 built-in body sprays.  
 Mitigeur douche à encaissement avec inverseur à 3 sorties, pomme de douche en laiton, ensemble de douche duplex à encaissement, 6 douchettes latérales murales.  
 UP-Einhebel-Brausemischer mit 3-Wege-Umstellung, Kopfbrause aus Messing, UP-Brauseset, 6 Körperbrausen.  
 Monomando ducha empotrado con inversor 3 vías, rociador en latón, kit de ducha, 6 jets laterales empotrados.  
 Встраиваемый смеситель для душа с дивертером на 3 выхода, верхний душ из латуни, встраиваемый душевой набор "Duplex", 6 встраиваемых боковых форсунок.

Articolo	Note	CROMO	BO-NO-NKO		
6513-3-25KBS		999,00	•		

**6508-01WS**

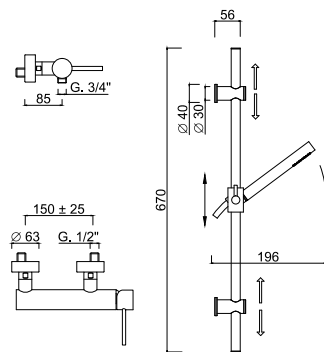

**Monocomando doccia esterno con saliscendi e doccia.**  
 External single-lever shower mixer with sliding rail set.  
 Mitigeur extérieur de douche avec barre coulissante et ensemble de douche.  
 Aufputz- Einhand-Brausebatterie mit Brausestange und Brauseset.  
 Monomando ducha exterior con conjunto de ducha.  
 Однорычажный смеситель внешнего монтажа для душа с комплектом штанги для душа.

Articolo	Note	CROMO	BO-NO-NKO		
6508-01WS		372,00	707,00		

**6508SWC-S**

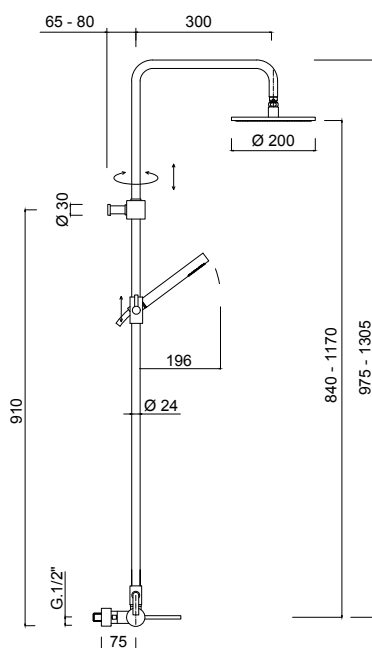

**Colonna doccia esterna monocomando, set doccia, soffione in ottone**

External single-lever shower mixer with shower column, shower kit, brass shower head.

Mitigeur de douche avec colonne de douche, ensemble de douche, pomme de douche en laiton.

Brausemischer mit Säulenbrause, Brauseset, Kopfbrause in Messing. Monomando con columna para ducha, conjunto de ducha, rociador en latón.

Однорычажный смеситель для душа внешнего монтажа с душевой колонной, душевой набор, верхний душ из латуни.

Articolo	Note	CROMO	BO-NO-NKO		
6508WSC-S		835,00	•		

**8224WC-SX**

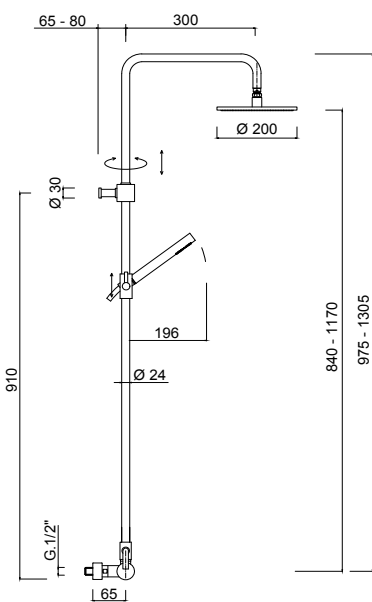

**Colonna doccia esterna termostatica, set doccia, soffione in Inox**

External thermostatic shower column, shower kit, Inox shower head  
Colonne de douche avec mélangeur thermostatique, ensemble de douche, pomme de douche en Inox

Aufputz- Standbrause mit Thermostat-Brausebatterie, Brauseset, Kopfbrause in Inox

Columna ducha con mezclador termostático, conjunto de ducha, rociador ducha en Inox

Термостатическая душевая колонна внешнего монтажа, душевой набор, верхний душ из Inox

Articolo	Note	CROMO	BO-NO-KNO		
8224WC-SX	INOX	666,00	•		
8224WC-S	OT	721,00	•		
8224WC-SA	ABS	617,00	•		

## 8225WC-SX

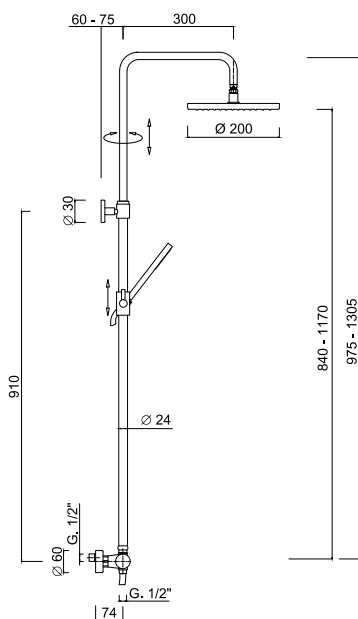

### Colonna doccia esterna termostatica, set doccia, soffione in Inox

External thermostatic shower column, shower kit, Inox shower head  
Colonne de douche avec mélangeur thermostatique, ensemble de douche, pomme de douche en Inox  
Aufputz- Standbrause mit Thermostat-Brausebatterie, Brauseset, Kopfbrause in Inox  
Columna ducha con mezclador termostático, conjunto de ducha, rociador ducha en Inox  
Термостатическая душевая колонна внешнего монтажа, душевой набор, верхний душ из Inox

Articolo	Note	CROMO	BO-NO-KNO		
8225WC-SX	INOX	605,00	•		
8225WC-S	OT	660,00	•		
8225WC-SA	ABS	555,00	•		

## 7515WB

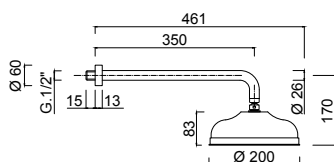

### Set doccia incasso monocomando, soffione ottone

Shower built-in single-lever mixer, brass shower head.  
Mitigeur pour douche à encaissement, pomme de douche en laiton.  
Unterputz-Duscheneinhebelmischer mit Kopfbrause, Kopfbrause in Messing.  
Monomando ducha para empotrar, rociador en latón.  
Однорычажный встроенный смеситель для душа, верхний душ из латуни

Articolo	Note	CROMO	AR-BR	O	
7515WB		336,00	450,00	533,00	
7515WBL	L	342,00	456,00	539,00	
7515WBCE	CE	346,00	460,00	543,00	
7515WB/S	S	386,00	500,00	583,00	

## 7511KB

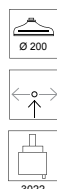
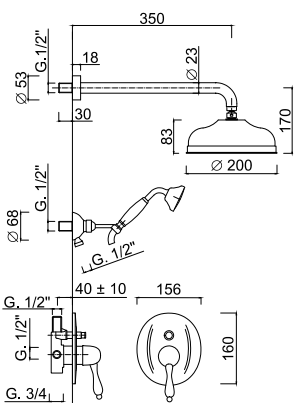

### Set doccia incasso monocomando con deviatore, soffione ottone, kit duplex incasso

Shower built-in single-lever mixer with diverter, brass shower head, built-in duplex shower kit  
Mitigeur pour douche à encaissement avec inverseur, pomme de douche en laiton, ensemble de douche duplex à encaissement  
Unterputz- Duscheneinhebelmischer mit Umstellung, Brausekopf in Messing, Einbau- Brauseset Duplex  
Monomando ducha para empotrar con desviador, rociador ducha en latón, conjunto ducha duplex para empotrar  
Однорычажный встроенный смеситель для душа с дивертером, верхний душ из латуни, встроенный душевой набор "Duplex"

Articolo	Note	CROMO	AR-BR	O	
7511KB		567,00	800,00	991,00	
7511KBL	L	573,00	806,00	997,00	
7511KBCE	CE	598,00	831,00	1.022,00	
7511KB/S	S	617,00	850,00	1.041,00	



**7524WS**

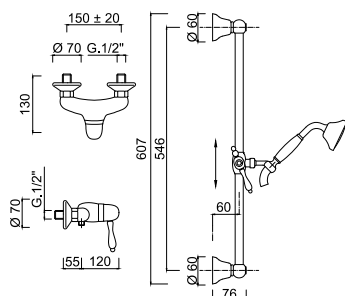

**Monocomando doccia esterno con saliscendi e doccia.**

*Single-lever shower mixer with sliding rail set.*

*Mitigeur douche mural avec barre coulissante et ensemble de douche.*

*Aufputz- Einhebelbrausebatterie mit Brausestange und Brauseset.*

*Monomando ducha exterior con conjunto ducha.*

*Однорычажный смеситель для душа с комплектом штанги для душа.*

Articolo	Note	CROMO	AR-BR	O
<b>7524WS</b>		420,00	599,00	772,00
<b>7524WSL</b>	L	432,00	621,00	784,00
<b>7524WSCE</b>	CE	461,00	640,00	813,00
<b>7524WS/S</b>	S	520,00	699,00	872,00

**7524SWC-S**

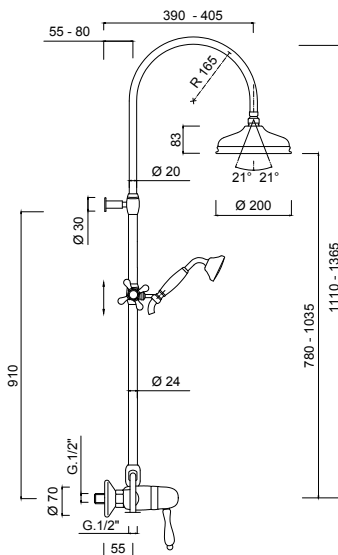

**Colonna doccia esterna monocomando, set doccia, soffione in ottone**

*External single-lever shower mixer with shower column, shower kit, brass shower head.*

*Mitigeur de douche avec colonne de douche, ensemble de douche, pomme de douche en laiton.*

*Brausemischer mit Säulenbrause, Brauseset, Kopfbrause in Messing.*

*Monomando con columna para ducha, conjunto de ducha, rociador en latón.*

*Однорычажный смеситель для душа внешнего монтажа с душевой колонной, душевой набор, верхний душ из латуни.*

Articolo	Note	CROMO	AR-BR	O
<b>7524SWC-S</b>		878,00	1.113,00	1.272,00
<b>7524SWC-SL</b>	L	884,00	1.119,00	1.278,00
<b>7524SWC-SCE</b>	CE	909,00	1.144,00	1.303,00
<b>7524SWC-S/S</b>	S	928,00	1.163,00	1.322,00









1645

**Colonna doccia con supporto doccia scorrevole**  
Shower column with sliding holder  
Colonne de douche avec support de douche coulissant  
Säulenbrause mit Schiebe Brausehalter  
Columna para ducha con soporte de ducha deslizable  
Колонна с держателем для выдвигного душа

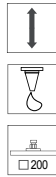

Articolo	Note	CROMO	BO-NO-NKO	BR	O
1945		830,00	•	•	•

1650-S

**Colonna doccia con supporto doccia scorrevole**  
Shower column with sliding holder  
Colonne de douche avec support de douche coulissant  
Säulenbrause mit Schiebe Brausehalter  
Columna para ducha con soporte de ducha deslizable  
Колонна с держателем для выдвигного душа

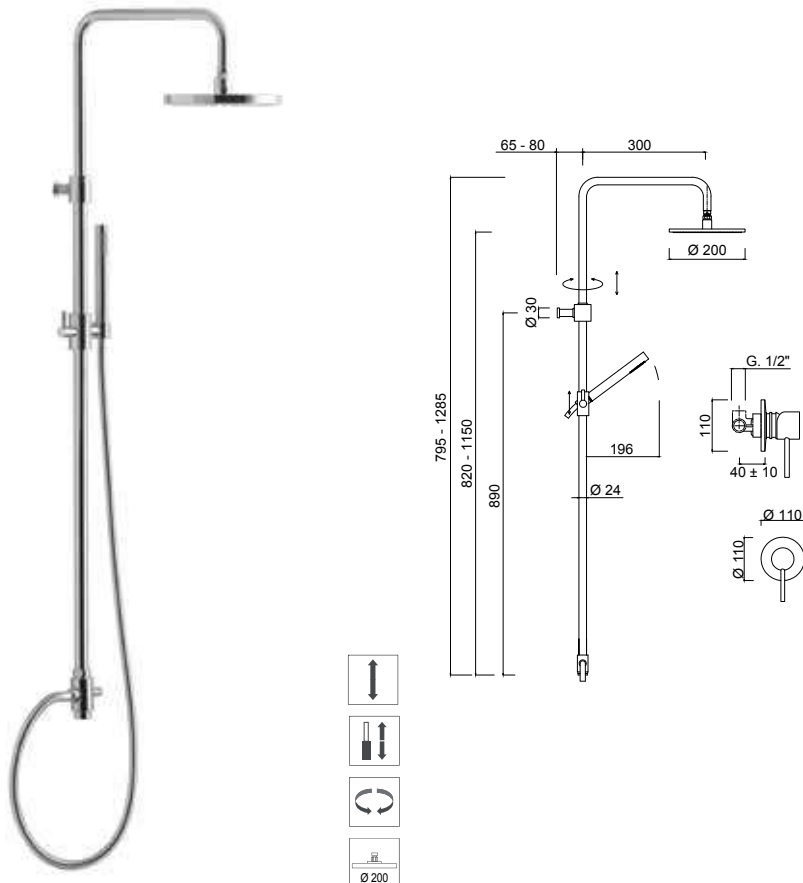

Articolo	Note	CROMO	BO-NO-NKO	BR	O
1650-S		604,00	1.077,00	•	•

1651-S

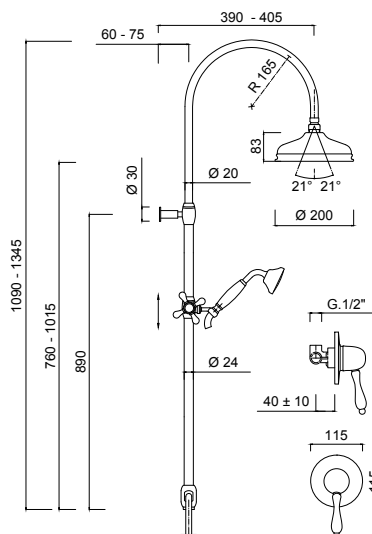

**Colonna doccia con supporto doccia scorrevole**  
Shower column with sliding holder  
Colonne de douche avec support de douche coulissant  
Säulenbrause mit Schiebe Brausehalter  
Columna para ducha con soporte de ducha deslizable  
Колонна с держателем для выдвигаемого душа

Articolo	Note	CROMO	BO-NO-NKO	BR	O
1651-S		710,00	•	880,00	980,00

1655/qua



**Supporto doccia per rubinetto doccia incasso**  
Support for column shower  
Support pour douche à colonne  
Halter für Kolonnendusche  
Suporte para columna de ducha  
Держатель душевой стойки

Articolo	Note	CROMO	BO-NO-NKO	BR	O
1655/qua		55,00	•	•	•

1656/qua



**Supporto doccia con flessibile ottone doppia aggr.**  
Support for column shower  
Support pour douche à colonne  
Halter für Kolonnendusche  
Suporte para columna de ducha  
Держатель душевой стойки

Articolo	Note	CROMO	BO-NO-NKO	BR	O
1656/qua		65,00	•	•	•

1655/cil



**Supporto doccia cilindrico per rubinetto doccia incasso**  
Support for column shower  
Support pour douche à colonne  
Halter für Kolonnendusche  
Suporte para columna de ducha  
Цилиндрический держатель душевой стойки

Articolo	Note	CROMO	BO-NO-NKO	BR	O
1655/cil		50,00	•	•	•

1656/cil



**Supporto doccia cilindrico con flessibile ottone doppia aggr.**

Support for column shower  
Support pour douche à colonne  
Halter für Kolonnendusche  
Suporte para columna de ducha  
Цилиндрический держатель душевой стойки

Articolo	Note	CROMO	BO-NO-NKO	BR	O
1656/cil		60,00	•	•	•

1655/sfe



**Supporto doccia cilindrico per rubinetto doccia incasso**

Support for column shower  
Support pour douche à colonne  
Halter für Kolonnendusche  
Suporte para columna de ducha  
Цилиндрический держатель душевой стойки

Articolo	Note	CROMO	BO-NO-NKO	BR	O
1655/sfe		50,00	•	75,00	90,00

1656/sfe



**Supporto doccia cilindrico con flessibile ottone doppia aggr.**

Support for column shower  
Support pour douche à colonne  
Halter für Kolonnendusche  
Suporte para columna de ducha  
Цилиндрический держатель душевой стойки

Articolo	Note	CROMO	BO-NO-NKO	BR	O
1656/sfe		60,00	•	90,00	108,00

1721-A

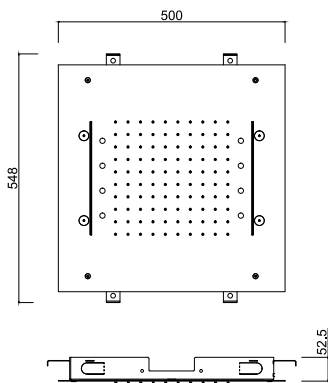

**Soffione inox incasso □ 500, con getto pioggia, 4 nebulizzatori, 2 cascate, sistema di cromoterapia 7 colori con comando remoto touch wireless.**

Stainless steel built-in showerhead □ 500, with rainfall jet, 4 spray jets, 2 waterfall jets and 7-colours LED lights for chromotherapy with touch screen wireless remote-control.

Ciel de pluie à encastrer au plafond en acier inox □ 500 avec jet à pluie, 4 jets latéraux d'eau brumisée, 2 cascades, LED pour la chromothérapie en 7 couleurs avec télécommande à l'écran tactile sans fils.

Kopfbrause Inox □ 500 für Deckenmontage mit Regendusche, 4 Körperbrausen, 2 Wasserfällen, LED Farbtherapie in 7 Farben mit Touch Screen kabelloser Fernbedienung.

Rociador de techo empotrado inox □ 500 con chorro lluvia, 4 jets de agua pulverizada, 2 cascadas, LED luz cromoterapia en 7 colores con control remoto touch screen sin cables.

Встраиваемый верхний душ Ø 500 из нержавеющей стали с функцией дождя, 4 расплывательными форсунками, 2 каскадами, функцией хромотерапии с 7 LED цветами, регулируемая посредством дистанционного сенсорного пульта

Articolo	Note	CROMO	BO-NO-NKO	BR	O
1721-A		2.550,00	•	•	•



1721-B

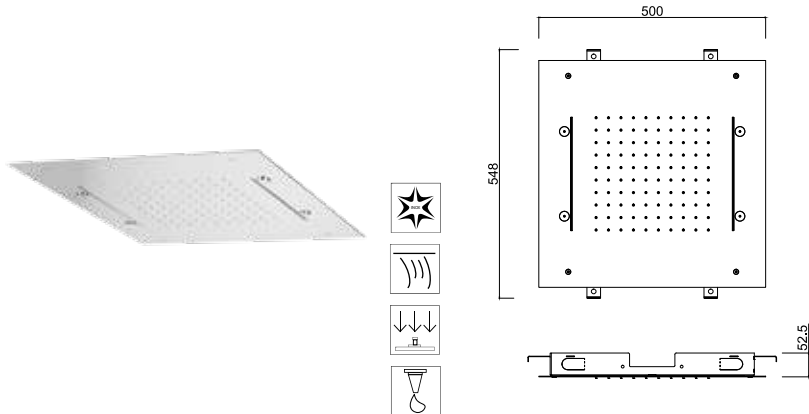

**Soffione inox incasso □ 500, con getto pioggia, 4 nebulizzatori, 2 cascate.**

*Stainless steel built-in showerhead □ 500, with rainfall jet, 4 spray jets, 2 waterfall jets.*

*Ciel de pluie à encastrer au plafond en acier inox □ 500 avec jet à pluie, 4 jets latéraux d'eau brumisée, 2 cascades.*

*Kopfbrause Inox Ø 500 für Deckenmontage mit Regendusche, 4 Körperbrausen, 2 Wasserfällen.*

*Rociador de techo empotrado inox □ 500 con chorro lluvia, 4 jets de agua pulverizada, 2 cascadas.*

*Встраиваемый верхний душ Ø 500 из нержавеющей стали, с функцией дождя, 4 распылительными форсунками, 2 каскадами*

Articolo	Note	CROMO	BO-NO-NKO	BR	O
1721-B		1.795,00	•	•	•

1614

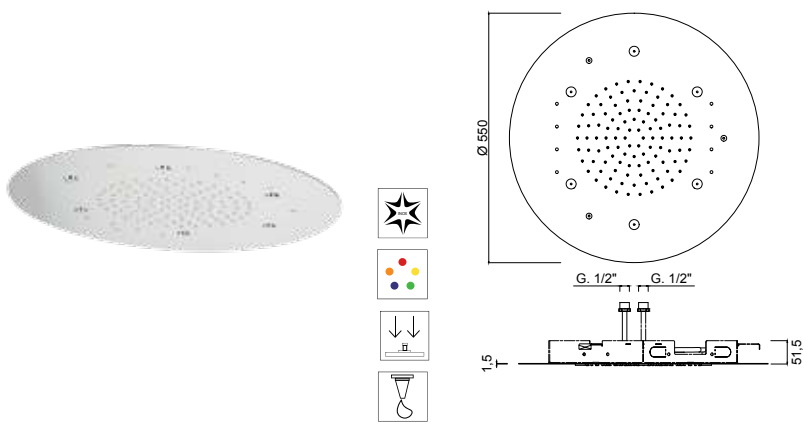

**Soffione inox incasso Ø 550, con getto pioggia, 6 nebulizzatori, sistema di cromoterapia 7 colori con comando remoto touch wireless**

*Ø 550 ceiling-mounted showerhead in inox stainless steel with rain flow, 6 spray jets, 7-colours LED lights for chromotherapy with touch screen wireless remote-control*

*Ciel de pluie en acier inox Ø 550 avec jet à pluie, 6 jets d'eau brumisée, LED pour la chromothérapie en 7 couleurs avec télécommande à l'écran tactile sans fils*

*Edelstahl Kopfbrause Ø 550 mit Regendusche, 6 Wasserstrahlen Spray, LED Farbtherapie in 7 Farben mit Touch Screen kabelloser Fernbedienung*

*Rociador a techo inox Ø 550 con chorro lluvia, 6 chorros de agua pulverizada, LED luz cromoterapia en 7 colores con control remoto touch screen sin cables*

*Верхний душ Ø 550 потолочного монтажа из нержавеющей стали с функцией дождя, 6 распылительных форсунок, функция хромотерапии с 7 LED цветами, регулируемая посредством дистанционного сенсорного пульта*

Articolo	Note	CROMO	BO-NO-NKO	BR	O
1614		2.315,00	•	•	•

1615

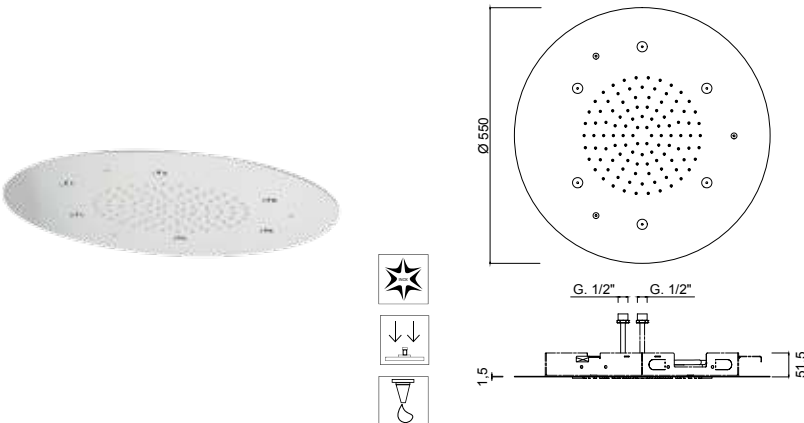

**Soffione inox incasso Ø 550, con getto pioggia, 6 nebulizzatori**

*Inox stainless steel shower head Ø 550, with rain flow, 6 spray jets*

*Ciel de pluie en acier inox Ø 550 avec jet à pluie, 6 jets d'eau brumisée*

*Edelstahl Kopfbrause Ø 550 mit Regendusche, 6 Wasserstrahlen Spray*

*Rociador a techo inox Ø 550 con chorro lluvia, 6 chorros de agua pulverizada*

*Верхний душ Ø 550 из нержавеющей стали с функцией дождя, 6 распылительных форсунок*

Articolo	Note	CROMO	BO-NO-NKO	BR	O
1615		1.155,00	•	•	•

1725-50

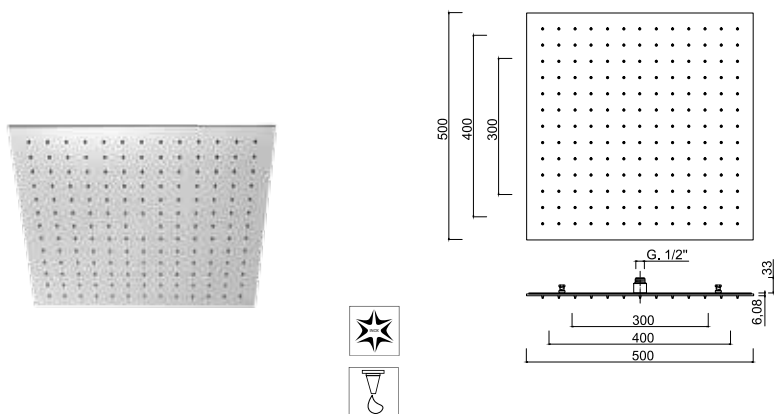

**Soffione inox incasso 500x500, con getto pioggia.**

*Ceiling-mounted stainless steel shower head 500x500, with rainfall jet.*

*Ciel de pluie à encastrer au plafond en acier inox 500x500 avec jet à pluie.*

*Kopfbrause Inox für Deckeneinbau 500x500, mit Regenstrahl.*

*Rociador Inox de techo empotrado 500x500, con chorro lluvia.*

*Верхний душ 500x500 из нержавеющей стали с функцией дождя.*

Articolo	Note	CROMO	BO-NO-NKO	BR	BEO-O
1725-50	mm 500	1.250,00	1.650,00	1.650,00	1.733,00
1725-40	mm 400	1.040,00	1.381,00	1.381,00	1.458,00
1725-30	mm 300	780,00	1.084,00	1.084,00	1.166,00

1726-50

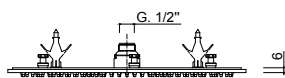
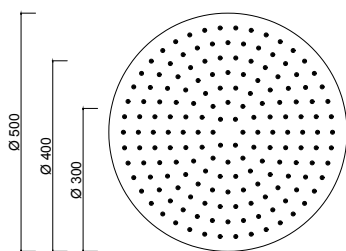

**Soffione inox incasso Ø 500, con getto pioggia.**  
Ceiling-mounted stainless steel shower head Ø 500, with rainfall jet.  
Ciel de pluie à encastrer au plafond en acier inox Ø 500 avec jet à pluie.  
Kopfbrause Inox für Deckeneinbau Ø 500, mit Regenstrahl.  
Rociador Inox de techo empotrado Ø 500, con chorro lluvia.  
Верхний душ Ø 500 из нержавеющей стали с функцией дождя.

Articolo	Note	CROMO	BO-NO-NKO	BR	BEO-O
1726-50	mm 500	1.070,00	1.436,00	1.436,00	1.518,00
1726-40	mm 400	820,00	1.139,00	1.139,00	1.222,00
1726-30	mm 300	670,00	935,00	935,00	1.018,00

1521

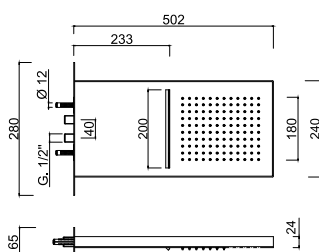
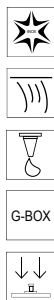

**Soffione a parete, getto pioggia, getto cascata.**  
Wall-mounted showerhead with rainfall and waterfall jets.  
Douche de tête mural avec jet pluie et cascade.  
Kopfbrause für Wandmontage mit Regen- und Wasserfalldusche.  
Rociador ducha a pared, chorro lluvia, cascada.  
Верхний душ настенного монтажа с функциями дождя и водопада

Articolo	Note	CROMO	BO-NO-NKO	BR	O
1521		1.296,00	1.415,00	1.465,00	1.545,00

1733-20

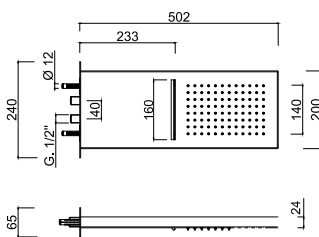

**Soffione a parete, getto pioggia, getto cascata.**  
Wall-mounted showerhead with rainfall and waterfall jets.  
Douche de tête mural avec jet pluie et cascade.  
Kopfbrause für Wandmontage mit Regen- und Wasserfalldusche.  
Rociador ducha a pared, chorro lluvia, cascada.  
Верхний душ настенного монтажа с функциями дождя и водопада

Articolo	Note	CROMO	BO-NO-NKO	BR	O
1733-20	mm 200	769,00	•	•	•

1734-20

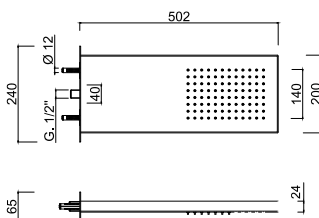

**Soffione a parete, getto pioggia.**  
Wall-mounted showerhead with rainfall jet.  
Douche de tête mural avec jet pluie.  
Kopfbrause für Wandmontage mit Regendusche.  
Rociador ducha a pared, chorro lluvia.  
Верхний душ настенного монтажа с функцией дождя

Articolo	Note	CROMO	BO-NO-NKO	BR	O
1734-20	mm 200	577,00	•	•	•

1735-16

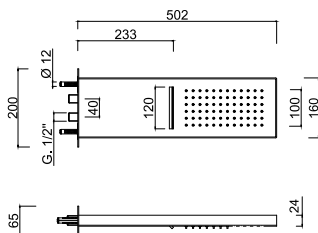

**Soffione a parete, getto pioggia, getto cascata.**  
Wall-mounted showerhead with rainfall and waterfall jets.  
Douche de tête mural avec jet pluie et cascade.  
Kopfbrause für Wandmontage mit Regen- und Wasserfalldusche.  
Rociador ducha a pared, chorro lluvia, cascada.  
Верхний душ настенного монтажа с функциями дождя и водопада

Articolo	Note	CROMO	BO-NO-NKO	BR	O
1735-16	mm 160	715,00	•	•	•

1736-16

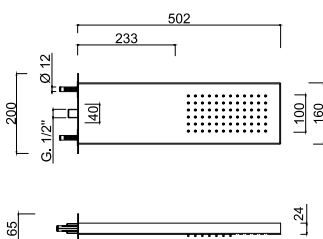

**Soffione a parete, getto pioggia.**  
Wall-mounted showerhead with rainfall jet.  
Douche de tête mural avec jet pluie.  
Kopfbrause für Wandmontage mit Regendusche.  
Rociador ducha a pared, chorro lluvia.  
Верхний душ настенного монтажа с функцией дождя

Articolo	Note	CROMO	BO-NO-NKO	BR	O
1736-16	mm 160	560,00	•	•	•

1613

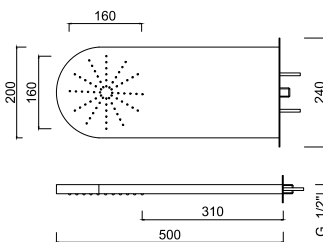

**Soffione a parete.**  
Wall-mounted shower head.  
Pomme de douche murale.  
Kopfbrause zur Wandmontage.  
Rociador de pared.  
Встроенный верхний душ.

Articolo	Note	CROMO	BO-NO-NKO	BR	O
1613		775,00	•	•	•

1739

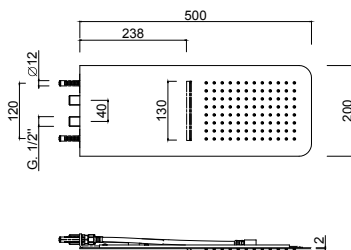

**Soffione a parete, getto pioggia, getto cascata.**  
Wall-mounted showerhead with rainfall and waterfall jets.  
Douche de tête mural avec jet pluie et cascade.  
Kopfbrause für Wandmontage mit Regen- und Wasserfalldusche.  
Rociador ducha a pared, chorro lluvia, cascada.  
Верхний душ настенного монтажа с функциями дождя и водопада

Articolo	Note	CROMO	BO-NO-NKO	BR	O
1739		595,00	•	•	•

1740

**Soffione a parete, getto pioggia.**

Wall-mounted showerhead with rainfall jet.  
Douche de tête mural avec jet pluie.  
Kopfbrause für Wandmontage mit Regendusche.  
Rociador ducha a pared, chorro lluvia.  
Верхний душ настенного монтажа с функцией дождя

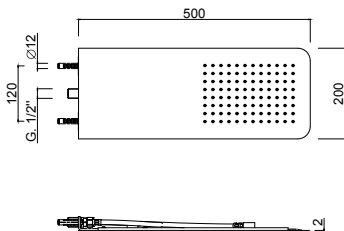

Articolo	Note	CROMO	BO-NO-NKO	BR	O
1740		450,00	•	•	•

1716

**Soffione con braccio doccia a parete.**

Shower head with shower arm.  
Pomme de douche avec bras de douche.  
Kopfbrause mit Wandarm.  
Rociador con brazo de ducha a pared.  
Верхний душ с держателем.

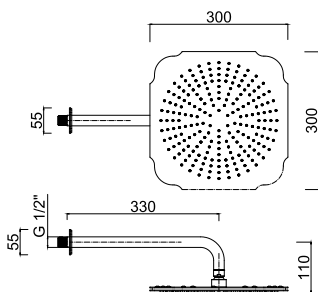

Articolo	Note	CROMO	BO-NO-NKO	AR-BR	O
1716		620,00	•	760,00	840,00

1701-20

**Soffione doccia anticalcare □ 200. Ottone**

Shower head, anti limestone, □ 200 mm. In brass.  
Pomme de douche anticalcaire □ 200 mm. En laiton.  
Kopfbrause, Antikalk System, □ 200 mm. In Messing.  
Rociador antical □ 200 mm, en latón.  
Верхний душ, защита от известняка, □ 200 мм, латунь

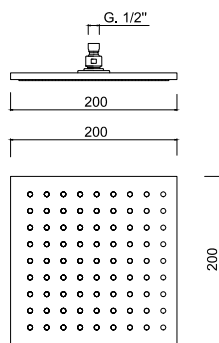

Articolo	Note	CROMO	BO-NO-BKO	BEO	O
1701-20	mm 200	182,00	•	•	•
1701-25	mm 250	297,00	430,00	534,00	•
1701-30	mm 300	358,00	•	•	•

1704-20

**Soffione doccia anticalcare □ 200. Inox**

200 mm diameter shower head, anti limestone. Stainless steel.  
Pomme de douche anticalcaire □ 200 mm. Inox.  
Kopfbrause, Antikalk System □ 200 mm. Inox.  
Rociador antical □ 200 mm. Inoxidable.  
Верхний душ □ 200 мм, защита от известняка, нержавеющая сталь

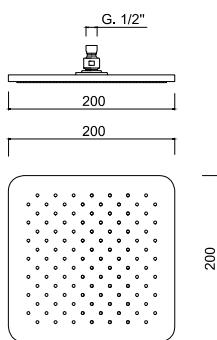

Articolo	Note	CROMO	BO-NO-NKO	BR	O
1704-20	mm 200	121,00	•	•	•
1704-25	mm 250	176,00	•	•	•
1704-30	mm 300	231,00	•	•	•
1704-40	mm 400	363,00	•	•	•

1707-20

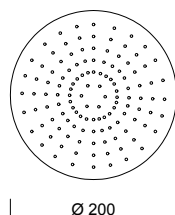
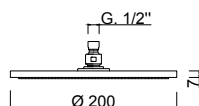

**Soffione doccia anticalcare Ø 200. Ottone**

Shower head, anti limestone, Ø 200 mm. In brass.  
Pomme de douche anticalcaire Ø 200 mm. En laiton.  
Kopfbrause, Antikalk System, Ø 200 mm. In Messing.  
Rociador antical Ø 200 mm, en latón.  
Верхний душ, защита от известняка, Ø 200 мм, латунь

Articolo	Note	CROMO	BO-NO-BKO	BR	O
1707-20	mm 200	176,00	•	•	•
1707-25	mm 250	286,00	425,00	•	•
1707-30	mm 300	341,00	•	•	•

1710-20

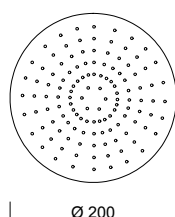
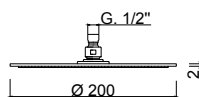

**Soffione doccia anticalcare Ø 200. Inox**

200 mm diameter shower head, anti limestone. Stainless steel.  
Pomme de douche anticalcaire Ø 200 mm. Inox.  
Kopfbrause, Antikalk System Ø 200 mm. Inox.  
Rociador antical Ø 200 mm. Inoxidable.  
Верхний душ Ø 200 мм, защита от известняка, нержавеющая сталь

Articolo	Note	CROMO	BO-NO-NKO	BR	O
1710-20	mm 200	121,00	•	•	•
1710-25	mm 250	171,00	•	•	•
1710-30	mm 300	226,00	•	•	•
1710-40	mm 400	358,00	•	•	•

1718

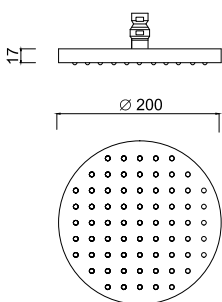

**Soffione doccia anticalcare Ø 200. Abs**

200 mm diameter shower head, anti limestone. Abs  
Pomme de douche anticalcaire Ø 200 mm. Abs  
Kopfbrause, Antikalk System Ø 200 mm. Abs  
Rociador antical Ø 200 mm. Abs  
Верхний душ Ø 200 мм, защита от известняка, Abs

Articolo	Note	CROMO	BO-NO-NKO	BR	O
1718		66,00	•	•	•

1610

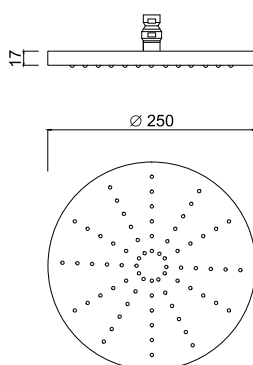

**Soffione doccia anticalcare Ø 250. Ottone**

250 mm diameter shower head, anti limestone, in brass.  
Pomme de douche anticalcaire Ø 250 mm en laiton.  
Kopfbrause, Antikalk System Ø 250 mm, in Messing.  
Rociador antical Ø 250 mm, en latón.  
Верхний душ Ø 250 мм, защита от известняка, латунь

Articolo	Note	CROMO	BO-NO-NKO	BR	O
1610		325,00	•	•	•

1611

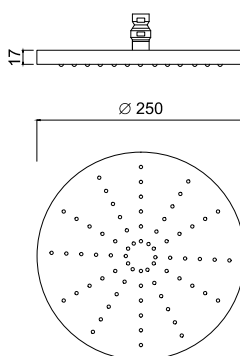

**Soffione doccia anticalcare Ø 250. Abs**

250 mm diameter shower head, anti limestone. Abs  
Pomme de douche anticalcaire Ø 250 mm. Abs  
Kopfbrause, Antikalk System Ø 250 mm. Abs  
Rociador antical Ø 250 mm. Abs  
Верхний душ Ø 250 мм, защита от известняка, Abs

Articolo	Note	CROMO	BO-NO-NKO	BR	O
1611		182,00	•	•	•

1714-20

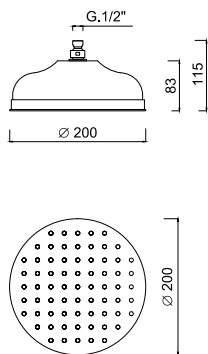

**Soffione doccia Ø 200. Ottone**  
Shower head, Ø 200 mm. In brass.  
Pomme de douche Ø 200 mm. En laiton.  
Kopfbrause Ø 200 mm. In Messing.  
Rociador Ø 200 mm, en latón.  
Верхний душ Ø 200 мм, латунь

Articolo	Note	CROMO	BO-NO-NKO	AR-BR	O
1714-20	mm 200	171,00	•	205,00	229,00
1714-30	mm 300	335,00	•	364,00	420,00

1625

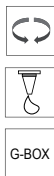
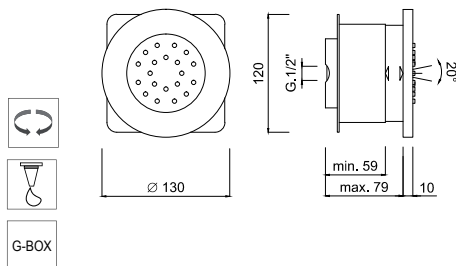

**Soffioncino orientabile laterale incasso**  
Built-in adjustable lateral body spray  
Douchette latérale murale orientable  
Verstellbare UP-Seitenkörperbrause  
Ducha lateral de pared ajustable  
Встроенная регулируемая боковая форсунка

Articolo	Note	CROMO	BO-NO-NKO	BR	O
1625		110,00	•	•	•

1626

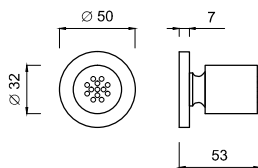

**Soffioncino orientabile laterale esterno**  
External adjustable lateral body spray  
Douchette latérale extérieure orientable  
Externe verstellbare Seitenkörperbrause  
Ducha lateral externa ajustable  
Боковая регулируемая форсунка наружного монтажа

Articolo	Note	CROMO	BO-NO-NKO	BR	O
1626		35,00	•	•	•

1626QD

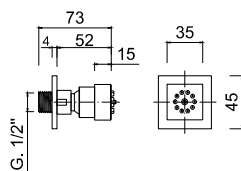

**Soffioncino orientabile laterale esterno.**  
External adjustable lateral body spray.  
Douchette latérale extérieure orientable.  
Externe verstellbare Seitenkörperbrause.  
Ducha lateral externa ajustable.  
Боковая регулируемая форсунка наружного монтажа

Articolo	Note	CROMO	BO-NO-NKO	BR	O
1626QD		61,00	•	•	

1745-33

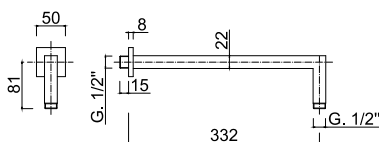

**Braccio doccia in ottone da mm 330.**  
Brass shower arm, length mm 330.  
Bras de douche, laiton chromé, longueur mm 330.  
Wandarm, mm 330 Länge, verchromtes Messing.  
Brazo ducha largo 330 mm, latón cromado.  
Душевой кронштейн из латуни, длина 330 мм.

Articolo	Note	CROMO	BO-NO-NKO	BR	BEO
1745-33	mm 330	116,00	160,00	•	209,00
1745-40	mm 400	120,00	•	•	•

1751-35

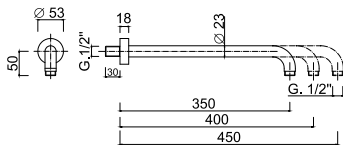

**Braccio doccia in ottone da mm 350.**  
Brass shower arm, length mm 350.  
Bras de douche, laiton chromé, longueur mm 350.  
Wandarm, mm 350 Länge, verchromtes Messing.  
Brazo ducha largo 350 mm, latón cromado.  
Душевой кронштейн из латуни, длина 350 мм.

Articolo	Note	CROMO	BO-NO-BKO	AR-BR	O
1751-35	mm 350	78,00	121,00	121,00	150,00
1751-40	mm 400	83,00	•	•	•
1751-45	mm 450	98,00	•	•	•

1757

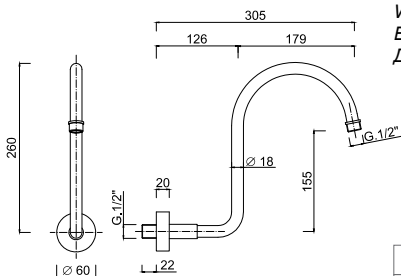

**Braccio doccia in ottone**  
Brass shower arm.  
Bras de douche en laiton.  
Wandarm aus Messing.  
Brazo de ducha a pared en latón.  
Держатель для душевой лейки из латуни

Articolo	Note	CROMO	BO-NO-NKO	AR-BR	O
1757		98,00	•	135,00	163,00

1760-20

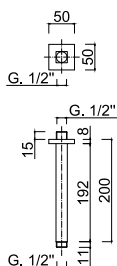

**Braccio doccia da soffitto mm.200.**  
Ceiling shower arm mm 200.  
Bras de douche vertical mm 200.  
Brausearm für Deckenmontage mm 200.  
Brazo de ducha a techo mm 200.  
Держатель душа 200 мм, потолочный

Articolo	Note	CROMO	BO-NO-NKO	BR	BEO
1760-20	mm 200	71,00	113,00	•	128,00
1760-30	mm 300	75,00	•	•	•

1762-10

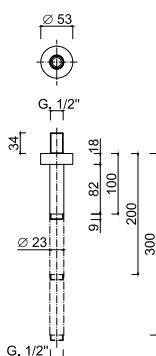

**Braccio doccia da soffitto mm.100.**  
Ceiling shower arm mm 100.  
Bras de douche vertical mm 100.  
Brausearm für Deckenmontage mm 100.  
Brazo de ducha a techo mm 100.  
Держатель душа 100 мм, потолочный

Articolo	Note	CROMO	BO-NO-BKO	AR-BR	BEO-O
1762-10	mm 200	52,00	78,00	78,00	102,00
1762-20	mm 250	61,00	•	•	•
1762-30	mm 300	70,00	•	•	•

1515

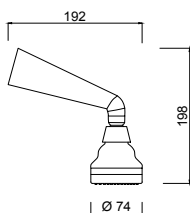

**Braccio doccia con soffione anticalcare**  
Shower arm with anti-limescale shower head.  
Bras de douche avec pomme de douche anti-calcaire.  
Wandarm mit Antikalk-Kopfbrause.  
Brazo de ducha a pared con rociador ducha anticalcárea.  
Душевая лейка с антиизвестковым распылителем и держателем

Articolo	Note	CROMO	BO-NO-NKO	BR	O
1515		72,00	•	•	•

1665

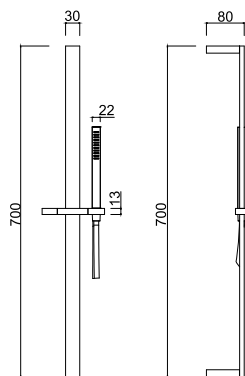

**Saliscendi (tutto ottone) con doccia ottone**

Brass sliding rail with brass hand-shower.

Barre de douche en laiton avec douchette en laiton.

Messing-Brausestange mit Handbrause aus Messing.

Barra deslizante de latón con ducha de mano de latón.

регулируемая душевая штанга из латуни с латунным душем

Articolo	Note	CROMO	BO-NO-NKO	BEO	O
1665		264,00	535,00	550,00	

1667

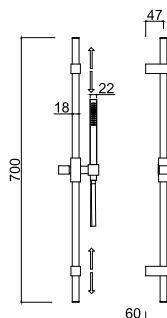

**Saliscendi (tutto ottone) con doccia abs**

Brass sliding rail with ABS hand-shower.

Barre de douche en laiton avec douchette en ABS.

Messing-Brausestange mit ABS-Handbrause.

Barra deslizante de latón con ducha de mano de ABS.

регулируемая душевая штанга из латуни с душем из ABS

Articolo	Note	CROMO	BO-NO-NKO	BR	O
1667		244,00	•	•	•

1669

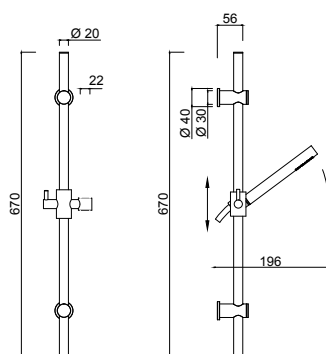

**Saliscendi (tutto ottone) con doccia abs**

Brass sliding rail with ABS hand-shower.

Barre de douche en laiton avec douchette en ABS.

Messing-Brausestange mit ABS-Handbrause.

Barra deslizante de latón con ducha de mano de ABS.

регулируемая душевая штанга из латуни с душем из ABS

Articolo	Note	CROMO	BO-NO-NKO	BR	O
1669		149,00	378,00	•	•

1671

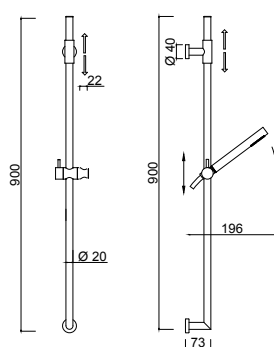

**Saliscendi con doccia Futuro. Allungabile**

Adjustable sliding rail with Futuro hand-shower.

Barre de douche extensible avec douchette Futuro.

Verstellbare Brausestange mit Futuro-Handbrause.

Barra deslizante extensible con ducha de mano Futuro.

регулируемая штанга с ручным душем Futuro. Раздвижная

Articolo	Note	CROMO	BO-NO-NKO	BR	O
1671		222,00	•	•	•

1673

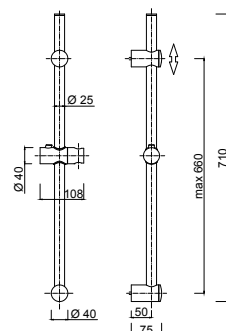

**Asta saliscendi regolabile**

Adjustable sliding rail.

Barre de douche extensible.

Verstellbare Brausestange.

Barra deslizante extensible.

регулируемая душевая штанга

Articolo	Note	CROMO	BO-NO-NKO	BR	O
1673		55,00	•	•	•



**PR1598**

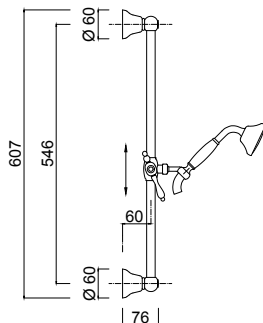

**Saliscendi maniglia Praga con doccia Praga.**  
Sliding bar with flexible hose and Praga handshower.  
Barre de douche avec flexible et douchette Praga.  
Brausegarnitur mit Wandstange Praga.  
Barre deslizante cob flexible y ducha Praga.  
Душевая стойка Praga с ручкой Praga.

Articolo	Note	CROMO	CR	AR-BR	O
<b>PR1598</b>		246,00	270,00	345,00	443,00
<b>PR1598L</b>	L	252,00	276,00	351,00	449,00
<b>PR1598CE</b>	CE	277,00	301,00	376,00	474,00
<b>PR1598/S</b>	S	296,00	320,00	395,00	493,00

**PA1597**

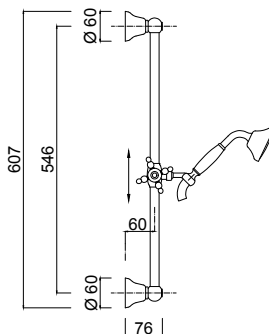

**Saliscendi maniglia Parigi con doccia Londra.**  
Sliding rail with Parigi handle and Londra handshower.  
Barre de douche avec poignée Parigi et douchette Londra.  
Brausestange mit Parigi-Griff und Londra-Handbrause.  
Barra deslizante con maneta Parigi y ducha de mano Londra.  
регулируемая душевая штанга, ручка модель Parigi и ручной душ модель Londra

Articolo	Note	CROMO	CR	BR	O
<b>PA1597</b>	PA	242,00	270,00	340,00	438,00
<b>LN1597</b>	LN	242,00	270,00	340,00	438,00
<b>KN1597</b>	KN	244,00	272,00	343,00	440,00
<b>LO1597</b>	LO	242,00	270,00	340,00	438,00

**1505-PR**

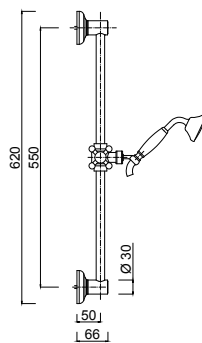

**Saliscendi con doccia Praga**  
Sliding rail with Praga handshower.  
Barre de douche avec douchette Praga.  
Brausestange mit Praga-Handbrause.  
Barra deslizante con ducha de mano Praga.  
регулируемая душевая штанга, ручной душ модель Praga

Articolo	Note	CROMO	BO-NO-NKO	BR	O
<b>1505-PR</b>		181,00	•	280,00	410,00

**1505-LN**

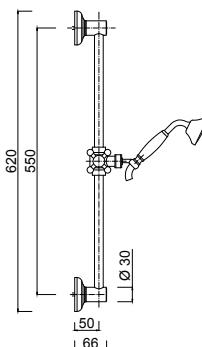

**Saliscendi con doccia Londra**  
Sliding rail with Londra handshower.  
Barre de douche avec douchette Londra.  
Brausestange mit Londra-Handbrause.  
Barra deslizante con ducha de mano Londra.  
регулируемая душевая штанга, ручной душ модель Londra

Articolo	Note	CROMO	BO-NO-NKO	BR	O
<b>1505-LN</b>		181,00	•	280,00	410,00

**1505-LO**

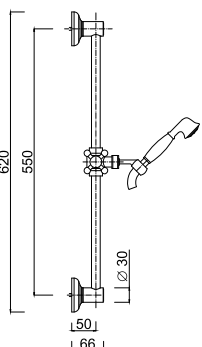

**Saliscendi con doccia Lotus**  
Sliding rail with Lotus handshower.  
Barre de douche avec douchette Lotus.  
Brausestange mit Lotus-Handbrause.  
Barra deslizante con ducha de mano Lotus.  
регулируемая душевая штанга, ручной душ модель Lotus

Articolo	Note	CROMO	BO-NO-NKO	AR-BR	O
<b>1505-LO</b>		175,00	•	270,00	390,00

1594

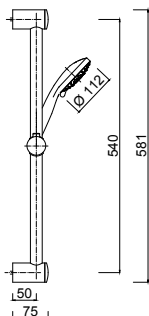

**Saliscendi con doccia abs**  
Sliding rail with ABS hand-shower.  
Barre de douche avec douchette en ABS.  
Brausestange mit ABS-Handbrause.  
Barra deslizante con ducha de mano de ABS.  
регулируемая душевая штанга с душем из ABS

Articolo	Note	CROMO	BO-NO-NKO	BR	O
1594		91,00	•	•	•

1599/EX

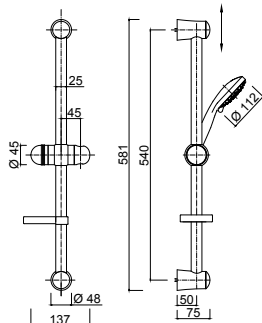

**Saliscendi con doccia abs 3 getti, portasapone.**  
Sliding rail with ABS 3-jet hand-shower and soap-holder.  
Barre de douche avec douchette 3 jets en ABS et porte-savon.  
Brausestange mit ABS-Handbrause 3 Strahlarten und Seifenhalter.  
Barra deslizante con ducha de mano de ABS 3 chorros y jabonera.  
регулируемая душевая штанга с душем из ABS 3 струи и держатель для мыла

Articolo	Note	CROMO	BO-NO-NKO	BR	O
1599/EX		75,00	•	•	•

1595

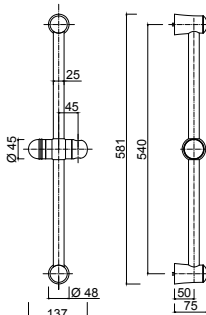

**Asta saliscendi**  
Sliding rail.  
Barre de douche.  
Brausestange.  
Barra deslizante.  
регулируемая душевая штанга

Articolo	Note	CROMO	BO-NO-NKO	BR	O
1595		40,00	•	•	•

1510QD

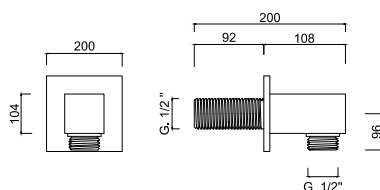

**Presca acqua 1/2"**  
Water plug 1/2"  
Prise d'eau mural 1/2"  
Wandanschlußbogen 1/2" für Brauseanschluß  
Toma de agua 1/2"  
Крепление к стене для гибкого шланга

Articolo	Note	CROMO	BO-NO-NKO	BEO	O
1510QD		40,00	66,00	72,00	•

1510CL

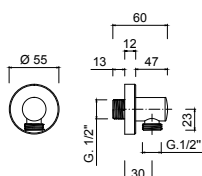

**Presca acqua 1/2"**  
Water plug 1/2"  
Prise d'eau mural 1/2"  
Wandanschlußbogen 1/2" für Brauseanschluß  
Toma de agua 1/2"  
Крепление к стене для гибкого шланга

Articolo	Note	CROMO	BO-NO-NKO	BEO	O
1510CL		25,00	48,00	50,00	•

1510

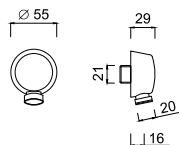

**Presca acqua 1/2"**  
Water plug 1/2"  
Prise d'eau mural 1/2"  
Wandanschlußbogen 1/2" für Brauseanschluß  
Toma de agua 1/2"  
Крепление к стене для гибкого шланга

Articolo	Note	CROMO	BO-NO-NKO	AR-BR	O
1510		16,00	•	24,00	33,00

1540

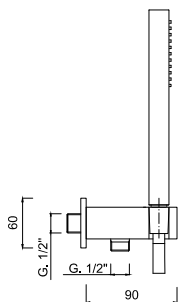

**Kit duplex incasso Pablolux.**  
Built-in duplex shower kit Pablolux.  
Ensemble de douche duplex à encaissement Pablolux.  
Einbaubrauseset Duplex Pablolux.  
Conjunto de ducha duplex para empotrar Pablolux.  
встроенный душевой набор "Duplex" Pablolux.

Articolo	Note	CROMO	BO-NO-NKO	BEO	O
1540		104,00	225,00	250,00	•

1545

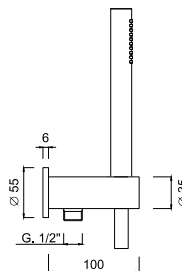

**Kit duplex incasso Futuro.**  
Built-in duplex shower kit Futuro.  
Ensemble de douche duplex à encaissement Futuro.  
Einbaubrauseset Duplex Futuro.  
Conjunto de ducha duplex para empotrar Futuro.  
встроенный душевой набор "Duplex" Futuro.

Articolo	Note	CROMO	BO-NO-NKO	BR	O
1545		84,00	219,00	•	•

1551

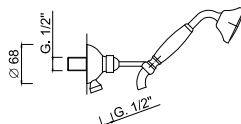

**Kit duplex incasso Praga.**  
Built-in duplex shower kit Praga.  
Ensemble de douche duplex à encaissement Praga.  
Einbaubrauseset Duplex Praga.  
Conjunto de ducha duplex para empotrar Praga.  
встроенный душевой набор "Duplex" Praga.

Articolo	Note	CROMO	CR	AR-BR	O
1551		124,00	136,00	174,00	242,00
1551CE	CE	145,00	157,00	195,00	263,00

1550

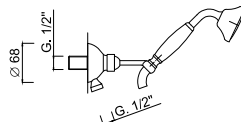

**Kit duplex incasso Londra.**  
Built-in duplex shower kit Londra.  
Ensemble de douche duplex à encaissement Londra.  
Einbaubrauseset Duplex Londra.  
Conjunto de ducha duplex para empotrar Londra.  
встроенный душевой набор "Duplex" Londra.

Articolo	Note	CROMO	CR	BR	O
1550		124,00	136,00	180,00	258,00

1552

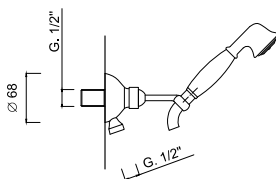

**Kit duplex incasso Lotus.**

Built-in duplex shower kit Lotus.  
Ensemble de douche duplex à encaissement Lotus.  
Einbaubrauseset Duplex Lotus.  
Conjunto de ducha duplex para empotrar Lotus.  
встроенный душевой набор "Duplex" Lotus.

Articolo	Note	CROMO	BO-NO-BKO	BR	O
1552		107,00	•	163,00	241,00
1552-N	NY	107,00	•	163,00	241,00
1552CE		128,00	•	184,00	262,00

1554

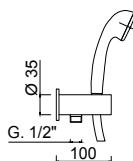

**Kit duplex incasso Contemporary.**

Built-in duplex shower kit Contemporary.  
Ensemble de douche duplex à encaissement Contemporary.  
Einbaubrauseset Duplex Contemporary.  
Conjunto de ducha duplex para empotrar Contemporary.  
встроенный душевой набор "Duplex" Contemporary.

Articolo	Note	CROMO	BO-NO-NKO	BR	O
1554		91,00	•	•	•

1720

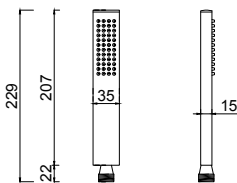

**Doccetta monogetto ottone**

Brass single-jet hand-shower.  
Douchette 1 jet en laiton.  
Handbrause Messing 1 Strahlart.  
Ducha de mano de latón 1 chorro.  
одноструйный душ и латуни

Articolo	Note	CROMO	BO-NO-NKO	BR	O
1720		55,00	•	•	•

1781

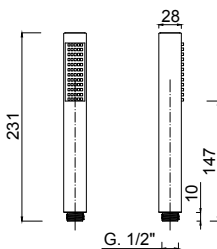

**Doccetta monogetto ottone**

Brass single-jet hand-shower.  
Douchette 1 jet en laiton.  
Handbrause Messing 1 Strahlart.  
Ducha de mano de latón 1 chorro.  
одноструйный душ и латуни

Articolo	Note	CROMO	BO-NO-NKO	BR	O
1781		40,00	90,00	•	•
3215QD	ABS	26,00	•	•	•

1782

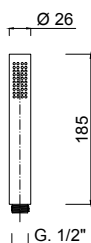

**Doccetta monogetto ottone**

Brass single-jet hand-shower.  
Douchette 1 jet en laiton.  
Handbrause Messing 1 Strahlart.  
Ducha de mano de latón 1 chorro.  
одноструйный душ и латуни

Articolo	Note	CROMO	BO-NO-NKO	BR	O
1782		38,00	98,00	•	•
3215Q	ABS	15,00	•	•	•

1780

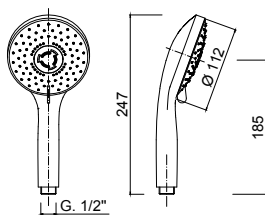

**Doccetta 3 getti abs**

ABS 3-jet hand-shower.  
Douchette 3 jets en ABS.  
ABS-Handbrause 3 Strahlarten.  
Ducha de mano de ABS 3 chorros.  
душ из ABS 3 вида струи

Articolo	Note	CROMO	BO-NO-NKO	BR	O
1780		30,00	•	•	•

1779

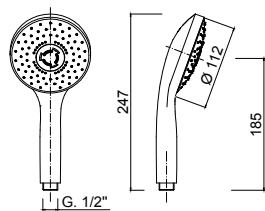

**Doccetta monogetto abs**

ABS single-jet hand-shower.  
Douchette 1 jet en ABS.  
ABS-Handbrause 1 Strahlart.  
Ducha de mano de ABS 1 chorro.  
одноструйный душ из ABS

Articolo	Note	CROMO	BO-NO-NKO	BR	O
1779		23,00	•	•	•

1586

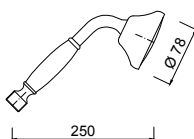

**Doccetta Praga.**

Praga hand-shower.  
Douchette Praga.  
Praga Handbrause.  
Ducha de teléfono Praga.  
Душевая лейка Praga.

Articolo	Note	CROMO	CR	AR-BR	O
1586		61,00	67,00	73,00	95,00
1586CE	CE	82,00	88,00	94,00	116,00

1585

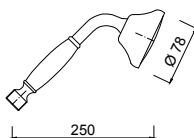

**Doccetta manopola ottone Londra**

Londra hand-shower brass handle.  
Douchette avec poignée en laiton Londra  
Londra Handbrause mit Griff aus Messing  
Ducha de teléfono empuñadura latón Londra  
Душевая лейка с ручкой из латуни Londra

Articolo	Note	CROMO	CR	BR	O
1585		61,00	67,00	73,00	95,00

1529

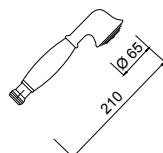

**Doccetta manopola ottone Lotus**

Lotus hand-shower brass handle.  
Douchette avec poignée en laiton Lotus  
Lotus Handbrause mit Griff aus Messing  
Ducha de teléfono empuñadura latón Lotus  
Душевая лейка с ручкой из латуни Lotus

Articolo	Note	CROMO	CR	AR-BR	O
1529		45,00	46,00	59,00	76,00
1529CE	CE	66,00	•	80,00	97,00

1530

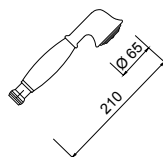

**Doccetta manopola naylor Lotus**

Lotus hand-shower nylon handle.  
Douchette avec poignée en nylon Lotus  
Lotus Handbrause mit Griff aus Nylon  
Ducha de teléfono empuñadura nailon Lotus  
Душевая лейка с ручкой из нейлона Lotus

Articolo	Note	CROMO	BO-NO-NKO	BR	O
1530		45,00	•	59,00	76,00

1536

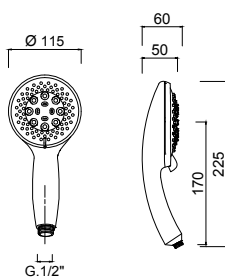

**Doccetta 5 getti abs**

ABS 5-jet hand-shower.  
Douchette 5 jets en ABS.  
ABS-Handbrause 5 Strahlarten.  
Ducha de mano de ABS 5 chorros.  
душ из ABS 5 вида струи

Articolo	Note	CROMO	BO-NO-NKO	BR	O
1536		71,00	•	•	•

1524

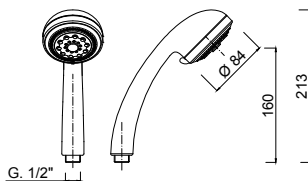

**Doccetta 3 getti abs**

ABS 3-jet hand-shower.  
Douchette 3 jets en ABS.  
ABS-Handbrause 3 Strahlarten.  
Ducha de mano de ABS 3 chorros.  
душ из ABS 3 вида струи

Articolo	Note	CROMO	BO-NO-NKO	BR	O
1524		30,00	•	•	•

1526K

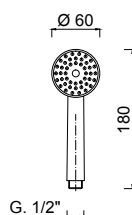

**Doccetta monogetto abs**

ABS single-jet hand-shower.  
Douchette 1 jet en ABS.  
ABS-Handbrause 1 Strahlart.  
Ducha de mano de ABS 1 chorro.  
однотруйный душ из ABS

Articolo	Note	CROMO	BO-NO-NKO	BR	O
1526K		20,00	•	•	•

1527

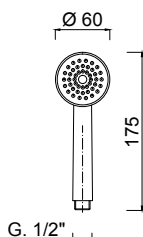

**Doccetta monogetto abs**

ABS single-jet hand-shower.  
Douchette 1 jet en ABS.  
ABS-Handbrause 1 Strahlart.  
Ducha de mano de ABS 1 chorro.  
однотруйный душ из ABS

Articolo	Note	CROMO	BO-NO-NKO	BR	O
1527		8,00	•	•	•

1765

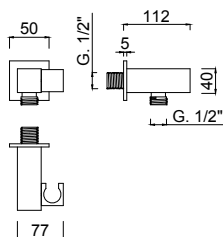

**Supporto duplex incasso con presa acqua**  
Built-in adjustable shower holder with water plug.  
Support orientable à encastrer avec prise d'eau.  
Verstellbarer UP-Handbrausehalter mit Wandanschlussbogen.  
Soporte de ducha orientable empotrado con toma de agua.  
Встроенный держатель для душа с забором воды

Articolo	Note	CROMO	BO-NO-NKO	BR	O
1765		82,00	•	•	•

1769

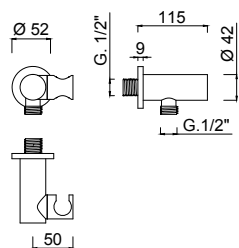

**Supporto duplex incasso con presa acqua**  
Built-in adjustable shower holder with water plug.  
Support orientable à encastrer avec prise d'eau.  
Verstellbarer UP-Handbrausehalter mit Wandanschlussbogen.  
Soporte de ducha orientable empotrado con toma de agua.  
Встроенный держатель для душа с забором воды

Articolo	Note	CROMO	BO-NO-NKO	BR	O
1769		63,00	•	•	•

1774

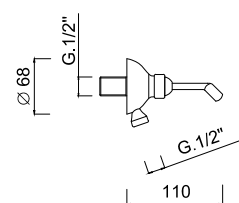

**Supporto duplex incasso con presa acqua**  
Built-in adjustable shower holder with water plug.  
Support orientable à encastrer avec prise d'eau.  
Verstellbarer UP-Handbrausehalter mit Wandanschlussbogen.  
Soporte de ducha orientable empotrado con toma de agua.  
Встроенный держатель для душа с забором воды

Articolo	Note	CROMO	BO-NO-NKO	BR	O
1774		51,00	•	66,00	72,00

1559/Q

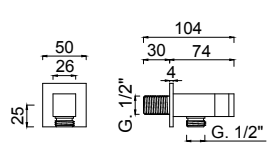

**Supporto doccia con presa acqua**  
Shower holder with water plug.  
Support avec prise d'eau.  
Handbrausehalter mit Wandanschlussbogen.  
Soporte para ducha con toma de agua.  
настенный держатель для душа с забором воды

Articolo	Note	CROMO	BO-NO-NKO	BR	O
1559/Q		60,00	95,00	•	•

1559/M

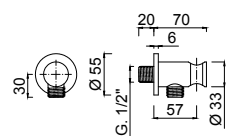

**Supporto doccia con presa acqua**  
Shower holder with water plug.  
Support avec prise d'eau.  
Handbrausehalter mit Wandanschlussbogen.  
Soporte para ducha con toma de agua.  
настенный держатель для душа с забором воды

Articolo	Note	CROMO	BO-NO-NKO	BR	O
1559/M		56,00	89,00	92,00	99,00

1767

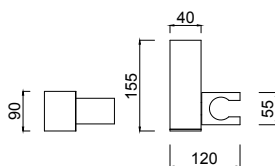

**Supporto duplex esterno abs**

Adjustable ABS shower holder.  
Support douche orientable ABS.  
Verstellbarer AP-Handbrausehalter ABS.  
Soporte de ducha orientable de superficie de ABS.  
Регулируемый держатель для душа ABS

Articolo	Note	CROMO	BO-NO-NKO	BR	O
1767		15,00	•	•	•

1772

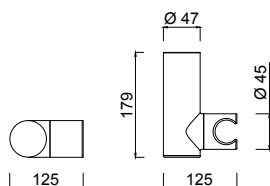

**Supporto duplex esterno abs**

Adjustable ABS shower holder.  
Support douche orientable ABS.  
Verstellbarer AP-Handbrausehalter ABS.  
Soporte de ducha orientable de superficie de ABS.  
Регулируемый держатель для душа ABS

Articolo	Note	CROMO	BO-NO-NKO	BR	O
1772		15,00	•	•	•

1560

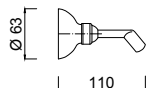

**Supporto duplex esterno ottone**

Adjustable brass shower holder.  
Support douche orientable laiton.  
Verstellbarer AP-Handbrausehalter Messing.  
Soporte de ducha orientable de superficie de latón.  
Регулируемый держатель для душа из латуни

Articolo	Note	CROMO	CR	BR	O
1560		31,00	34,00	53,00	58,00

1777

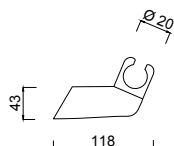

**Supporto duplex esterno abs**

Adjustable ABS shower holder.  
Support douche orientable ABS.  
Verstellbarer AP-Handbrausehalter ABS.  
Soporte de ducha orientable de superficie de ABS.  
Регулируемый держатель для душа ABS

Articolo	Note	CROMO	BO-NO-NKO	BR	O
1777		9,00	•	•	•

1768



**Supporto esterno fisso ottone**

Brass shower holder.  
Support douche fixe en laiton.  
AP-Handbrausehalter Messing.  
Soporte de ducha fijo de superficie de latón.  
фиксированный держатель для душа из латуни

Articolo	Note	CROMO	BO-NO-NKO	BR	O
1768		42,00	•	•	•



1773

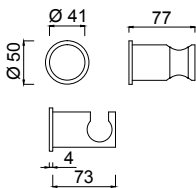

**Supporto esterno fisso ottone**

Brass shower holder.  
Support douche fixe en laiton.  
AP-Handbrausehalter Messing.  
Soporte de ducha fijo de superficie de latón.  
фиксированный держатель для душа из латуни

Articolo	Note	CROMO	BO-NO-NKO	BR	O
1773		42,00	•	•	•

1558

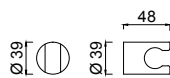

**Supporto esterno fisso abs**

Shower holder abs  
Support mural fixe abs  
Wandbrausehalter abs  
Soporte exterior fijo abs  
Фиксированный держатель для душа abs

Articolo	Note	CROMO	BO-NO-NKO	BR	O
1558		5,00	•	•	•

1730

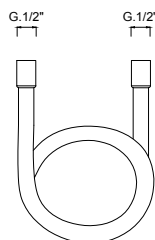

**Flessibile girevole cm.150 in PVC.**

PVC flexible, cm.150.  
Flexible en PVC, cm.150.  
PVC Brauseschlauch, cm.150.  
Tubo flexible en PVC, cm.150.  
Гибкий шланг, 150 см.

Articolo	Note	CROMO	BO-NO-NKO	BR	O
1730		28,00	28,00	•	•
1730-12	cm 120	28,00	28,00	•	•

1570

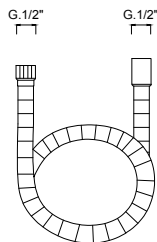

**Flessibile cm 100 CC.**

Flexible brass hose cm. 100 CC.  
Flexible laiton cm. 100 CC.  
Messing-Brauseschlauch cm.100 CC.  
Tubo flexible cm 100 CC.  
Гибкий шланг 100 см с зажимом.

Articolo	Note	CROMO	BO-NO-BKO	BR	O
1570		12,00	•	•	•
1571	cm 150	14,00	•	•	•
1572	cm 200	22,00	•	•	•

1569

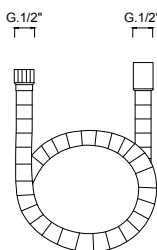

**Flessibile ottone doppia aggraffatura cm.100 CC.**

Flexible brass hose cm. 100 doubleinterlock.  
Flexible laiton double agrafage cm 100.  
Messing-Brauseschlauch cm100.  
Flexible latón doble grapado cm 100.  
Гибкий шланг 100 см с двойным зажимом

Articolo	Note	CROMO	BO-NO-BKO	AR-BR	O
1569		17,00	•	30,00	65,00
1573	cm 150	16,00	•	35,00	75,00
1574	cm 200	28,00	•	42,00	77,00

1578



**Flessibile senza piombo per monoforo doccetta estraibile monocomandi.**

*Flexible without lead for single-lever extractable hand-shower.  
Flexible sans plomb pour monotrou douchette extractible  
Schlauch ohne Bleigewicht für Einlochmischer mit ausziehbarer Handbrause  
Tubo flexible sin plomo para monomando ducha de teléfono extraíble.  
Гибкий шланг без заглушки для однорычажного смесителя для душевой лейки*

Articolo	Note	CROMO	BO-NO-NKO	BR	O
1578		23,00	•	•	•

1579



**Piombo per flessibile.**

*Lead for flexible.  
Plomb pour flexible  
Bleigewicht für Schlauch  
Plomo para tubo flexible.  
Заглушка для гибкого шланга*

Articolo	Note	CROMO	BO-NO-NKO	BR	O
1579		8,00	•	•	•

1582



**Flessibile per batteria bordo vasca cm 200 doppia aggraffatura. Specificare per quale articolo**

*Flexible for bath edge set - cm 200 double seaming. Specify for which item.  
Flexible en laiton pour baigne/douche cm.200 double agrafage. Spécifier pour quel article.  
Messing-Brauseschlauch für Wannenrand cm.200. Für welche Artikelnummer nennen.  
Tubo flexible para batería borde bañera cm 200 doble lámina. Especificuen la referencia.  
Гибкий шланг 200 см с двойным зажимом. Уточнить, для какого артикула*

Articolo	Note	CROMO	BO-NO-NKO	BR	O
1582		33,00	•	45,00	90,00



TERMOSTATICI

8203

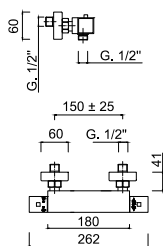

**Termostatico doccia esterno attacco da 1/2"**  
External thermostatic shower mixer with 1/2" connection.  
Mélangeur thermostatique pour douche 1/2".  
Thermostat-Brausebatterie 1/2".  
Mezclador termostático externo ducha 1/2".  
Термостатический смеситель внешнего монтажа с соединением 1/2"

Articolo	Note	CROMO	CR	BR	O
8203		260,00	•	•	•

8204

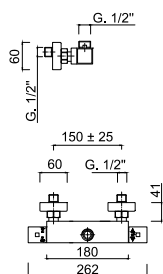

**Termostatico doccia esterno attacco superiore da 3/4"**  
Wall-mounted thermostatic shower mixer with 3/4" upper connection.  
Mitigeur thermostatique douche avec raccord supérieur 3/4".  
AP-Thermostat mit Anschluss oben 3/4".  
Termostática ducha de superficie con ataco superior 3/4".  
Термостатический смеситель для душа настенного монтажа с верхним подключением на 3/4"

Articolo	Note	CROMO	CR	BR	O
8204		260,00	•	•	•

8205

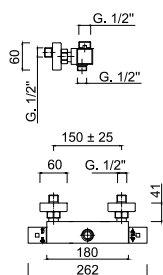

**Termostatico doccia esterno con deviatore incorporato, attacco superiore da 3/4", inferiore da 1/2"**  
Wall-mounted thermostatic shower mixer with integrated diverter, 3/4" upper connection, 1/2" lower connection.  
Mitigeur thermostatique douche avec inverseur intégré, raccord supérieur 3/4" et raccord inférieur 1/2".  
AP-Thermostat mit integriertem Umsteller, Anschlüsse oben 3/4" und unten 1/2".  
Termostática ducha de superficie con inversor integrado, ataco superior 3/4" y inferior 1/2".  
Термостатический смеситель для душа настенного монтажа с интегрированным дивертером, верхним подключением на 3/4", нижним подключением на 1/2"

Articolo	Note	CROMO	CR	BR	O
8205		280,00	•	•	•

8208CL

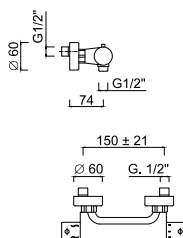

**Miscelatore termostatico doccia esterno.**  
External shower thermostatic mixer.  
Mélangeur thermostatique pour douche.  
Thermostat-Brausebatterie.  
Mezclador termostático externo ducha.  
Термостатический смеситель для внешнего душа

Articolo	Note	CROMO	CR	BR	O
8208CL		298,00	•	•	•

8221

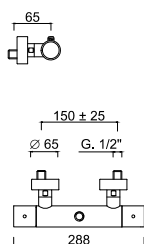

**Miscelatore termostatico doccia esterno Uscita superiore**  
External shower thermostatic mixer with upper connection  
Mélangeur thermostatique pour douche avec connexion supérieure  
Thermostat-Brausebatterie mit oberen Anschluss  
Mezclador termostático externo ducha con conexión superior  
Термостатический смеситель для внешнего душа с верхним соединением

Articolo	Note	CROMO	CR	BR	O
8221		370,00	•	•	•

**8209-PA**

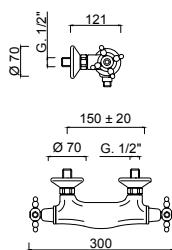

**Miscelatore termostatico doccia esterno.**

External shower thermostatic mixer.  
Mélangeur thermostatique pour douche.  
Thermostat-Brausebatterie.  
Mezclador termostático externo ducha.  
Термостатический смеситель для внешнего душа

Articolo	Note	CROMO	CR	BR	O
<b>8209-PA</b>	PA	433,00	455,00	588,00	720,00
<b>8209-PR</b>	PR	443,00	465,00	598,00	730,00
<b>8209-PRL</b>	PRL	455,00	477,00	610,00	742,00
<b>8209-PRCE</b>	PRCE	463,00	485,00	618,00	750,00
<b>8209-PR/S</b>	PR/S	543,00	565,00	698,00	830,00

**8223**

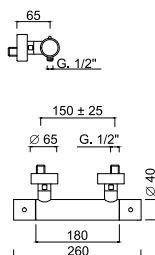

**Miscelatore termostatico doccia esterno.**

External shower thermostatic mixer.  
Mélangeur thermostatique pour douche.  
Thermostat-Brausebatterie.  
Mezclador termostático externo ducha.  
Термостатический смеситель для внешнего душа

Articolo	Note	CROMO	CR	BR	O
<b>8223</b>		215,00	•	•	

**8224**

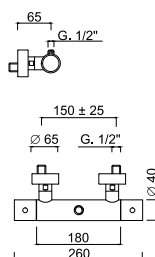

**Termostatico doccia esterno attacco superiore da 3/4"**

Wall-mounted thermostatic shower mixer with 3/4" upper connection.  
Mitigeur thermostatique douche avec raccord supérieur 3/4".  
AP-Thermostat mit Anschluss oben 3/4".  
Termostática ducha de superficie con ataco superior 3/4".  
Термостатический смеситель для душа настенного монтажа с верхним подключением на 3/4"

Articolo	Note	CROMO	CR	BR	O
<b>8224</b>		220,00	•	•	

**8225**

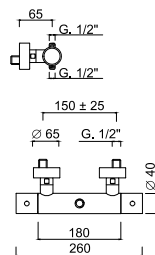

**Termostatico doccia esterno con deviatore incorporato, attacco superiore da 3/4", inferiore da 1/2"**

Wall-mounted thermostatic shower mixer with integrated diverter, 3/4" upper connection, 1/2" lower connection.  
Mitigeur thermostatique douche avec inverseur intégré, raccord supérieur 3/4" et raccord inférieur 1/2".  
AP-Thermostat mit integriertem Umsteller, Anschlüsse oben 3/4" und unten 1/2".  
Termostática ducha de superficie con inversor integrado, ataco superior 3/4" y inferior 1/2".  
Термостатический смеситель для душа настенного монтажа с интегрированным дивертером, верхним подключением на 3/4", нижним подключением на 1/2"

Articolo	Note	CROMO	CR	BR	O
<b>8225</b>		230,00	•	•	

**8208**

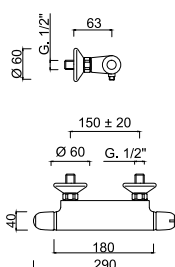

**Miscelatore termostatico doccia esterno.**

External shower thermostatic mixer.  
Mélangeur thermostatique pour douche.  
Thermostat-Brausebatterie.  
Mezclador termostático externo ducha.  
Термостатический смеситель для внешнего душа

Articolo	Note	CROMO	CR	BR	O
<b>8208</b>		226,00	•	•	

**8212-PB**



T<sub>38°</sub>

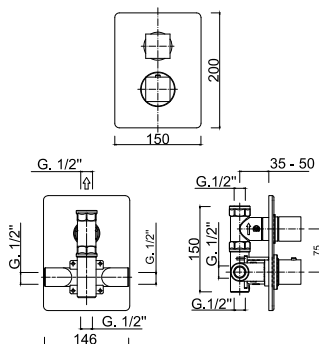

**Termostatico incasso 1/2", con rubinetto d'arresto 1/2".**  
Built-in thermostatic mixer 1/2", with built-in tap 1/2".  
Mitigeur thermostatique mural, 1/2", avec robinet mural 1/2".  
Eingebaute Einhebel Thermostatatterie 1/2", mit Ventil 1/2".  
Mezclador termostatico a empotrar 1/2", con grifo 1/2".  
Встраиваемый термостат 1/2" со встраиваемым смесителем 3/4".

Articolo	Note	CROMO	BO-NO-NKO	BR	O
8212-PB		440,00	594,00	•	•

**8213-PB**



T<sub>38°</sub>

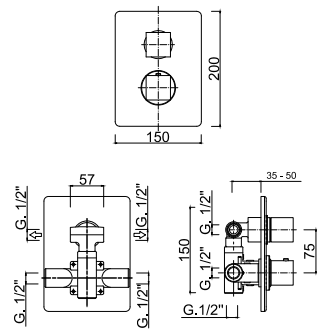

**Termostatico incasso 2 uscite**  
2 outlets built-in thermostatic mixer  
Mitigeur thermostatique murale à 2 sorties  
2-Ausgänge eingebaute Einhebel-Thermostatatterie  
Mezclador termostatico a empotrar a 2 salidas.  
Встроенный термостатический смеситель на 2 выхода

Articolo	Note	CROMO	BO-NO-NKO	BR	O
8213-PB		490,00	662,00	•	•

**8270**



G-BOX  
T<sub>38°</sub>

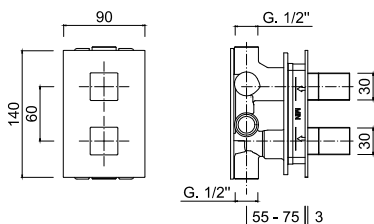

**Termostatico incasso 2 uscite, box incasso.**  
Built-in thermostatic mixer with 2 outlets, built-in box.  
Mitigeur thermostatique douche à encastrer avec 2 sorties, box d'encastrement.  
UP-Thermostat mit 2-Wege-Umstellung, inkl. Box.  
Termostática empotrada 2 salidas, box empotrado incluido.  
Встраиваемый термостатический смеситель с 2 выходами, встраиваемый бокс

Articolo	Note	CROMO	BO-NO-NKO	BR	O
8270		825,00	1.114,00	•	•

**8271**



G-BOX  
T<sub>38°</sub>

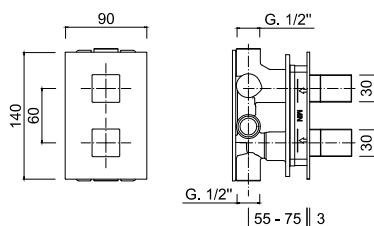

**Termostatico incasso 3 uscite, box incasso.**  
Built-in thermostatic mixer with 3 outlets, built-in box.  
Mitigeur thermostatique douche à encastrer avec 3 sorties, box d'encastrement.  
UP-Thermostat mit 3-Wege-Umstellung, inkl. Box.  
Termostática empotrada 3 salidas, box empotrado incluido.  
Встраиваемый термостатический смеситель с 3 выходами, встраиваемый бокс

Articolo	Note	CROMO	BO-NO-NKO	BR	O
8271		895,00	1.209,00	•	•

**8272**



G-BOX  
T<sub>38°</sub>

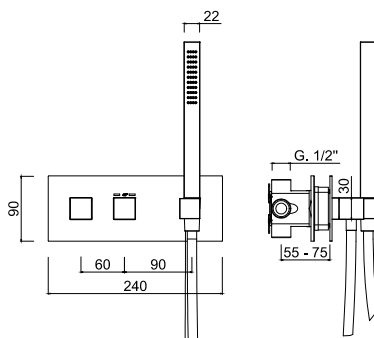

**termostatico incasso, set doccia, 1 uscita libera, box incasso.**  
Built-in thermostatic mixer, integrated shower set + 1 additional water outlet, built-in box.  
Mitigeur thermostatique douche à encastrer, ensemble de douche + 1 sortie supplémentaire disponible, box d'encastrement.  
UP-Thermostat, integrierte Brauseset + 1 zusätzlicher Verbraucher, inkl. Box.  
Termostática empotrada, kit de ducha, 1 salida adicional disponible, box empotrado incluido.  
Встраиваемый термостатический смеситель, интегрированный душевой комплект + дополнительный выход воды, встраиваемый бокс

Articolo	Note	CROMO	BO-NO-NKO	BR	O
8272		1.050,00	1.418,00	•	•

8273

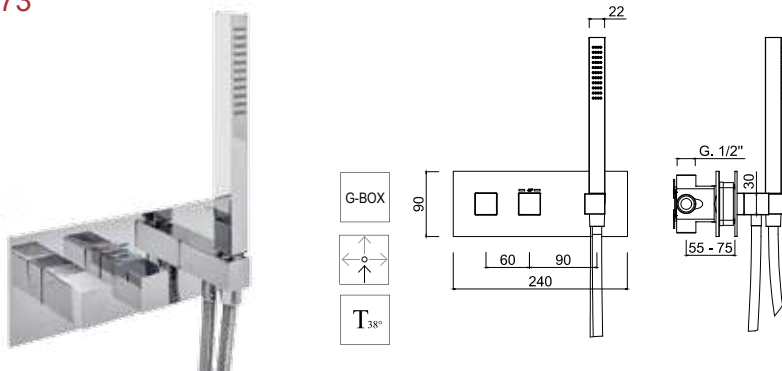

**termostatico incasso, set doccia, 2 uscite libere, box incasso.**  
Built-in thermostatic mixer, integrated shower set + 2 additional water outlets, built-in box.  
Mitigeur thermostatique douche à encastrer, ensemble de douche + 2 sorties supplémentaires disponibles, box d'encastrement.  
UP-Thermostat, integrierte Brauseset + 2 zusätzliche Verbraucher, inkl. Box.  
Termostática empotrada, kit de ducha, 2 salidas adicionales disponibles, box empotrado incluido.  
Встраиваемый термостатический смеситель, интегрированный душевой комплект + 2 дополнительных выхода воды, встраиваемый бокс

Articolo	Note	CROMO	BO-NO-NKO	BR	O
8273		1.110,00	1.499,00	•	•

8212-FU

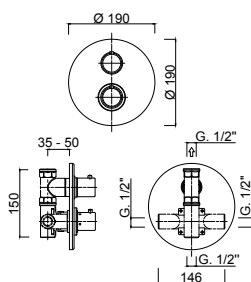

**Termostatico incasso 1/2", con rubinetto d'arresto 1/2".**  
Built-in thermostatic mixer 1/2", with built-in tap 1/2".  
Mitigeur thermostatique mural, 1/2", avec robinet mural 1/2".  
Eingebaute Einhebel Thermostatbatterie 1/2", mit Ventil 1/2".  
Mezclador termostatico a empotrar 1/2", con grifo 1/2".  
Встраиваемый термостат 1/2" со встраиваемым смесителем 3/4".

Articolo	Note	CROMO	BO-NO-NKO	BR	O
8212-FU		440,00	594,00	•	•

8213-FU

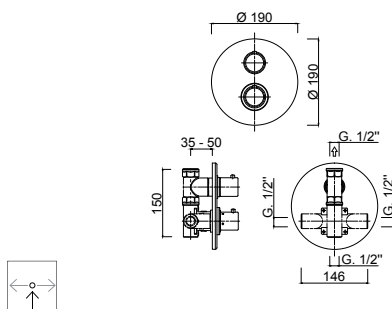

**Termostatico incasso 2 uscite**  
2 outlets built-in thermostatic mixer  
Mitigeur thermostatique mural à 2 sorties  
2-Ausgänge eingebaute Einhebel-Thermostatbatterie  
Mezclador termostatico a empotrar a 2 salidas.  
Встроенный термостатический смеситель на 2 выхода

Articolo	Note	CROMO	BO-NO-NKO	BR	O
8213-FU		490,00	662,00	•	•

8276

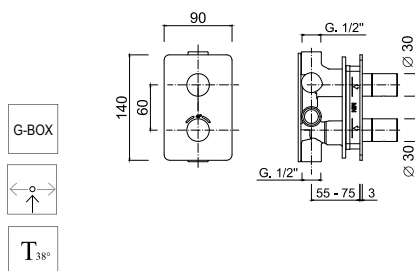

**Termostatico incasso 2 uscite, box incasso.**  
Built-in thermostatic mixer with 2 outlets, built-in box.  
Mitigeur thermostatique douche à encastrer avec 2 sorties, box d'encastrement.  
UP-Thermostat mit 2-Wege-Umstellung, inkl. Box.  
Termostática empotrada 2 salidas, box empotrado incluido.  
Встраиваемый термостатический смеситель с 2 выходами, встраиваемый бокс

Articolo	Note	CROMO	BO-NO-NKO	BR	O
8276		760,00	1.026,00	•	•

8277

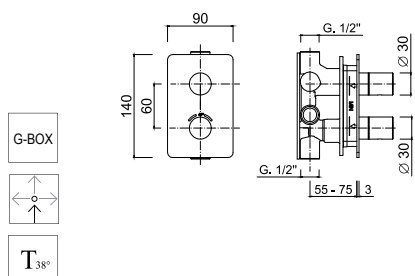

**Termostatico incasso 3 uscite, box incasso.**  
Built-in thermostatic mixer with 3 outlets, built-in box.  
Mitigeur thermostatique douche à encastrer avec 3 sorties, box d'encastrement.  
UP-Thermostat mit 3-Wege-Umstellung, inkl. Box.  
Termostática empotrada 3 salidas, box empotrado incluido.  
Встраиваемый термостатический смеситель с 3 выходами, встраиваемый бокс

Articolo	Note	CROMO	BO-NO-NKO	BR	O
8277		820,00	1.107,00	•	•

8278

**termostatico incasso, set doccia, 1 uscita libera, box incasso.**  
Built-in thermostatic mixer, integrated shower set + 1 additional water outlet, built-in box.

Mitigeur thermostatique douche à encastrer, ensemble de douche + 1 sortie supplémentaire disponible, box d'encastrement.

UP-Thermostat, integrierte Brauseset + 1 zusätzlicher Verbraucher, inkl. Box.

Termostática empotrada, kit de ducha, 1 salida adicional disponible, box empotrado incluido.

Встраиваемый термостатический смеситель, интегрированный душевой комплект + дополнительный выход воды, встраиваемый бокс

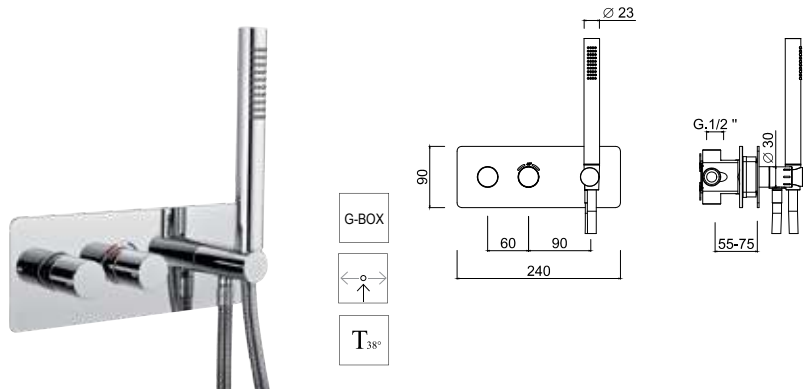

Articolo	Note	CROMO	BO-NO-NKO	BR	O
8278		970,00	1.310,00	•	•

8279

**termostatico incasso, set doccia, 2 uscite libere, box incasso.**  
Built-in thermostatic mixer, integrated shower set + 2 additional water outlets, built-in box.

Mitigeur thermostatique douche à encastrer, ensemble de douche + 2 sorties supplémentaires disponibles, box d'encastrement.

UP-Thermostat, integrierte Brauseset + 2 zusätzliche Verbraucher, inkl. Box.

Termostática empotrada, kit de ducha, 2 salidas adicionales disponibles, box empotrado incluido.

Встраиваемый термостатический смеситель, интегрированный душевой комплект + 2 дополнительных выхода воды, встраиваемый бокс

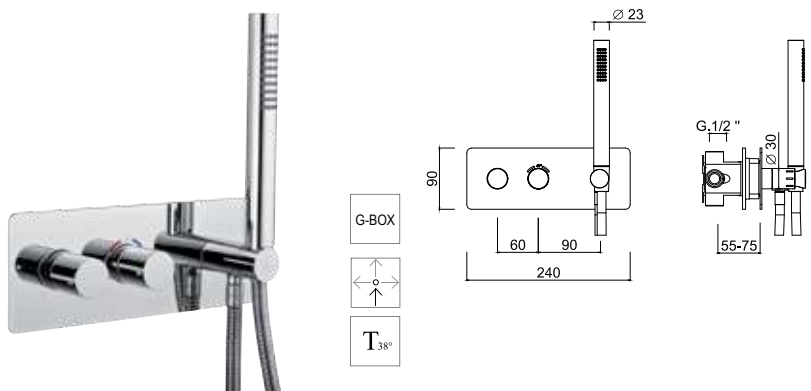

Articolo	Note	CROMO	BO-NO-NKO	BR	O
8279		1.025,00	1.384,00	•	•

8212-PR

**Termostatico incasso 1/2", con rubinetto d'arresto 1/2".**

Built-in thermostatic mixer 1/2", with built-in tap 1/2".

Mitigeur thermostatique mural 1/2", avec robinet mural 1/2".

Eingebaute Einhebel Thermostatbatterie 1/2", mit Ventil 1/2".

Mezclador termostatico a empotrar 1/2", con grifo 1/2".

Встраиваемый термостат 1/2" со встраиваемым смесителем 3/4".

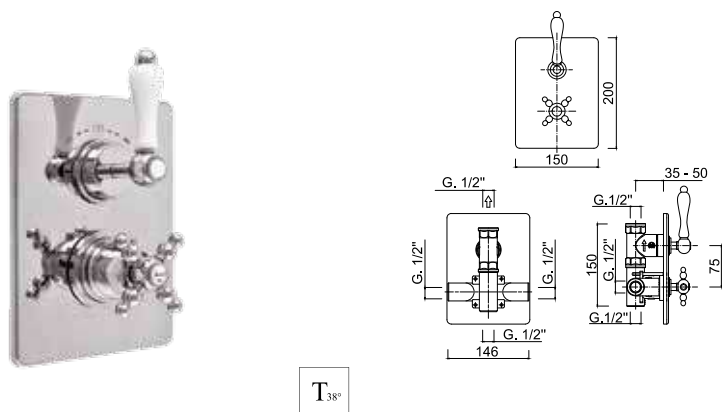

Articolo	Note	CROMO	CR	BR	O
8212-PR	PR	480,00	528,00	672,00	768,00
8212-PRL	PRL	492,00	540,00	684,00	780,00
8212-PRCE	PRCE	500,00	548,00	692,00	788,00
8212-PR/S	PR/S	580,00	628,00	772,00	868,00

8213-PR

**Termostatico incasso 2 uscite**

2 outlets built-in thermostatic mixer

Mitigeur thermostatique mural à 2 sorties

2-Ausgänge eingebaute Einhebel-Thermostatbatterie

Mezclador termostatico a empotrar a 2 salidas.

Встроенный термостатический смеситель на 2 выхода

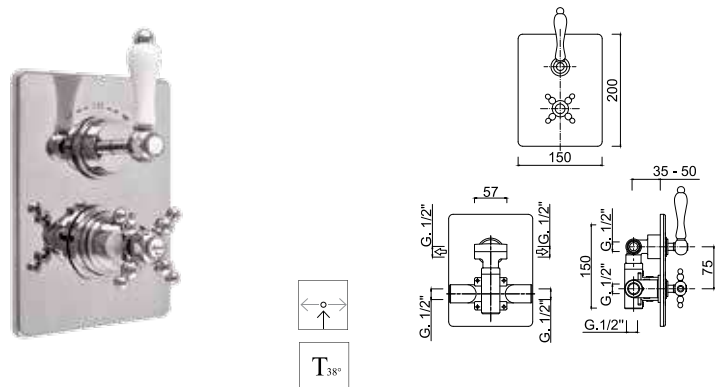

Articolo	Note	CROMO	CR	BR	O
8213-PR	PR	530,00	583,00	742,00	848,00
8213-PRL	PRL	542,00	595,00	754,00	860,00
8213-PRCE	PRCE	550,00	603,00	762,00	868,00
8213-PR/S	PR/S	630,00	683,00	842,00	948,00



## 8282-PR

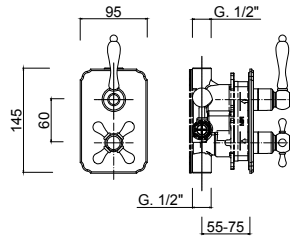
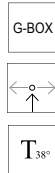

### Termostatico incasso 2 uscite, box incasso.

Built-in thermostatic mixer with 2 outlets, built-in box.

Mitigeur thermostatique douche à encastrer avec 2 sorties, box d'encastrement.

UP-Thermostat mit 2-Wege-Umstellung, inkl. Box.

Termostática empotrada 2 salidas, box empotrado incluido.

Встраиваемый термостатический смеситель с 2 выходами, встраиваемый бокс

Articolo	Note	CROMO	CR	BR	O
8282-PR	PR	840,00	882,00	1.092,00	1.260,00
8282-PRL	PRL	846,00	888,00	1.098,00	1.266,00
8282-PRCE	PRCE	850,00	892,00	1.102,00	1.270,00
8282-PR/S	PR/S	890,00	932,00	1.142,00	1.310,00

## 8283-PR

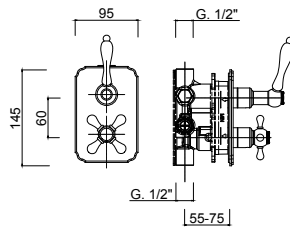
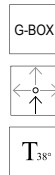

### Termostatico incasso 3 uscite, box incasso.

Built-in thermostatic mixer with 3 outlets, built-in box.

Mitigeur thermostatique douche à encastrer avec 3 sorties, box d'encastrement.

UP-Thermostat mit 3-Wege-Umstellung, inkl. Box.

Termostática empotrada 3 salidas, box empotrado incluido.

Встраиваемый термостатический смеситель с 3 выходами, встраиваемый бокс

Articolo	Note	CROMO	CR	BR	O
8283-PR	PR	890,00	934,00	1.157,00	1.335,00
8283-PRL	PRL	896,00	940,00	1.163,00	1.341,00
8283-PRCE	PRCE	900,00	944,00	1.167,00	1.345,00
8283-PR/S	PR/S	940,00	984,00	1.207,00	1.385,00

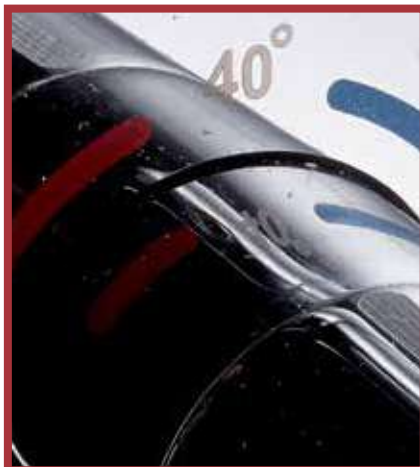

**SOVRATAMPOGRAFIA**  
Tampografia su marcatura laser per una maggior tenuta nel tempo

**LASER MARKS**  
Laser Print marking for long lasting

**LASER GRIP**  
Incisioni laser tecnico/decorative aumentano la presa alla manopola

**LASER GRIP**  
High-performance Grip Laser printing for easy handling even with wet hands

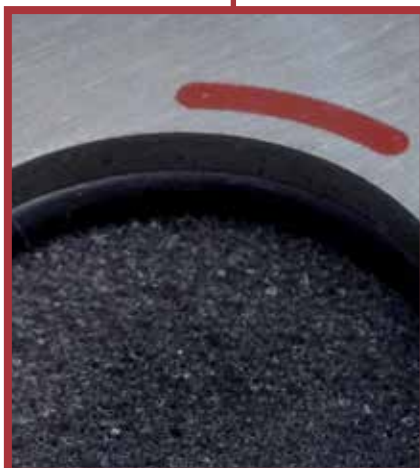
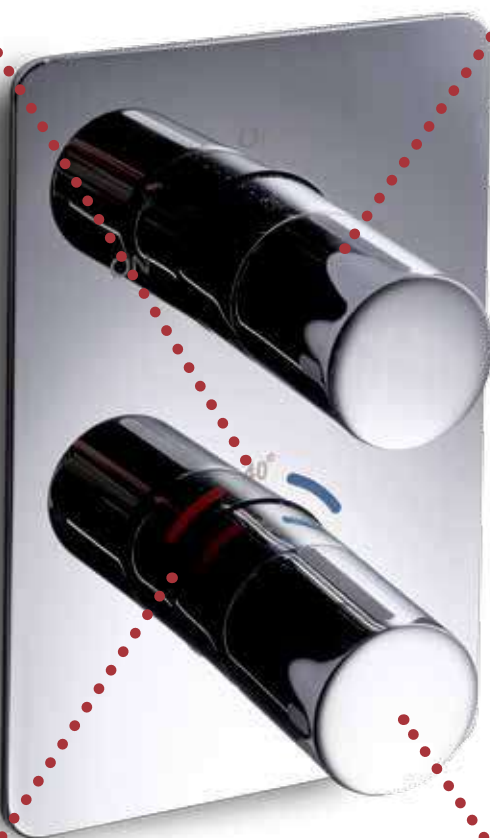

**GHOST FIX**  
Piastra inox 18/10 cromata con sistema di fissaggio senza viti a vista

**GHOST FIX**  
Inox plate without any visible fixing point, for a cleaner design

**SAFE STOP**  
Blocco di sicurezza con innovativo sistema "pull and turn"

**SAFE STOP**  
Innovative safestop pulling system

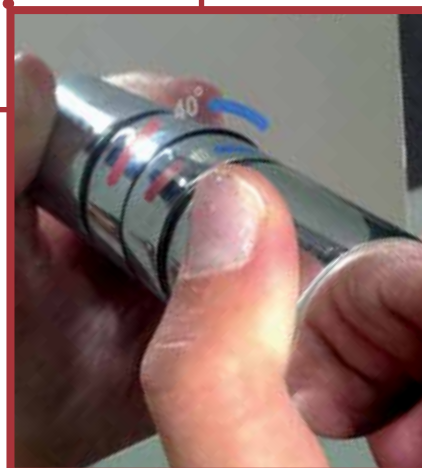



**MULTI FIX - SLIM BODY**  
Ancoraggi multipli per adattarsi ai svariati supporti di una casa moderna. Non solo mattone...

**MULTI FIX - SLIM BODY**  
Multiple fixing point for easy installation with every kind of wall

**WATERPROOF**  
Studiato per rispondere alle più severe norme sulla tenuta stagna negli incassi

**WATERPROOF**  
Waterproof system to ensure top performance

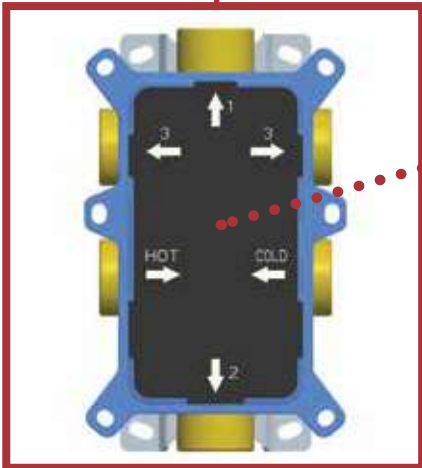
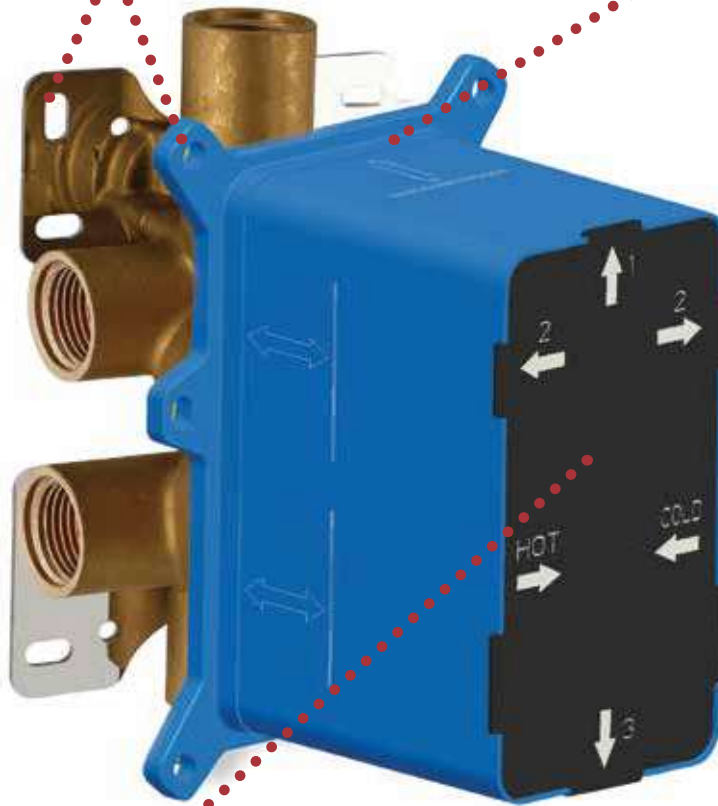
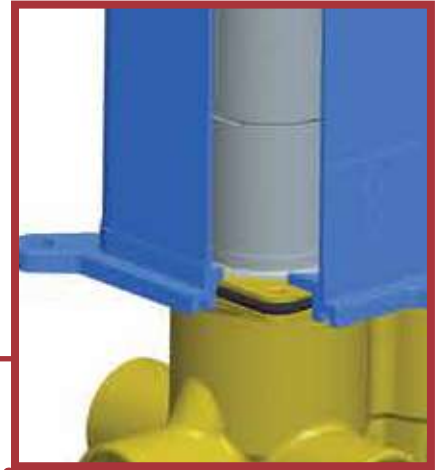

**EASYLOGIC**  
Disposizione razionale delle uscite

**EASYLOGIC**  
Clear installation system with logical disposition of outlets

**RUBINETTI D'ARRESTO**  
Direttamente nella parte frontale corpo per un'immediata ispezione delle cartucce, termostatica e deviatrice

**STOP VALVES**  
Frontal stop valves for quick maintenance operations







SHUTT OFF

**SH20**

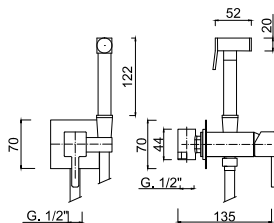

**Miscelatore monocomando incasso per bidet**

*Built-in single-lever mixer for bidet  
Mitigeur à encastrer pour bidet  
UP-Einhebelmischer für Bidet  
Monomando empotrado para bidé  
Однорычажный встраиваемый смеситель для биде.*

Articolo	Note	CROMO	BO-NO-NKO	BR	O
SH20		183,00	•	•	•

**SH20/P**

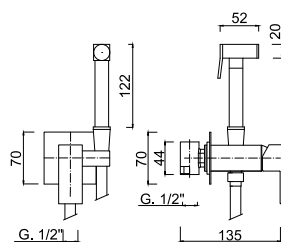

**Miscelatore monocomando incasso per bidet**

*Built-in single-lever mixer for bidet  
Mitigeur à encastrer pour bidet  
UP-Einhebelmischer für Bidet  
Monomando empotrado para bidé  
Однорычажный встраиваемый смеситель для биде.*

Articolo	Note	CROMO	BO-NO-NKO	BR	O
SH20/P		198,00	•	•	•

**SH22**

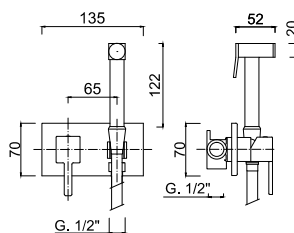

**Miscelatore monocomando per bidet, con piastra**

*Single-lever mixer for bidet with plate.  
Mitigeur pour bidet avec plaque.  
Einhebelmischer für Bidet mit Platte.  
Monomando para bidé con placa.  
однокомандный смеситель гигиенического душа с панелью*

Articolo	Note	CROMO	BO-NO-NKO	BR	O
SH22		195,00	•	•	•

**SH22/P**

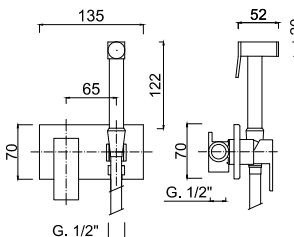

**Miscelatore monocomando per bidet, con piastra**

*Single-lever mixer for bidet with plate.  
Mitigeur pour bidet avec plaque.  
Einhebelmischer für Bidet mit Platte.  
Monomando para bidé con placa.  
однокомандный смеситель гигиенического душа с панелью*

Articolo	Note	CROMO	BO-NO-NKO	BR	O
SH22/P		210,00	•	•	•

**SH25**

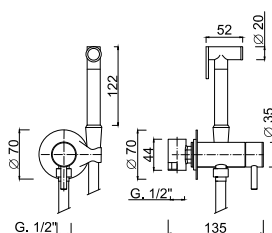

**Miscelatore monocomando incasso per bidet**

*Built-in single-lever mixer for bidet  
Mitigeur à encastrer pour bidet  
UP-Einhebelmischer für Bidet  
Monomando empotrado para bidé  
Однорычажный встраиваемый смеситель для биде.*

Articolo	Note	CROMO	BO-NO-NKO	BR	O
SH25		150,00	305,00	•	•

**SH25/S**

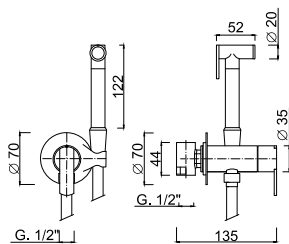

**Miscelatore monocomando incasso per bidet**

*Built-in single-lever mixer for bidet  
Mitigeur à encastrer pour bidet  
UP-Einhebelmischer für Bidet  
Monomando empotrado para bidé  
Однорычажный встраиваемый смеситель для биде*

Articolo	Note	CROMO	BO-NO-NKO	BR	O
SH25/S		175,00	349,00	•	•

**SH27**

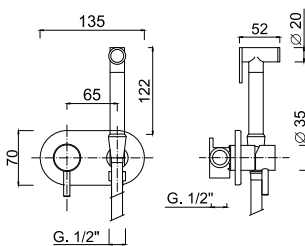

**Miscelatore monocomando per bidet, con piastra**

*Single-lever mixer for bidet with plate.  
Mitigeur pour bidet avec plaque.  
Einhebelmischer für Bidet mit Platte.  
Monomando para bidé con placa.  
однокомандный смеситель гигиенического душа с панелью*

Articolo	Note	CROMO	BO-NO-NKO	BR	O
SH27		160,00	•	•	•

**SH27/S**

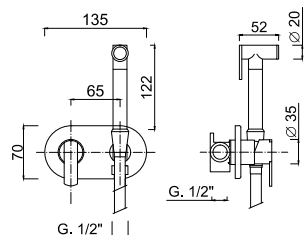

**Miscelatore monocomando per bidet, con piastra**

*Single-lever mixer for bidet with plate.  
Mitigeur pour bidet avec plaque.  
Einhebelmischer für Bidet mit Platte.  
Monomando para bidé con placa.  
однокомандный смеситель гигиенического душа с панелью*

Articolo	Note	CROMO	BO-NO-NKO	BR	O
SH27/S		175,00	•	•	•

**SH01**

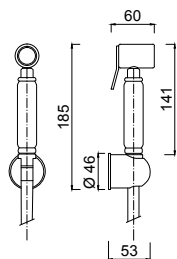

**Doccia ottone - Supporto ABS - Flex doppia aggiratura.**

*Brass shower - ABS Wall bracket Double clutching flex hose.  
Douchette en laiton, soporte ABS, flexible laiton double agrafage.  
Messing-Brause - ABS Wandbrausehalter - Messing-Brauseschlauch  
Ducha en laton, soporte en ABS, tubo flexible laton doble grapado.  
Душевая лейка латунь Опора для душа АБС Душевой шланг двойная фальцовка*

Articolo	Note	CROMO	BO-NO-NKO	BR	O
SH01		98,00	•	•	•

**SH02**

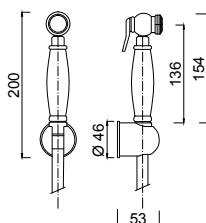

**Doccia ottone - Supporto ABS - Flex doppia aggiratura.**

*Brass shower - ABS Wall bracket Double clutching flex hose.  
Douchette en laiton, soporte ABS, flexible laiton double agrafage.  
Messing-Brause - ABS Wandbrausehalter - Messing-Brauseschlauch  
Ducha en laton, soporte en ABS, tubo flexible laton doble grapado.  
Душевая лейка латунь Опора для душа АБС Душевой шланг двойная фальцовка*

Articolo	Note	CROMO	BO-NO-NKO	BR	O
SH02		98,00	•	•	•

**SH03Q**

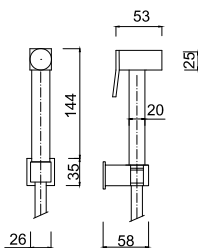

**Doccia ottone - Supporto ottone flex doppia aggraffatura.**  
Brass shower - Brass Wall bracket Double clutching flex hose.  
Douchette en laiton, support laiton, flexible laiton double agrafage.  
Messing-Brause - Messing Wandbrausehalter - Messing-Brauseschlauch.  
Ducha en laton, soporte en laton, tubo flexible laton doble grapado.  
Душевая лейка латунь Опора для душа латунь Душевой шланг двойная фальцовка.

Articolo	Note	CROMO	BO-NO-NKO	BR	O
SH03Q		110,00	•	•	•

**SH03**

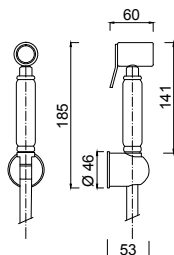

**Doccia ottone - Supporto ottone flex doppia aggraffatura.**  
Brass shower - Brass Wall bracket Double clutching flex hose.  
Douchette en laiton, support laiton, flexible laiton double agrafage.  
Messing-Brause - Messing Wandbrausehalter - Messing-Brauseschlauch.  
Ducha en laton, soporte en laton, tubo flexible laton doble grapado.  
Душевая лейка латунь Опора для душа латунь Душевой шланг двойная фальцовка.

Articolo	Note	CROMO	BO-NO-NKO	BR	O
SH03		125,00	•	194,00	240,00

**SH04**

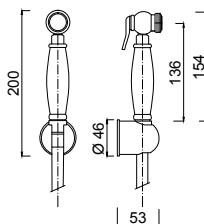

**Doccia ottone - Supporto ottone flex doppia aggraffatura.**  
Brass shower - Brass Wall bracket Double clutching flex hose.  
Douchette en laiton, support laiton, flexible laiton double agrafage.  
Messing-Brause - Messing Wandbrausehalter - Messing-Brauseschlauch.  
Ducha en laton, soporte en laton, tubo flexible laton doble grapado.  
Душевая лейка латунь Опора для душа латунь Душевой шланг двойная фальцовка.

Articolo	Note	CROMO	BO-NO-NKO	BR	O
SH04		125,00	•	194,00	240,00

**SH05Q**

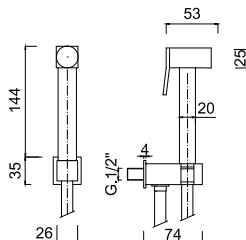

**Doccia ottone - Supporto/presa acqua ottone - Flex doppia aggraffatura.**  
Brass shower - Brass Wall bracket/water outlet - Double clutching flex hose.  
Douchette en laiton, support/prise d'eau laiton, flexible laiton double agrafage.  
Messing-Brause - Messing Wandbrausehalter/Wandanschlußbogen für Brauseanschluß - Messing-Brauseschlauch.  
Ducha en laton, soporte/toma de agua en laiton, tubo flexible laton doble grapado.  
Душевая лейка латунь Опора для душа/вывод воды латунь Душевой шланг двойная фальцовка.

Articolo	Note	CROMO	BO-NO-NKO	BR	O
SH05Q		128,00	•	•	•

**SH05**

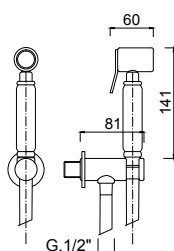

**Doccia ottone - Supporto/presa acqua ottone - Flex doppia aggraffatura.**  
Brass shower - Brass Wall bracket/water outlet - Double clutching flex hose.  
Douchette en laiton, support/prise d'eau laiton, flexible laiton double agrafage.  
Messing-Brause - Messing Wandbrausehalter/Wandanschlußbogen für Brauseanschluß - Messing-Brauseschlauch.  
Ducha en laton, soporte/toma de agua en laiton, tubo flexible laton doble grapado.  
Душевая лейка латунь Опора для душа/вывод воды латунь Душевой шланг двойная фальцовка.

Articolo	Note	CROMO	BO-NO-NKO	BR	O
SH05		145,00	•	236,00	270,00



SH06

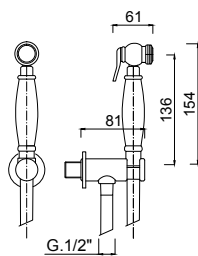

**Doccia ottone - Supporto/presa acqua ottone - Flex doppia aggaffatura.**

Brass shower - Brass Wall bracket/water outlet - Double clutching flex hose.

Douchette en laiton, support/prise d'eau laiton, flexible laiton double agrafage.

Messing-Brause - Messing Wandbrausehalter/Wandanschlußbogen für Brauseanschluß. - Messing-Brauseschlauch.

Ducha en laton, soporte/toma de agua en laiton, tubo flexible laton doble grapado.

Душевая лейка латунь Опора для душа/вывод воды латунь Душевой шланг двойная фальцовка.

Articolo	Note	CROMO	BO-NO-NKO	BR	O
SH06		145,00	•	236,00	270,00

SH07

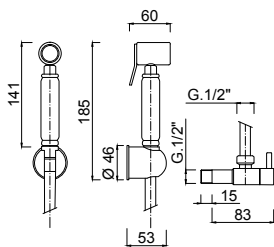

**Doccia ottone, manopola Abs - Supporto Abs - Flex doppia aggaffatura cm.150 - Rubinetto apri chiudi.**

Brass hand-shower, ABS Handle and lever - ABS holder - Double clutching flex hose cm.150 - Open/close tap.

Douchette en laiton avec poignée/manette en ABS, support mural en ABS, flexible en laiton double agrafage cm.150, robinet ouvert/fermé.

Messing-Handbrause, ABS-Griff und -Hebel, ABS-Wandbrausehalter, cm.150 Messing-Brauseschlauch, Armatur zum Schließen/Öffnen.

Ducha de mano en latón con maneta/empuñadura en ABS, soporte mural de ABS, flexos latón doble engatillado cm.150, grifo abierto/cerrado.

Душевая лейка латунь, ручка ABS - Опора для душа латунь Душевой душ латунный, ручка ABS - крепление ABS- шланг двойная фальцовка длиной 150 см. Кнопка включения воды

Articolo	Note	CROMO	BO-NO-NKO	BR	O
SH07		95,00	•	•	•

1787

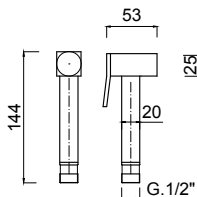

**Doccetta SHUTT OFF**

Hand-shower SHUT OFF

Douchette SHUT OFF

Dusche SHUTT OFF

Ducha SHUTT OFF

Душевая лейка SHUT OFF

Articolo	Note	CROMO	BO-NO-NKO	BR	O
1787		55,00	•	•	

1790

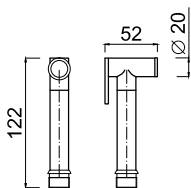

**Doccetta SHUTT OFF**

Hand-shower SHUT OFF

Douchette SHUT OFF

Dusche SHUTT OFF

Ducha SHUTT OFF

Душевая лейка SHUT OFF

Articolo	Note	CROMO	BO-NO-NKO	BR	O
1790		30,00	•	•	

1791

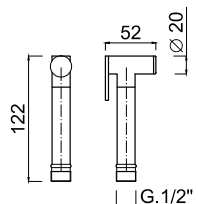

**Doccetta SHUTT OFF**

Hand-shower SHUT OFF

Douchette SHUT OFF

Dusche SHUTT OFF

Ducha SHUTT OFF

Душевая лейка SHUT OFF

Articolo	Note	CROMO	BO-NO-NKO	BR	O
1791		37,00	82,00	•	

1793

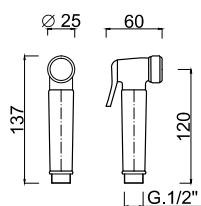

**Doccetta SHUTT OFF**  
Hand-shower SHUT OFF  
Douchette SHUT OFF  
Dusche SHUTT OFF  
Ducha SHUTT OFF  
Душевая лейка SHUT OFF

Articolo	Note	CROMO	BO-NO-NKO	BR	O
1793		44,00	•	89,00	107,00

1531

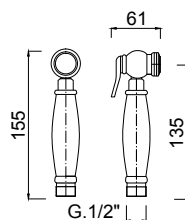

**Doccetta SHUTT OFF**  
Hand-shower SHUT OFF  
Douchette SHUT OFF  
Dusche SHUTT OFF  
Ducha SHUTT OFF  
Душевая лейка SHUT OFF

Articolo	Note	CROMO	BO-NO-NKO	BR	O
1531		82,00	•	103,00	125,00

1532

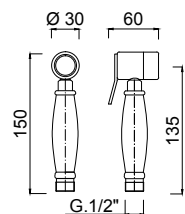

**Doccetta SHUTT OFF**  
Hand-shower SHUT OFF  
Douchette SHUT OFF  
Dusche SHUTT OFF  
Ducha SHUTT OFF  
Душевая лейка SHUT OFF

Articolo	Note	CROMO	BO-NO-NKO	BR	O
1532		82,00	•	103,00	125,00

1573-12

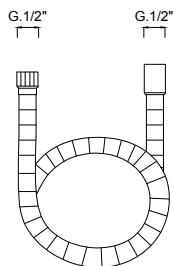

**Flessibile ottone doppia aggraffatura cm.120 CC.**  
Flexible brass hose cm. 120 doubleinterlock.  
Flexible laiton double agrafage cm 120.  
Messing-Brauseschlauch cm120.  
Flexible latòn doble grapado cm 120.  
Гибкий шланг 120 см с двойным зажимом

Articolo	Note	CROMO	BO-NO-NKO	BR	O
1573-12		17,00	•	30,00	65,00

1730-12

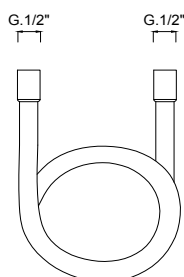

**Flessibile girevole cm.120 in PVC.**  
PVC flexible, cm.120.  
Flexible en PVC, cm.120.  
PVC Brauseschlauch, cm.120.  
Tubo flexible en PVC, cm.120.  
Гибкий шланг, 120 см.

Articolo	Note	CROMO	BO-NO-NKO	BR	O
1730-12		28,00	28,00	•	•



## PARTI INCASSO / BUILT-IN MIXER

	<b>CODICE 5250</b>	<b>CODICE 5252</b>	<b>CODICE 5254</b>	<b>CODICE 5256</b>	<b>CODICE 5258</b>	<b>CODICE 5260</b>
	Corpo incasso Ø 40	Corpo incasso, cartuccia Ecosave	Corpo incasso Ø 35	Corpo incasso Ø 35	Corpo incasso, cartuccia progressiva	Corpo incasso, cartuccia progressiva
	<i>Built-in mixer body, Ø 40</i>	<i>Built-in mixer body, Ecosave cartridge</i>	<i>Built-in mixer body, Ø 35</i>	<i>Built-in mixer body, Ø 35</i>	<i>Built-in mixer body, progressive cartridge</i>	<i>Built-in mixer body, progressive cartridge</i>
	listino cromo € 50,00	listino cromo € 50,00	listino cromo € 50,00	listino cromo € 50,00	listino cromo € 50,00	listino cromo € 50,00



## PARTI ESTERNE PER MIX INCASSO / EXTERNAL PARTS FOR BUILT-IN MIXER

COLLEZIONI	ARTICOLO					
INFINITO	8515-EP	€ 30,00				
SPAZIO	8615-EP	€ 30,00				
ROMA	2615-EP	€ 33,00				
KELLY	2515-EP	€ 30,00				
MERY	2415-EP	€ 30,00				
GOLDENLUX	0415-EP	€ 28,00				
GOLDENSTAR	1015-EP	€ 28,00				
GIADA	2215-EP	€ 18,00				
GIADALUX	2115-EP	€ 22,00				
KELLYGREEN	2915-EP		€ 33,00			
SURF	5815-EP			€ 67,00		
HERMITAGE	4415-EP			€ 85,00		
HERMITAGE CRYSTAL	4415-EP/S			€ 135,00		
MYRING	MR0015-EP			€ 71,00		
PABLOLUX	9815-EP				€ 98,00	
CORNER	6815-EP				€ 28,00	
QUACK	9115-EP				€ 41,00	
FUTURO	6515-EP				€ 32,00	
HARMONY	9515-EP				€ 39,00	
HARMONY CRYSTAL	9515-EP/S				€ 89,00	
HARMONY LEGNO	9515-EPL				€ 45,00	
HARMONY CERAMICA	9515-EPCE				€ 49,00	
SYMPHONY	4315-EP				€ 87,00	
MELODY	9415-EP				€ 19,00	
EPOCA	9315-EP				€ 19,00	
PRAGA	7515-EP				€ 39,00	
PRAGA CRYSTAL	7515-EP/S				€ 89,00	
PRAGA LEGNO	7515-EPL				€ 45,00	
PRAGA CERAMICA	7515-EPCE				€ 49,00	
LADY	6415-EP				€ 25,00	
LINEA	6315-EP				€ 25,00	
ELICA	9215-EP					€ 45,00
GIOMIX CRYSTAL	3615-EP					€ 91,00

## PARTI INCASSO / BUILT-IN MIXER



	<b>CODICE 5262</b>	<b>CODICE 5264</b>	<b>CODICE 5266</b>	<b>CODICE 5268</b>	<b>CODICE 5270</b>
	Corpo incasso Ø 40, deviatore a pulsante	Corpo incasso, deviatore a pulsante, cartuccia Ecosave	Corpo incasso Ø 35, deviatore a pulsante	Corpo incasso, deviatore a pulsante, cartuccia progressiva	Corpo incasso, deviatore a pulsante, cartuccia progressiva
	<i>Built-in mixer body, Ø 40, with diverter button</i>	<i>Built-in mixer body, Ecosave cartridge, with diverter</i>	<i>Built-in mixer body, Ø 35, with diverter button</i>	<i>Built-in mixer body, progressive cartridge, with diverter</i>	<i>Built-in mixer body, progressive cartridge, with diverter</i>
	listino € 140	listino € 140	listino € 140	listino € 140	listino € 140



## PARTI ESTERNE PER MIX INCASSO CON DEVIATORE / EXTERNAL PARTS FOR BUILT-IN MIXER WITH DIVERTER

COLLEZIONI	ARTICOLO				
INFINITO	8511-EP	€ 23,00			
SPAZIO	8611-EP	€ 23,00			
ROMA	2611-EP	€ 31,00			
KELLY	2511-EP	€ 23,00			
MERY	2411-EP	€ 23,00			
GOLDENLUX	0404-EP	€ 23,00			
GOLDENSTAR	1011-EP	€ 23,00			
GIADA	2211-EP	€ 13,00			
GIADALUX	2111-EP	€ 17,00			
KELLYGREEN	2911-EP		€ 21,00		
SURF	5813-EP			€ 58,00	
HERMITAGE	4413-EP			€ 94,00	
HERMITAGE CRYSTAL	4413-EP/S			€ 144,00	
MYRING	MR0013-EP			€ 80,00	
PABLOLUX	9813-EP			€ 111,00	
CORNER	6813-EP			€ 39,00	
QUACK	9113-EP			€ 47,00	
FUTURO	6513-EP			€ 37,00	
HARMONY	9511-EP			€ 56,00	
HARMONY CRYSTAL	9511-EP/S			€ 106,00	
HARMONY LEGNO	9511-EPL			€ 62,00	
HARMONY CERAMICA	9511-EPCE			€ 66,00	
SYMPHONY	4311-EP			€ 106,00	
MELODY	9411EP			€ 31,00	
EPOCA	9311EP			€ 31,00	
PRAGA	7511-EP			€ 56,00	
PRAGA CRYSTAL	7511-EP			€ 106,00	
PRAGA LEGNO	7511-EP			€ 62,00	
PRAGA CERAMICA	7511-EP			€ 66,00	
LADY	6413-EP			€ 28,00	
LINEA	6313-EP			€ 28,00	
ELICA	9213-EP				€ 52,00
GIOMIX	3513-EP				€ 94,00

### PARTI INCASSO / BUILT-IN MIXER



	<b>CODICE 5272</b>	<b>CODICE 5274</b>
	Corpo incasso con deviatore 3 vie <i>Built-in mixer body with 3-way diverter</i>	Corpo incasso con deviatore 4 vie <i>Built-in mixer body with 4-way diverter</i>
	listino € 190,00	listino € 207,00
		



### PARTI ESTERNE PER MIX INCASSO CON DEVIATORE / EXTERNAL PARTS FOR BUILT-IN MIXER WITH DIVERTER

COLLEZIONI	ARTICOLO		
<b>SURF</b>	<b>5813-3EP</b>	€ 83,00	€ 83,00
<b>MYRING</b>	<b>0013-3EP</b>	€ 102,00	€ 102,00
<b>PABLOLUX</b>	<b>9813-3EP</b>	€ 153,00	€ 153,00
<b>FUTURO</b>	<b>6513-3EP</b>	€ 79,00	€ 79,00
<b>HARMONY</b>	<b>9511-3EP</b>	€ 91,00	€ 91,00
<b>HARMONY CRYSTAL</b>	<b>9511-3EP/S</b>	€ 141,00	€ 141,00
<b>HARMONY LEGNO</b>	<b>9511-3EPL</b>	€ 97,00	€ 97,00
<b>HARMONY CERAMICA</b>	<b>9511-3EPCE</b>	€ 101,00	€ 101,00
<b>SYMPHONY</b>	<b>4311-3EP</b>	€ 141,00	€ 141,00
<b>PRAGA</b>	<b>7511-3EP</b>	€ 91,00	€ 91,00
<b>PRAGA CRYSTAL</b>	<b>7511-3EP</b>	€ 141,00	€ 141,00
<b>PRAGA LEGNO</b>	<b>7511-3EP</b>	€ 97,00	€ 97,00
<b>PRAGA CERAMICA</b>	<b>7511-3EP</b>	€ 101,00	€ 101,00

## PARTI INCASSO / BUILT-IN DIVERTER

	<b>CODICE 0041-12</b>	Corpo deviatore 3 vie (1 entrata + 2 uscite) <i>3-ways diverter body (1 inlet + 2 outlets)</i>	listino € 80,00
	<b>CODICE 0041-13</b>	Corpo deviatore 4 vie (1 entrata + 3 uscite) <i>4-ways diverter body (1 inlet + 3 outlets)</i>	listino € 90,00
	<b>CODICE 0041-14</b>	Corpo deviatore 5 vie (1 entrata + 4 uscite) <i>5-ways diverter body (1 inlet + 4 outlets)</i>	listino € 115,00
	<b>CODICE 0041-22</b>	Corpo deviatore 4 vie (2 entrata + 2 uscite) <i>4-ways diverter body (2 inlet + 2 outlets)</i>	listino € 90,00
	<b>CODICE 0041-23</b>	Corpo deviatore 5 vie (2 entrata + 3 uscite) <i>5-ways diverter body (2 inlet + 3 outlets)</i>	listino € 120,00
	<b>CODICE 0040</b>	Corpo deviatore bordo vasca <i>Deck mounted diverter body</i>	listino € 85,00

+

## PARTI ESTERNE PER DEVIATORE / EXTERNAL PARTS FOR DIVERTER

	ARTICOLO	COLLEZIONI	CROMO	BO NO NKO	BR	O
	3290-PB	PABLOLUX	€ 125,00	€ 150,00	x	x
	3290-G4	G4	€ 35,00	€ 50,00		
	3290-PR	PRAGA	€ 40,00	x	€ 55,00	€ 65,00
	3290-PRC	PRAGA CRYSTAL	€ 90,00	x	€ 105,00	€ 115,00
	3290-PRL	PRAGA LEGNO	€ 46,00	x	€ 61,00	€ 71,00
	3290-PRCE	PRAGA CERAMICA	€ 50,00	x	€ 65,00	€ 75,00
	3290-LN	LONDRA	€ 36,00	x	€ 51,00	€ 61,00









Erica



**RG0403**

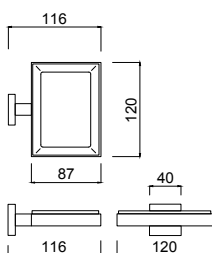

**Porta sapone da parete.**

Soap-holder.  
Porte-savon.  
Seifenschale.  
Jabonera.  
Мыльница.

Articolo	Note	CROMO	BO-NO	NKO	
<b>RG0403</b>		183,00	219,00	246,00	

**RG0436**

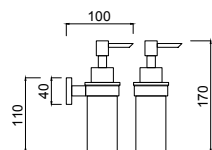

**Porta dispenser da parete.**

Liquid-soap dispenser.  
Doseur pour savon liquide.  
Seifenspenderhalter.  
Dosificator de jabon liquido.  
Диспенсер

Articolo	Note	CROMO	BO-NO	NKO	
<b>RG0436</b>		147,00	175,00	196,00	

**RG0406**

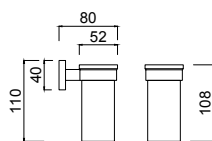

**Porta bicchiere da parete.**

Cup-holder.  
Porte-verre.  
Glashalter.  
Portavaso.  
Стакан.

Articolo	Note	CROMO	BO-NO	NKO	
<b>RG0406</b>		109,00	130,00	145,00	

**RG0409**

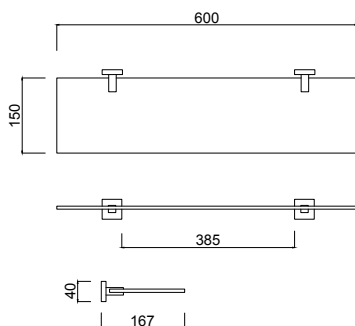

**Mensola in vetro.**

Glass-shelf.  
Etagère en verre.  
Ablage.  
Repisa en vidrio.  
Полка стеклянная.

Articolo	Note	CROMO	BO-NO	NKO	
<b>RG0409</b>		235,00	315,00	280,00	

**RG0412**

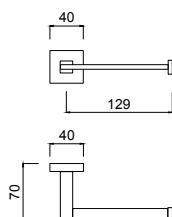

**Porta rotolo.**

Roll-holder.  
Porte-rouleau.  
Papierhalter.  
Portarollo.  
Бумагодержатель.

Articolo	Note	CROMO	BO-NO	NKO	
<b>RG0412</b>		101,00	120,00	135,00	

**RG0413**

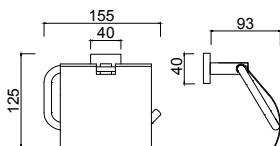

**Porta rotolo con coperchio**  
Covered toilet roll holder  
Porte-papier couvert  
Papierrollenhalter mit Deckel  
Portarrollos con tapa  
Держатель туалетной бумаги с крышкой

Articolo	Note	CROMO	BO-NO	NKO	
<b>RG0413</b>		145,00	173,00	194,00	

**RG0415**

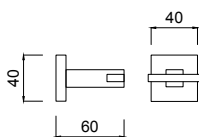

**Appendiabito.**  
Clothes hanger.  
Patère.  
Haken.  
Colgador.  
Крючок одинарный

Articolo	Note	CROMO	BO-NO	NKO	
<b>RG0415</b>		82,00	97,00	109,00	

**RG0416**

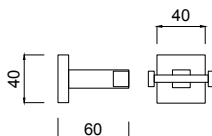

**Appendiabito doppio**  
Double hook  
Porte-peignoir double  
Doppel-Kleiderhaken  
Percha doble  
Двойной крючок

Articolo	Note	CROMO	BO-NO	NKO	
<b>RG0416</b>		101,00	120,00	135,00	

**RG0425**

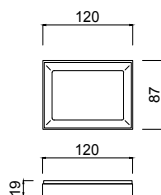

**Porta sapone da appoggio.**  
Free-standing soap-holder.  
Porte-savon d'appui.  
Seifenschale.  
Jabonera d'appoyo.  
Мыльница

Articolo	Note	CROMO	BO-NO	NKO	
<b>RG0425</b>		126,00	151,00	185,00	

**RG0428**



**Porta bicchiere da appoggio.**  
Free-standing cup-holder.  
Porte-verre d'appui.  
Becher.  
Portavasos d'appoyo.  
Держатель для стакана

Articolo	Note	CROMO	BO-NO	NKO	
<b>RG0428</b>		116,00	139,00	156,00	

RG0429

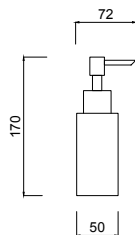

**Porta dispenser da appoggio.**  
Standing dispenser holder.  
Distributeur de savon à poser.  
Seifenspender standmodell.  
Suporte para dispensador de savon.  
Держатель диспенсера.

Articolo	Note	CROMO	BO-NO	NKO	
RG0429		149,00	177,00	200,00	

RG0430

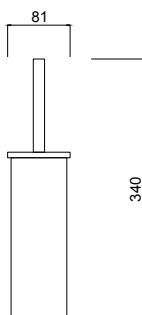

**Porta scopino da appoggio.**  
Free-standing brush-holder.  
Porte-balayette d'appui.  
Toilettebürstehalter.  
Portacepillo d'appoggio.  
Ерш напольный.

Articolo	Note	CROMO	BO-NO	NKO	
RG0430		296,00	353,00	397,00	

RG0433

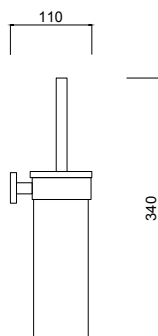

**Porta scopino da parete con coperchio.**  
Wall brush-holder with lid.  
Porte-balayette au mur avec couvercle.  
Wandbürstengarnitur.  
Portacepillo de pared con tapa.  
Ерш подвесной с крышкой.

Articolo	Note	CROMO	BO-NO	NKO	
RG0433		221,00	265,00	298,00	

RG0448

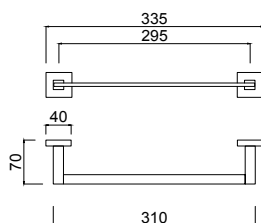

**Porta salviette bidet.**  
Towel-rack.  
Porte-serviettes.  
Handtuchhalter.  
Тоаллеро.  
Полотенцедержатель.

Articolo	Note	CROMO	BO-NO	NKO	
RG0448		168,00	200,00	225,00	

RG0452

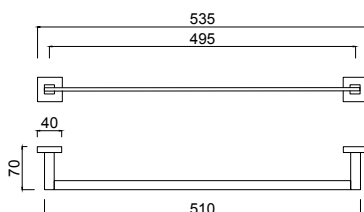

**Porta salviette.**  
Towel-rack.  
Porte-serviettes.  
Handtuchhalter.  
Тоаллеро.  
Полотенцедержатель.

Articolo	Note	CROMO	BO-NO	NKO	
RG0452		181,00	217,00	244,00	





Moderna





**RG0803**

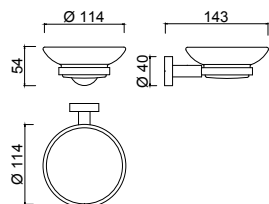

**Porta sapone da parete.**

Soap-holder.  
Porte-savon.  
Seifenschale.  
Jabonera.  
Мыльница.

Articolo	Note	CROMO	BO-NO	NKO
<b>RG0803</b>		80,00	95,00	106,00

**RG0803A**

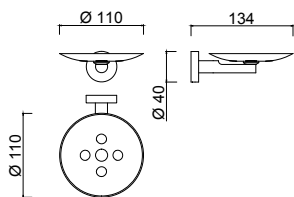

**Porta sapone. ACCIAIO**

Soap-holder.  
Porte-savon.  
Seifenschale.  
Jabonera.  
Мыльница.

Articolo	Note	CROMO	BO-NO	NKO
<b>RG0803A</b>		103,00	122,00	137,00

**RG0836**

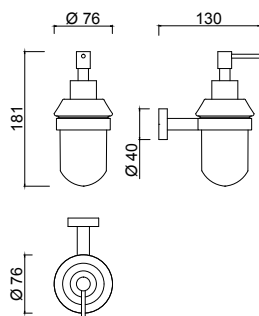

**Porta dispenser da parete.**

Liquid-soap dispenser.  
Doseur pour savon liquide.  
Seifenspenderhalter.  
Dosificator de jabon liquido.  
Диспенсер

Articolo	Note	CROMO	BO-NO	NKO
<b>RG0836</b>		132,00	157,00	176,00

**RG0836A**

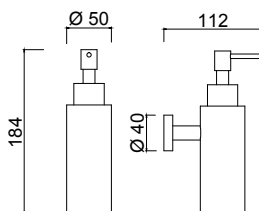

**Porta dispenser da parete acciaio.**

Liquid-soap dispenser.  
Doseur pour savon liquide.  
Seifenspenderhalter.  
Dosificator de jabon liquido.  
Диспенсер

Articolo	Note	CROMO	BO-NO	NKO
<b>RG0836A</b>		141,00	168,00	189,00

**RG0806**

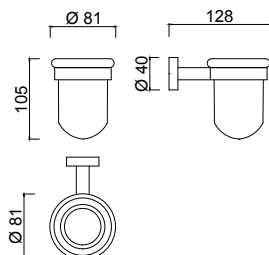

**Porta bicchiere da parete.**

Cup-holder.  
Porte-verre.  
Glashalter.  
Portavasos.  
Стакан.

Articolo	Note	CROMO	BO-NO	NKO
<b>RG0806</b>		80,00	95,00	106,00

**RG0809**

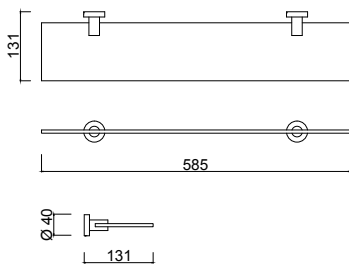

**Mensola in vetro.**  
Glass-shelf.  
Etagère en verre.  
Ablage.  
Repisa en vidrio.  
Полка стеклянная.

Articolo	Note	CROMO	BO-NO	NKO	
<b>RG0809</b>		189,00	225,00	253,00	

**RG0812**

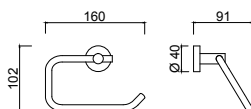

**Porta rotolo.**  
Roll-holder.  
Porte-rouleau.  
Papierhalter.  
Portarollo.  
Бумагодержатель.

Articolo	Note	CROMO	BO-NO	NKO	
<b>RG0812</b>		72,00	86,00	96,00	

**RG0813**

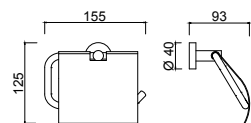

**Porta rotolo con coperchio**  
Covered toilet roll holder  
Porte-papier couvert  
Papierrollenhalter mit Deckel  
Portarollos con tapa  
Держатель туалетной бумаги с крышкой

Articolo	Note	CROMO	BO-NO	NKO	
<b>RG0813</b>		107,00	127,00	142,00	

**RG0815**

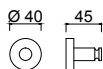

**Appendiabito.**  
Clothes hanger.  
Patère.  
Haken.  
Colgador.  
Крючок одинарный

Articolo	Note	CROMO	BO-NO	NKO	
<b>RG0815</b>		36,00	42,00	47,00	

**RG0825A**

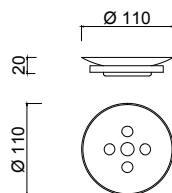

**Porta sapone da appoggio. ACCIAIO**  
Free-standing soap-holder.  
Porte-savon d'appui.  
Seifenschale.  
Jabonera d'apoyo.  
Мыльница.



Articolo	Note	CROMO	BO-NO	NKO	
<b>RG0825A</b>		84,00	99,00	111,00	

**RG0828A**

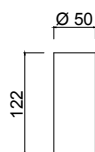

**Porta bicchiere da appoggio. ACCIAIO**

*Free-standing cup-holder.  
Porte-verre d'appui.  
Becher.  
Portavasos d'apoyo.  
Держатель для стакана.*

Articolo	Note	CROMO	BO-NO	NKO	
<b>RG0828A</b>		61,00	72,00	80,00	

**RG0829A**

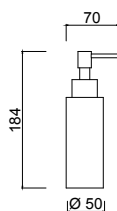

**Porta dispenser da appoggio. ACCIAIO**

*Standing dispenser holder.  
Distributeur de savon à poser.  
Seifenspender standmodell.  
Suporte para dispensador de savon.  
Держатель диспенсера.*

Articolo	Note	CROMO	BO-NO	NKO	
<b>RG0829A</b>		114,00	136,00	152,00	

**RG0830A**

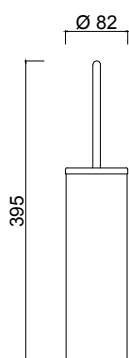

**Porta scopino da appoggio. ACCIAIO**

*Free-standing brush-holder.  
Porte-balayette d'appui.  
Toilettebürstehalter.  
Portacepillo d'apoyo.  
Ерш напольный.*

Articolo	Note	CROMO	BO-NO	NKO	
<b>RG0830A</b>		143,00	170,00	191,00	

**RG0833**

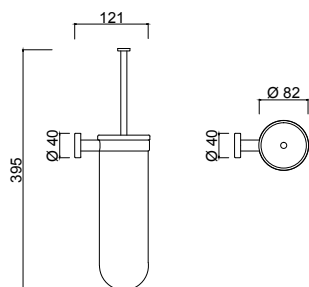

**Porta scopino da parete con coperchio.**

*Wall brush-holder with lid.  
Porte-balayette au mur avec couvercle.  
Wandbürstengarnitur.  
Portacepillo de pared con tapa.  
Ерш подвесной с крышкой.*

Articolo	Note	CROMO	BO-NO	NKO	
<b>RG0833</b>		139,00	166,00	186,00	

**RG0818**

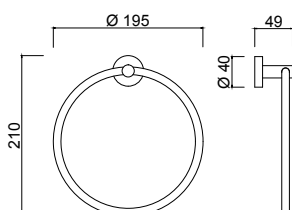

**Porta salviette ad anello.**

*Ring shaped towel-rack.  
Porte-serviettes en anneau.  
Handtuchring.  
Toallero con forma de anillo.  
Полотенцедержатель.*

Articolo	Note	CROMO	BO-NO	NKO	
<b>RG0818</b>		63,00	74,00	83,00	

RG0821

**Porta salviette snodato.**  
*Jointed towel-rack.*  
*Porte-serviettes orientable.*  
*Handtuchhalter.*  
*Toallero articulado.*  
*Полотенцедержатель.*

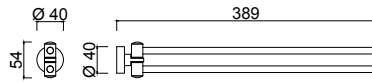

Articolo	Note	CROMO	BO-NO	NKO	
<b>RG0821</b>		160,00	191,00	214,00	

RG0848

**Porta salviette bidet.**  
*Towel-rack.*  
*Porte-serviettes.*  
*Handtuchhalter.*  
*Toallero.*  
*Полотенцедержатель.*

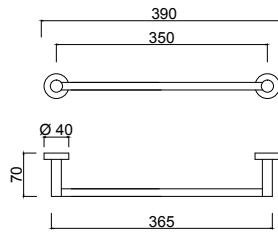

Articolo	Note	CROMO	BO-NO	NKO	
<b>RG0848</b>		114,00	136,00	152,00	

RG0852

**Porta salviette.**  
*Towel-rack.*  
*Porte-serviettes.*  
*Handtuchhalter.*  
*Toallero.*  
*Полотенцедержатель.*

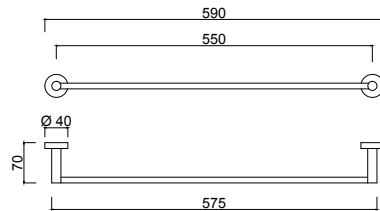

Articolo	Note	CROMO	BO-NO	NKO	
<b>RG0852</b>		120,00	143,00	160,00	

RG0861

**Griglia angolare**  
*Corner basket soap holder*  
*Panier porte-savon d'angle*  
*Eckseifenkorb für Dusche*  
*Jabonera esquina*  
*Угловая решетка для мыла*

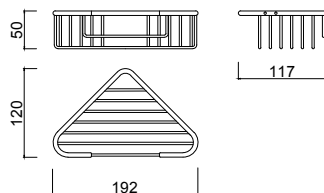

Articolo	Note	CROMO	BO-NO	NKO	
<b>RG0861</b>		101,00	120,00	134,00	

**RG0865**

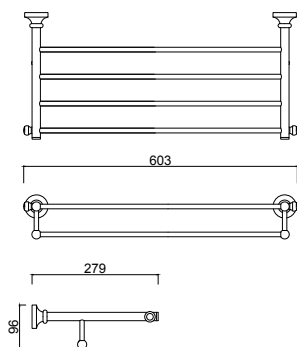

**Portasciugamani**

Towel holder  
Porte-serviette  
Handtuchhalter  
Toallero  
Полотенцедержатель

Articolo	Note	CROMO	BO-NO	NKO	
<b>RG0865</b>		324,00	388,00	436,00	

**RGP0003**

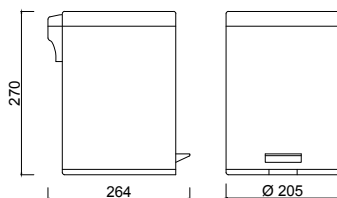

**PATTUMIERA A PEDALE 3 LT**

Pedal bin 3 lt  
Poubelle à pédale 3 lt  
Mülleimer 3 lt  
Papelera de pedal 3 lt  
Мусорная корзина с педалью, 3 л.

Articolo	Note	CROMO	BO-NO	NKO	
<b>RGP0003</b>	3LT	59,00	196,00	231,00	
<b>RGP0005</b>	5LT	95,00	251,00	285,00	





# Ibisco Crystal Ibisco Ceramica

Crystals from Swarovski®





**RG1103/S**

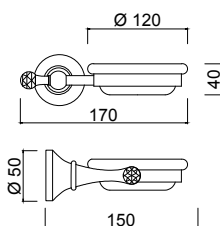

**Porta sapone da parete.**

Soap-holder.  
Porte-savon.  
Seifenschale.  
Jabonera.  
Мыльница.

Articolo	Note	CROMO	BR	O
<b>RG1103/S</b>		143,00	165,00	182,00
<b>RG1103CE</b>	CE	143,00	165,00	182,00

**RG1136/S**

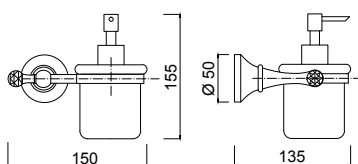

**Porta dispenser da parete.**

Liquid-soap dispenser.  
Doseur pour savon liquide.  
Seifenspenderhalter.  
Dosificator de jabon liquido.  
Диспенсер

Articolo	Note	CROMO	BR	O
<b>RG1136/S</b>		203,00	226,00	258,00
<b>RG1136CE</b>	CE	203,00	226,00	258,00

**RG1106/S**

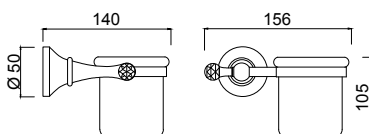

**Porta bicchiere da parete.**

Cup-holder.  
Porte-verre.  
Glashalter.  
Portavasos.  
Стакан.

Articolo	Note	CROMO	BR	O
<b>RG1106/S</b>		143,00	165,00	182,00
<b>RG1106CE</b>	CE	143,00	165,00	182,00

**RG1109/S**

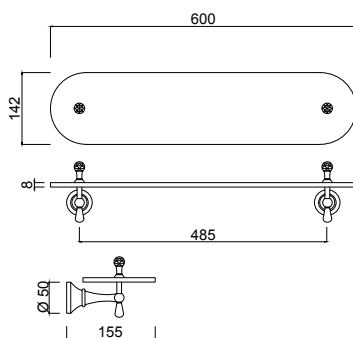

**Mensola in vetro.**

Glass-shelf.  
Etagère en verre.  
Ablage.  
Repisa en vidrio.  
Полка стеклянная.

Articolo	Note	CROMO	BR	O
<b>RG1109/S</b>		370,00	416,00	467,00
<b>RG1109CE</b>	CE	370,00	416,00	467,00

**RG1112/S**

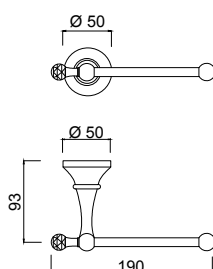

**Porta rotolo.**

Roll-holder.  
Porte-rouleau.  
Papierhalter.  
Portarollo.  
Бумагодержатель.

Articolo	Note	CROMO	BR	O
<b>RG1112/S</b>		111,00	123,00	138,00
<b>RG1112CE</b>	CE	111,00	123,00	138,00

**RG1113/S**

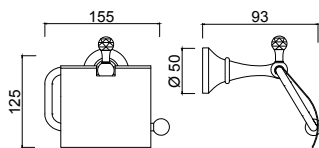

**Porta rotolo con coperchio**

Covered toilet roll holder  
Porte-papier couvert  
Papierrollenhalter mit Deckel  
Portarrollos con tapa  
Держатель туалетной бумаги с крышкой

Articolo	Note	CROMO	BR	O
<b>RG1113/S</b>		185,00	205,00	241,00
<b>RG1113CE</b>	CE	185,00	205,00	241,00

**RG1115/S**

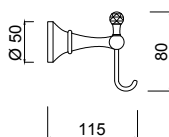

**Appendiabito.**

Clothes hanger.  
Patère.  
Haken.  
Colgador.  
Крючок одинарный

Articolo	Note	CROMO	BR	O
<b>RG1115/S</b>		90,00	102,00	119,00
<b>RG1115CE</b>	CE	90,00	102,00	119,00

**RG1116/S**

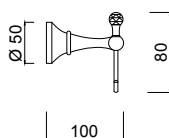

**Appendiabito doppio**

Double hook  
Porte-peignoir double  
Doppel-Kleiderhaken  
Percha doble  
Двойной крючок

Articolo	Note	CROMO	BR	O
<b>RG1116/S</b>		94,00	106,00	119,00
<b>RG1116CE</b>	CE	94,00	106,00	119,00

**RG1128/S**

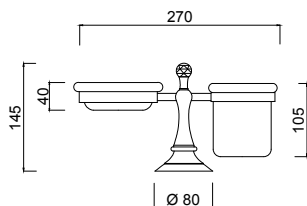

**Porta sapone/bicchieri da appoggio.**

Free-standing soap/cup-holder.  
Porte-savon/verre d'appui.  
Seifenschale mit Becherhalter.  
Jabonera/portavaso d'appoyo.  
Держатель со стаканом и мыльницей настольный.

Articolo	Note	CROMO	BR	O
<b>RG1128/S</b>		237,00	266,00	304,00
<b>RG1128CE</b>	CE	237,00	266,00	304,00

**RG1129/S**

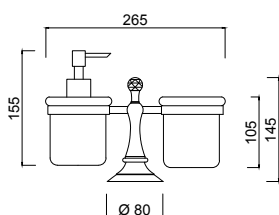

**Porta dispenser/bicchieri da appoggio.**

Free-standing dispenser/cup-holder.  
Doseur pour savon liquide et porte verre d'appui.  
Seifenspender/Becher.  
Dosifi cator de jabón líquido y portavaso d'appoyo.  
Держатель с диспенсером и стаканом настольны

Articolo	Note	CROMO	BR	O
<b>RG1129/S</b>		296,00	331,00	381,00
<b>RG1129CE</b>	CE	296,00	331,00	381,00

**RG1130/S**

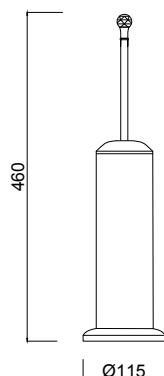

**Porta scopino da appoggio. ACCIAIO**

Free-standing brush-holder.  
Porte-balayette d'appui.  
Toilettebürstehalter.  
Portacepillo d'appoggio.  
Ерш напольный.

Articolo	Note	CROMO	BR	O
<b>RG1130/S</b>		204,00	224,00	255,00
<b>RG1130CE</b>	CE	204,00	224,00	255,00

**RG1133/S**

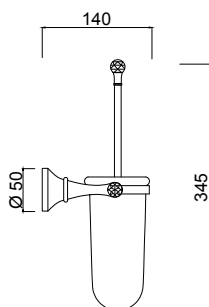

**Porta scopino da parete con coperchio.**

Wall brush-holder with lid.  
Porte-balayette au mur avec couvercle.  
Wandbürstengarnitur.  
Portacepillo de pared con tapa.  
Ерш подвесной с крышкой.

Articolo	Note	CROMO	BR	O
<b>RG1133/S</b>		249,00	278,00	313,00
<b>RG1133CE</b>	CE	249,00	278,00	313,00

**RG1118/S**

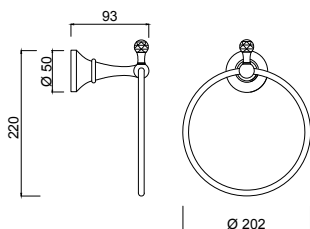

**Porta salviette ad anello.**

Ring shaped towel-rack.  
Porte-serviettes en anneau.  
Handtuchring.  
Toallero con forma de anillo.  
Полотенцедержатель.

Articolo	Note	CROMO	BR	O
<b>RG1118/S</b>		97,00	110,00	121,00
<b>RG1118CE</b>	CE	97,00	110,00	121,00

**RG1121/S**

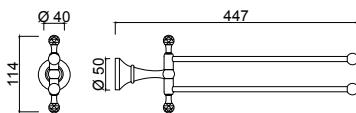

**Porta salviette snodato.**

Jointed towel-rack.  
Porte-serviettes orientable.  
Handtuchhalter.  
Toallero articulado.  
Полотенцедержатель.

Articolo	Note	CROMO	BR	O
<b>RG1121/S</b>		222,00	250,00	282,00
<b>RG1121CE</b>	CE	222,00	250,00	282,00

**RG1148/S**

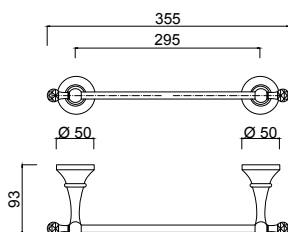

**Porta salviette bidet.**

Towel-rack.  
Porte-serviettes.  
Handtuchhalter.  
Toallero.  
Полотенцедержатель.

Articolo	Note	CROMO	BR	O
<b>RG1148/S</b>		195,00	219,00	248,00
<b>RG1148CE</b>	CE	195,00	219,00	248,00

**RG1152/S**

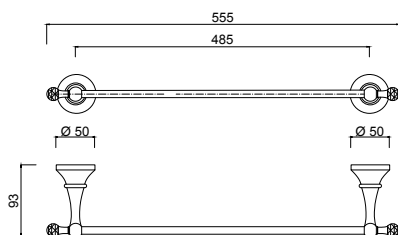

**Porta salviette.**  
*Towel-rack.*  
*Porte-serviettes.*  
*Handtuchhalter.*  
*Toallero.*  
*Полотенцедержатель.*

Articolo	Note	CROMO	BR	O
<b>RG1152/S</b>		205,00	231,00	259,00
<b>RG1152CE</b>	CE	205,00	231,00	259,00

**RG1160/S**

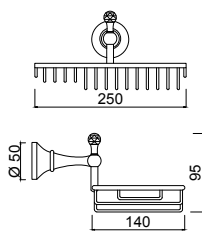

**Griglia porta spugna**  
*Basket soap holder*  
*Panier porte-savon*  
*Schwammkorb*  
*Jabonera*  
*Решетка для мыла*

Articolo	Note	CROMO	BR	O
<b>RG1160/S</b>		168,00	190,00	216,00
<b>RG1160CE</b>	CE	168,00	190,00	216,00

**RGP0003**

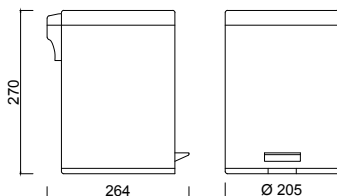

**Pattumiera a pedale 3 lt**  
*Pedal bin 3 lt*  
*Poubelle à pedale 3 lt*  
*Mülleimer 3 lt*  
*Papelera de pedal 3 lt*  
*Мусорная корзина с педалью, 3 л.*

Articolo	Note	CROMO	BR	O
<b>RGP0003</b>	3LT	59,00	196,00	231,00
<b>RGP0005</b>	5LT	95,00	251,00	285,00



**SWAROVSKI LIGHT**



**CE - CERAMICA BIANCA**



**CE - CERAMICA NERA**



Ibisco

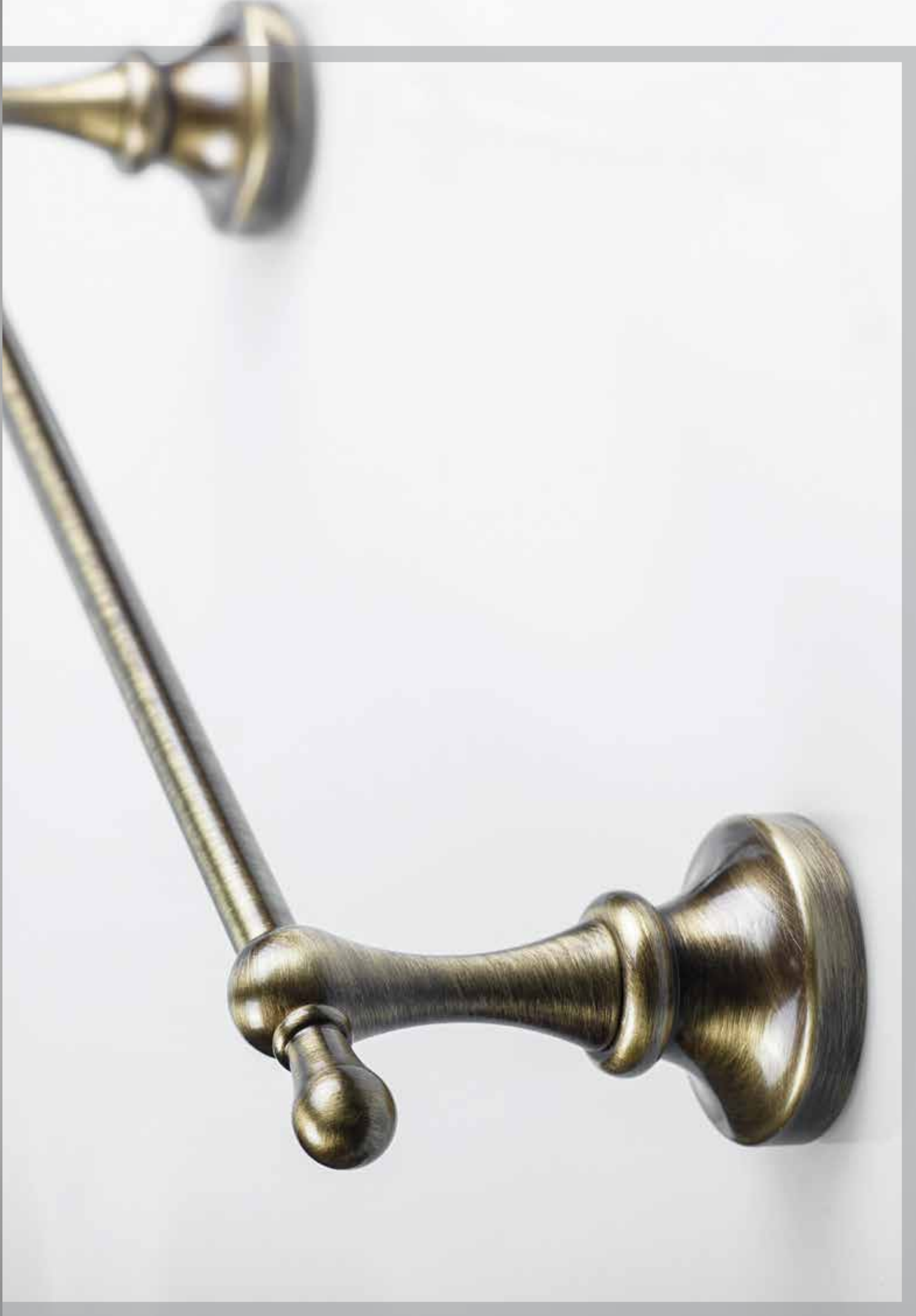

**RG1103**

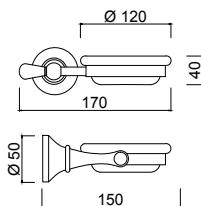

**Porta sapone da parete.**  
Soap-holder.  
Porte-savon.  
Seifenschale.  
Jabonera.  
Мыльница.

Articolo	Note	CROMO	BR	O	
<b>RG1103</b>		128,00	148,00	167,00	

**RG1136**

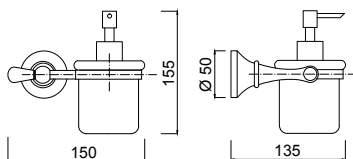

**Porta dispenser da parete.**  
Liquid-soap dispenser.  
Doseur pour savon liquide.  
Seifenspenderhalter.  
Dosificator de jabon liquido.  
Диспенсер

Articolo	Note	CROMO	BR	O	
<b>RG1136</b>		188,00	210,00	243,00	

**RG1106**

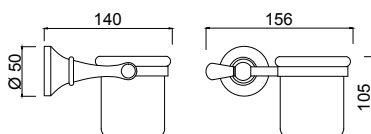

**Porta bicchiere da parete.**  
Cup-holder.  
Porte-verre.  
Glashalter.  
Portavaso.  
Стакан.

Articolo	Note	CROMO	BR	O	
<b>RG1106</b>		128,00	148,00	167,00	

**RG1109**

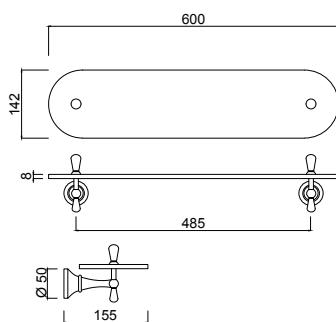

**Mensola in vetro.**  
Glass-shelf.  
Étagère en verre.  
Ablage.  
Repisa en vidrio.  
Полка стеклянная.

Articolo	Note	CROMO	BR	O	
<b>RG1109</b>		310,00	350,00	407,00	

**RG1112**

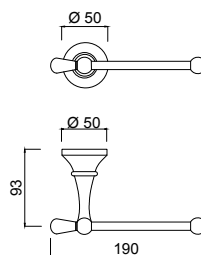

**Porta rotolo.**  
Roll-holder.  
Porte-rouleau.  
Papierhalter.  
Portarollo.  
Бумагодержатель.

Articolo	Note	CROMO	BR	O	
<b>RG1112</b>		96,00	106,00	123,00	



RG1113

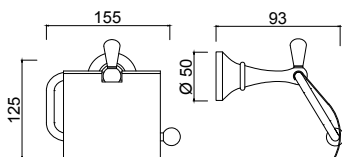

**Porta rotolo con coperchio**

Covered toilet roll holder  
Porte-papier couvert  
Papierrollenhalter mit Deckel  
Portarrollos con tapa  
Держатель туалетной бумаги с крышкой

Articolo	Note	CROMO	BR	O
RG1113		170,00	189,00	226,00

RG1115

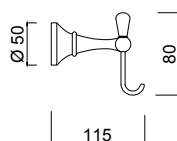

**Appendiabito.**

Clothes hanger.  
Patère.  
Haken.  
Colgador.  
Крючок одинарный

Articolo	Note	CROMO	BR	O
RG1115		75,00	85,00	104,00

RG1116

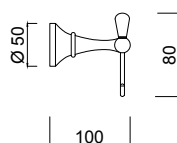

**Appendiabito doppio**

Double hook  
Porte-peignoir double  
Doppel-Kleiderhaken  
Percha doble  
Двойной крючок

Articolo	Note	CROMO	BR	O
RG1116		79,00	89,00	104,00

RG1128

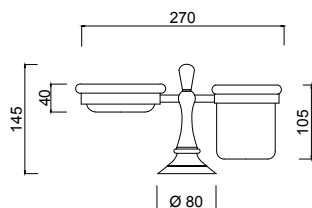

**Porta sapone/bicchiere da appoggio.**

Free-standing soap/cup-holder.  
Porte-savon/verre d'appui.  
Seifenschale mit Becherhalter.  
Jabonera/portavaso d'appoyo.  
Держатель со стаканом и мыльницей настольный.

Articolo	Note	CROMO	BR	O
RG1128		222,00	250,00	289,00

RG1129

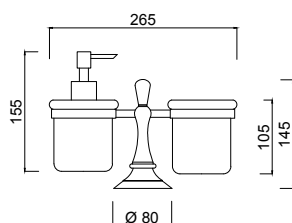

**Porta dispenser/bicchiere da appoggio.**

Free-standing dispenser/cup-holder.  
Doseur pour savon liquide et porte verre d'appui.  
Seifenspender/Becher.  
Dosifi cator de jabón líquido y portavaso d'appoyo.  
Держатель с диспенсером и стаканом настольны

Articolo	Note	CROMO	BR	O
RG1129		281,00	315,00	366,00

RG1130

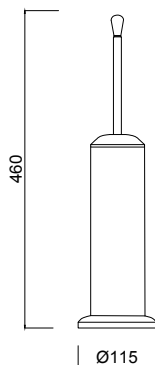

**Porta scopino da appoggio. ACCIAIO**

Free-standing brush-holder.  
Porte-balayette d'appui.  
Toilettebürstehalter.  
Portacepillo d'appoggio.  
Ерш напольный.

Articolo	Note	CROMO	BR	O	
RG1130		189,00	208,00	240,00	

RG1133

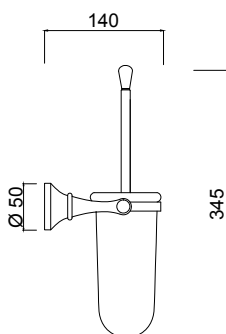

**Porta scopino da parete con coperchio.**

Wall brush-holder with lid.  
Porte-balayette au mur avec couvercle.  
Wandbürstengarnitur.  
Portacepillo de pared con tapa.  
Ерш подвесной с крышкой.

Articolo	Note	CROMO	BR	O	
RG1133		219,00	245,00	283,00	

RG1118

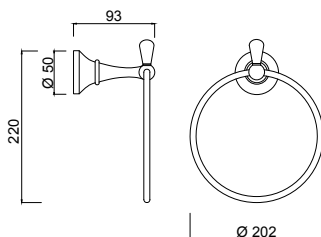

**Porta salviette ad anello.**

Ring shaped towel-rack.  
Porte-serviettes en anneau.  
Handtuchring.  
Toallero con forma de anillo.  
Полотенцедержатель.

Articolo	Note	CROMO	BR	O	
RG1118		82,00	93,00	106,00	

RG1121

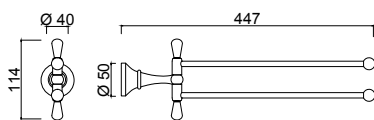

**Porta salviette snodato.**

Jointed towel-rack.  
Porte-serviettes orientable.  
Handtuchhalter.  
Toallero articulado.  
Полотенцедержатель.

Articolo	Note	CROMO	BR	O	
RG1121		192,00	217,00	252,00	

RG1148

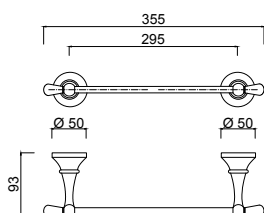

**Porta salviette bidet.**

Towel-rack.  
Porte-serviettes.  
Handtuchhalter.  
Toallero.  
Полотенцедержатель.

Articolo	Note	CROMO	BR	O	
RG1148		165,00	186,00	218,00	

RG1152

**Porta salviette.**  
*Towel-rack.*  
*Porte-serviettes.*  
*Handtuchhalter.*  
*Toallero.*  
*Полотенцедержатель.*

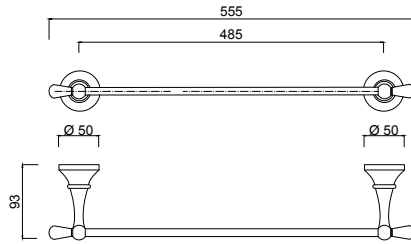

Articolo	Note	CROMO	BR	O	
<b>RG1152</b>		175,00	198,00	229,00	

RG1160

**Griglia porta spugna**  
*Basket soap holder*  
*Panier porte-savon*  
*Schwammkorb*  
*Jabonera*  
*Решетка для мыла*

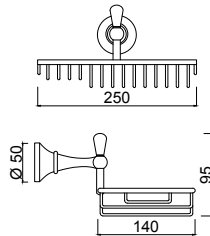

Articolo	Note	CROMO	BR	O	
<b>RG1160</b>		153,00	183,00	201,00	

Lilium





RG0903

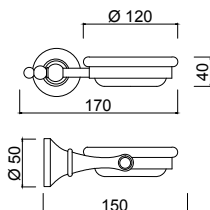

**Porta sapone da parete.**

Soap-holder.  
Porte-savon.  
Seifenschale.  
Jabonera.  
Мыльница.

Articolo	Note	CROMO	BR	O	
RG0903		128,00	148,00	167,00	

RG0936

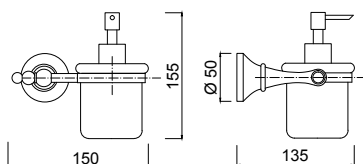

**Porta dispenser da parete.**

Liquid-soap dispenser.  
Doseur pour savon liquide.  
Seifenspenderhalter.  
Dosificator de jabon liquido.  
Диспенсер

Articolo	Note	CROMO	BR	O	
RG0936		188,00	210,00	243,00	

RG0906

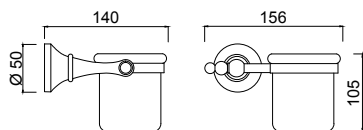

**Porta bicchiere da parete.**

Cup-holder.  
Porte-verre.  
Glashalter.  
Portavaso.  
Стакан.

Articolo	Note	CROMO	BR	O	
RG0906		128,00	148,00	167,00	

RG0909

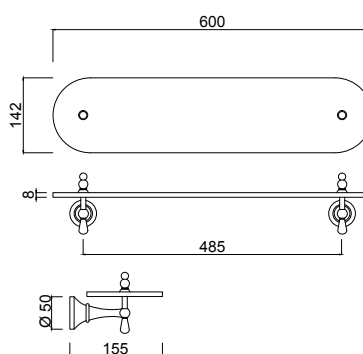

**Mensola in vetro.**

Glass-shelf.  
Etagère en verre.  
Ablage.  
Repisa en vidrio.  
Полка стеклянная.

Articolo	Note	CROMO	BR	O	
RG0909		310,00	350,00	407,00	

RG0912

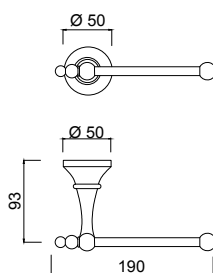

**Porta rotolo.**

Roll-holder.  
Porte-rouleau.  
Papierhalter.  
Portarollo.  
Бумагодержатель.

Articolo	Note	CROMO	BR	O	
RG0912		96,00	106,00	123,00	

**RG0913**

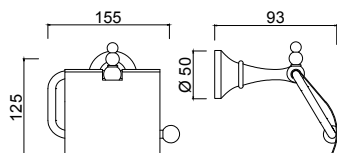

**Porta rotolo con coperchio**  
Covered toilet roll holder  
Porte-papier couvert  
Papierrollenhalter mit Deckel  
Portarrollos con tapa  
Держатель туалетной бумаги с крышкой

Articolo	Note	CROMO	BR	O	
<b>RG0913</b>		170,00	189,00	226,00	

**RG0915**

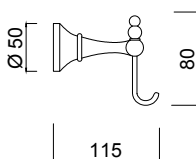

**Appendiabito.**  
Clothes hanger.  
Patère.  
Haken.  
Colgador.  
Крючок одинарный

Articolo	Note	CROMO	BR	O	
<b>RG0915</b>		75,00	85,00	104,00	

**RG0916**

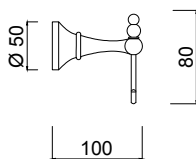

**Appendiabito doppio**  
Double hook  
Porte-peignoir double  
Doppel-Kleiderhaken  
Percha doble  
Двойной крючок

Articolo	Note	CROMO	BR	O	
<b>RG0916</b>		79,00	89,00	104,00	

**RG0928**

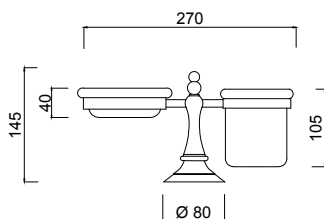

**Porta sapone/bicchieri da appoggio.**  
Free-standing soap/cup-holder.  
Porte-savon/verre d'appui.  
Seifenschale mit Becherhalter.  
Jabonera/portavaso d'appoyo.  
Держатель со стаканом и мыльницей настольный.

Articolo	Note	CROMO	BR	O	
<b>RG0928</b>		222,00	250,00	289,00	

**RG0929**

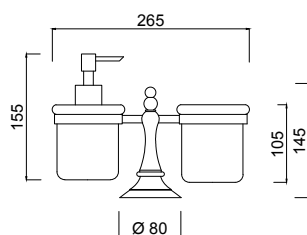

**Porta dispenser/bicchieri da appoggio.**  
Free-standing dispenser/cup-holder.  
Doseur pour savon liquide et porte verre d'appui.  
Seifenspenden/Becher.  
Dosifi cator de jabón liquido y portavaso d'appoyo.  
Держатель с диспенсером и стаканом настольны

Articolo	Note	CROMO	BR	O	
<b>RG0929</b>		281,00	315,00	366,00	

RG0930

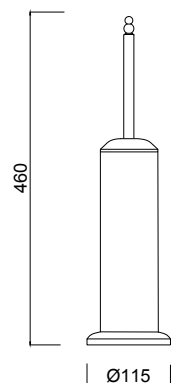

**Porta scopino da appoggio. ACCIAIO**

Free-standing brush-holder.  
Porte-balayette d'appui.  
Toilettebürstehalter.  
Portacepillo d'appoggio.  
Ерш напольный.

Articolo	Note	CROMO	BR	O	
RG0930		189,00	208,00	240,00	

RG0933

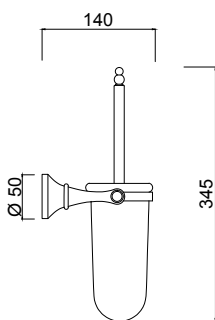

**Porta scopino da parete con coperchio.**

Wall brush-holder with lid.  
Porte-balayette au mur avec couvercle.  
Wandbürstengarnitur.  
Portacepillo de pared con tapa.  
Ерш подвесной с крышкой.

Articolo	Note	CROMO	BR	O	
RG0933		219,00	245,00	283,00	

RG0918

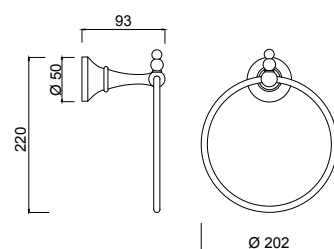

**Porta salviette ad anello.**

Ring shaped towel-rack.  
Porte-serviettes en anneau.  
Handtuchring.  
Toallero con forma de anillo.  
Полотенцедержатель.

Articolo	Note	CROMO	BR	O	
RG0918		82,00	93,00	106,00	

RG0921

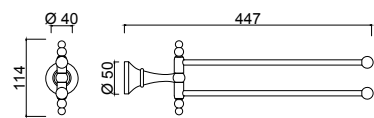

**Porta salviette snodato.**

Jointed towel-rack.  
Porte-serviettes orientable.  
Handtuchhalter.  
Toallero articulado.  
Полотенцедержатель.

Articolo	Note	CROMO	BR	O	
RG0921		192,00	217,00	252,00	

RG0948

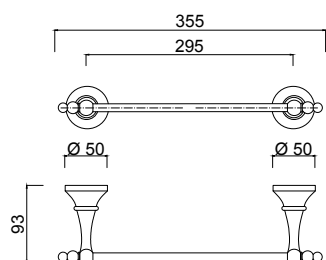

**Porta salviette bidet.**

Towel-rack.  
Porte-serviettes.  
Handtuchhalter.  
Toallero.  
Полотенцедержатель.

Articolo	Note	CROMO	BR	O	
RG0948		165,00	186,00	218,00	



RG0952

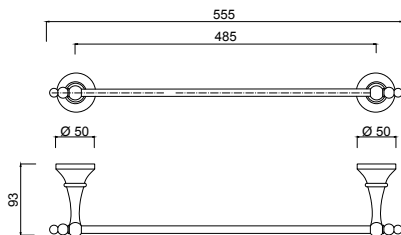

**Porta salviette.**  
*Towel-rack.*  
*Porte-serviettes.*  
*Handtuchhalter.*  
*Toallero.*  
*Полотенцедержатель.*

Articolo	Note	CROMO	BR	O	
<b>RG0952</b>		175,00	198,00	229,00	

RG0960

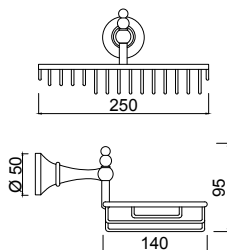

**Griglia porta spugna**  
*Basket soap holder*  
*Panier porte-savon*  
*Schwammkorb*  
*Jabonera*  
*Решетка для мыла*

Articolo	Note	CROMO	BR	O	
<b>RG0960</b>		153,00	183,00	201,00	

A photograph of a bathroom sink and mirror. The sink is white with a gold faucet and is mounted on a white vanity. Above the sink is a large, ornate white mirror with a decorative frame. The mirror reflects a window with white frames. The word "Specchi" is overlaid on the image in a large, dark, sans-serif font.

# Specchi

**SP 0003**

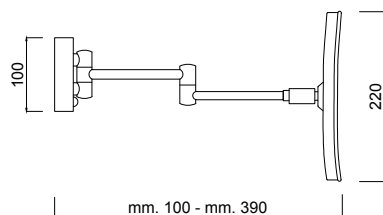

**Specchio ingranditore 2X da parete, braccio doppio snodo, illuminazione LED, interruttore a pulsante**

*Wall-mounted magnifying mirror 2x, double swiveling joint, LED Light, on/off switch*

*Настенное косметическое зеркало, с увеличением 2x, двойной поворотный шарнир, светодиодная подсветка, включатель*

Articolo	Note	CROMO	BO-NO-NKO	BR	O
<b>SP0003</b>		811,00	1.032,00	1.145,00	1.145,00

**SP 0006**

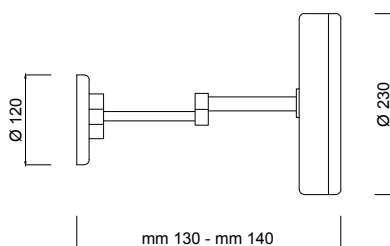

**Specchio ingranditore 2X da parete, braccio doppio snodo, illuminazione LED, interruttore a pulsante**

*Wall-mounted magnifying mirror 2x, double swiveling joint, LED Light, on/off switch*

*Настенное косметическое зеркало, с увеличением 2x, двойной поворотный шарнир, светодиодная подсветка, включатель*

Articolo	Note	CROMO	BO-NO-NKO	BR	O
<b>SP0006</b>		815,00	1.037,00	1.150,00	1.150,00

**SP 0012**

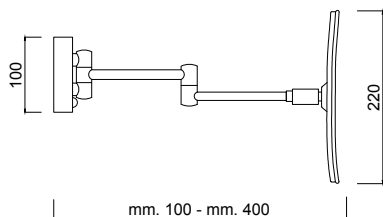

**Specchio ingranditore 2x da parete quadro. Braccio doppio e 2 snodi.**

*Wall-mounted magnifying mirror 2x. Double arm*

*Настенное косметическое зеркало, с увеличением 2x. Двойной кронштейн*

Articolo	Note	CROMO	BO-NO-NKO	BR	O
<b>SP0012</b>		447,00	569,00	604,00	604,00

**SP 0015**

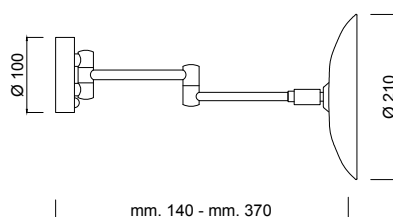

**Specchio ingranditore 2x da parete**

*Wall-mounted magnifying mirror 2x.*

*Настенное косметическое зеркало, с увеличением 2x*

Articolo	Note	CROMO	BO-NO-NKO	BR	O
<b>SP0015</b>		318,00	404,00	457,00	457,00

**SP 0009**

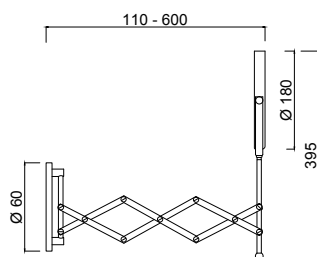

**Specchio doppia faccia piano e specchio ingranditore 2X da parete estensibile.**

*Double-face wall-mounted magnifier mirror 2x, extendible.*

*Двустороннее настенное косметическое зеркало, с увеличением 2x, раздвижное*

Articolo	Note	CROMO	BO-NO-NKO	BR	O
<b>SP0009</b>		475,00	•	593,00	686,00





5103L

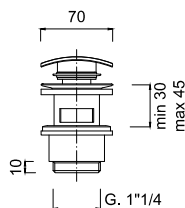

**Scarico per lavabo Up&Down 1"1/4 quadro**

Basin drain 1"1/4 Up&Down.  
Vidage lavabo Up&Down 1"1/4.  
Ablaufgarnitur Up&Down 1"1/4.  
Desague automatico Up&Down 1"1/4.  
Слив для умывальника Up&Down 1"1/4.

Articolo	Note	CROMO	BO-NO-BKO	BR	BEO-O
5103L		55,00	77,00	77,00	99,00

5102L

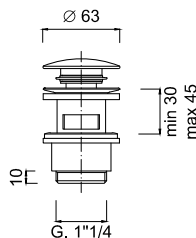

**Scarico per lavabo Up&Down 1"1/4.**

Basin drain 1"1/4 Up&Down.  
Vidage lavabo Up&Down 1"1/4.  
Ablaufgarnitur Up&Down 1"1/4.  
Desague automatico Up&Down 1"1/4.  
Слив для умывальника Up&Down 1"1/4.

Articolo	Note	CROMO	BO-NO-NKO	BR	BEO-O
5102L		45,00	63,00	63,00	81,00

5112

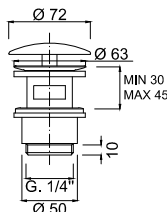

**Scarico per lavabo 1"1/4, scarico libero**

Basin drain 1"1/4, free flow.  
Vidage lavabo 1"1/4, toujours ouvert.  
Ablaufgarnitur 1"1/4, immer geöffnet.  
Desague automatico 1"1/4, descarga libre.  
Заглушка для раковины с соединением 1"1/4, свободный слив

Articolo	Note	CROMO	BO-NO-NKO	BR	O
5112		45,00	63,00	63,00	81,00

5105L

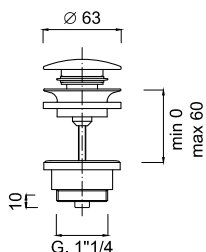

**Scarico per lavabo Up&Down 1"1/4.**

Basin drain 1"1/4 Up&Down.  
Vidage lavabo Up&Down 1"1/4.  
Ablaufgarnitur Up&Down 1"1/4.  
Desague automatico Up&Down 1"1/4.  
Слив для умывальника Up&Down 1"1/4.

Articolo	Note	CROMO	BO-NO-NKO	BR	BEO-O
5105L		45,00	63,00	63,00	81,00

5115

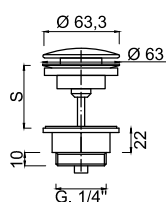

**Scarico per lavabo 1"1/4, scarico libero**

Basin drain 1"1/4, free flow.  
Vidage lavabo 1"1/4, toujours ouvert.  
Ablaufgarnitur 1"1/4, immer geöffnet.  
Desague automatico 1"1/4, descarga libre.  
Заглушка для раковины с соединением 1"1/4, свободный слив

Articolo	Note	CROMO	BO-NO-NKO	BR	O
5115		45,00	63,00	63,00	81,00

5003

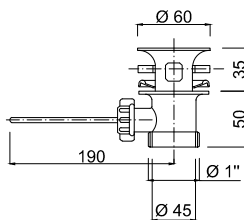

**Scarico lusso 1".**  
Luxury 1" pop-up waste.  
Vidage automatique 1" lux.  
Automatischer Ablauf 1" lux.  
Desagüe lujo 1".  
Слив люкс 1"

Articolo	Note	CROMO	BO-NO-NKO	AR-BR	O
5003		19,00	32,00	38,00	59,00

5004

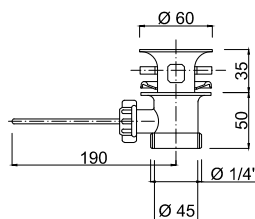

**Scarico lusso 1"1/4.**  
Luxury 1"1/4 pop-up waste.  
Vidage automatique 1"1/4 lux.  
Automatischer Ablauf 1"1/4 lux.  
Desagüe lujo 1"1/4.  
Слив люкс 1"1/4.

Articolo	Note	CROMO	BO-NO-NKO	AR-BR	O
5004		19,00	32,00	38,00	59,00

5005



**Astina per scarico.**  
Rod with ball.  
Tige avec sphère pour vidage automatique.  
Stange für automatischen Ablauf mit Kugel.  
Varilla para desagüe.  
Штанга для слива.

Articolo	Note	CROMO	BO-NO-NKO	BR	O
5005		2,20	•	4,00	•

5005L



**Astina per scarico L mm 300.**  
Rod with ball mm 300.  
Tige avec sphère pour vidage automatique mm 300.  
Stange für automatischen Ablauf mit Kugel mm 300.  
Varilla para desagüe mm 300.

Articolo	Note	CROMO	BO-NO-NKO	BR	O
5005L		2,20	•	4,00	•

5006



**Tappo per scarico 1" Ø 37.**  
Plug for drain 1" Ø 37.  
Bouchon pour vidage 1" Ø 37.  
Verschluß für Ablaufgarnitur von 1" Ø 37.  
tapón para desagüe 1" Ø 37.  
Затычка для слива 1" Ø 37.

Articolo	Note	CROMO	BO-NO-NKO	BR	O
5006		7,00	9,50	13,00	14,50

5007



**Tappo per scarico 1"1/4 Ø 40.**  
 Plug for drain 1"1/4 Ø 40.  
 Bouchon pour videge 1"1/4 Ø 40.  
 Verschluss für Ablaufgarnitur von 1"1/4 Ø 40.  
 tarón para desagüe 1"1/4 Ø 40.  
 Затычка для слива 1"1/4 Ø 40.

Articolo	Note	CROMO	BO-NO-NKO	BR	O
5007		7,00	9,50	13,00	14,50

5109PL

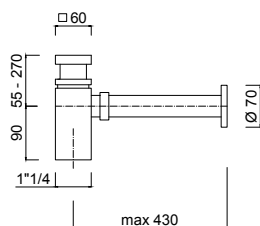

**Sifone per lavabo 1"1/4 quadro.**  
 Trap for basin 1"1/4.  
 Siphon lavabo 1"1/4.  
 Geruchsverschluss 1"1/4.  
 Sifón para lavabo 1"1/4.  
 Сифон для умывальника 1"1/4 квадратный.

Articolo	Note	CROMO	BO-NO-NKO	BR	BEO-O
5109PL		95,00	140,00	•	171,00

5109L

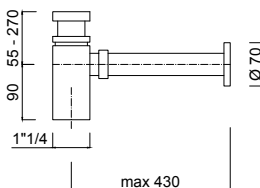

**Sifone per Lavabo 1"1/4.**  
 Trap for basin 1"1/4.  
 Siphon lavabo 1"1/4.  
 Geruchsverschluss 1"1/4.  
 Sifón para lavabo 1"1/4.  
 Сифон для умывальника 1"1/4.

Articolo	Note	CROMO	BO-NO-NKO	BR	BEO-O
5109L		90,00	135,00	•	162,00

5009

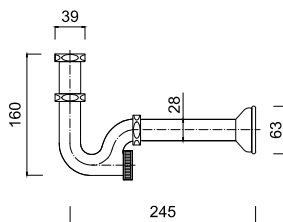

**Sifone per Lavabo 1"1/4.**  
 Trap for basin 1"1/4.  
 Siphon lavabo 1"1/4.  
 Messing Rohrsiphon 1"1/4 für Waschtisch  
 Sifón para lavabo 1"1/4.  
 Сифон для раковины 1"1/4

Articolo	Note	CROMO	BO-NO-NKO	AR-BR	O
5009		40,00	•	75,00	116,00

5009B

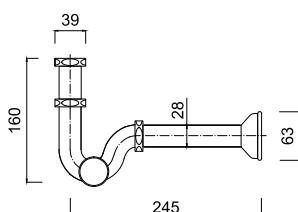

**Sifone per bidet 1"1/4.**  
 Brass basin trap 1"1/4.  
 Siphon bidet laiton 1"1/4.  
 Messing Rohrsiphon 1"1/4 für Bidet  
 Sifón bidet en laiton 1"1/4.  
 Сифон для умывальника из латуни 1"1/4.

Articolo	Note	CROMO	BO-NO-NKO	AR-BR	O
5009B		40,00	•	75,00	116,00



5011

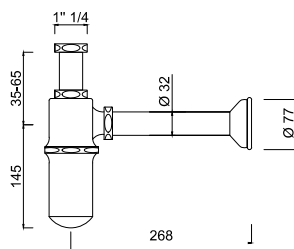
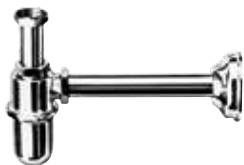

**Sifone 1" 1/4 a bottiglia.**  
*Bottle trap for basin 1" 1/4.*  
*Siphon bouteille pour lavabo 1"1/4.*  
*Tassensifon 1" 1/4 für Waschtisch.*  
*Sifón botella para lavabo 1"1/4.*  
*Сифон бутылка 1" 1/4.*

Articolo	Note	CROMO	BO-NO-NKO	AR-BR	O
5009B		40,00	•	75,00	116,00

3264PL

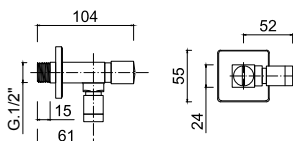

**Rubinetto sottolavabo con filterstop.**  
*Under-sink valve with filterstop.*  
*Coude sous lavabo avec filterstop.*  
*Eckventile mit Filter.*  
*Llave de paso para lavabo con filterstop.*  
*Смеситель под раковину с filterstop.*

Articolo	Note	CROMO	BO-NO-NKO	BR	BEO
3264PL		79,00	119,00	•	143,00

3264L

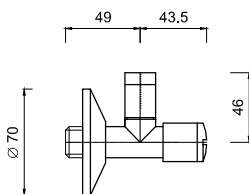

**Rubinetto sottolavabo con filterstop.**  
*Under-sink valve with filterstop.*  
*Coude sous lavabo avec filterstop.*  
*Eckventile mit Filter.*  
*Llave de paso para lavabo con filterstop.*  
*Смеситель под раковину с filterstop.*

Articolo	Note	CROMO	BO-NO-NKO	BR	BEO
3264L		48,00	70,00	•	87,00

3063

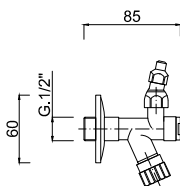

**Rubinetto con filtro con snodo.**  
*Tap with filter with articulated joint.*  
*Robinet d'arret avec filtre et coude*  
*Eckventil mit Filter*  
*Llave de regulaciòn con filtro*  
*Смеситель с фильтром и шарниром*

Articolo	Note	CROMO	BO-NO-NKO	BR	O
3063		21,50	•	48,00	71,50

3064

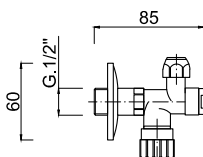

**Rubinetto con filtro.**  
*Tap with filter.*  
*Robinet d'arret avec filter.*  
*Eckventil mit Filter.*  
*Grifo con filtro.*  
*Смеситель с фильтром.*

Articolo	Note	CROMO	BO-NO-NKO	BR	O
3064		17.90	•	•	•

3262

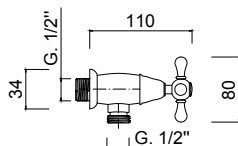

**Rubinetto sottolavabo.**  
Angle valve.  
Robinet d'arrêt sous lavabo.  
Eckventil.  
Llave de paso.  
Вентиль под раковину

Articolo	Note	CROMO	BO-NO-NKO	BR	O
3062		52,00	•	70,00	90,00

3070



**Tappo copriforo.**  
Hole cover.  
Cache-trou  
Lochdeckelverschluss  
Tapón cobreagujero.  
Затычка для отверстия

Articolo	Note	CROMO	BO-NO-NKO	BR	O
3070		7,00	9,00	10,00	13,00

0092X2

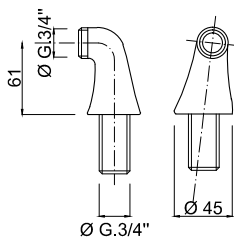

**Coppia colonnetta bordo vasca mm.60**  
Couple of short vertical connection for bathtub  
Couple jonctions verticales courts pour mélangeur bain  
Paar lang bindung für badewannengruppe  
Par conexiones verticales para bañera h. 60 mm.  
Пара длинных вертикальных креплений для смесителей для ванн 60 мм

Articolo	Note	CROMO	BO-NO-NKO	BR	O
0092X2		55,00	•	80,00	99,00

0092AX2

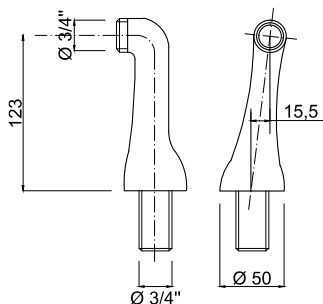

**Coppia colonnetta bordo vasca mm.125**  
Couple of long vertical connection for bathtub  
Couple jonctions verticales longs pour mélangeur bain  
Paar kurze bindung für badewannengruppe  
Par conexiones verticales para bañera h. 125 mm.  
Пара длинных вертикальных креплений для смесителей для ванн 125 мм

Articolo	Note	CROMO	BO-NO-NKO	BR	O
0092AX2		85,00	•	122,00	151,00

5167

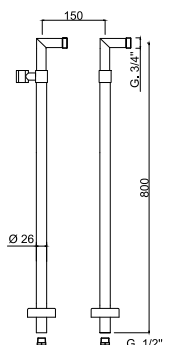

**Coppia piantoni a pavimento per gruppi vasca.**  
Pair floor external set for bathtub set.  
Couple jonctions verticales pour mélangeur bain  
Paarbindung für äußere Badewannengruppe  
Copia columna en suelo para grupo bañera.  
Пара напольных стоек для смесителя для ванны

Articolo	Note	CROMO	BO-NO-NKO	BR	O
5167		488,00	•	636,00	655,00

5168

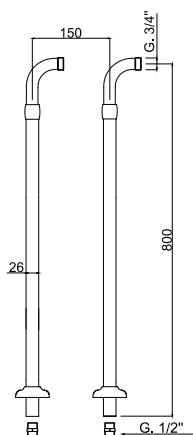

**Coppia piantoni a pavimento per gruppi vasca.**  
*Pair floor external set for bathtub set.*  
*Couple jonctions verticales pour mélangeur bain*  
*Paarbindung für äußere Badewannengruppe*  
*Copia columna en suelo para grupo bañera.*  
*Пара напольных стоек для смесителя для ванны*

Articolo	Note	CROMO	BO-NO-NKO	BR	O
5168		513,00	•	657,00	677,00

5164

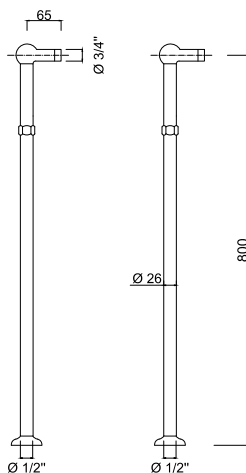

**Coppia piantoni a pavimento per gruppi vasca.**  
*Pair floor external set for bathtub set.*  
*Couple jonctions verticales pour mélangeur bain*  
*Paarbindung für äußere Badewannengruppe*  
*Copia columna en suelo para grupo bañera.*  
*Пара напольных стоек для смесителя для ванны*

Articolo	Note	CROMO	BO-NO-NKO	BR	O
5164		425,00	•	510,00	610,00

5165

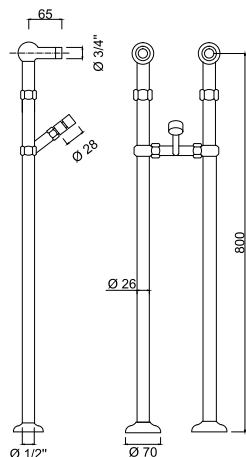

**Coppia piantoni a pavimento per gruppi vasca e attacco colonna vasca**  
*Pair floor external set for bathtub set.*  
*Couple jonctions verticales pour mélangeur bain*  
*Paarbindung für äußere Badewannengruppe*  
*Copia columna en suelo para grupo bañera.*  
*Пара напольных стоек для смесителя для ванны*

Articolo	Note	CROMO	BO-NO-NKO	BR	O
5165		505,00	•	598,00	695,00

5070

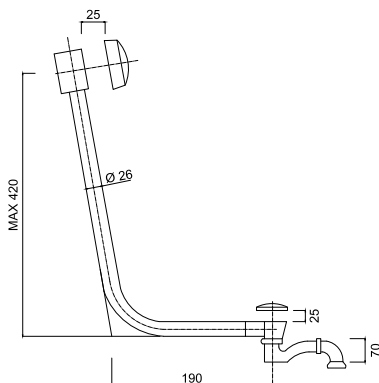

**Colonna vasca esterna a vista con tappo e catenella.**  
*External column for bathtub, with chain and plug.*  
*Colonne pour le baignoire extérieure à vue avec la bonde et la chaînette.*  
*Automatischer Säulenablauf für Badewannen, mit Stecker und Kette.*  
*Columna externa bañera, con tapon y cadena.*  
*Стойка для ванны с затычкой и цепочкой.*

Articolo	Note	CROMO	BO-NO-NKO	BR	O
5070		195,00	•	260,00	275,00

5014

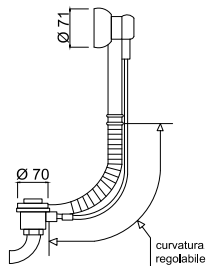

**Colonna vasca.**

Automatic pop-up waste for bathtub  
Vidage automatique à colonne pour baignoire avec alimentation  
Automatischer Säulenablauf für Badewannen  
Columna bañera.  
Стойка для ванны

Articolo	Note	CROMO	BO-NO-NKO	BR	O
5014		102,00	•	135,00	150,00

5018



**Squadretta Ø 12 con rosone e niplex mm 150x250.**

Square Ø 12 with rosette and nipple mm 150x250.  
équerre pour rondelle Ø 12 mm 150x250.  
Befestigungswinkel.  
Escuadrita Ø 12 para placa arandela e niplex mm 150x250.  
Крепеж Ø 12 с розеткой и соединителем мм 150x250.

Articolo	Note	CROMO	BO-NO-NKO	BR	O
5018		14,00	•	27,00	32,00

5019



**Rosone.**

Rosette.  
Rondelle.  
Unterlagsscheibe.  
Placa arandela.  
Розетка.

Articolo	Note	CROMO	BO-NO-NKO	BR	O
5019		2,00	•	6,00	9,00

0128



**Tubetto Ø 10 cm 35 con cartella e calotta.**

Ø 10 cm 35 connection pipe with casing and cap.  
Tuyans Ø 10 cm 35 avec bordure.  
Gebogene Schläuche Ø 10 cm 35 mit Rand.  
Tubito Ø 10 cm 35 con revestimiento y casquete.  
Трубка Ø 10 см 35 с креплением и колпаком.

Articolo	Note	CROMO	BO-NO-NKO	BR	O
0128		7,20	•	13,00	18,00

5052



**Canotto WC Ø 32 mm 250 con rosone.**

Ø 32 mm 250 tube with flange for WC  
Tuyan Ø 32 mm 250 avec rosace pour WC  
Schlauch Ø 32 mm 250 mit Rosette für WC  
Tubo descarga WC Ø 32 mm 250 con placa arandela  
Трубка WC Ø 32 мм 250 с розеткой

Altre misure disponibili su richiesta.  
Other sizes available on request.  
Другие размеры доступны по запросу.

Articolo	Note	CROMO	BO-NO-NKO	BR	O
5052		10,00	•	25,00	35,00

5090



**Meccanismo di scarico per cassetta alta con pull a catenella**  
*Mechanism for high level cistern with chain*  
*Mécanisme pour chasse d'eau haute, avec chaîne*  
*Mechanismus für hochhängenden Spülkasten, mit Kette*  
*Mecanismo para cisterna alta con cadena*  
*Сливной механизм для бабка высокой установки с цепочкой*

Articolo	Note	CROMO	BO-NO-NKO	BR	O
5090		193,00	•	269,00	299,00

5091



**Tubo in 3 pezzi con fissaggi, per cassetta alta**  
*Connection pipe (made in 3 pcs) for high level cistern*  
*Tuyaux de connexion en laiton pour chasse d'eau haute*  
*Spülrohr (3 tlg.) für hochhängende Spülkästen*  
*Tubo (3 partes) con fijaciones, para cisterna alta.*  
*труба составная из 3 частей с креплениями для высокого бабка*

Articolo	Note	CROMO	BO-NO-NKO	BR	O
5091		211,00	•	405,00	441,00

5024

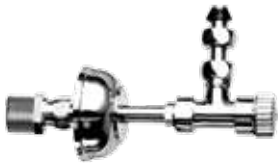

**Rubinetto per cassetta.**  
*Tap for WC box.*  
*Robinet pour caissette de WC.*  
*Armatur für WC-Kasten.*  
*Grifo para cajita.*  
*Кран для бабка унитаза.*

Articolo	Note	CROMO	BO-NO-NKO	BR	O
5024		32,00	•	63,00	76,00

5033



**Passo rapido incasso 3/4".**  
*3/4" built-in quick pitch.*  
*Pas rapide pour WC type encaissé 3/4.*  
*Unterputz-Schnellbanghohe 3/4.*  
*Paso rápido para empotrar 3/4".*  
*Встроенный кран в виде рычага для слива 3/4" для WC.*

Articolo	Note	CROMO	BR	O	
5033		105,00	120,00	148,00	

5B40



**Rubinetto incasso cappuccio chiuso 1/2".**  
*1/2" close cap built-in tap.*  
*Robinet à encaissement come fermé 1/2".*  
*Einbauhahn mit 1/2" verschloßenem Käppchen.*  
*Grifo para empotrar con pequeño capucho cerrado 1/2".*  
*Встраиваемый смеситель с закрытым колпаком 1/2".*

Articolo	Note	CROMO	BR	O	
5B40		37,00	56,00	61,00	

0535



**Rubinetto artistico da esterno.**

*Wrought tap for exterior.*

*Robinet artistique pour l'extérieur.*

*Artistischer Aussenhahn.*

*Grifo artistico para externo.*

*Наружный смеситель в оригинальном исполнении.*

Articolo	Note				
0535		55,00			

5047



**Tappo copripiletta per lavabo 1".**

*Plug for drain 1".*

*Bouchon pour vidage 1".*

*Verschluß für Ablaufgarnitur von 1".*

*Tapón cubre cono de descarga para lavabo 1".*

*Затычка для слива для умывальника 1".*

Articolo	Note	CROMO	BO-NO-NKO	BR	O
5047		13,00	21,00	24,00	27,00

5048



**Tappo copripiletta per lavabo 1"1/4.**

*Plug for drain 1"1/4*

*Bouchon pour vidage 1"1/4*

*Verschluß für Ablaufgarnitur von 1"1/4*

*Tapón cubre cono de descarga para lavabo 1"1/4*

*Затычка для слива для умывальника 1"1/4*

Articolo	Note	CROMO	BO-NO-NKO	BR	O
5048		13,00	21,00	24,00	27,00

5049



**Piastra coprisifone Ø 150 .**

*Siphon cover plate Ø 150.*

*Plaque cache-siphon au sol.*

*Abdeckplatte für Siphon auf Boden.*

*Plancha cubresifon Ø 150.*

*Пластина закрывающая сифон Ø 150 .*

Articolo	Note	CROMO	BR	O	
5049		15,00	30,00	45,00	

3083



**Curvetta sottolavabo monocomandi.**

*Single-lever mixers small sub- washbasin elbow.*

*Petite courbe sous l'évier mix.*

*Winkelverbinder für Waschtisch.*

*Codillo bajo el lavabo monomandos.*

*Отвод под мойку.*

Articolo	Note	CROMO	BR	O	
3083		9,00	13,00	18,00	

5055A



**Piletta Gattinara 1"1/4 con tappo e catenella, per cucina.**  
Gattinara 1"1/4 drain with cover cap and chain, for sink.  
Bonde Gattinara 1"1/4 avec bouchon chainette.  
Gattinara Ventil 1" 1/4 für Spültisch mit Stopfen und Kette.  
Cono Gattinara 1"1/4 con tapón y cadena, para cocina.  
Слив Gattinara 1"1/4 с затычкой и цепочкой, для кухни.

Articolo	Note	CROMO	BR	O
5055A		32,00	42,00	50,00

3047

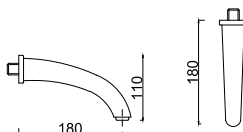

**Bocca incasso monocomandi fil. 1/2" F.**  
Single-lever mixers built-in spout fil. 1/2" F.  
Bouche à encaissement sans déviateur mix 1/2" F.  
Unterputzmündung mit Umleiter 1/2" M.  
Boca para empotrar monomandos fil. 1/2" F.  
Встраиваемый носик для однорычажного смесителя 1/2" F.

Articolo	Note	CROMO	BR	O
3047		94,00	115,00	135,00

3222-25

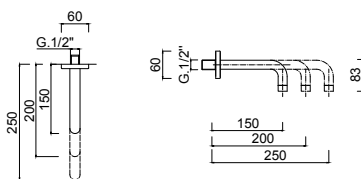

**Bocca Ø 24 mm 250 con rosone fil. 1/2" M.**  
Ø 24 mm 250 spout with rosette fil. 1/2" M.  
Bouche Ø 24 mm 250 avec rondelle 1/2" M.  
Auslauf Ø 24 mm 250 mit Scheibe 1/2" M.  
Boca Ø 24 mm 250 con placa a rendela fil. 1/2" M.  
Излив Ø 24 мм 250 с розеткой fil. 1/2" M.

Articolo	Note	CROMO	BO-NO	BR
3222-25	mm 250	61,00	82,00	105,00
3222-20	mm 200	61,00	82,00	105,00
3222-15	mm 150	61,00	82,00	105,00

5080-20

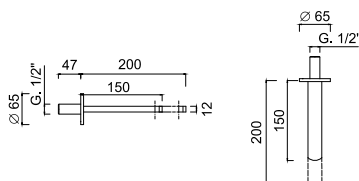

**Bocca mm 200, con rosone.**  
Spout mm 200, with rosette.  
Bec mural mm 200, avec rosace.  
Wandauslauf mm 200, mit Rosette.  
Caño mural mm 200, con florón.  
Излив длина 200 мм с розеткой

Articolo	Note	CROMO	BO-NO-NKO
5080-20	mm 200	154,00	202,00
5080-15	mm 150	154,00	202,00

5083-20

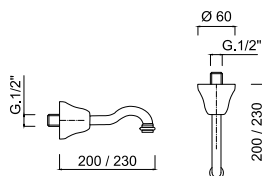

**Bocca con rosone.**  
Spout with rosette.  
Bec mural avec rosace.  
Wandauslauf mit Rosette.  
Caño mural con florón.  
Излив с розеткой

Articolo	Note	CROMO	BR	O
5083-20	mm 200	50,00	83,00	110,00
5083-15	mm 150	50,00	83,00	110,00

**9856/B1**

**Bocca cascata a muro per vasca.**  
*Wall waterfall spout for bathtub mixer.*  
*Bec mural à cascade pour mitigeur bain.*  
*Wasserfall-Auslauf fuer Badewanne.*  
*Caño mural en cascada para bañera.*  
*Настенный излив каскадом для ванной*

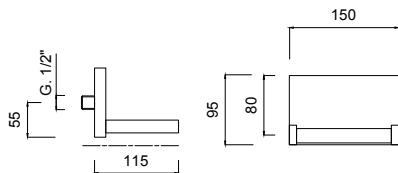

Articolo	Note	CROMO	BO-NO-BKO	BR	O
9856/B1		690,00	•	•	•

**9856/B5**

**Bocca cascata a muro per vasca.**  
*Wall waterfall spout for bathtub mixer.*  
*Bec mural à cascade pour mitigeur bain.*  
*Wasserfall-Auslauf fuer Badewanne.*  
*Caño mural en cascada para bañera.*  
*Настенный излив каскадом для ванной*

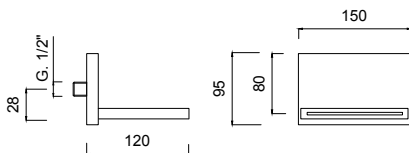

Articolo	Note	CROMO	BO-NO-BKO	BR	O
9856/B5		690,00	•	•	•

**9855/B1**

**Bocca cascata bordo vasca.**  
*Wall waterfall spout for bath deck mixer.*  
*Bec mural à cascade pour bord baignoire.*  
*Wanneneinlauf für Wannenrandbatterie.*  
*Caño mural en cascada para borde bañera.*  
*Излив каскадом для установки на борту ванны.*

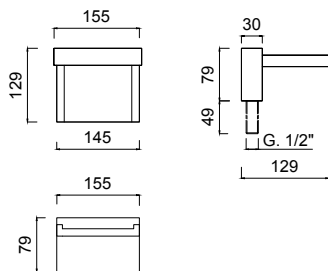

Articolo	Note	CROMO	BO-NO-BKO	BR	O
9855/B1		730,00	•	•	•

**9855/B5**

**Bocca cascata bordo vasca.**  
*Wall waterfall spout for bath deck mixer.*  
*Bec mural à cascade pour bord baignoire.*  
*Wanneneinlauf für Wannenrandbatterie.*  
*Caño mural en cascada para borde bañera.*  
*Излив каскадом для установки на борту ванны.*

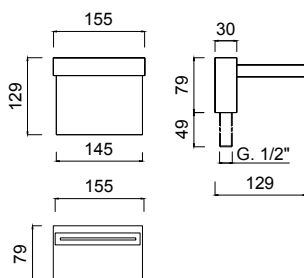

Articolo	Note	CROMO	BO-NO-BKO	BR	O
9855/B5		730,00	•	•	•



9857-14

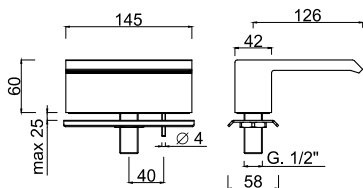

**Bocca cascata bordo vasca.**

Wall waterfall spout for bath deck mixer.  
Bec mural à cascade pour bord baignoire.  
Wanneneinlauf für Wannenrandbatterie.  
Caño mural en cascada para borde bañera.  
Излив каскадом для установки на борту ванны.

Articolo	Note	CROMO	BO-NO-BKO	BR	O
9857-14		440,00	•	•	•

9857-28

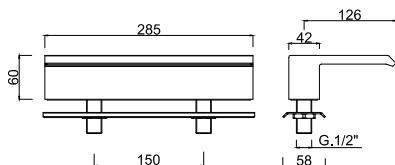

**Bocca cascata bordo vasca.**

Wall waterfall spout for bath deck mixer.  
Bec mural à cascade pour bord baignoire.  
Wanneneinlauf für Wannenrandbatterie.  
Caño mural en cascada para borde bañera.  
Излив каскадом для установки на борту ванны.

Articolo	Note	CROMO	BO-NO-BKO	BR	O
9857-28		690,00	•	•	•

5122

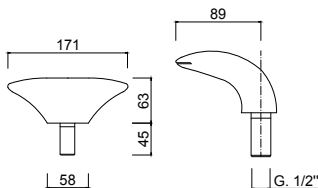

**Bocca a cascata per bordo vasca.**

Cascade spout for bath.  
Bec Cascade.  
Wanneneinlauf für Wannenrandbatterie.  
Caño llenado para bañera sobre repisa a cascada.  
Излив каскадом для установки на борту ванны.

Articolo	Note	CROMO	BO-NO-BKO	BR	O
5122		170,00	•	•	•

0058

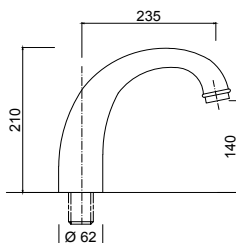

**Bocca bordo vasca.**

Boarder bath set spout.  
Bec bord baignoire.  
Wanneneinlauf für Wannenrandbatterie.  
Boca borde bañera.  
Излив для установки на борту ванны.

Articolo	Note	CROMO	CR	AR-BR	O
0058		225,00	247,00	270,00	295,00

5123

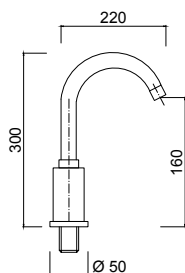

**Bocca bordo vasca.**  
*Boarder bath set spout.*  
*Bec bord baignoire.*  
*Wanneneinlauf für Wannenrandbatterie.*  
*Boca borde bañera.*  
*Излив для установки на борту ванны.*

Articolo	Note	CROMO	BO-NO-BKO	BR	O
5123		120,00	•	•	

5123L

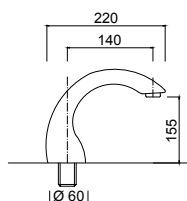

**Bocca bordo vasca.**  
*Boarder bath set spout.*  
*Bec bord baignoire.*  
*Wanneneinlauf für Wannenrandbatterie.*  
*Boca borde bañera.*  
*Излив для установки на борту ванны.*

Articolo	Note	CROMO	BO-NO-BKO	BR	O
5123L		280,00	•	•	390,00

0058DV

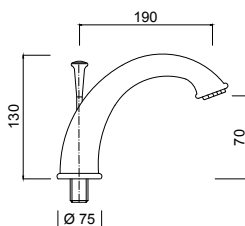

**Bocca bordo vasca.**  
*Boarder bath set spout.*  
*Bec bord baignoire.*  
*Wanneneinlauf für Wannenrandbatterie.*  
*Boca borde bañera.*  
*Излив для установки на борту ванны.*

Articolo	Note	CROMO	CR	AR-BR	O
0058DV		265,00	291,00	370,00	480,00

3079



**Prolunga doccia incasso monocomandi da mm. 280. Specificare per quale articolo.**  
*Single-lever mixers built-in shower extension hose from mm. 280. Specify for which item.*  
*Rallonge douche à encaissement pour mitigeurs mm. 280. Spécifier pour quel article.*  
*Verlängerung für Einhebelmischer Unteputzbatterie 280mm. Für welche Artikelnummer nennen.*  
*Alargador ducha para empotrar monomandos mm. 280. Especificar que referencia.*  
*Удлинитель для однорычажного смесителя встроенного душа 280 мм. Уточнить, для какого артикула.*

Articolo	Note	CROMO	BO-NO-NKO	BR	O
3079		60,00	78,00	84,00	96,00

3079B



**Prolunga doccia incasso con pulsante MIX. Specificare per quale articolo.**

*MIX built-in shower extension with button. Specify for which item.  
Rallonge pour monocommande à encaiss plus déviateur MIX.  
Spécifier pour quel article.  
Verlängerung für MIX Unterputzbatterie mit Druckknopf. Für welche Artikelnummer nennen.  
Alargador monomando ducha para empotrar con pulsador MIX.  
Especifiquen la referencia.  
Удлинитель для встроенного душа с кнопкой MIX. Уточнить, для какого артикула*

Articolo	Note	CROMO	BO-NO-NKO	BR	O
3079B		75,00	90,00	99,00	110,00

0095



**Prolunga per rubinetto incasso. Specificare per quale articolo.**

*Extension hose for built-in tap. Specify for which item.  
Rallonge pour robinet à encastrer. Indiquer pour quelle la référence.  
Verlängerung für Serie Unterputzhahn. Für welche Artikelnummer nennen.  
Alargador para grifo para empotrar. Especifici quen la referencia.  
Удлинитель для встроенного смесителя. Уточнить, для какого артикула.*

Articolo	Note	CROMO	BO-NO-NKO	BR	O
0095		9,00	•	21,00	31,00

0095L



**Prolunga per rubinetto incasso. Specificare per quale articolo.**

*Extension hose for built-in tap. Specify for which item.  
Rallonge pour robinet à encastrer. Indiquer pour quelle la référence.  
Verlängerung für Serie Unterputzhahn. Für welche Artikelnummer nennen.  
Alargador para grifo para empotrar. Especifici quen la referencia.  
Удлинитель для встроенного смесителя. Уточнить, для какого артикула.*

Articolo	Note	CROMO	BO-NO-BKO	BR	O
0095L		15,00	•	21,00	24,00

5200

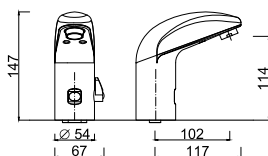

**Miscelatore elettronico per lavabo con alimentazione a batteria.**  
Wash-basin mixer operated by infrared sensor. Powered by battery.  
Mitigeur à détection infrarouge pour lavabo, alimentation à piles.  
Sensorarmatur mit Mischeinrichtung für Waschtisch mit 6V Batterie.  
Mezclador para lavabo con sensor a infrarrojos. Alimentación con batería.  
Смеситель для раковины, управляемый инфракрасным сенсором, работающим от батареи.

Articolo	Note	CROMO			
5200		571,00			

5202

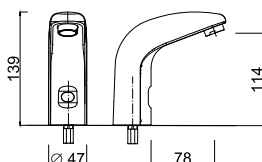

**Rubinetto elettronico per lavabo con alimentazione a batteria.**  
Wash-basin tap, operated by infrared sensor. Powered by battery.  
Robinet à détection infrarouge pour lavabo, alimentation à piles.  
Sensorarmatur für Waschtisch mit 6V Batterie.  
Grifo para lavabo con sensor a infrarrojos. Alimentación con batería.

Articolo	Note	CROMO			
5202		404,00			

5204

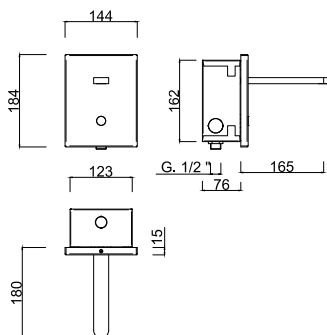

**Rubinetto elettronico da incasso con bocca di erogazione.**  
Built-in tap operated by infrared sensor with spout. Powered by battery.  
Robinet à détection infrarouge mural pour lavabo avec bec.  
Alimentation à piles.  
UP-Sensorarmatur für Waschtisch mit 6V Batterie.  
Grifo con sensor infrarrojos para lavabo con caño. Alimentación con batería.  
Встраиваемый кран, управляемый инфракрасным сенсором, работающим от батареи.

Articolo	Note	CROMO			
5204		924,00			

5206

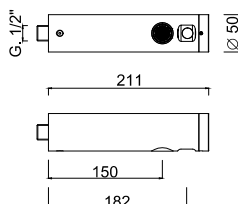

**Miscelatore per lavabo temporizzato con comando a pulsante.**  
Self-closing push button basin mixer.  
Mitigeur temporisé lavabo à poussoir. Temporisation 15sec.  
Einhand-Selbstschlußmischer für Waschtisch, 15 sec.  
Mezclador temporizado lavabo pared con pulsador, fij. encimera.  
Temporización 15sec.  
Самозакрывающийся нажимной смеситель для раковины

Articolo	Note	CROMO			
5206		730,00			

5208

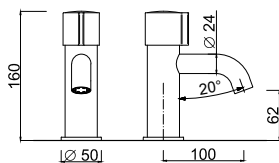

**Miscelatore per lavabo temporizzato con comando a pulsante.**  
Self-closing push button basin mixer.  
Mitigeur temporisé lavabo à poussoir. Temporisation 15sec.  
Einhand-Selbstschlußmischer für Waschtisch, 15 sec.  
Mezclador temporizado lavabo pared con pulsador, fij. encimera.  
Temporización 15sec.  
Самозакрывающийся нажимной смеситель для раковины

Articolo	Note	CROMO			
5208		268,00			

5210

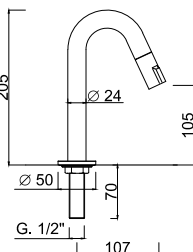

**Rubinetto a colonna per lavabo minimale con vitone ceramico assiale.**  
Minimalistic basin tap with ceramic axial cartridge.  
Robinet à colonne pour lavabo avec tête axiale à disques céramiques  
Waschtischarmatur mit axialem Keramikoberteil.  
Grifo a columna para lavabo minimal con montura cerámica axiale.  
Миниатюрный смеситель для раковины с осевым керамическим картриджем

Articolo	Note	CROMO			
5210		194,00			

5212

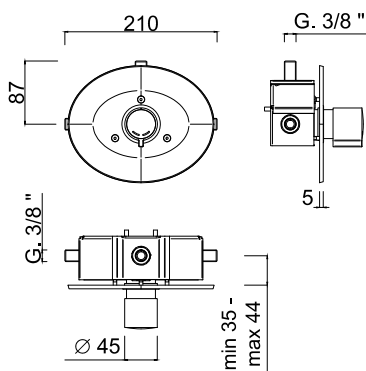

**Miscelatore per doccia con scatola da incasso e comando a pulsante. Temporizzato 15 sec.**  
Built-in wall mounted self-closing push button shower mixer with concealed box. Timing 15 sec.  
Mitigeur pour douche avec poussoir et boîte encastrée. Temporisation 15 sec.  
Einhand-Selbstschlußmischer für Dusche mit Einbauschachtel für Unterputzmontage 15 sec.  
Mezclador temporizado para ducha con pulsador y caja empotrada.  
Temporización 15 seg.  
Встраиваемый самозакрывающийся нажимной смеситель для душа настенного монтажа с встраиваемым боксом. Интервал работы 15 сек.

Articolo	Note	CROMO			
5212		324,00			





Moderno





### 9820Q

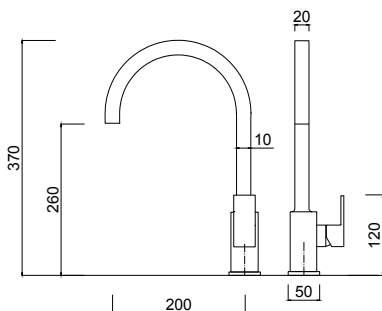

**Monocomando lavello cucina, bocca girevole (con flessibile)**  
Single-hole single-lever mixer for sink, swivel spout (with flexible).  
Mitigeur évier monotrou, bec mobile (avec flexible).  
Einloch- Einhebelmischer für Spülbecken, Rohrauslauf (mit flexiblen Anschlusschläuchen).  
Monomando monoagujero fregadero, caño giratorio (con flexible).  
Однорычажный смеситель на одно отверстие для мойки, поворотный излив (гибкая подводка).

Articolo	Note	CROMO	PV	C	BO-NO-NKO
9820Q	PB	368,00	•	•	496,00

### 9820P

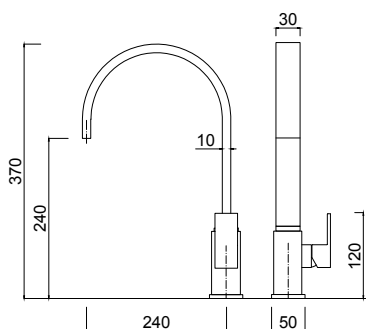
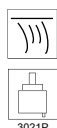

**Monocomando lavello cucina, bocca girevole (con flessibile)**  
Single-hole single-lever mixer for sink, swivel spout (with flexible).  
Mitigeur évier monotrou, bec mobile (avec flexible).  
Einloch- Einhebelmischer für Spülbecken, Rohrauslauf (mit flexiblen Anschlusschläuchen).  
Monomando monoagujero fregadero, caño giratorio (con flexible).  
Однорычажный смеситель на одно отверстие для мойки, поворотный излив (гибкая подводка).

Articolo	Note	CROMO	PV	C	BO-NO-NKO
9820P	PB	368,00	•	•	496,00

### MR0080

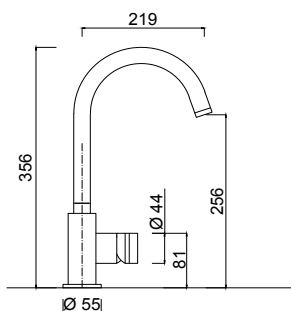

**Monocomando lavello cucina, bocca girevole (con flessibile)**  
Single-hole single-lever mixer for sink, swivel spout (with flexible).  
Mitigeur évier monotrou, bec mobile (avec flexible).  
Einloch- Einhebelmischer für Spülbecken, Rohrauslauf (mit flexiblen Anschlusschläuchen).  
Monomando monoagujero fregadero, caño giratorio (con flexible).  
Однорычажный смеситель на одно отверстие для мойки, поворотный излив (гибкая подводка).

Articolo	Note	CROMO	PV	C	BO-NO-NKO
MR0080	MYRing	266,00	293,00	319,00	380,00

### 6580

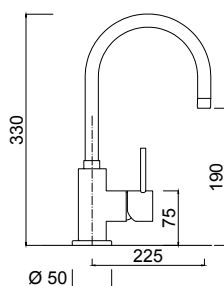

**Monocomando lavello cucina, bocca girevole (con flessibile)**  
Single-hole single-lever mixer for sink, swivel spout (with flexible).  
Mitigeur évier monotrou, bec mobile (avec flexible).  
Einloch- Einhebelmischer für Spülbecken, Rohrauslauf (mit flexiblen Anschlusschläuchen).  
Monomando monoagujero fregadero, caño giratorio (con flexible).  
Однорычажный смеситель на одно отверстие для мойки, поворотный излив (гибкая подводка).

Articolo	Note	CROMO	PV	C	BO-NO-NKO
6580	FU	215,00	•	•	290,00

### 6524

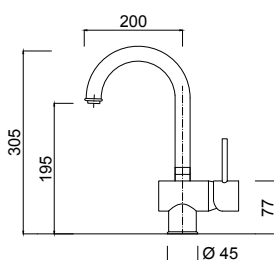

**Monocomando lavello cucina, bocca girevole (con flessibile)**  
Single-hole single-lever mixer for sink, swivel spout (with flexible).  
Mitigeur évier monotrou, bec mobile (avec flexible).  
Einloch- Einhebelmischer für Spülbecken, Rohrauslauf (mit flexiblen Anschlusschläuchen).  
Monomando monoagujero fregadero, caño giratorio (con flexible).  
Однорычажный смеситель на одно отверстие для мойки, поворотный излив (гибкая подводка).

Articolo	Note	CROMO	PV	C	BO-NO-NKO
6524	FU	165,00	•	•	223,00

6514

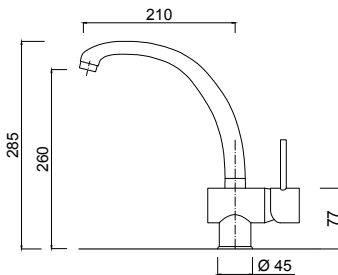

**Monocomando lavello cucina, bocca girevole (con flessibile)**  
Single-hole single-lever mixer for sink, swivel spout (with flexible).  
Mitigeur évier monotrou, bec mobile (avec flexible).  
Einloch- Einhebelmischer für Spülbecken, Rohrauslauf (mit flexiblen Anschlusschläuchen).  
Monomando monoagujero fregadero, caño giratorio (con flexible).  
Однорычажный смеситель на одно отверстие для мойки, поворотный излив (гибкая подводка).

Articolo	Note	CROMO	PV	C	BO-NO-NKO
6514	FU	145,00	•	•	195,00

6516

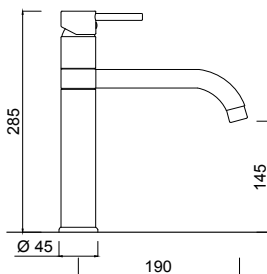

**Monocomando lavello cucina, bocca girevole (con flessibile)**  
Single-hole single-lever mixer for sink, swivel spout (with flexible).  
Mitigeur évier monotrou, bec mobile (avec flexible).  
Einloch- Einhebelmischer für Spülbecken, Rohrauslauf (mit flexiblen Anschlusschläuchen).  
Monomando monoagujero fregadero, caño giratorio (con flexible).  
Однорычажный смеситель на одно отверстие для мойки, поворотный излив (гибкая подводка).

Articolo	Note	CROMO	PV	C	BO-NO-NKO
6516	FU	203,00	•	•	305,00

6574

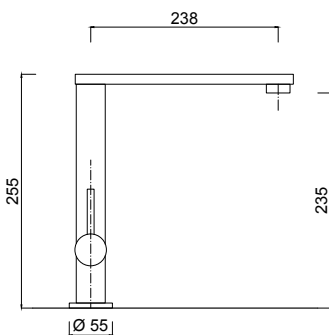

**Monocomando lavello cucina, bocca girevole (con flessibile)**  
Single-hole single-lever mixer for sink, swivel spout (with flexible).  
Mitigeur évier monotrou, bec mobile (avec flexible).  
Einloch- Einhebelmischer für Spülbecken, Rohrauslauf (mit flexiblen Anschlusschläuchen).  
Monomando monoagujero fregadero, caño giratorio (con flexible).  
Однорычажный смеситель на одно отверстие для мойки, поворотный излив (гибкая подводка).

Articolo	Note	CROMO	PV	C	BO-NO-NKO
6574	FUM	277,00	•	•	415,00

6573

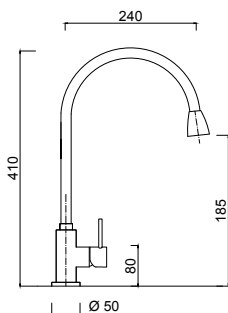

**Monocomando lavello monoforo con doccia estraibile a due getti**  
Single-hole single-lever mixer for sink double jet with extractable shower  
Mitigeur évier avec douchette 2-jets extractible  
Einhand-Spültischbatterie mit herausziehbarer Brause/Strahlart  
Monomando fregadero monoagujero ducha extraible  
Смеситель для кухонной раковины на одно отверстие с выдвижным душем на 2 струи

Articolo	Note	CROMO	PV	C	BO-NO-NKO
6573	FU	335,00	•	•	•

6572

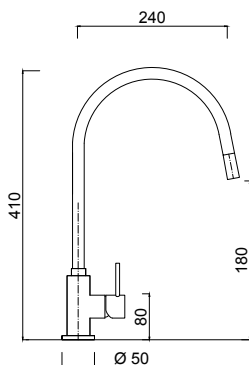
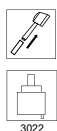

**Monocomando lavello monoforo con doccia estraibile**  
Single-hole single-lever mixer for sink with extractable shower  
Mitigeur évier avec douchette extractible  
Einhand-Spültischbatterie mit herausziehbarer Brause/Strahlart  
Monomando fregadero monoagujero ducha extraible  
Смеситель для кухонной раковины на одно отверстие с выдвижным душем

Articolo	Note	CROMO	PV	C	BO-NO-NKO
6572	FU	296,00	•	•	414,00

6576

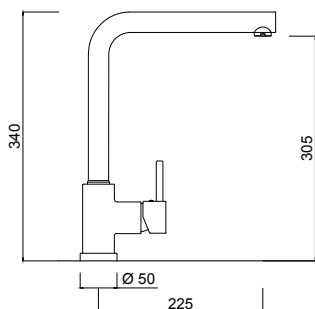
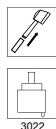

**Monocomando lavello monoforo con doccia estraibile**  
Single-hole single-lever mixer for sink with extractable shower  
Mitigeur évier avec douchette extractible  
Einhand-Spültischbatterie mit herausziehbarer Brause/Strahlart  
Monomando fregadero monoagujero ducha extraíble  
Смеситель для кухонной раковины на одно отверстие с выдвигаемым душем

Articolo	Note	CROMO	PV	C	BO-NO-NKO
6576	FU	255,00	•	•	•

6519

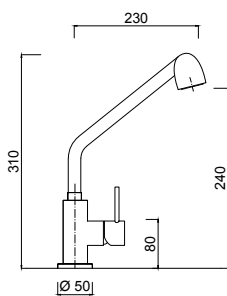

**Monocomando lavello monoforo con doccia estraibile a due getti**  
Single-hole single-lever mixer for sink double jet with extractable shower  
Mitigeur évier avec douchette 2-jets extractible  
Einhand-Spültischbatterie mit herausziehbarer Brause/Strahlart  
Monomando fregadero monoagujero ducha extraíble  
Смеситель для кухонной раковины на одно отверстие с выдвигаемым душем на 2 струи

Articolo	Note	CROMO	PV	C	BO-NO-NKO
6519	FU	215,00	•	•	•

6517

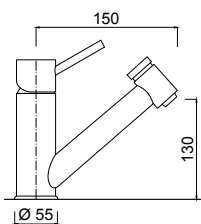

**Monocomando lavello monoforo con doccia estraibile a due getti**  
Single-hole single-lever mixer for sink double jet with extractable shower  
Mitigeur évier avec douchette 2-jets extractible  
Einhand-Spültischbatterie mit herausziehbarer Brause/Strahlart  
Monomando fregadero monoagujero ducha extraíble  
Смеситель для кухонной раковины на одно отверстие с выдвигаемым душем на 2 струи

Articolo	Note	CROMO	PV	C	BO-NO-NKO
6517	FU	188,00	•	•	•

6518

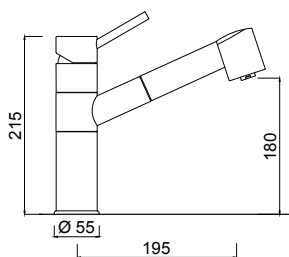

**Monocomando lavello monoforo con doccia estraibile a due getti**  
Single-hole single-lever mixer for sink double jet with extractable shower  
Mitigeur évier avec douchette 2-jets extractible  
Einhand-Spültischbatterie mit herausziehbarer Brause/Strahlart  
Monomando fregadero monoagujero ducha extraíble  
Смеситель для кухонной раковины на одно отверстие с выдвигаемым душем на 2 струи

Articolo	Note	CROMO	PV	C	BO-NO-NKO
6518	FU	158,00	•	•	•

6554

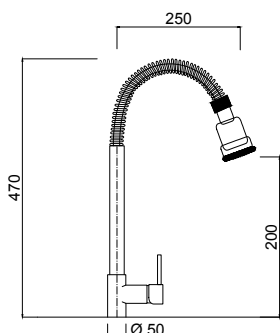
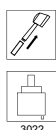

**Monoforo per cucine industriali con molla H. cm 40 e doccia estraibile.**  
Single-hole single lever mixer for industrial kitchen with H. cm 40 spring and extractable shower.  
Mitigeur évier monotrou pour cuisine industriel avec douchette extractible 40 cm h.  
Einhand-Spültischbatterie für industrielle Küche mit herausziehbarer Brause 40 cm h.  
Monomando fregadero monoagujero caño abatible y ducha extraíble.  
**RUSSO**

Articolo	Note	CROMO	PV	C	BO-NO-NKO
6554	FU	309,00	•	•	•

6550

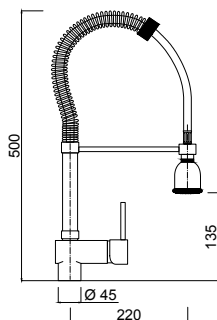
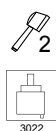

**Monoforo per cucine industriali con molla H. cm 50.**  
Single-hole single lever mixer for industrial kitchen with H. cm 50 spring.  
Mitigeur évier monotrou pour cuisine industriel 50 cm h.  
Einhand-Spültischbatterie für industrielle Küche 50 cm h.  
Monoagujero para cocinas industrial con muella H. cm 50.  
Смеситель монокомандный для кухни

Articolo	Note	CROMO	PV	C	BO-NO-NKO
6550	FU	350,00	•	•	•

MR0031

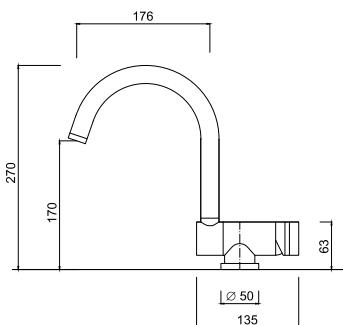
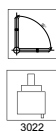

**Monocomando livello monoforo canna abbattibile.**  
Single-hole single-lever mixer for sink retractable spout.  
Mitigeur évier sous fenetre avec bec pliant  
Einhand-Spültischbatterie mit kippbarem Auslauf für Vor-Fenster-Montage  
Monomando fregadero monoagujero caño abatible.  
Однорычажный Смеситель для мойки складные тростки.

Articolo	Note	CROMO	PV	C	BO-NO-NKO
MR0031	MY	269,00	296,00	323,00	390,00

6530

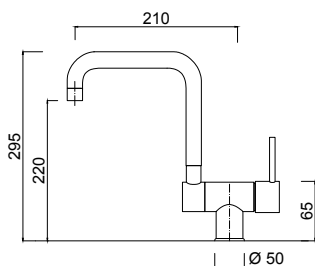
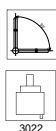

**Monocomando livello monoforo canna abbattibile.**  
Single-hole single-lever mixer for sink retractable spout.  
Mitigeur évier sous fenetre avec bec pliant  
Einhand-Spültischbatterie mit kippbarem Auslauf für Vor-Fenster-Montage  
Monomando fregadero monoagujero caño abatible.  
Однорычажный Смеситель для мойки складные тростки.

Articolo	Note	CROMO	PV	C	BO-NO-NKO
6530	FU	253,00	•	•	•

MAS 02

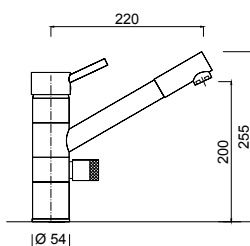
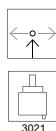

**Miscelatore a 3 vie per acque depurate**  
3 ways kitchen mixer (Hot, cold and filtered water)  
Mitigeur 3-voies pour l'eau potable  
Einhebelmischer mit getrennte Ausläufe für normales und gefiltertes Trinkwasser  
Misturador 3 vias para agua purifi cada  
Смеситель на 3 отверстия с функцией очистки воды

Articolo	Note	CROMO	PV	C	BO-NO-NKO
MAS 02		420,00	•	•	•

MR0151

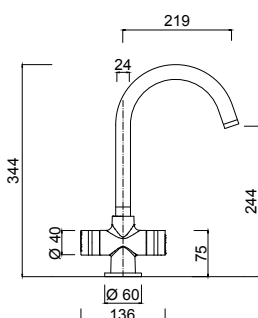

**Monoforo livello cucina, bocca girevole (con flessibile)**  
Single-hole mixer for sink, swivel spout (with flexible).  
Mélangeur monotrou évier, bec mobile (avec flexible).  
Einlochbatterie für Spülbecken, Rohauslauf (mit flexiblen Anschlusschläuchen).  
Monoagujero fregadero, caño giratorio (con flexible).  
Смеситель на одно отверстие для мойки, поворотный излив (гибкая подводка).

Articolo	Note	CROMO	PV	C	BO-NO-NKO
MR0151	MY	317,00	349,00	380,00	459,00

7651

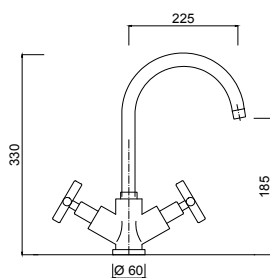

**Monoforo lavello cucina, bocca girevole (con flessibile)**

Single-hole mixer for sink, swivel spout (with flexible).  
Mélangeur monotrou évier, bec mobile (avec flexible).  
Einlochbatterie für Spülbecken, Rohrauslauf (mit flexiblen Anschlusschläuchen).  
Monoagujero fregadero, caño giratorio (con flexible).  
Смеситель на одно отверстие для мойки, поворотный излив (гибкая подводка).

Articolo	Note	CROMO	PV	C	BO-NO-NKO
7651	G3	196,00	•	•	265,00

7751

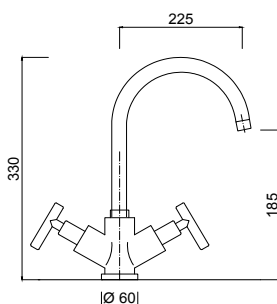

**Monoforo lavello cucina, bocca girevole (con flessibile)**

Single-hole mixer for sink, swivel spout (with flexible).  
Mélangeur monotrou évier, bec mobile (avec flexible).  
Einlochbatterie für Spülbecken, Rohrauslauf (mit flexiblen Anschlusschläuchen).  
Monoagujero fregadero, caño giratorio (con flexible).  
Смеситель на одно отверстие для мойки, поворотный излив (гибкая подводка).

Articolo	Note	CROMO	PV	C	BO-NO-NKO
7751	G4	196,00	•	•	265,00

3651/S

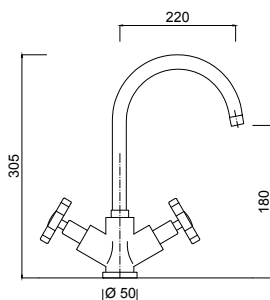

**Monoforo lavello cucina, bocca girevole (con flessibile)**

Single-hole mixer for sink, swivel spout (with flexible).  
Mélangeur monotrou évier, bec mobile (avec flexible).  
Einlochbatterie für Spülbecken, Rohrauslauf (mit flexiblen Anschlusschläuchen).  
Monoagujero fregadero, caño giratorio (con flexible).  
Смеситель на одно отверстие для мойки, поворотный излив (гибкая подводка).

Articolo	Note	CROMO	PV	C	BO-NO-BR
3651/S	GC	292,00	•	•	410,00
3651	G	272,00	•	•	390,00

6502

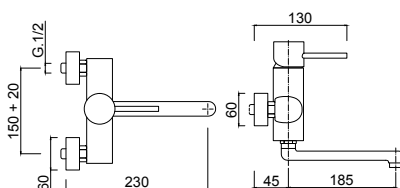
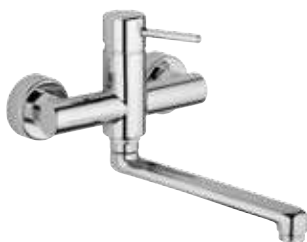

**Monocomando lavello a parete.**

Sink single-lever mixer, wall mounting.  
Mitigeur évier mural  
Einhand-Spültischbatterie Wandmontage  
Monomando fregadero pegado al muro.  
Однорычажный настенный

Articolo	Note	CROMO	PV	C	BO-NO-NKO
6502	FU	225,00	•	•	304,00

7602

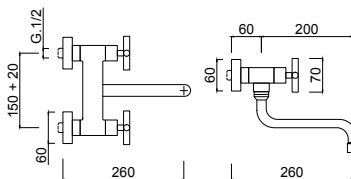

**Gruppo lavello a parete.**  
*Sink set, wall mounting.*  
*Mélangeur évier mural.*  
*Spültischbatterie Wandmontage.*  
*Grupo fregadero de pared.*  
*Настенный смеситель для кухни.*

Articolo	Note	CROMO	PV	C	BO-NO-NKO
7602	G3	213,00	•	•	288,00

7702

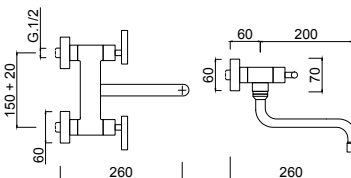

**Gruppo lavello a parete.**  
*Sink set, wall mounting.*  
*Mélangeur évier mural.*  
*Spültischbatterie Wandmontage.*  
*Grupo fregadero de pared.*  
*Настенный смеситель для кухни.*

Articolo	Note	CROMO	PV	C	BO-NO-NKO
7702	G4	213,00	•	•	288,00

3602/S

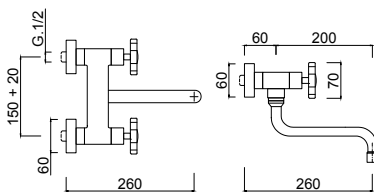

**Gruppo lavello a parete.**  
*Sink set, wall mounting.*  
*Mélangeur évier mural.*  
*Spültischbatterie Wandmontage.*  
*Grupo fregadero de pared.*  
*Настенный смеситель для кухни.*

Articolo	Note	CROMO	PV	C	BO-NO-BR
3602/S	GC	301,00	•	•	420,00
3602	G	281,00	•	•	405,00



GIÒ

Classico





7520

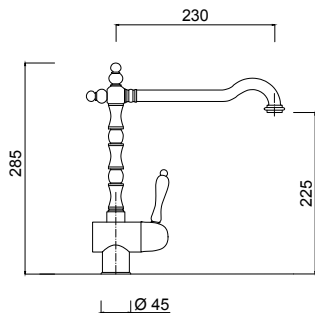

**Monocomando lavello cucina, bocca girevole (con flessibile)**

Single-hole single-lever mixer for sink, swivel spout (with flexible).  
Mitigeur évier monotrou, bec mobile (avec flexible).  
Einloch- Einhebelmischer für Spülbecken, Rohrauslauf (mit flexiblen Anschlusschläuchen).  
Monomando monoagujero fregadero, caño giratorio (con flexible).  
Однорычажный смеситель на одно отверстие для мойки, поворотный излив (гибкая подводка).

Articolo	Note	CROMO	CR	CO-AR-BR-VR	O
7520	PRM	209,00	230,00	303,00	376,00
7520L	PRML	215,00	236,00	309,00	382,00
7520CE	PRMCE	219,00	240,00	313,00	386,00
7520/S	PRS	259,00	280,00	353,00	426,00
7220	LNМ	205,00	226,00	299,00	372,00

2614

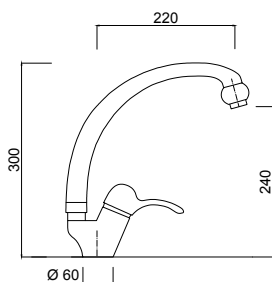

**Monocomando lavello cucina, bocca girevole (con flessibile)**

Single-hole single-lever mixer for sink, swivel spout (with flexible).  
Mitigeur évier monotrou, bec mobile (avec flexible).  
Einloch- Einhebelmischer für Spülbecken, Rohrauslauf (mit flexiblen Anschlusschläuchen).  
Monomando monoagujero fregadero, caño giratorio (con flexible).  
Однорычажный смеситель на одно отверстие для мойки, поворотный излив (гибкая подводка).

Articolo	Note	CROMO	CR	CO-AR-BR-VR	O
2614	RM	162,00	178,00	235,00	292,00

9516

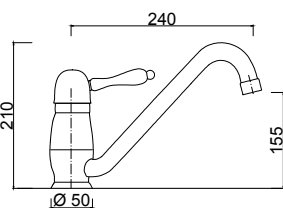

**Monocomando lavello cucina, bocca girevole (con flessibile)**

Single-hole single-lever mixer for sink, swivel spout (with flexible).  
Mitigeur évier monotrou, bec mobile (avec flexible).  
Einloch- Einhebelmischer für Spülbecken, Rohrauslauf (mit flexiblen Anschlusschläuchen).  
Monomando monoagujero fregadero, caño giratorio (con flexible).  
Однорычажный смеситель на одно отверстие для мойки, поворотный излив (гибкая подводка).

Articolo	Note	CROMO	CR	CO-AR-BR-VR	O
9516	HA	167,00	184,00	242,00	300,00
9516L	HAL	173,00	190,00	248,00	306,00
9516CE	HACE	177,00	194,00	252,00	310,00
9516/S	HAS	217,00	234,00	292,00	350,00
9616	LB	171,00	188,00	246,00	304,00

9517

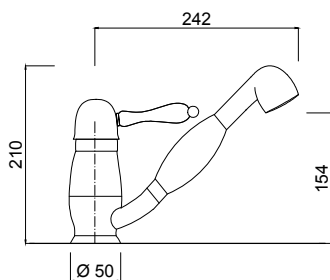
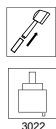

**Monocomando lavello monoforo con doccia estraibile a due getti**

Single-hole single-lever mixer for sink double jet with extractable shower  
Mitigeur évier avec douchette 2-jets extractible  
Einhand-Spültischbatterie mit herausziehbarer Brause/Strahlart  
Monomando fregadero monoagujero ducha extraíble  
Смеситель для кухонной раковины на одно отверстие с выдвигаемым душем на 2 струи

Articolo	Note	CROMO	CR	CO-AR-BR-VR	O
9517	HA	247,00	272,00	358,00	444,00
9517L	HAL	253,00	278,00	364,00	450,00
9517CE	HACE	257,00	282,00	368,00	454,00
9517/S	HAS	297,00	322,00	408,00	494,00
9617	LB	251,00	276,00	362,00	448,00

9530

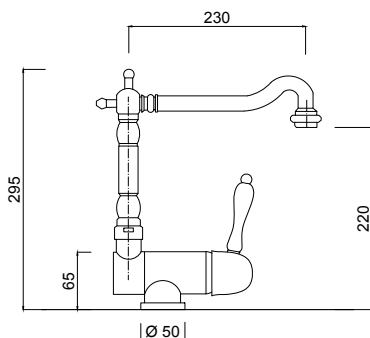
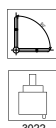

**Monocomando lavello monoforo canna abbattibile.**

Single-hole single-lever mixer for sink retractable spout.  
Mitigeur évier sous fenetre avec bec pliant  
Einhand-Spültischbatterie mit kippbarem Auslauf für Vor-Fenster-Montage  
Monomando fregadero monoagujero caño abatible.  
Однорычажный Смеситель для мойки складные тростки.

Articolo	Note	CROMO	CR	CO-AR-BR-VR	O
9530	HA	275,00	303,00	399,00	495,00
9530L	HAL	281,00	309,00	405,00	501,00
9530CE	HACE	285,00	313,00	409,00	505,00
9530/S	HAS	325,00	353,00	449,00	545,00
9630	LB	279,00	307,00	403,00	499,00

**S7550**

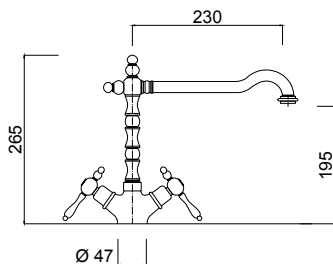

**Monoforo cucina (con flessibile)**

Single-hole mixer for sink (with flexible)  
Mélangeur monotrou évier (avec flexible)  
Spültisch-Einlochbatterie ( mit flexiblen Anschlusschlaeuchen)  
Monoagujero (con flexible)  
Смеситель для кухни (гибкая подводка)

Articolo	Note	CROMO	CR	CO-AR-BR-VR	O
<b>S7550</b>	PR	219,00	241,00	307,00	394,00
<b>S7550L</b>	PRL	231,00	253,00	319,00	406,00
<b>S7550CE</b>	PRCE	239,00	261,00	327,00	414,00
<b>S7550/S</b>	PRS	319,00	341,00	407,00	494,00
<b>S7250</b>	LN	211,00	233,00	299,00	386,00

**S7350**

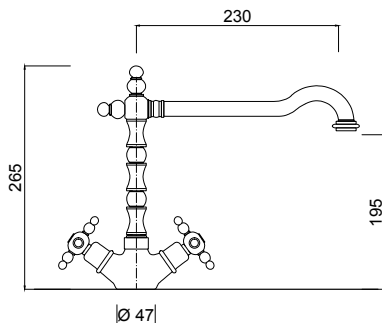
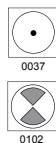

**Monoforo cucina (con flessibile)**

Single-hole mixer for sink (with flexible)  
Mélangeur monotrou évier (avec flexible)  
Spültisch-Einlochbatterie ( mit flexiblen Anschlusschlaeuchen)  
Monoagujero (con flexible)  
Смеситель для кухни (гибкая подводка)

Articolo	Note	CROMO	CR	CO-AR-BR-VR	O
<b>S7350</b>	PA	209,00	230,00	293,00	376,00
<b>S7450</b>	PAV	202,00	222,00	282,00	363,00

**S3750**

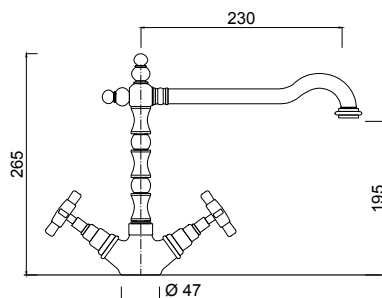

**Monoforo cucina (con flessibile)**

Single-hole mixer for sink (with flexible)  
Mélangeur monotrou évier (avec flexible)  
Spültisch-Einlochbatterie ( mit flexiblen Anschlusschlaeuchen)  
Monoagujero (con flexible)  
Смеситель для кухни (гибкая подводка)

Articolo	Note	CROMO	CR	CO-AR-BR-VR	O
<b>S3750</b>	KN	239,00	263,00	346,00	430,00

**7951**

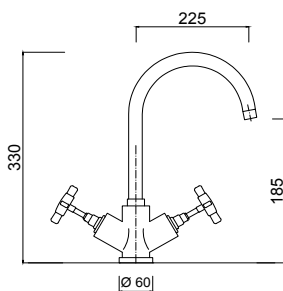

**Monoforo cucina (con flessibile)**

Single-hole mixer for sink (with flexible)  
Mélangeur monotrou évier (avec flexible)  
Spültisch-Einlochbatterie ( mit flexiblen Anschlusschlaeuchen)  
Monoagujero (con flexible)  
Смеситель для кухни (гибкая подводка)

Articolo	Note	CROMO	CR	CO-AR-BR-VR	O
<b>7951</b>	G5	232,00	255,00	336,00	417,00

**7551**

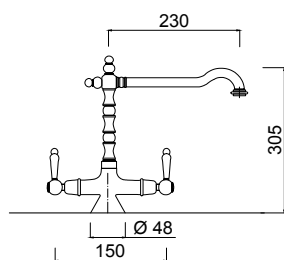

**Monoforo cucina (con flessibile)**

Single-hole mixer for sink (with flexible)  
Mélangeur monotrou évier (avec flexible)  
Spültisch-Einlochbatterie ( mit flexiblen Anschlusschlaeuchen)  
Monoagujero (con flexible)  
Смеситель для кухни (гибкая подводка)

Articolo	Note	CROMO	CR	CO-AR-BR-VR	O
<b>7551</b>	PR	222,00	244,00	322,00	399,00
<b>7551L</b>	PRL	234,00	256,00	334,00	411,00
<b>7551CE</b>	PRCE	242,00	264,00	342,00	419,00
<b>7551/S</b>	PRS	322,00	344,00	422,00	499,00
<b>7251</b>	LN	214,00	236,00	314,00	391,00

**7551P**

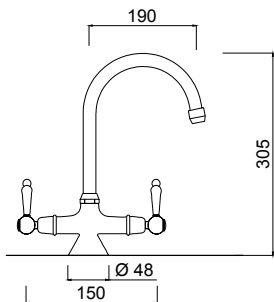

**Monoforo cucina (con flessibile)**

Single-hole mixer for sink (with flexible)  
Mélangeur monotrou évier (avec flexible)  
Spültisch-Einlochbatterie ( mit flexiblen Anschlusschlaeuchen)  
Monoagujero (con flexible)  
Смеситель для кухни (гибкая подводка)

Articolo	Note	CROMO	CR	CO-AR-BR-VR	O
7551P	PR	159,00	175,00	231,00	286,00
7551PL	PRL	171,00	187,00	243,00	298,00
7551PCE	PRCE	179,00	195,00	251,00	306,00
7551P/S	PRS	259,00	275,00	331,00	386,00
7251P	LN	151,00	167,00	223,00	278,00

**7509**

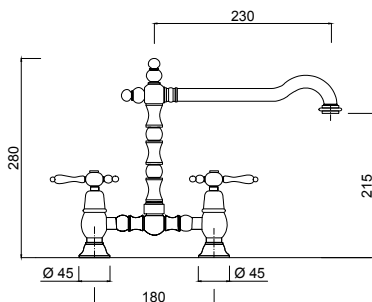

**Gruppo lavello a ponte**

Sink mixer  
Mélangeur d'évier  
Einloch-Waschbecken  
Mezclador fregadero  
Смеситель для кухонной раковины

Articolo	Note	CROMO	CR	CO-AR-BR-VR	O
7509	PR	286,00	314,00	415,00	515,00
7509L	PRL	298,00	326,00	427,00	527,00
7509CE	PRCE	306,00	334,00	435,00	535,00
7509/S	PRS	386,00	414,00	515,00	615,00
7209	LN	278,00	306,00	407,00	507,00

**7309**

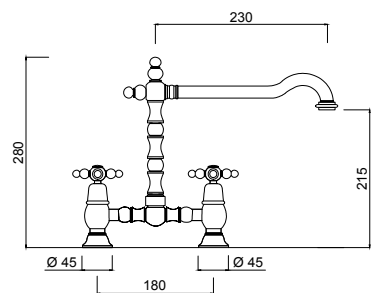

**Gruppo lavello a ponte**

Sink mixer  
Mélangeur d'évier  
Einloch-Waschbecken  
Mezclador fregadero  
Смеситель для кухонной раковины

Articolo	Note	CROMO	CR	CO-AR-BR-VR	O
7309	PA	274,00	301,00	397,00	493,00
7409	PAV	267,00	294,00	390,00	486,00

**3709**

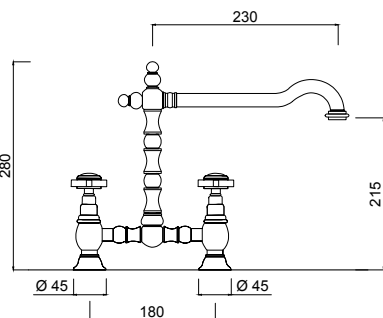

**Gruppo lavello a ponte**

Sink mixer  
Mélangeur d'évier  
Einloch-Waschbecken  
Mezclador fregadero  
Смеситель для кухонной раковины

Articolo	Note	CROMO	CR	CO-AR-BR-VR	O
3709	KN	287,00	315,00	416,00	516,00

**7509P**

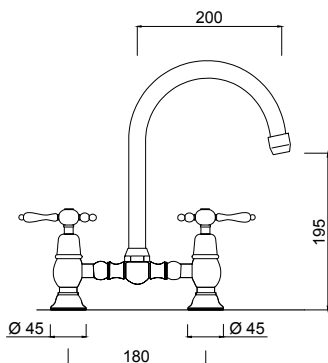

**Gruppo lavello a ponte**

Sink mixer  
Mélangeur d'évier  
Einloch-Waschbecken  
Mezclador fregadero  
Смеситель для кухонной раковины

Articolo	Note	CROMO	CR	CO-AR-BR-VR	O
7509P	PR	236,00	260,00	342,00	424,00
7509PL	PRL	248,00	272,00	354,00	436,00
7509PCE	PRCE	256,00	280,00	362,00	444,00
7509P/S	PRS	336,00	360,00	442,00	524,00
7209P	LN	228,00	252,00	334,00	416,00

7309P

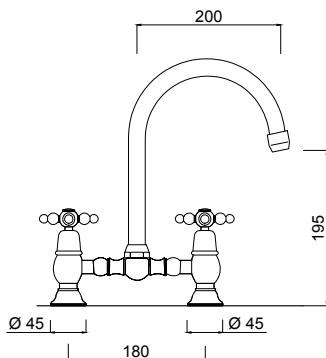

**Gruppo lavello a ponte**

Sink mixer  
Mélangeur d'évier  
Einloch-Waschbecken  
Mezclador fregadero  
Смеситель для кухонной раковины

Articolo	Note	CROMO	CR	CO-AR-BR-VR	O
7309P	PA	224,00	246,00	324,00	403,00
7409P	PAV	217,00	239,00	317,00	396,00

3709P

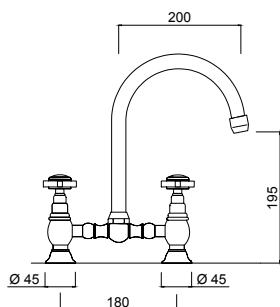

**Gruppo lavello a ponte**

Sink mixer  
Mélangeur d'évier  
Einloch-Waschbecken  
Mezclador fregadero  
Смеситель для кухонной раковины

Articolo	Note	CROMO	CR	CO-AR-BR-VR	O
3709P	KN	254,00	279,00	368,00	457,00

S559

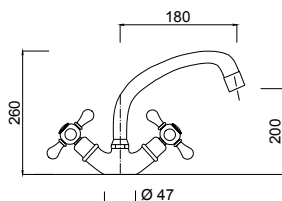

**Monoforo canna jota (con flessibile).**

Single-hole mixer with jota spout (with flexible).  
Mélangeur monotrou avec bec jota (avec flexible).  
Spültischeinlochhahn mit jota Auslauf (mit flexiblen Anschlusschläuchen)  
Monoagujero caño jota (con flexible).  
Смеситель для кухни (гибкая подводка)

Articolo	Note	CROMO	CR	CO-AR-BR-VR	O
S559	LO	117,00	128,00	170,00	•

S552

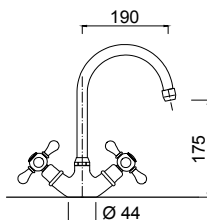

**Monoforo canna ponte (con flessibile).**

Single-hole mixer with bridge spout (with flexible).  
Mélangeur monotrou avec bec à pont (avec flexible).  
Spültischeinlochhahn mit Brücken Auslauf (mit flexiblen Anschlusschläuchen)  
Monoagujero caño ponte (con flexible).  
Смеситель для кухни (гибкая подводка)

Articolo	Note	CROMO	CR	C-CO-AR-VR	O
S552	LO	120,00	132,00	174,00	216,00

0584

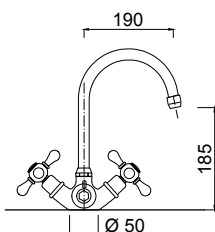

**Monoforo 3 vie canna ponte (con tubetto saldato).**

3-way single-hole mixer with bridge spout (with welded tube).  
Mélangeur monotrou 3 voies avec bec à pont (avec flexible).  
3-Wege Spültischeinlochhahn mit Brücken Auslauf (mit flexiblen Anschlusschläuchen)  
Monoagujero 3 vías caño puente (con tubo soldado).  
3-полосная стержне отверстие моста (с трубкой сварные).

Articolo	Note	CROMO	CR	CO-AR-BR-VR	O
0584	LO	210,00	•	•	•

S554

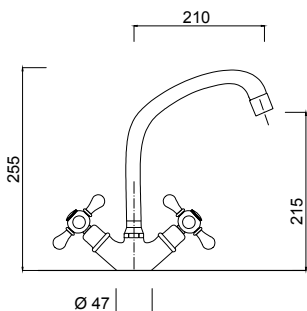

**Monoforo lusso (con flessibile).**

Luxury single-hole mixer (with flexible).  
Mélangeur monotrou de luxe (avec flexible).  
Luxus Spültischeinlochhahn (mit flexiblen Anschlusschläuchen)  
Monoagujero lujo (con flexible).  
Смеситель для кухни (гибкая подводка)

Articolo	Note	CROMO	CR	C-CO-R-BR	O
S554	LO	145,00	150,00	210,00	261,00

9502

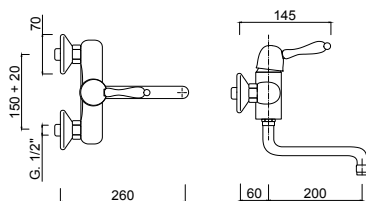

**Monocomando lavello a parete**

Sink single-lever mixer, wall mounting  
Mitigeur évier mural  
Einhand-Spültischbatterie Wandmontage  
Monomando fregadero pegado al muro  
Однорычажный настенный для раковины

Articolo	Note	CROMO	CR	CO-AR-BR-VR	O
9502	HA	128,00	141,00	186,00	230,00
9502L	HAL	134,00	147,00	192,00	236,00
9502CE	HACE	138,00	151,00	196,00	240,00
9502/S	HAS	178,00	191,00	236,00	280,00
9602	LB	132,00	145,00	190,00	234,00

7502

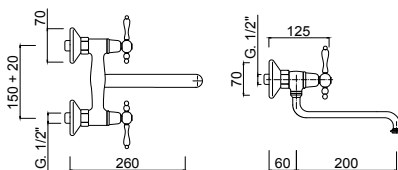

**Gruppo lavello a parete.**

Sink set, wall mounting.  
Mélangeur évier mural.  
Spültischbatterie Wandmontage.  
Grupo fregadero de pared.  
Настенный смеситель для кухни.

Articolo	Note	CROMO	CR	CO-AR-BR-VR	O
7502	PR	151,00	166,00	219,00	272,00
7502L	PRL	163,00	178,00	231,00	284,00
7502CE	PRCE	171,00	186,00	239,00	292,00
7502/S	PRSE	251,00	266,00	319,00	372,00
7202	LN	143,00	158,00	211,00	264,00

7302

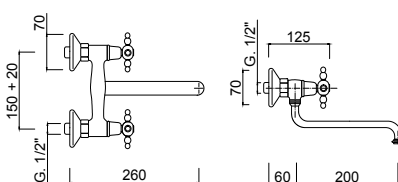

**Gruppo lavello a parete.**

Sink set, wall mounting.  
Mélangeur évier mural.  
Spültischbatterie Wandmontage.  
Grupo fregadero de pared.  
Настенный смеситель для кухни.

Articolo	Note	CROMO	CR	CO-AR-BR-VR	O
7302	PA	136,00	150,00	197,00	244,00
3702	KN	152,00	166,00	213,00	260,00
7402	PAV	129,00	143,00	190,00	237,00

0502

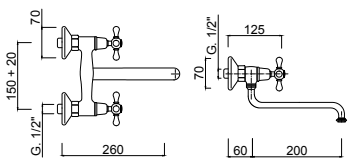

**Gruppo lavello a parete.**

Sink set, wall mounting.  
Mélangeur évier mural.  
Spültischbatterie Wandmontage.  
Grupo fregadero de pared.  
Настенный смеситель для кухни.

Articolo	Note	CROMO	CR	CO-AR-BR-VR	O
0502	LO	120,00	132,00	174,00	•
7002	LOV	127,00	140,00	184,00	•
7102	V	127,00	140,00	184,00	•

7508

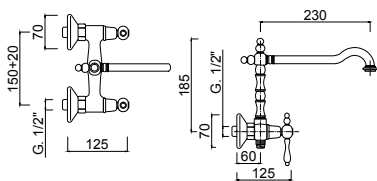

**Gruppo lavello a parete bocca alta**  
*Sink set, wall mounting.*  
*Mélangeur évier mural.*  
*Spueltschbatterie Wandmontage.*  
*Grupo fregadero de pared.*  
*Настенный смеситель для кухни.*

Articolo	Note	CROMO	CR	CO-AR-BR-VR	O
7508	PR	203,00	223,00	294,00	365,00
7508L	PRL	215,00	235,00	306,00	377,00
7508CE	PRCE	223,00	243,00	314,00	385,00
7508/S	PRS	303,00	323,00	394,00	465,00
7208	LN	195,00	215,00	286,00	357,00

7308

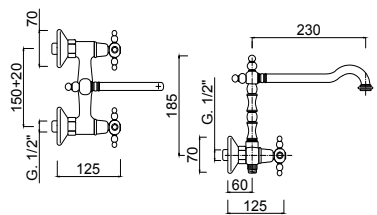

**Gruppo lavello a parete bocca alta**  
*Sink set, wall mounting.*  
*Mélangeur évier mural.*  
*Spueltschbatterie Wandmontage.*  
*Grupo fregadero de pared.*  
*Настенный смеситель для кухни.*

Articolo	Note	CROMO	CR	CO-AR-BR-VR	O
7308	PA	192,00	211,00	278,00	345,00
3708	KN	208,00	227,00	294,00	361,00
7408	PAV	185,00	204,00	271,00	238,00



PRAGAMIX - HARMONY



PRM/HA - RESINA BIANCA



PRMCE/HACE - CERAMICA BIANCA



PRMCE/HACE - CERAMICA NERA



PRMS/HAS - SWAROVSKI LIGHT



PRMS/HAS - SWAROVSKI NERO



PRL/HAL - WENGÉ



PRL/HAL - TEAK



PRAGA



PR - RESINA BIANCA



PRCE - CERAMICA BIANCA



PRCE - CERAMICA NERA



PRS - SWAROVSKI LIGHT



PRS - SWAROVSKI NERO



PRL - WENGÉ



PRL - TEAK



LB - LIBERTY



LN - LONDRA



LNM - LONDRA MIX



V - VIENNA

Contemporary





6314

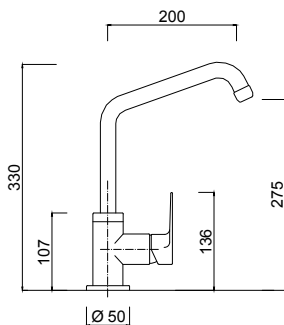

**Monocomando lavello cucina, bocca girevole (con flessibile)**  
Single-hole single-lever mixer for sink, swivel spout (with flexible).  
Mitigeur évier monotrou, bec mobile (avec flexible).  
Einloch- Einhebelmischer für Spülbecken, Rohrauslauf (mit flexiblen Anschlusschläuchen).  
Monomando monoagujero fregadero, caño giratorio (con flexible).  
Однорычажный смеситель на одно отверстие для мойки, поворотный излив (гибкая подводка).

Articolo	Note	CROMO	C	FL-BR	SF
6314	LN	134,00	•	•	•
6414	LD	134,00	•	•	•

9314

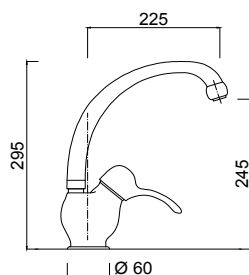

**Monocomando lavello cucina, bocca girevole (con flessibile)**  
Single-hole single-lever mixer for sink, swivel spout (with flexible).  
Mitigeur évier monotrou, bec mobile (avec flexible).  
Einloch- Einhebelmischer für Spülbecken, Rohrauslauf (mit flexiblen Anschlusschläuchen).  
Monomando monoagujero fregadero, caño giratorio (con flexible).  
Однорычажный смеситель на одно отверстие для мойки, поворотный излив (гибкая подводка).

Articolo	Note	CROMO	C	FL-BR	SF
9314	EP	156,00	•	•	•

8514

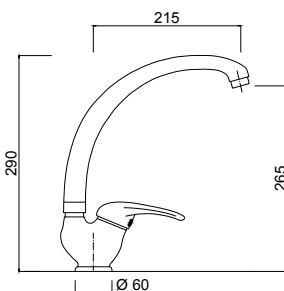

**Monocomando lavello cucina, bocca girevole (con flessibile)**  
Single-hole single-lever mixer for sink, swivel spout (with flexible).  
Mitigeur évier monotrou, bec mobile (avec flexible).  
Einloch- Einhebelmischer für Spülbecken, Rohrauslauf (mit flexiblen Anschlusschläuchen).  
Monomando monoagujero fregadero, caño giratorio (con flexible).  
Однорычажный смеситель на одно отверстие для мойки, поворотный излив (гибкая подводка).

Articolo	Note	CROMO	C	FL-BR	SF
8514	IN	145,00	•	•	•
8614	SP	145,00	•	•	•

2520

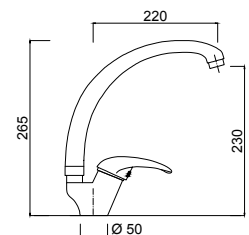

**Monocomando lavello cucina, bocca girevole (con flessibile)**  
Single-hole single-lever mixer for sink, swivel spout (with flexible).  
Mitigeur évier monotrou, bec mobile (avec flexible).  
Einloch- Einhebelmischer für Spülbecken, Rohrauslauf (mit flexiblen Anschlusschläuchen).  
Monomando monoagujero fregadero, caño giratorio (con flexible).  
Однорычажный смеситель на одно отверстие для мойки, поворотный излив (гибкая подводка).

Articolo	Note	CROMO	C	FL-BR	SF
2520	KE	137,00	164,00	198,00	178,00
2420	ME	137,00	164,00	198,00	178,00
0407	GL	137,00	164,00	198,00	178,00

2220

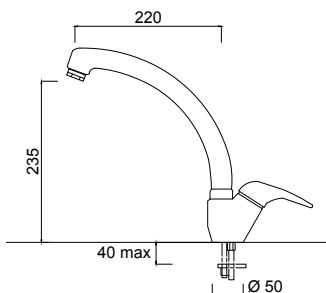

**Monocomando lavello cucina, bocca girevole (con flessibile)**  
Single-hole single-lever mixer for sink, swivel spout (with flexible).  
Mitigeur évier monotrou, bec mobile (avec flexible).  
Einloch- Einhebelmischer für Spülbecken, Rohrauslauf (mit flexiblen Anschlusschläuchen).  
Monomando monoagujero fregadero, caño giratorio (con flexible).  
Однорычажный смеситель на одно отверстие для мойки, поворотный излив (гибкая подводка).

Articolo	Note	CROMO	C	FL-BR	SF
2220	GI	122,00	•	•	•
2120	GIL	122,00	•	•	•

2514

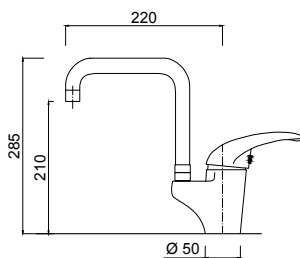

**Monocomando lavello cucina, bocca girevole (con flessibile)**  
Single-hole single-lever mixer for sink, swivel spout (with flexible).  
Mitigeur évier monotrou, bec mobile (avec flexible).  
Einloch- Einhebelmischer für Spülbecken, Rohrauslauf (mit flexiblen Anschlusschläuchen).  
Monomando monoagujero fregadero, caño giratorio (con flexible).  
Однорычажный смеситель на одно отверстие для мойки, поворотный излив (гибкая подводка).

Articolo	Note	CROMO	C	FL-BR	SF
2514	KE	145,00	174,00	210,00	188,00
2414	ME	145,00	174,00	210,00	188,00
0405	GL	145,00	174,00	210,00	188,00

9416

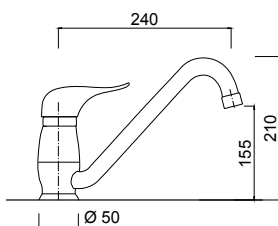

**Monocomando lavello cucina, bocca girevole (con flessibile)**  
Single-hole single-lever mixer for sink, swivel spout (with flexible).  
Mitigeur évier monotrou, bec mobile (avec flexible).  
Einloch- Einhebelmischer für Spülbecken, Rohrauslauf (mit flexiblen Anschlusschläuchen).  
Monomando monoagujero fregadero, caño giratorio (con flexible).  
Однорычажный смеситель на одно отверстие для мойки, поворотный излив (гибкая подводка).

Articolo	Note	CROMO	C	BR	SF
9416	MD	147,00	•	213,00	•
9316	EP	147,00	•	213,00	•

2516

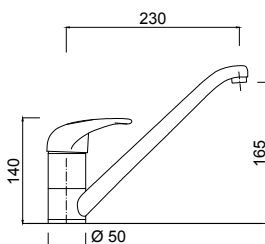

**Monocomando lavello cucina, bocca girevole (con flessibile)**  
Single-hole single-lever mixer for sink, swivel spout (with flexible).  
Mitigeur évier monotrou, bec mobile (avec flexible).  
Einloch- Einhebelmischer für Spülbecken, Rohrauslauf (mit flexiblen Anschlusschläuchen).  
Monomando monoagujero fregadero, caño giratorio (con flexible).  
Однорычажный смеситель на одно отверстие для мойки, поворотный излив (гибкая подводка).

Articolo	Note	CROMO	C	FL-BR	SF
2516	KE	110,00	132,00	159,00	143,00
2416	ME	110,00	132,00	159,00	143,00
8516	IN	110,00	•	•	•
8616	SP	110,00	•	•	•
0416	GL	110,00	132,00	159,00	143,00
0416LC	LC	124,00	•	•	•

2216

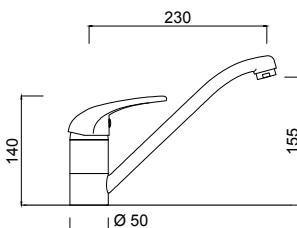

**Monocomando lavello cucina, bocca girevole (con flessibile)**  
Single-hole single-lever mixer for sink, swivel spout (with flexible).  
Mitigeur évier monotrou, bec mobile (avec flexible).  
Einloch- Einhebelmischer für Spülbecken, Rohrauslauf (mit flexiblen Anschlusschläuchen).  
Monomando monoagujero fregadero, caño giratorio (con flexible).  
Однорычажный смеситель на одно отверстие для мойки, поворотный излив (гибкая подводка).

Articolo	Note	CROMO	C	FL-BR	SF
2216	GI	94,00	•	•	•
2116	GIL	94,00	•	•	•
2216LC	LC	108,00	•	•	•

2517

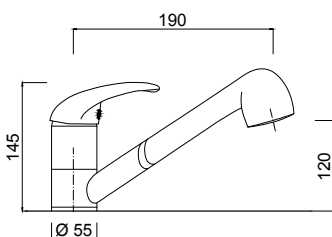
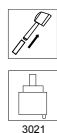

**Monocomando lavello monoforo con doccia estraibile a due getti**  
Single-hole single-lever mixer for sink double jet with extractable shower  
Mitigeur évier avec douchette 2-jets extractible  
Einhand-Spültischbatterie mit herausziehbarer Brause/Strahlart  
Monomando fregadero monoagujero ducha extraible  
Смеситель для кухонной раковины на одно отверстие с выдвигаемым душем на 2 струи

Articolo	Note	CROMO	C	FL-BR	SF
2517	KE	146,00	•	•	•
2417	ME	146,00	•	•	•
8517	IN	146,00	•	•	•
8617	SP	146,00	•	•	•
0406	GL	146,00	•	•	•
2217	GI	146,00	•	•	•

9402

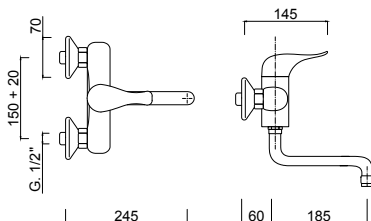

**Monocomando lavello a parete**  
Sink single-lever mixer, wall mounting  
Mitigeur évier mural  
Einhand-Spültischbatterie Wandmontage  
Monomando fregadero pegado al muro  
Однорычажный настенный для раковины

Articolo	Note	CROMO	C	BR	SF
9402	MD	107,00	•	155,00	•
9302	EP	107,00	•	155,00	•

2502

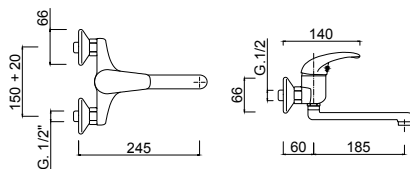

**Monocomando lavello a parete**  
Sink single-lever mixer, wall mounting  
Mitigeur évier mural  
Einhand-Spültischbatterie Wandmontage  
Monomando fregadero pegado al muro  
Однорычажный настенный для раковины

Articolo	Note	CROMO	C	FL-BR	SF
2502	KE	125,00	150,00	181,00	162,00
2402	ME	125,00	150,00	181,00	162,00
8502/2102	IN	125,00	•	•	•
8602	SP	125,00	•	•	•
0402/2202	GL	125,00	150,00	181,00	162,00
0402LC	LC	139,00	•	•	•

MAS 01

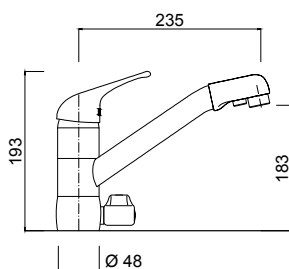

**Miscelatore a 3 vie per acque depurate**  
3 ways kitchen mixer (Hot, cold and filtered water)  
Mitigeur 3-voies pour l'eau potable  
Einhebelmischer mit getrennte Ausläufe für normales und gefiltertes Trinkwasser  
Misturador 3 vias para agua purificada  
Смеситель на 3 отверстия с функцией очистки воды

Articolo	Note	CROMO	C	FL-BR	SF
MAS 01		356,00	•	•	•

2524

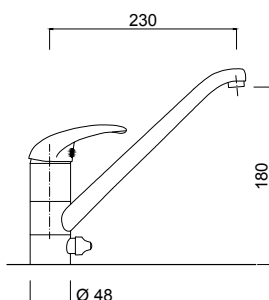

**Monocomando lavello monoforo attacco lavastoviglie**  
Single-hole single-lever mixer for sink, connection for dishwasher  
Mitigeur évier avec connexion lave-vaisselle intégrée  
Einhand-Spültischbatterie mit Absperrung für Spül- oder Waschmaschine  
Monomando fregadero monoagujero acometida lavavajillas  
Одноместный раковина смеситель посудомоечная машина связи

Articolo	Note	CROMO	C	FL-BR	SF
2524	KE	184,00	•	•	•
2424	ME	184,00	•	•	•
0409	GL	184,00	•	•	•

0761



**Monoforo canna jota**

Single-hole mixer with jota spout  
Mélangeur monotrou avec bec jota  
Spültischeinlochhahn mit jota Auslauf  
Monoagujero caño jota  
Смеситель для кухни (гибкая подводка)

Articolo	Note	CROMO	C	FL-BR	SF
0761	O7	93,00	•	•	•
0761G	MM	93,00	•	•	•

0752



**Monoforo canna ponte**

Single-hole mixer with bridge spout  
Mélangeur monotrou avec beca à pont  
Spültischeinlochhahn mit Brücken Auslauf  
Monoagujero caño ponte  
Смеситель для кухни (гибкая подводка)

Articolo	Note	CROMO	C	FL-BR	SF
0752	O7	104,00	•	•	•
0752G	MM	104,00	•	•	•

0785



**Monoforo lavastoviglie canna ponte**

Single-hole mixer for dish-washer with bridge spout  
Mélangeur monotrou avec commection lave-vaisselle avec beca à pont  
Spültischeinlochhahn und Absperrung für Spül oder Waschmaschine mit Brücken Auslauf  
Monoagujero lavavajillas caño puente  
Посудомоечная машина отверстие ствола мост

Articolo	Note	CROMO	C	FL-BR	SF
0785	O7	133,00	•	•	•
0785G	MM	133,00	•	•	•

0784



**Monoforo 3 vie canna ponte**

3-way single-hole mixer with bridge spout  
Mélangeur monotrou 3 voies avec bec à pont  
3-Wege Spültischeinlochhahn mit Brücken Auslauf  
Monoagujero 3 vias caño puente  
3-полосный мост стержне отверстие

Articolo	Note	CROMO	C	FL-BR	SF
0784	O7	166,00	•	•	•
0784G	MM	166,00	•	•	•

0759



**Monoforo con doccia**

Single-hole mixer with shower  
Mélangeur monotrou avec douche  
Spültischeinlochahn mit Herausziehbarer  
Monoaguiero con ducha  
Смеситель с душем

Articolo	Note	CROMO	C	FL-BR	SF
0759	O7	161,00	•	•	•
0759G	MM	161,00	•	•	•

0702



**Gruppo lavello a parete.**

Sink set, wall mounting.  
Mélangeur évier mural.  
Spültischbatterie Wandmontage.  
Grupo fregadero de pared.  
Настенный смеситель для кухни.

Articolo	Note	CROMO	C	FL-BR	SF
0702	O7	84,00	•	•	•
0702G	MM	84,00	•	•	•

0707



**Gruppo lavello attacco lavatrice.**

Sink set with connection for washing machine.  
Mélangeur évier avec enclenchement pour machine à laver.  
Spültischbatterie mit Anschluß für die Geschirrwashmaschine.  
Grupo fregadero acometida lavadora.  
Смеситель для раковины с соединителем для стиральной машины.

Articolo	Note	CROMO	C	FL-BR	SF
0707	O7	128,00	•	•	•
0707G	MM	128,00	•	•	•



LADY



EPOCA



INFINITO



SPAZIO - GIADALUX



MERY



GOLDENLUX



LEVA CLINICA



MINERVA MINI

1538/M



**Doccia 2 getti per monoforo con doccia estraibile**

*Removable handshower for sink mixer with 2 jets.*

*Douchette bi-jets pour évier.*

*Brause mit 2 Strahlarten für Spültischbatterie.*

*Ducha dos posiciones para fregadero ducha extraible.*

*Съемный душ для мойки для двухструйного смесителя.*

Articolo	Note	CROMO	BR	O	
1538/M		40,00	•	•	

1538/A



**Doccia 2 getti per monoforo con doccia estraibile**

*Removable handshower for sink mixer with 2 jets.*

*Douchette bi-jets pour évier.*

*Brause mit 2 Strahlarten für Spültischbatterie.*

*Ducha dos posiciones para fregadero ducha extraible.*

*Съемный душ для мойки для двухструйного смесителя.*

Articolo	Note	CROMO	BR	O	
1538/A		47,00	66,00	88,00	

1538



**Doccia 2 getti per monoforo con doccia estraibile**

*Removable handshower for sink mixer with 2 jets.*

*Douchette bi-jets pour évier.*

*Brause mit 2 Strahlarten für Spültischbatterie.*

*Ducha dos posiciones para fregadero ducha extraible.*

*Съемный душ для мойки для двухструйного смесителя.*

Articolo	Note	CROMO	BR	O	
1538		25,00	•	•	

1578



**Flessibile senza piombo per monoforo doccia estraibile monocomandi.**

*Flexible without lead for single-lever extractable hand-shower.*

*Flexible sans plomb pour monotrou douchette extractible*

*Schlauch ohne Bleigewicht für Einlochmischer mit ausziehbarer Handbrause*

*Tubo flexible sin plomo para monomando ducha de teléfono extraible.*

*Гибкий шланг без заглушки для однорычажного смесителя для душевой лейки*

Articolo	Note	CROMO	BR	O	
1578		23,00	•	•	
1578-N	NYLON	15,00	•	•	

1579



**Piombo per flessibile.**

*Lead for flexible.*

*Plomb pour flexible*

*Bleigewicht für Schlauch*

*Plomo para tubo flexible.*

*Заглушка для гибкого шланга*

Articolo	Note	CROMO	BR	O	
1579		8,00	•	•	









# GG Project

*Il progetto su misura by GIULINI G.*

*The project tailored by GIULINI G.*

*Le projet sur mesure par GIULINI G.*

*Das Projekt zugeschnitten von GIULINI.G*

*El proyecto adaptado por GIULINI.G*

*Проект, разработанный GIULINI.G*











**MIS-100**

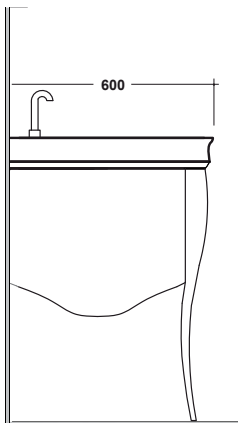

**Mobile con console cm.100 con pomello in swarovsky, cassetto con dispositivo soft closed, con kit per fissaggio al muro.**  
*Cabinet with cm.100 3-holes ceramic basin, with swarovsky knob, drawer with soft close system, including wall fixing kit*  
 Тумба с раковиной под смеситель на три отверстия с ручкой из кристалла swarovsky, выдвижной ящик с доводчиком, комплект, креплений к стене

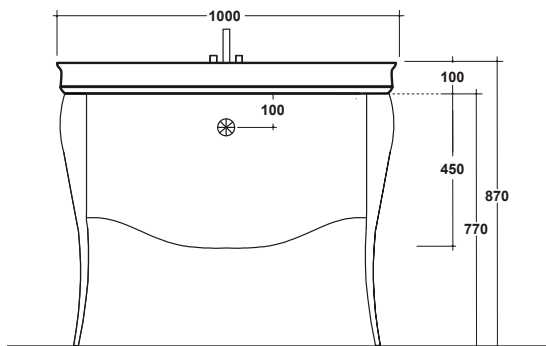

**MIS-70**

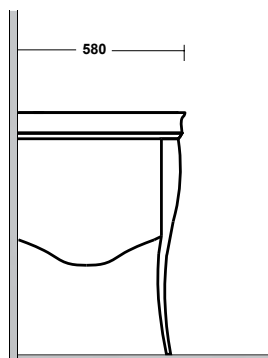

**Mobile con console cm.70 con pomello in swarovsky, cassetto con dispositivo soft closed, con kit per fissaggio al muro**  
*Cabinet with cm.70, 3-holes ceramic basin, with swarovsky knob, drawer with soft close system, including wall fixing kit*  
 Тумба с раковиной под смеситель на три отверстия с ручкой из кристалла swarovsky, выдвижной ящик с доводчиком, комплект, креплений к стене

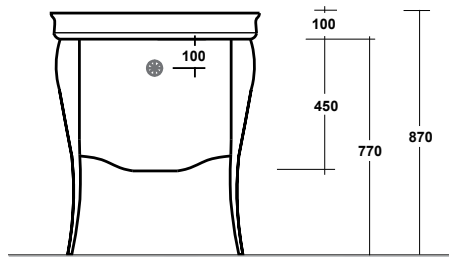



**STIS-100**

**Struttura in ottone con consolle cm.100, portasalviette e ripiano in vetro.**

*Brass made frame with console cm.100, towel rail and glass shelf.*  
*Основа из латуни с раковиной ст.100, полотенцедержателем и стеклянной полкой*

**Disponibile in finitura cromo, bronzo, oro**  
**Available in chrome, bronze or gold color.**  
**Производится в отделке хром, бронза и золото.**

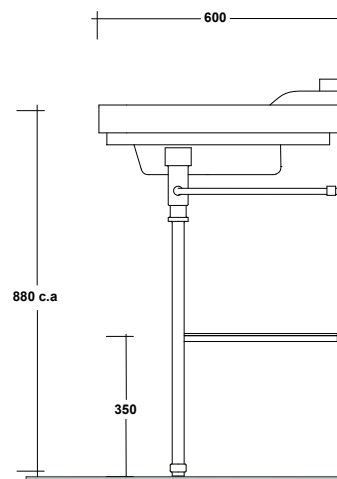
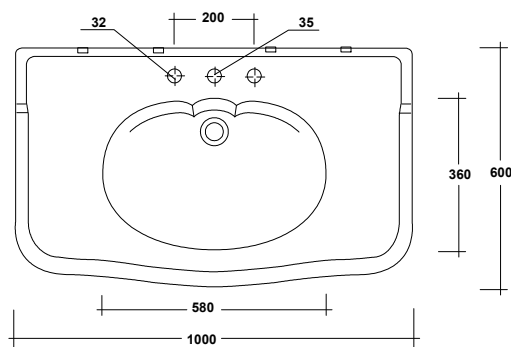

**IMP4C10301**  
**IMP4C10101**

**IMP4C10301**

**Consolle 100 cm tre fori**  
*Three holes console 100 cm*  
*Раковина 100 см, с 3 отв.*

**IMP4C10101**

**Consolle 100 cm monoforo**  
*One hole console 100 cm*  
*Раковина 100 см, с одним отв.*

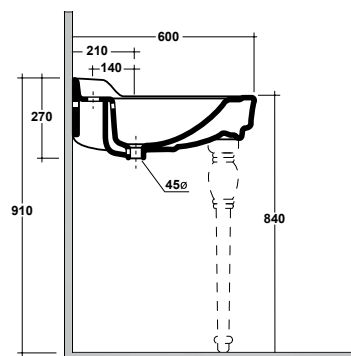
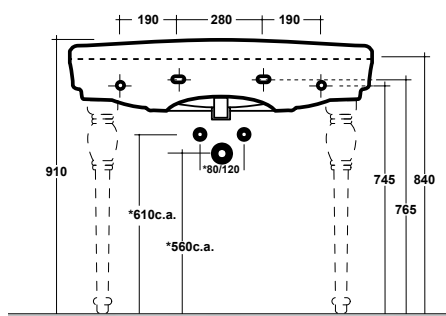
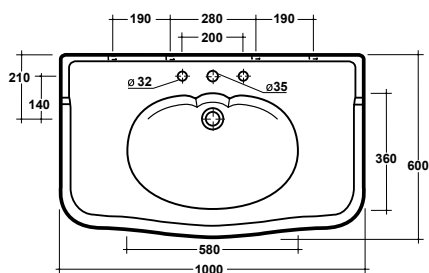

IMP9GA01

**“Coppia gambe in ceramica per consolle 100 cm”**

*Twin ceramic legs for console 100 cm*

*Пара керамических ножек для раковины-консоли на 100 см*

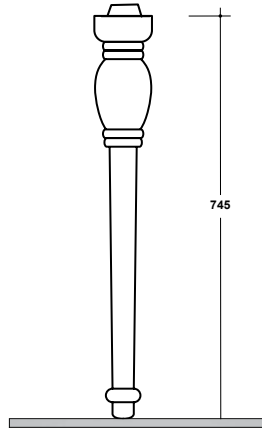

IMP4371101  
IMP4371301

IMP4371101

**Lavabo 70 cm monoforo**

*One hole wash basin 70 cm*

*Раковина 70 см с 1 отверстием под смеситель*

IMP4371301

**Lavabo 70 cm tre fori**

*Three hole wash basin 70 cm*

*Раковина 70 см с 3 отверстиями под смеситель*

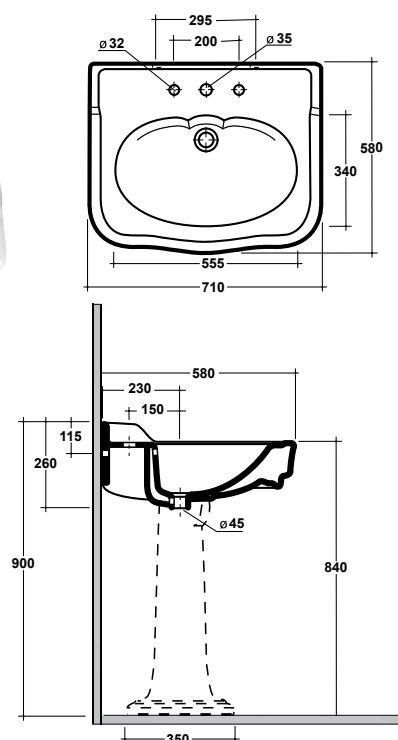

IMP9CO01

**Colonna per console & lavabi**  
*Pedestal for console & wash basins*  
Пьедестал для раковин:

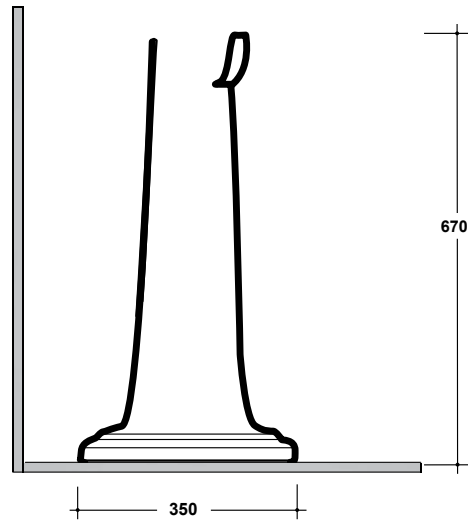

IMP4060001

**Lavabo ovale da incasso**  
*Oval under top washbasin*  
Раковина полустраиваемая

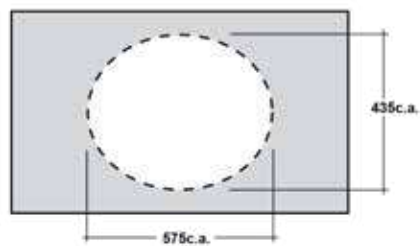
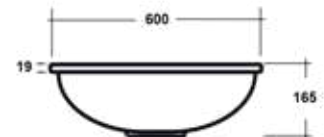
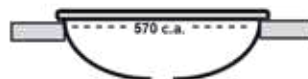
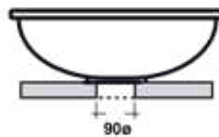
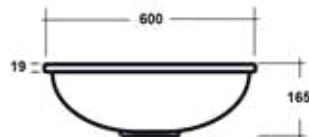

IMSP100  
IMSP100N

IMSP100

**Specchio reversibile con cornice in legno 100x70 cm**  
*Reversible mirror with wooden frame 100x70 cm*  
*Зеркало реверсивное в деревянной раме 100x70 см*

IMSP100N

**Specchio reversibile con cornice in legno 100x70 cm**  
*Reversible mirror with wooden frame 100x70 cm*  
*Зеркало реверсивное в деревянной раме 100x70 см*

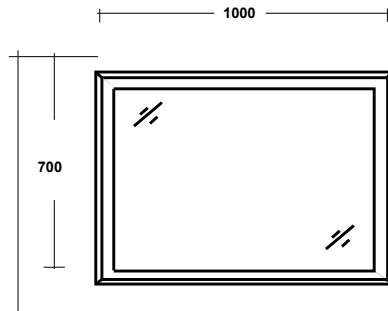

VACAIS

**WC a terra completo di fissaggi, cassetta con meccanismo a catenella e tubi di collegamento.**

*Floor mounted WC including fixing kit, high-cistern with chain and mechanism, including connection pipes.*

*Унитаз напольный, включая комплект креплений, бачок, сливной механизм, цепочку и соединительные трубы*

**Disponibile in finitura cromo, bronzo, oro**

*Available in chrome, bronze or gold color.*

**Производится в отделке хром, бронза и золото.**

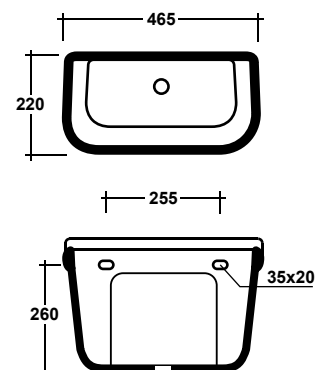
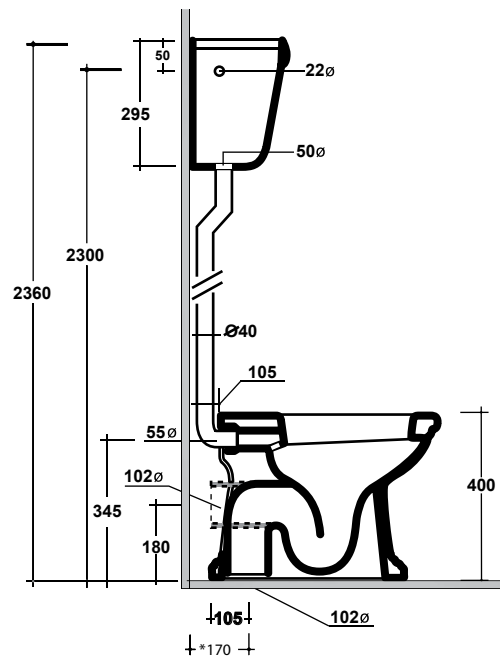
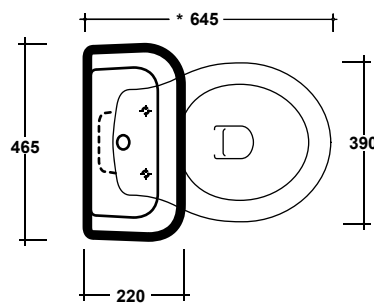

IMP130301

**Vaso monoblocco s/p + kit fissaggio**

*Wc s/p trap + fixing kit included*

*Унитаз-компакт, чаша, с комплектом креплений.*

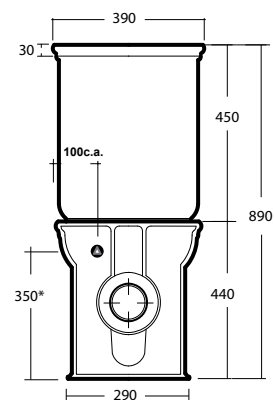
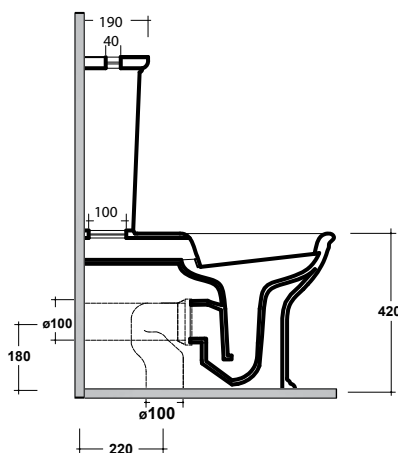
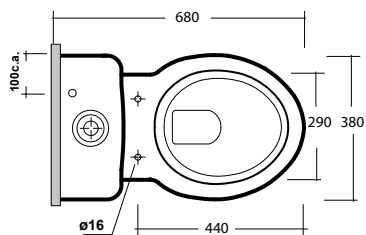

IMP110101  
IMP110201

IMP110101

**Vaso scarico a terra s + kit fissaggi**

*Wc bowl s/floor trap + fixing kit included*

*Унитаз напольный, выпуск в пол + комплект креплений.*

IMP110201

**Vaso scarico a parete p + kit fissaggi**

*Wc bowl p/wall trap + fixing kit included*

*Унитаз напольный, выпуск в стену+комплект креплений*

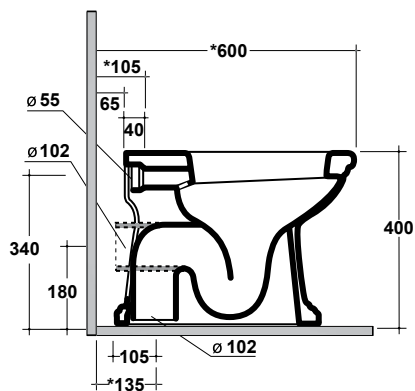
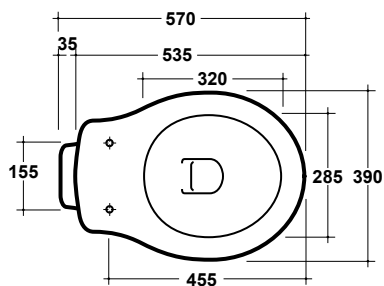

IMP120201

**Vaso sospeso + kit fissaggio**  
Wall hung wc + fixing kit  
Унитаз подвесной+комплект креплений.

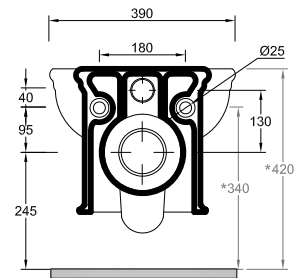
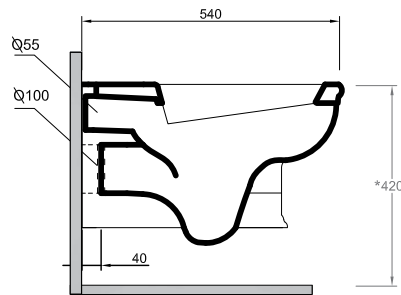
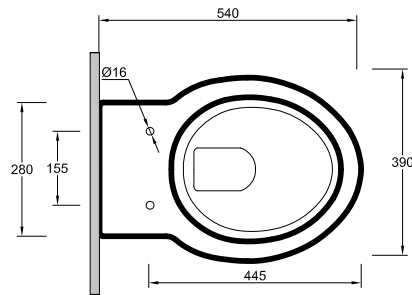

C811

**Copriwater in legno/poliestere soft close**  
Wood/polyester seat cover soft close  
Сиденья для унитаза пластик, деревянная основа, с механизмом плавного закрывания

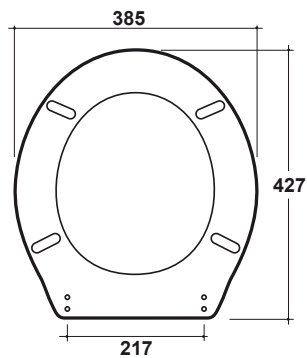

IMP220101

**Bidet sospeso monoforo**

*One hole wall hung bidet*

*Биде подвесное, 1 отверстие под смеситель+комплект креплений*

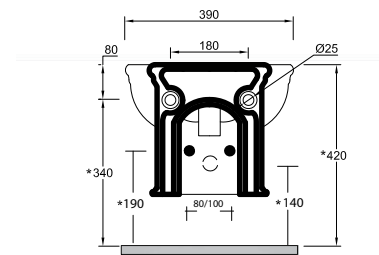
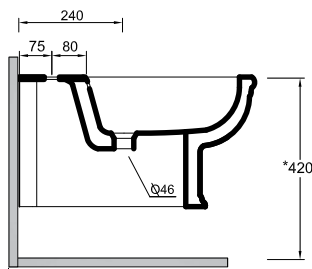
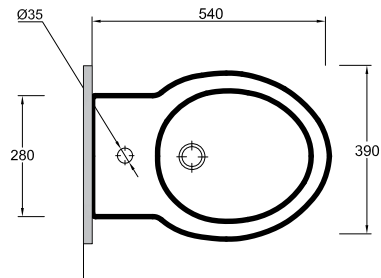

SYN4370101

**Lavabo monoforo - sospeso / appoggio / su colonna - semicolonna**

*Washbasin one hole - wall hung / over counter / on pedestal - semi pedestal*

*Раковина с 1 отв. Подвесная/ накладная/на пьедестал/на полупьедестал. С креплениями.*

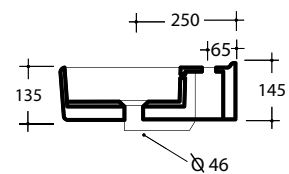
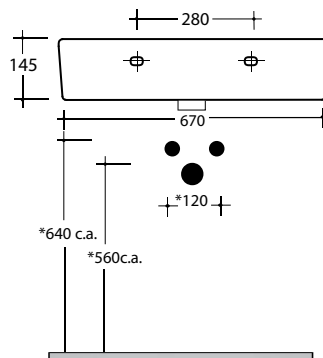
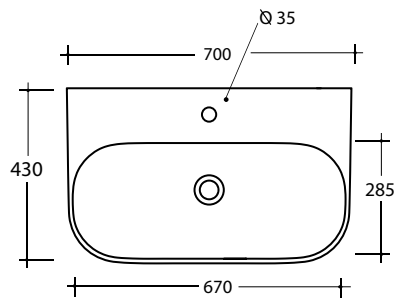

SYN9C001

**Colonna per lavabo**  
*Pedestal for washbasin*  
*Пьедестал*

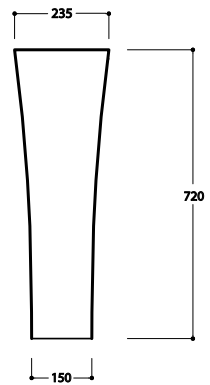
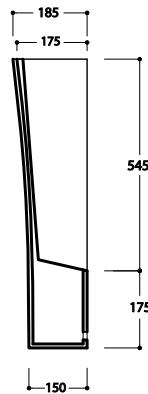
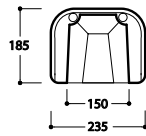

SYN120201

**Vaso sospeso**  
*Wall hung wc*  
*Унитаз подвесной*

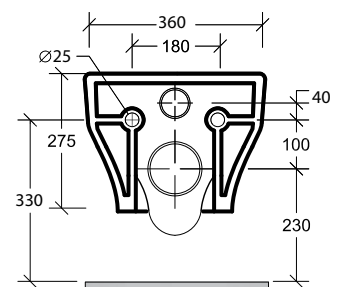
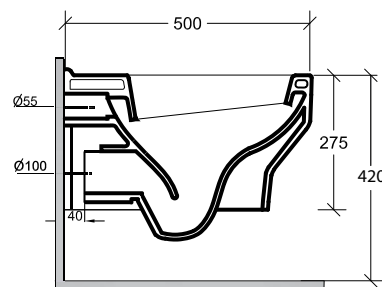
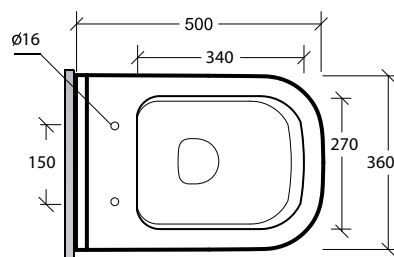



SYN220101

**Bidet sospeso monoforo**  
One hole wall hung bidet  
Биде с 1 отв. Подвесное

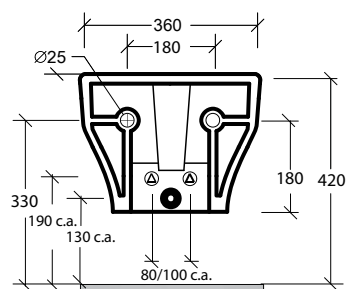
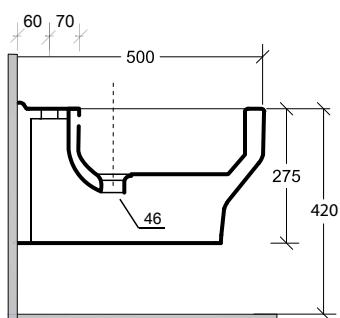
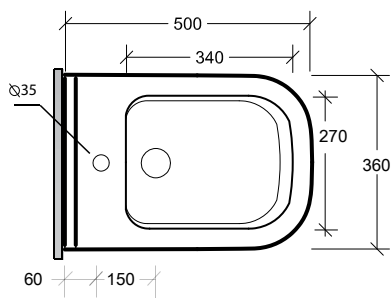

SYN110301

**Vaso s/p + kit fissaggio**  
Wc s/p trap + fixing kit included  
Унитаз напольный с комплектом креплений.

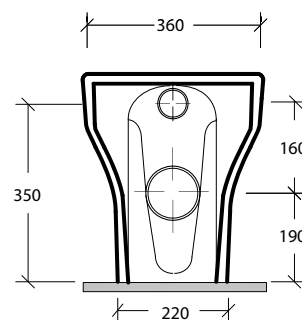
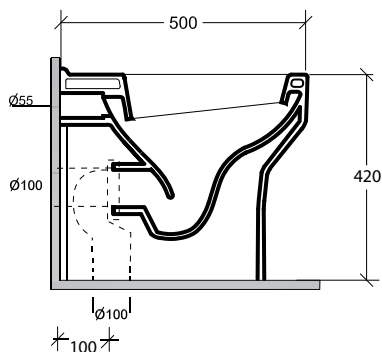
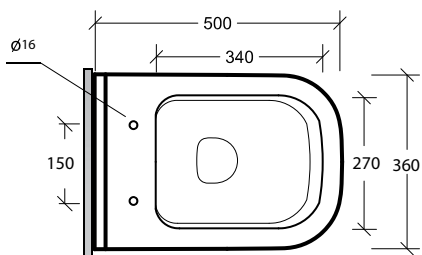

SYN230101

**Bidet monoforo + kit fissaggio**  
One hole bidet + fixing kit included  
Биде напольное с 1 отв. С креплениями

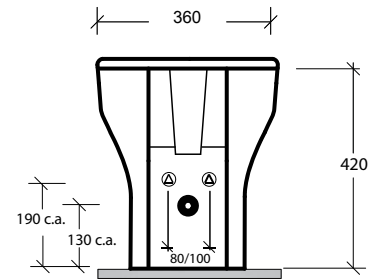
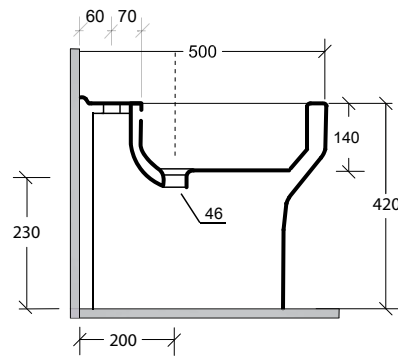
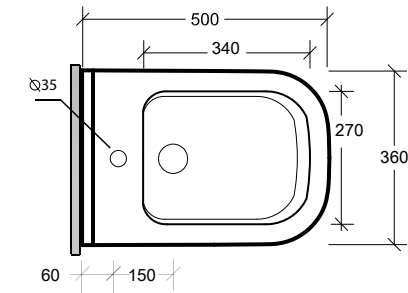

SYN130301

**Vaso monoblocco s/p + kit fissaggio**  
Wc s/p trap + fixing kit included  
Унитаз-компакт, чаша, с комплектом креплений.

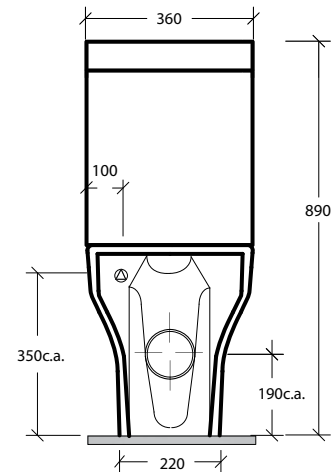
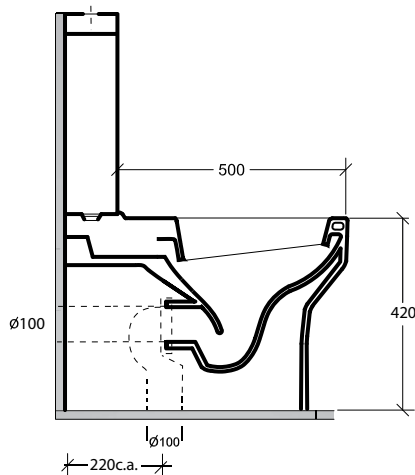
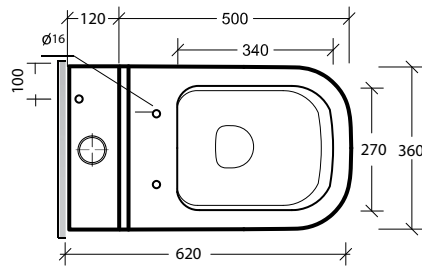

C6SYN01

**Copriwater termoindurente**  
*Thermosetting seat cover*  
Сиденье для унитаза с

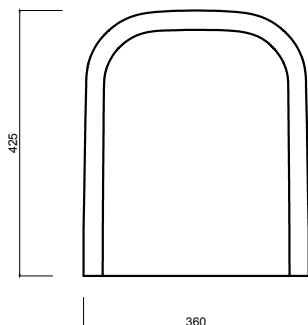



Scaldasalvietta



**GG4-482/AQ**

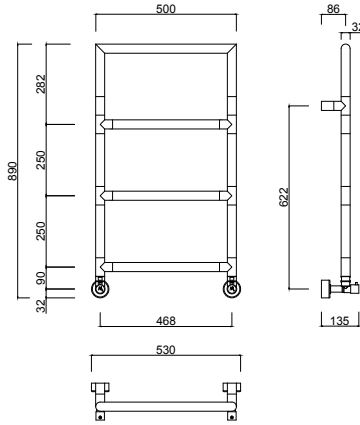

**Scaldasalviette fisso componibile, in tubo tondo Ø32 (con arco quadro)**

*Fixed modular heated towel rail in brass tube Ø32mm with squared arch.*

*Стационарный модульный полотенцесушитель из латунной трубы диаметром Ø32мм*

**GG9-416/L**

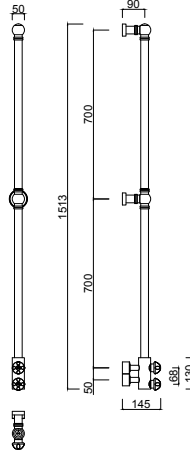

**Asta appendi accappatoio riscaldata in tubo di ottone Ø32mm**

*Heated robe hanger staff in round brass tube Ø32mm*

*Полотенцесушитель для халатов из латунной трубы диаметром Ø32 мм*

**GG9-442**

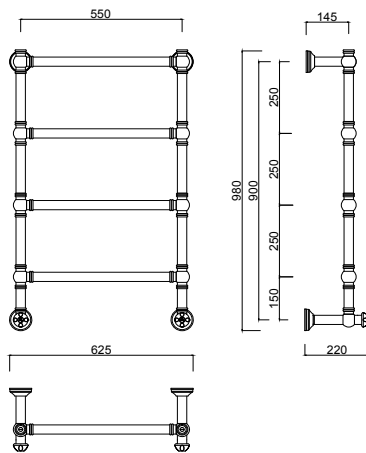

**Scaldasalviette fisso componibile, in tubo tondo Ø32mm**

*Fixed modular Ø32mm brass tube heated towel*

*Стационарный модульный полотенцесушитель из латунной трубы диаметром Ø32мм*

**GG416/L**

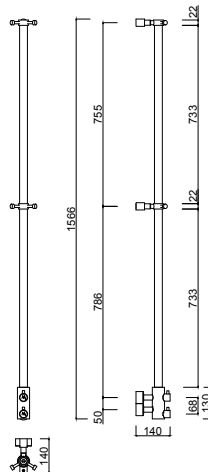

**Asta appendi accappatoio riscaldata in tubo di ottone Ø32mm**

*Heated robe hanger staff in round brass tube Ø32mm*

*Полотенцесушитель для халатов из латунной трубы диаметром Ø32 мм*

**GG442**

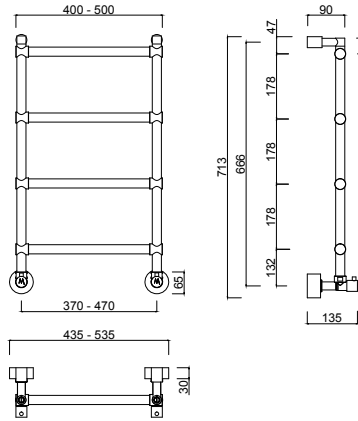

**Scaldasalviette fisso componibile in tubo di ottone Ø25mm**  
Fixed modular heated towel rail in brass tube Ø25mm  
Стационарный модульный полотенцесушитель из латунной трубы диаметром Ø25 мм

**GG442/TS**

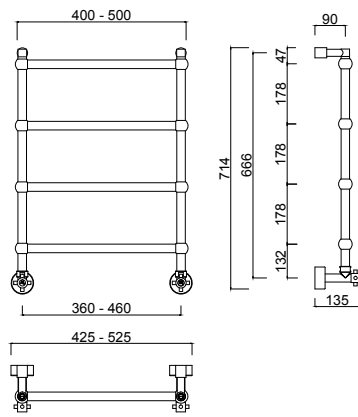
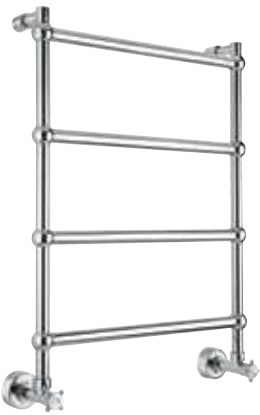

**Scaldasalviette fisso componibile in tubo di ottone Ø25mm**  
Fixed modular heated towel rail in brass tube Ø25mm  
Стационарный модульный полотенцесушитель из латунной трубы диаметром Ø25 мм

**GG616/L**

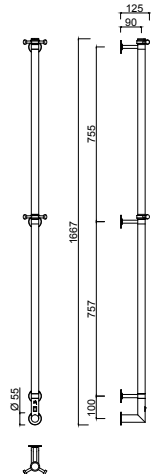

**Asta appendi accappatoio riscaldata in tubo tondo di ottone Ø32mm, con flange a muro.**  
Heated robe hanger staff in round brass tube Ø32mm, with wall flange.  
Полотенцесушитель для халатов 1650 мм из латунной трубы диаметром Ø32 мм, с пристенными креплениями

## CONDIZIONI GENERALI DI VENDITA

### ITA

Con il conferimento dell'ordine il Cliente accetta pienamente e facilmente tutte le nostre condizioni di vendita e di consegna sottofornite.

#### 1 - PREZZI

I prezzi si intendono per merce Franco nostro stabilimento di Pugno. I prezzi dei nostri listini sono soggetti a variazioni e non sono impegnativi. Ogni ordine conferito potrà essere ritenuto valido solo se da noi accettato mediante conferma d'ordine verbale o scritta.

#### 1.2 - ORDINI

Gli ordini vengono evasi salvo disponibilità ed è possibile anche la spedizione parziale. Per ordini inferiori a € 200,00 verranno addebitate € 25,00 per spese di gestione e fatturazione

#### 2 - PAGAMENTI

I termini di pagamento specifici citati in fattura si intendono tassativi; ogni variazione, che non sia stata preventivamente ed espressamente pattuita, verrà respinta. Sono liberatori solo i pagamenti delle fatture eseguiti al nostro domicilio in Pugno salvo accordi speciali di pagamento a termine. Il ritardo pagamento delle fatture darà luogo all'addebito degli interessi bancari. Al verificarsi di pagamenti non eseguiti nei termini convenuti è nostra facoltà sospendere le consegne e gli eventuali ordini già accettati. Si precisa che nessun pagamento potrà essere differito in caso di contestazione.

#### 3 - TERMINI CONSEGNA

I tempi di consegna si intendono approssimativi e non impegnativi essendo essi vincolati alle possibilità del momento. La mancata osservanza da parte nostra dei termini di consegna è conseguente a carenze di materie prime, avarie del macchinario, scioperi, serrate, interruzione o ritardi nei trasporti.

#### 4 - IMBALLAGGI

Imballaggio: gli imballi vengono fatturati al costo e non se ne accetta la restituzione; essi sono eseguiti da personale specializzato. La ditta Giulini declina comunque ogni responsabilità.

#### 5 - TRASPORTI

La merce viaggia a rischio e pericolo del committente, anche se la spedizione è effettuata in porto franco, l'Azienda declina ogni responsabilità per ritardi, guasti, avarie, rotture, ammanchi che si verifichino durante il trasporto. Spetta al committente presentare eventuali reclami al trasportatore, anche se questo è stato scelto dalla ditta Giulini. L'Azienda stessa si riserva la facoltà di addebitare al Cliente gli oneri aggiuntivi al puro costo del trasporto (es. soste, operazioni di scarico particolari, ecc.) eventualmente corrisposti al vettore.

#### 6 - RESPONSABILITÀ

Tutti i nostri articoli sono accuratamente provati e controllati. La nostra responsabilità sulla qualità del materiale si limita, previa nostra autorizzazione, ad accettare il reso, in porto franco, di pezzi riscontrati difettosi per disporre la sostituzione, senza essere tenuti a corrispondere alcun indennizzo. Non possiamo inoltre accettare alcuna responsabilità ove i materiali da noi forniti risultassero manomessi. Si esclude qualsiasi tipo di risarcimento per danni diretti o indiretti causati dalla posa in opera di materiale difettoso. È fatto assoluto divieto agli acquirenti di effettuare qualsiasi lavorazione ulteriore sui prodotti di nostra produzione. Non riceveremo merce in restituzione se non sarà da noi autorizzata. Le illustrazioni dei nostri cataloghi e depliant hanno lo scopo di dimostrare e rappresentare i singoli articoli e non costituiscono quindi obbligo di fedele esecuzione. I dettagli, le misure ed i pesi indicati sono da considerarsi approssimativi. Pertanto non ci assumiamo alcuna responsabilità in ordine a quanto sopra e conseguentemente non riconosceremo richieste per danni di qualsiasi specie.

#### 7 - RECLAMI

Non si accettano reclami dopo otto giorni dal ricevimento della merce che, trascorso tale termine si intende definitivamente accettata e regolare. Per qualsiasi contestazione è sempre solo competente il Foro di Borgomanero e Novara anche se gli ordini siano stati rimessi altrove. Non hanno alcun valore e non vengono da noi riconosciute, dichiarazioni, impegnative o garanzie di sorta assunte dai nostri dipendenti, agenti o rappresentanti, che non risultano dalle presenti condizioni generali di vendita o da atti ufficiali sottoscritti dalla Società. Riserva di proprietà - La merce consegnata rimane di riservato dominio della Fornitrice fino all'avvenuto pagamento.

#### 8 - GARANZIA

I prodotti Giulini, rigorosamente collaudati e provati prima di essere posti in vendita, sono garantiti da difetti di fabbricazione per:

- 5 anni sulla cartuccia e sui vitoni
- 2 anni per le parti di movimento meccanico
- 5 anni sulle superfici cromate, a condizione che vengano trattate correttamente
- 2 anni sulle altre superfici, a condizione che vengano trattate correttamente.
- La garanzia include:
  - Difetti di fusione. Difetti di porosità. Difetti di cromatura.
  - La riparazione o la sostituzione del pezzo riscontrato difettoso dopo la verifica da dei nostri tecnici e dietro presentazione del tagliando di controllo, a comprova della data di acquisto.
  - La garanzia decade nel caso che si riscontrino:
    - Utilizzo di acque aggressive, calcaree, non potabili o dove siano presenti corpi estranei
    - Uso di pagliette, solventi, sostanze corrosive, abrasive o aventi contenuti alcolici sulle superfici
    - Riparazioni e manutenzioni effettuate in modo non idoneo e senza preventiva autorizzazione dell'Azienda.
    - Utilizzo della rubinetteria in modo non corretto.
    - Deterioramento della rubinetteria imputabile ad installazione effettuata in modo non corretto.
    - Deterioramento delle superfici con finiture diverse da quelle cromate. La loro durata è infatti subordinata alla cura ed alla delicatezza d'uso da parte dell'utente.
    - La ditta Giulini si raccomanda vivamente di pulire superfici cromate, dorate, ottionate o colorate con acqua e sapone, utilizzando un panno morbido.

Il presente catalogo annulla e sostituisce tutti i precedenti.

## GENERAL TERMS OF SALE

### ENG

By assigning the order, the Customer fully and tacitly accepts all our terms of sale and of delivery set below.

#### 1 - PRICE

Prices are to be intended for goods returned ex-factory of Pugno. The prices of our price-lists are subject to modifications and are not binding. Each order can be considered valid only upon approval through order confirmation.

#### 1.2 PURCHASE ORDERS

Giulini has the right to proceed with full or partial shipments, depending of stock and production availability. For order of less than € 200,00 we will charge € 25,00 as handling and invoicing fees.

#### 2 - PAYMENT

The terms of payment indicated in the invoice are to be intended definite: any modification that has not been previously and precisely agreed is refused. Only the payments made at our office in Pugno are releasing except for special agreements of payment on due date. The delayed payment of the supplies will cause the debit of bank interests. When payments are not made on the agreed due date, we reserve the right to stop the deliveries and the orders already approved. It is pointed out that no payment can be deferred in case of contestation.

#### 3 - DELIVERY TERMS

The delivery terms are approximate and not binding since they depend on the goods available at the moment. Our non-observance of the delivery terms is due to lack of raw materials, machine failures, strikes, lock outs, transport interruption or delay.

#### 4 - PACKAGING

Packaging: the packages are invoiced at cost and they cannot be returned; they are carried out by qualified personnel. The Giulini firm declines all responsibility.

#### 5 - TRANSPORT

The goods travel at the buyer's own risk, even if the forwarding is carried out carriage free; the company declines all responsibility for delays, failures, breakage, shortage that occur during transport. It's up to the buyer to make complaints to the forwarder, even if the latter has been chosen by the firm Giulini. The company reserves the right to debit the Customer the additional charges at cost transport (ex. stops, unloading operations of parts, etc.) if paid to the forwarder.

#### 6 - RESPONSIBILITY

All our products are tested and controlled with accuracy. Our responsibility on the material quality is limited, by authority received, to accept returns, free of charge, of faulty parts for their replacement, without paying any damage claims. We are not responsible if the materials we provide are damaged. We exclude any compensation for direct or indirect damages caused by the installation of faulty materials. The buyers are not allowed to make further works on our products. We will not accept returns if we have not authorised them. The figures of our catalogues and leaflets intend to show and represent the articles one by one and therefore there is no obligation of exact execution. The details, the measures and the weights indicated are approximate. So we decline all responsibility for what has been mentioned above and as a result we will not acknowledge claims for any kind of damages.

#### 7 - CLAIMS

No claims are accepted after eight days from the reception of the goods. When this term has elapsed, the goods are intended regularly accepted. All the claims fall under the competence of the Court of Borgomanero and Novara even if the orders have been delivered elsewhere.

Statements, binding obligations or guarantees undertaken by our employees, agents or representatives, which do not result from these general terms of sale or from official documents undersigned by the Company, have no validity and are not acknowledged by us. Conditional sale - The delivered goods remain at the Supplier's conditional right of domain until the payment.

#### 8 - GUARANTEE

Giulini's products, strictly tested and checked before sale, are guaranteed against manufacturing defects for:

- 5 years on cartridge and head screws
- 2 years for the mechanical motion parts
- 5 years on chrome-plated surfaces, provided that they are properly treated
- 2 years on other surfaces, provided that they are properly treated

The guarantee includes:

- Casting defects. Porosity defects. Chromium plating defects.
- The repair or replacement of the faulty part after the checking of our technicians and against presentation of the contents slip, confirming the date of purchase.
- The guarantee is lost when:
  - Use of aggressive water, not drinkable, or in which foreign bodies are present
  - Use of steel wool, solvents, corrosive or abrasive substances or with alcoholic content on surfaces
  - Repairs or maintenance have been carried out in an inadequate way and without prior authorisation of the Company.
  - Wrong use of the taps and fittings.
  - Deterioration of the taps and fittings due to wrong installation.
  - Deterioration of the surfaces with finishing different from the chrome-plated ones. Their life is subject to the care and delicate utilisation on behalf of the user.
  - Deterioration of the chrome-plated surfaces due to the utilisation of cleaning products containing acids or abrasive substances; the Giulini firm recommends to clean the chrome-plated, golden, brass-plated and coloured surfaces with water and soap, by using a soft cloth.
- The guarantee cannot be renewed.

This catalogue invalidates and replaces all previous catalogues.

## CONDITIONS GENERALES DE VENTE

### F

Au moment du confèriment de l'ordre le Client s'engage à accepter tous conditions générales de vente et de livraison ci-dessous.

#### 1 - PRIX

Tous prix sont entendus pour livraison départ notre usine de Pugno. Les prix du catalogue peuvent être modifiés et il ne sont pourtant contraignant pour le vendeur. La validité des commandes adressées à Giulini Giovanni n'importe comment, est soumise à l'envoi par notre siège d'une confirmation.

#### 1.2 - COMMANDES

Les commandes sont expédiées sous réserve de disponibilité et il est également possible envoi partiel. Pour les commandes sous € 200,00 sera facturé 25,00 € pour les frais de traitement et de facturation.

#### 2 - REGLEMENT

Les dates de paiement indiquées sur la facture sont péremptoires: toutes variations de délais de paiement seront refusées par le vendeur sauf en cas d'une approbation préventive écrite de la part de la Direction de Giulini Giovanni snc.

Le paiement est entendu libératoire seulement dans le cas qu'il soit effectué chez notre usine à Pugno ou en cas d'une confirmation écrite de Giulini Tous les retards sur les paiements convenus donnent le droit au vendeur de charger au client les frais des intérêts bancaires. Le vendeur a la faculté de suspendre les expéditions ou annuler les commandes dans le cas de clients défaillants. Le client n'a pas le droit de différer le paiement n'importe quelque soit la contestation.

#### 3 - DELAIS

Les dates de livraison doivent être considérées comme indicatives et sauf au cas de force majeure. Le retard d'une livraison ne donne pas au client d'annuler la commande ou de réclamer de dédommagement.

#### 4 - EMBALLAGE

Les emballages sont vendus aux prix d'achat et aucun retour d'emballage est accepté. Les marchandises sont conditionnées et emballées par personnel spécialisé, sans aucune responsabilité par l'usine Giulini.

#### 5 - TRANSPORT

Les marchandises sont acheminées aux risques et périls du client même dans le cas des ventes Franco Lieu de destination. La responsabilité du vendeur cesse au moment où la marchandise est livré au vecteur: nous ne sommes pourtant responsables pour retards, anomalies ou manques que sont vérifiées pendant le transport. Tout réclamation devront être présentées directement au transporteur. L'usine se réserve le droit de charger au client toutes autres frais concernant le transport (arrêts, étages,...)

#### 6 - RESPONSABILITÉ

Notre responsabilité pour la qualité des produits est limité, soumise à l'envoi par notre siège d'une confirmation, à l'acceptation du retour de la marchandise, Franco notre usine. Nous ne pouvons pas accepter aucune responsabilité en cas des produits forcés. Nous n'acceptons aussi aucune demande de remboursement pour dommages provoqués de l'installations d'un produit défectueux. Les photos de nos produits sur tous catalogues, dépliant, etc... montrent les articles individuels et ne représentent pas un engagement d'exécution finale.

#### 7 - RECLAMATION

Le Client est tenu à vérifier la qualité et les conditions des matériaux au moment de la réception et nous n'acceptons aucune réclamation après 8 jours de la date de réception de la marchandise. Toutes contestations seront référées au Tribunal de Borgomanero et Novara. Les déclarations, les promesses ou les garanties des employés, des agents, ne sont pas d'engagement pour Giulini Giovanni snc. Réserve de propriété La marchandise consigné est pas encore réglé reste de propriété du vendeur.

#### 8 - GARANTIE

les produits GIULINI sont rigoureusement vérifiés avant de sortir l'usine, et ils sont garantis pour les couvertures suivantes:

- 5 ans pour la cartouche et les fêtes céramiques
- 2 ans pour les pièces de mouvement mécanique
- 5 ans pour les surfaces chromées à conditions qu'elles soient traitées correctement.
- 2 ans pour les surfaces colorées à conditions qu'elles soient traitées correctement.

La Garantie comprend:

- défaut de fusion, défaut de porosité, défaut de chromage
- Le dépannage et la substitution du pièce résulté defectueux depuis la vérifi e et la présentation du Voucher de Garantie comprovant la date d'achat.
- La Garantie n'a aucun valeur en cas de:
  - emploi d'eau non-potable, calcaire, agressive ou en présence de corps étrangers
  - emploi de substances abrasives, détergents et savons pour le nettoyage et/ou contenant alcool
- Dépannages effectués sans autorisation de l'usine ou par personnel non qualifié.
- Mauvaise installation des produits
- Mauvaise utilisation de la robinetterie
- Détériorement des surfaces teintées (non chrome). Leur durée est subordonnée à une utilisation et nettoyage très attentifs.
- Giulini conseille de nettoyer le robinets seulement avec de l'eau, du savon et un chiffon moelleux

Le catalogue présent annule et il remplace tous les précédents.



## ALLGEMEINE VERKAUFSBEDINGUNGEN

### D

Aufträge und getroffene Vereinbarungen bedürfen zur Rechtswirksamkeit unserer schriftlichen Bestätigung.

#### 1 - PREISE

Die Preise, Daten, Masse, Charakteristiken , Artikel, die in Katalogen, Prospekten, Listen, Rundschreiben angeführt sind, sind unverbindlich und können , ohne Benachrichtigung, jederzeit abgeändert werden. Für eine Verbindlichkeit, benötigen sie unsere ausdrückliche Bestätigung.

#### 1.2 - BESTELLUNGEN

Giulini ha das Recht, mit Voll-oder Teillieferungen vor, je nach Lager und Verfügbarkeit in der Produktion. Bei Bestellung von weniger als 200,00 € werden wir 25,00 € als Handhabung und Abrechnung zu verrechnen.

#### 2 - ZAHLUNG

Alle Zahlungen müssen an unserem Firmensitz, wenn nicht anders vereinbart, erfolgen. Dies gilt auch bei Zahlung mit Tratten oder anderen Zahlungsformen. Im Falle einer Ratenzahlung, wird bei nicht einhalten des Zahlungstermins der gesamte Restbetrag sofort fällig. Dieser Betrag wird mit Verzugszinsen und Geldabwertungs-Ausgleich ISTAT der Lebenssteuerung, gemäss dem Index von der Handelskammer NOVARA belastet. Eventuelle Streitfragen unterliegen dem Italienischen Gesetz. Das einzig zuständige Gericht ist das Amtsgericht in Verbania.

#### 3 - LIEFERUNGEN

Die angegebene Lieferzeit in unseren Angeboten oder Bestätigungen ist nicht verbindlich, sie kann sich durch außerordentlichen Vorkommnissen, hervorgerufen durch höherer Gewalt, wie Brand, Überschwemmung, Streik, usw. verschieben.

#### 4 - VERPACKUNG

Die Verpackungskosten gehen zur Last des Kunden. Sie werden zum Selbstkostenpreis in Rechnung gestellt. Eine Rücknahme der Verpackung erfolgt nicht. Beanstandungen und Schadenersatzforderungen müssen an den Transporteur gestellt werden, da unsere Verpackungen immer ordnungsgemäß ausgeführt werden und somit GIULINI keine Haftung übernimmt.

#### 5 - TRANSPORT

Sind keine anderweitigen Vereinbarungen getroffen worden, erfolgt die Lieferung ab unserem Werk. Transportkosten und -Risiken gehen zu Lasten des Kunden. Von uns aus, wenn nicht ausdrücklich gewünscht, wird keine Transportversicherung abgeschlossen. Wird die vom Kunden gewünschte Versicherung von uns abgeschlossen, werden die Unkosten in Rechnung gestellt.

#### 6 / 7 - MÄNGEL UND REKLAMATION

Unsere Produkte unterliegen einer strengen Qualitätskontrolle und haben eine Garantiezeit von 5 (fünf) Jahren ab Verkaufsdatum. Die Garantie beinhaltet den Austausch der defekten Teile, welche vorab an uns zurückgeschickt werden müssen. Eventuelle zusätzliche Schadenforderungen sind ausgeschlossen. Technische Mängel sowie Qualitätsmängel müssen uns schriftlich innerhalb von 8 (acht) Tagen nach Erhalt der Ware mitgeteilt werden. Nach Überprüfung der Ware wird diese, wenn berechtigt, durch eine Ersatzlieferung ersetzt. GIULINI haftet nur für Mängel und Defekte, welche bei sachgemäßen Einsatz und Handhabung der Ware auftreten. Für entstandenen Schaden durch unsachgemäßer Montage oder Benutzung, lehnen wir jegliche Verantwortung ab. Rücksendung von Ware darf nur nach vorheriger Vereinbarung erfolgen.

#### 8 - GARANTIEBEDINGUNGEN

Alle GIULINI Produkte unterliegen einer strengen Qualitätskontrolle. Auf die nachfolgend genannten Bauteile gewährt die Fa. GIULINI wie folgt Garantie:

- 5 Jahre Garantie auf Gussfehler oder Risse im Messinggrundkörper;
- 5 Jahre Garantie auf fehlerhafte Kartuschen oder Keramik Oberteile;
- 5 Jahre Garantie auf fehlerhafte Verchromungen des Grundkörpers;
- 2 Jahre fuer alle andere Oberflaeche. Eine Garantieleistung für noch nicht verbaute oder installierter Produkte kann nur dann erbracht werden, wenn der fehlerhafte Artikel in der Originalverpackung und einer dazu gehörigen Rechnung an die Fa GIULINI eingesandt wird. Eine Garantieleistung kann NICHT erfolgen wenn Fehler in Erscheinung treten, die auf nachfolgende Punkte zurückzuführen sind:  
Nichtbefolgen der Betriebs- bzw. der Montageanleitung, die jedem Produkt der Fa. GIULINI beiliegt; bei nicht ordnungsgemäßer oder den allgemeinen Installationsrichtlinien entsprechenden Installation des Produktes,d.h.Schäden, die nachweislich durch:  
- eine fehlerhafte Montage  
- falsche Installation  
- falsche Wartung, unsachgemäßer Gebrauch entstanden sind;  
• Schäden, die durch Transport oder Sturz verursacht wurden;  
• Schäden, die durch allgemeinen Verschleiß verursacht wurden;  
• Schäden, die durch eine nicht sachgemäße Wartung oder Reparatur entstanden sind, da diese nicht von der Fa. GIULINI autorisiertes Personal durchgeführt wurden, sowie die Verwendung von nicht original Ersatzteilen u-Bauteilen der Fa. GIULINI;  
• Schäden, die durch Frost oder Fremdkörper in und an dem Produkt entstanden sind (Zuleitungen oder Rohrleitungen müssen vor in Betriebnahme der Armatur oder des GIULINI Produktes nach den allgemeinen Installations-Richtlinien gespült werden);  
• Schäden, die durch die unsachgemäße Reinigung unter Verwendung von ätzenden , säurehaltigen, scheuernden und alkoholhaltigen Reinigern zurück zu führen sind; dies gilt auch für Holz- oder Acrylharz-Bauteile an GIULINI Produkte.  
• Eine Garantieleistung beinhaltet die Reparatur oder den kostenlosen Ersatz der defekten Bauteile, welche im Vorfeld durch autorisiertes Fachpersonal der Fa. GIULINI geprüft wurde. Hierzu ist unbedingt erforderlich, dass die Rechnung des Produkts dem fehlerhaften Bauteil beigefügt wird.

Der anwesende Katalog annulliert und es ersetzt alle Präzedenzfälle.

## CONDICIONES GENERALES DE VENTA

### ES

Con el envío del pedido el cliente acepta totalmente e implícitamente todas nuestras condiciones de venta y de entrega indicadas aquí abajo.

#### 1 - PRECIOS

Los precios se entienden para mercancía entregada franco nuestro establecimiento de Pagnò. Los precios de nuestras listas de precios pueden variar y no son vinculantes. Cada pedido enviado podrá considerarse válido sólo si lo aceptamos por medio de confirmación de pedido.

#### 1.2 - PEDIDOS

Los pedidos se envían sujetos a disponibilidad y es posible también el envío parcial. Para pedidos de menos de € 200,00 se cobrará € 25,00 por gastos de procesamiento y facturación.

#### 2 - PAGOS

Los términos de pago especificados en la factura se entienden perentorios: cada variación que no haya sido previamente y explícitamente concordada será rechazada. Sólo los pagos de las facturas efectuados en nuestro domicilio en Pagnò son liberatorios, salvo acuerdos especiales de pago a plazo. El pago retardado de los suministros causará la imputación de intereses bancarios. En el caso de pagos no efectuados en los términos concordados tenemos la facultad de interrumpir las entregas y los eventuales pedidos ya aceptados. Precisamos que ningún pago se podrá retardar en caso de reclamación.

#### 3 - TÉRMINOS DE ENTREGA

Los tiempos de entrega se entienden aproximativos y no vinculantes porque dependen de las posibilidades del momento. La falta de cumplimiento de los términos de entrega por parte nuestra es consecuencia de falta de materias primas, averías de la maquinaria, huelgas, cierres, interrupción o retrasos de los transportes.

#### 4 - EMBALAJES

Embalaje; los embalajes se facturan a precio de coste y no se acepta su restitución; se efectúan por personal especializado. La empresa Giulini en cualquier caso se considera exenta de cualquier responsabilidad.

#### 5 - TRANSPORTES

La mercancía viaja a cuenta y riesgo del comprador, aunque la expedición se efectúe franco de porte, la Compañía se considera exenta de cualquier responsabilidad por retrasos, fallos, averías, rupturas, faltas que se verifícaran durante el transporte. El comprador tiene que presentar sus reclamaciones al transportador, aunque éste haya sido escogido por la empresa Giulini. La Compañía misma se reserva la facultad de imputar al cliente los costes adicionales al precio de coste del transporte (ej. estadías, operaciones de descarga particulares, etc.) eventualmente pagados al agente de transporte.

#### 6 - RESPONSABILIDAD

Todos nuestros artículos son probados y controlados cuidadosamente. Nuestra responsabilidad respecto a la calidad del material se limita, previa nuestra autorización, a aceptar la restitución, franco de porte, de piezas que sean defectuosas para disponer su sustitución, sin deber pagar ninguna indemnización. Además no podemos aceptar ninguna responsabilidad si los materiales que suministramos resultaran manumediados. Cualquier tipo de indemnización por daños directos o indirectos causados por la puesta en obra de material defectuoso está excluida. Está absolutamente prohibido a los compradores efectuar cualquier trabajo ulterior a los productos de nuestra producción. No recibiremos mercancía restituída si no será autorizada por nosotros. Las ilustraciones de nuestros catálogos y folletos tienen el fin de demostrar y representar los artículos y luego no constituyen obligación de fi el ejecución. Los detalles, las medidas y los pesos indicados se deben considerar aproximativos. Por lo tanto no tenemos ninguna responsabilidad por lo que concierne lo indicado arriba y por consecuencia no aceptaremos solicitudes por daños de cualquier tipo.

#### 7 - RECLAMACIÓN

No se aceptan reclamaciones después de ocho días desde el recibo de la mercancía que, transcurrido este término, se entiende definitivamente aceptada y regular. Para cualquier contestación es siempre competente el tribunal de Borgomanero y Novara aunque los pedidos hayan sido enviados a otro lugar. No tienen ningún valor y no reconocemos declaraciones, declaraciones de empeño o garantías de cualquier tipo, que nuestros dependientes, agentes o representantes suscriban, que no resulten en las presentes condiciones generales de venta o en actas oficialmente suscritos por la Compañía. Reserva de propiedad - La mercancía entregada permanece en el dominio reservado de la empresa suministradora hasta que el pago haya sido efectuado.

#### 8 - GARANTIE

Los productos Giulini, rigurosamente ensayados y examinados antes de su venta están garantizados en caso de defectos de fabricación por:  
5 años para cartucho y monturas  
2 años para las partes con movimiento mecánico  
5 años para las superficies cromadas, puesto que hayan sido tratadas correctamente  
2 años para las demás superficies, puesto que hayan sido tratadas correctamente  
La garantía incluye:  
• Defectos de fundición. Defectos de porosidad. Defectos de cromado.  
• La reparación o la sustitución de la pieza dañada después de la comprobación de nuestros técnicos y mediante presentación del talón de control para comprobar la fecha de compra.  
La garantía pierde validez en el caso de que se averigüen:  
• Utilización de aguas agresivas, calcáreas, no potables o donde se encuentren cuerpos extraños  
• Empleo de esponjas abrasivas o metálicas, solventes, sustancias corrosivas, abrasivas o con contenido de alcohol sobre las superficies  
• Reparaciones y mantenimientos efectuados de modo no idóneo y sin autorización previa de la Empresa.  
• Uso de la grifería de manera incorrecta.  
• Deterioro de la grifería imputable a instalación efectuada de manera incorrecta.  
• Deterioro de las superficies cromadas con acabados diferentes de los cromados. En efecto su duración depende del cuidado y de la delicadeza del uso por parte del usuario.  
• Deterioro de las superficies cromadas debido al uso de productos para la limpieza conteniendo ácidos o sustancias abrasivas; por lo tanto la empresa Giulini recomienda encarecidamente limpiar las superficies cromadas, doradas, bronceadas o coloreadas con agua y jabón, utilizando un trapo suave.  
La garantía no es renovable.

El presente catálogo anula y sustituye todos los precedentes.

## ОБЩИЕ УСЛОВИЯ ПРОДАЖИ

### R

При подаче заказа Клиент полностью и беспрекословно соглашается на все условия продажи и поставки Компании, перечисленные дальше.

#### 1 - ЦЕНЫ

Указанные цены являются ценами франко на нашем предприятии в Поньо. Цены, указанные в наших прайс-листах могут подлежать изменению и не являются обязательными. Оформленный заказ может считаться действительным только при условии, что был нами подтвержден.

#### 1.2 - ЗАКАЗЫ

Заказ может считаться действительным только при условии, что был принят нами путем подтверждения заказа (в том числе вербального подтверждения) Заказы выполняются при условии наличия, возможна частичная поставка товара К заказам, стоимость которых не превышает € 200,00, добавляется дополнительная плата € 25,00 за расходы на фактурирование

#### 2 - ОПЛАТА

Сроки оплаты, указанные в фактуре, считаются категориескими: какое-либо изменение, если оно не было предварительно оговорено, принято не будет. Освобождаются от обязательств исключительно оплаты фактур, выпущенных для места, где расположена наша Компания, т.е.г.Поньо,если это предусмотрено особыми договоренностями. Несвоевременная оплата поставок приводит к оплате штрафа в виде банковского процента. В случае обнаружения невыполненных своевременно оплат, мы имеем право на прекращение поставок и выполнения уже принятых заказов. Спешим уточнить, что ни одна оплата не сможет быть проделана в случае оспаривания.

#### 3 - СРОКИ ПОСТАВКИ

Сроки поставки являются приблизительными и необязательными, учитывая то обстоятельство, что они зависят от актуальных возможностей. Несоблюдение сроков с нашей стороны является следствием непредвиденных нехватки сырья, поломки аппаратуры, забастовок, локаутов, задержек перевозки.

#### 4 - УПАКОВКА

Упаковка фактурируется к стоимости и не подлежит возврату; упаковка товара выполняется высокоспециализированным персоналом.

#### 5 - ТРАНСПОРТИРОВКА

Перевозка товара осуществляется на страх и риск заказчика, хоть отправка происходит с самого предприятия, Компания не берет на себя ответственность за задержки, поломки, нехватки, если принятой тары стали условия перевозки. Потенциальные оспаривания заказов должен предьявлять компания-перевозчику, даже если последние выданы компанией Giulini. Сама компания оставляет за собой право не учитывать дополнительных расходов к стоимости перевозки (напр., простой, особые операции погрузки и т.п.), в случае если таковые предусмотрены перевозчиком.

#### 6 - ОТВЕТСТВЕННОСТЬ

Вся продукция подлежит тщательному контролю и всевозможным функциональным испытаниям. Наша ответственность за качество материала ограничивается приемом возврата в поро-франко, единицы товара, которая была определена как бракованная с последующей ее заменой. Возмещение убытков не предусмотрено. Кроме того, мы не берем на себя ответственность за поставленные нами товары, которые были вскрыты. Мы исключаем кокую-либо компенсацию за прямой и непрямой ущерб в следствии введения в эксплуатацию кокого-либо бракованного товара. Покупателю запрещено выполнять кокую-либо дополнительную обработку на товарах нашего производства. Товар подлежащий возврату не будет нами принят без предварительного но до разрешения с нашей стороны. Иллюстрации в наших каталогах и брошюрах призваны показать отдельные артикулы и, потому, их точное выполнение не является обязательным. Указанные характеристики, размеры и вес являются приблизительными. Следовательно, мы не берем на себя ответственность касательно вышеуказанного и не сможем принять пререкания по поводу такого рода брака.

#### 7 - ОСПАРИВАНИЕ

Не принимаются оспаривания по истечению восьми дней после получения товара (по истечению данного срока товар считается принятым). Компетентным органом касательно кокого-либо оспаривания является Суд Боргоманеро и Новары. Кокого-либо рода заявления, обязательства или гарантии предоставленные нашими подчиненными, агентами или представителями не имеют никакой юридической ценности и нами не признаются, если непредьявлены Общими условиями продажи или актами, официально подписанными нашим Обществом. Оставление за собой права собственности - Поставленный товар является собственностью Поставщика до момента его оплаты.

#### 8 - ГАРАНТИЯ

Продукция Giulini подвергается всем необходимым функциональным испытаниям прежде чем поступить в продажу и имеет производственную гарантию:

- 5 лет на картриджи и винты
  - 2 года на части, подвергающиеся механическому воздействию
  - 5 лет на хромированные поверхности, при условии что их использование является корректным
  - 2 года на другие поверхности, при условии, что их использование является корректным
- Гарантия включает в себя:
- Дефекты отделки. Дефекты пористости. Дефекты хромирования.
  - Починку или замену бракованной единицы после технического осмотра при предъявлении талона прохождения технического контроля и документа о приобретении с указанием даты такого.
- Гарантия не распространяется в случае:
- Использования жесткой, известняковой, непригодной для питья или содержащей иородные тела воды
  - Использования металлических стружки, растворителей, едких абразивов или содержащих спирт веществ при очистке
  - Ремонта или ухода за продукцией несоответствующим образом и без предварительного но до разрешения со стороны Компании
  - Некорректного использования продукции
  - Износа продукции в следствии ее использования некорректным образом
  - Износа поверхностей отличных от хромированных. Их долговечность зависит от ухода и деликатности использования их пользователем
- Компания Giulini настоятельно рекомендует чистить хромированные, позолоченные, латунированные или цветные поверхности при помощи воды и мыла, используя для этой цели мягкую тряпку.

Данный каталог аннулирует и заменяет все предыдущие.

**AGENTE DI ZONA / AGENT OF ZONE**

Name/Surname .....

Mobile .....

E-mail .....





Rubinetteria Giulini Giovanni srl  
Via Salvo D'Acquisto, 22  
28076 Pogno (No) Italy  
Tel. +39 0322 97157 / Fax. +39 032297498  
Tel. Export +39 0322 97057  
[www.giulini.it](http://www.giulini.it)  
[info@giulini.it](mailto:info@giulini.it)