



BATH COLLECTION



S

PA

WP

SS

FUZION®

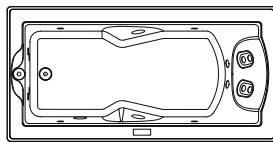

FUZION® 7236 WHIRLPOOL

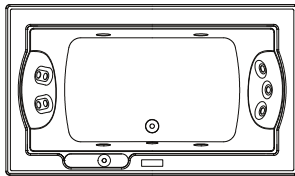

FUZION® 7242 WHIRLPOOL

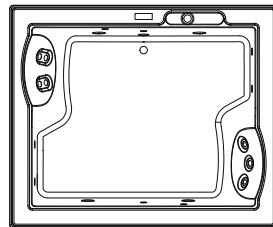

FUZION® 7260 WHIRLPOOL

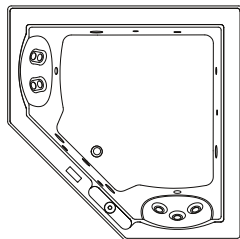

FUZION® 6666 CORNER WHIRLPOOL

DROP-IN OR UNDERMOUNT

7236 • 71" L X 35" W X 24" H*

7242 • 72" L X 42" W X 24" H*

7260 • 72" L X 60" W X 24" H*

7260 • 72" L X 60" W X 24" H DUAL ZONE*

6666 • 66" L X 66" W X 24" H*

*Height with wood frame is 25.25"

Dramatic in any setting, the true beauty of the FUZION® comes from experiencing authentic Jacuzzi® hydrotherapy. Just one example: with a total of 23 jets in the Dual Zone Whirlpool Fuzion®, the two of you can each personalize your own unique hydromassage. The future of hydrotherapy is here.

Choose from Teak, Wenge or no-stain wood finishes for frames (select models). You can also find plans for custom decks at www.jacuzzi.com. Please see page 52 for details.

BATHTUB FILLERS

The Jacuzzi® Era™ Bathtub Fillers and Accessories collection features superior design in popular installation types and finishes.



ERA™ FLOOR-MOUNTED STYLE

ERA™ FREESTANDING BATHTUB FILLERS: WALL-MOUNTED OR FLOOR-MOUNTED STYLES

AVAILABLE FINISHES

CHROME
BRUSHED NICKEL
BRIGHT BRASS

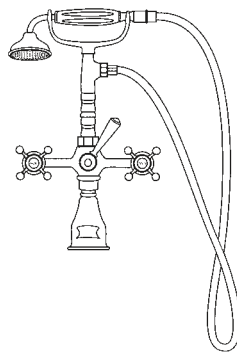

ERA™ WALL-MOUNTED

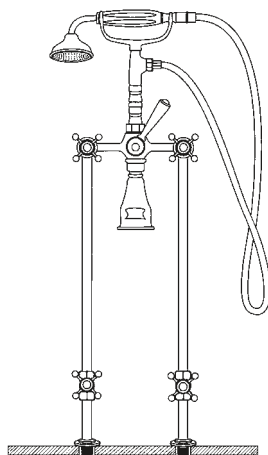

ERA™ WITH SUPPLY LINES

ERA™ TUB FILLERS

- Hand shower and cradle
- Wide-mouth spout
- Cross handles
- White ceramic details
- Flexible stainless steel hose
- For use with the Era™ and other bathtubs

ACCESSORIES

Freestanding bathtub supply lines with shutoffs (for floor-mount installations).

Era™ Freestanding bathtub toe-tap drain kit (if used on Era™ Slipper 6934, the Era™ Slipper Overflow Gasket Kit is required).

OPTIONS & ACCESSORIES

BATH SKIRTS

Get a customized look without the hassle and expense of building a surround or deck for your new Jacuzzi® bathtub. Baths with integral skirts are shown, or choose from skirting options, available on select models and sizes.



HAND RAILS

Feel more secure getting in and out of the bath. Sets of two handrails are available in Chrome, Brushed Nickel and Oil-Rubbed Bronze.



ELARA® PURE AIR® BATH

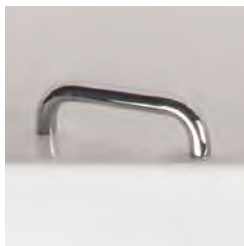

FRAMES & LEGS



FUZION® BATHTUB
WOOD FRAMES



ERA™ DOUBLE-ENDED BATHTUB
WOOD FRAME WITH LEGS



ERA™ DOUBLE-ENDED BATHTUB
WHITE PEDESTAL BASE



ERA™ DOUBLE-ENDED BATHTUB
BALL & CLAW FEET



ERA™ SLIPPER BATHTUB
BALL & CLAW FEET



ACCESSORIES (continued)

PILLOWS

Pillows support your head and neck for added comfort in the bath.



SMALL CURVED
NECK PILLOW
4" X 9"

CURVED PILLOW
6" X 15"
STRAIGHT PILLOW
5" X 15"

STRAIGHT PILLOW
7.5" X 21"

FUZION®
REPLACEMENT
PILLOW
5.2" X 20"

JET RING TRIM KITS

Enhance the look of your bath with a simple change.



Want to add some extra elegance to your bathtub? TargetPro™ jets, older TheraPro™ jets, and AccuPro™ jets can be upgraded post-installation with metal finish jet trim rings – available in Chrome, Brushed Nickel and Oil-Rubbed Bronze.



WHITE



CHROME



BRUSHED NICKEL



OIL-RUBBED BRONZE

TILE FLANGE KIT

Use to help customize the tile around the bath in an alcove installation.

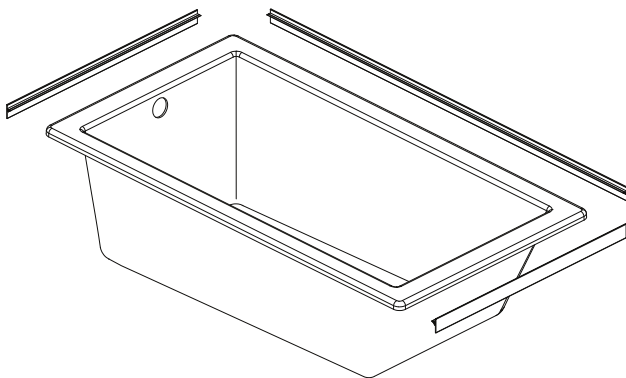

Note: While Elara® and Linea® bathtubs can be ordered with metallic trim finishes factory-installed, all other bathtub families come with acrylic-matched TargetPro™ jet trim rings. TargetPro™ jets with Illumatherapy™ lighting come standard with acrylic-matched trim rings.

DRAINS & DRAIN KITS

Available in Chrome, Brushed Nickel and Oil-Rubbed Bronze.

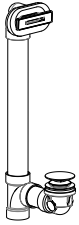

LINEAR OVERFLOW DRAIN KIT

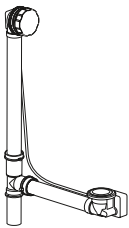

UNIVERSAL ROTARY/CABLE DRAIN KIT,
26" CABLE

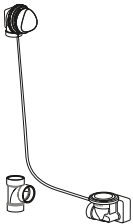

ROTARY DRAIN PVC DRAIN KIT, 26" CABLE
(Does not include waste and overflow pipes)

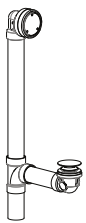

UNIVERSAL DEEP SOAK DRAIN KIT
(Only compatible with Soaking bathtubs
without electronic controls)



ERA™ FREESTANDING TOE-TAP DRAIN KIT
(Requires purchase of GV11 Gasket kit if used
on Era™ Slipper 6934)



TOE-TAP DRAIN FOR VERONA®, TORINO™
AND URBINO™ SOLID SURFACE BATHTUBS
(Brushed Nickel and Oil-Rubbed Bronze drains
must be bought at time of bath purchase)

RAPIDHEAT™ INLINE HEATER

Use on compatible Jacuzzi® Whirlpool tubs to keep bathwater warm as you take your time relaxing.



JACUZZI® SYSTEMS CLEAN™

The two-part cleaner and deodorizer for all whirlpool bath plumbing systems.

- Minimizes residue build-up
- Fast-acting, deep cleaning power
- Breathes new life into whirlpool baths



FINISHES/OPTIONS



FUZION® WITH WENGE FRAME

OPTIONAL
WOOD FRAME



TEAK



WENGE



FUZION® WHIRLPOOL SHOWN WITH
OPTIONAL WOOD FRAME

Choose from Teak, Wenge or no-stain wood finishes for frames (select models). CAD drawings for custom decks, for use by your design professional, can be downloaded at www.jacuzziLuxurybath.com.



UNFINISHED
STAIN TO MATCH
YOUR BATHROOM



FUZION®
WITH CUSTOM-
MADE SOLID
SURFACE DECK

SOLID SURFACES

Luxecast™ Solid Surface is durable, stain-resistant and easy to clean. Every product is factory-tested to meet UL and IAPMO standards. Proudly cast in the USA. Finish options are available on Torino™, Urbino™, and Verona® baths.



GLOSS



WHITE



GLOSS INSIDE / MATTE OUTSIDE



OYSTER



MATTE



BLACK



MATTE INSIDE / GLOSS OUTSIDE



BLACK / WHITE

VERONA®

BRAVO™

QUALITY CONSTRUCTION

Stronger and more durable than gelcoat fiberglass, the high-gloss acrylic sheet on our baths is reinforced with a proprietary fiberglass/resin formula.

FINISHING TOUCHES

Details that complement your bathroom's decor add subtle style. Three options, including Chrome, are available in the Linear Overflow Drain cover and drain.



CHROME

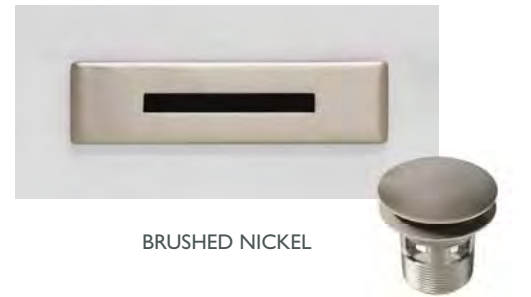

BRUSHED NICKEL



OIL-RUBBED BRONZE









































JACUZZI® BATH COLLECTION

COMPARE FEATURES

- Standard Features
- Upgrades

Note: All models available as a Soaking bath

| | ALLUSION® 6636 | ALLUSION® 7236 | ALLUSION® 7242 | AMIGA® 7236 | BELLAVISTA™ 6042 | BELLAVISTA™ 6642 | BELLAVISTA™ 7242 | BELLAVISTA™ 6060 | BIANCA™ 6636 | BRAVO™ 6636 | CAPELLA® 5555 | CAPELLA® 6060 | CELESTE™ 7032 | CETRA® 6032 | CETRA® 6036 | DUETTA® 6042 | DUETTA® 6636 | DUETTA® 6642 | DUETTA® 7242 | |
|------------------------------------|----------------|----------------|----------------|-------------|------------------|------------------|------------------|------------------|--------------|-------------|---------------|---------------|---------------|-------------|-------------|--------------|--------------|--------------|--------------|--|
| SPECIFICATIONS | | | | | | | | | | | | | | | | | | | | |
| Exterior Length (inches) | 66 | 72 | 72 | 72 | 60 | 66 | 72 | 60 | 66 | 66 | 55 | 60 | 70 | 60 | 60 | 60 | 66 | 66 | 72 | |
| Exterior Width (inches) | 36 | 36 | 42 | 36 | 42 | 42 | 42 | 60 | 36 | 36 | 55 | 60 | 32 | 32 | 36 | 42 | 36 | 42 | 42 | |
| Shape | | | | | | | | | | | | | | | | | | | | |
| Bathers | | | | | | | | | | | | | | | | | | | | |
| Max Gallons | 75 | 83 | 95 | 78 | 78 | 88 | 95 | 92 | 89 | 60 | 72 | 84 | 67 | 62 | 67 | 83 | 79 | 97 | 108 | |
| Drain Location | Center | Center | Center | End | Center | Center | Center | Center | End | Center | Center | Center | Center | End | End | Center | Center | Center | Center | |
| FEATURES | | | | | | | | | | | | | | | | | | | | |
| Tru-Level® Base or Adjustable Feet | ● | ● | ● | ● | ● | ● | ● | ● | ● | ● | ● | ● | ● | ● | ● | ● | ● | ● | ● | |
| Slip-Resistant Bottom | ● | ● | ● | ● | ● | ● | ● | ● | ● | ● | ● | ● | ● | ● | ● | ● | ● | ● | ● | |
| Armrest | | | | ● | ● | ● | ● | ● | | | ○ | | | ● | ● | | | | | |
| Handrail | | | | | | | | | | | | | | | | | | | | |
| SALON® SPA | | | | | | | | | | | | | | | | | | | | |
| Heated Blower | 900w | 900w | 900w | | 900w | 900w | 900w | 900w | | | | | | | | 900w | 900w | 900w | 900w | |
| Total Jets | 10 | 10 | 10 | | 10 | 10 | 10 | 10 | | | | | | | | 16 | 16 | 16 | 16 | |
| Bottom Air Injectors | ● | ● | ● | | ● | ● | ● | ● | | | | | | | | ● | ● | ● | ● | |
| Chromatherapy Lighting | ● | ● | ● | | ● | ● | ● | ● | | | | | | | | ● | ● | ● | ● | |
| Illumatherapy™ Jet Lighting | ○ | ○ | ○ | | ○ | ○ | ○ | ○ | | | | | | | | ○ | ○ | ○ | ○ | |
| Auto-Dri™ (drain activated) | ● | ● | ● | | ● | ● | ● | ● | | | | | | | | ● | ● | ● | ● | |
| Wave Mode | ● | ● | ● | | ● | ● | ● | ● | | | | | | | | ● | ● | ● | ● | |
| RapidHeat™ Inline Heater | ● | ● | ● | | ● | ● | ● | ● | | | | | | | | ● | ● | ● | ● | |
| Whisper Technology™ | ○ | ○ | ○ | | ○ | ○ | ○ | ○ | | | | | | | | ○ | ○ | ○ | ○ | |
| J5 LCD Control | ○ | ○ | ○ | | ○ | ○ | ○ | ○ | | | | | | | | ○ | ○ | ○ | ○ | |
| WHIRLPOOL | | | | | | | | | | | | | | | | | | | | |
| Total Jets | 10 | 10 | 10 | 8 | 10 | 10 | 10 | 10 | | | 8 | 8 | | 8 | 8 | 16 | 16 | 16 | 16 | |
| TargetPro™ Jets | 4 | 4 | 4 | 4 | 4 | 4 | 4 | 4 | | | 4 | 4 | | 4 | 4 | 4 | 4 | 4 | 4 | |
| SlimPro® Jets | | | | | | | | | | | | | | | | | | | | |
| AccuPro™ Jets | 6 | 6 | 6 | 4 | 2 | 2 | 2 | 3 | | | 4 | 4 | | 4 | 4 | 12 | 12 | 12 | 12 | |
| Rotating Neck Jets | | | | | 4 | 4 | 4 | 3 | | | | | | | | | | | | |
| Chromatherapy Lighting | ● | ● | ● | ○ | ● | ● | ● | ● | | | ○ | ○ | | ○ | ○ | ● | ● | ● | ● | |
| Illumatherapy™ Jet Lighting | ○ | ○ | ○ | | ○ | ○ | ○ | ○ | | | | | | | | ○ | ○ | ○ | ○ | |
| Wave Mode | ● | ● | ● | | ● | ● | ● | ● | | | | | | | | ● | ● | ● | ● | |
| RapidHeat™ Inline Heater | ● | ● | ● | ○ | ● | ● | ● | ● | | | ○ | ○ | | ○ | ○ | ● | ● | ● | ● | |
| Whisper Technology™ | ○ | ○ | ○ | | ○ | ○ | ○ | ○ | | | | | | | | ○ | ○ | ○ | ○ | |
| J5 LCD Control | ○ | ○ | ○ | | ○ | ○ | ○ | ○ | | | | | | | | ○ | ○ | ○ | ○ | |
| PURE AIR® BATH | | | | | | | | | | | | | | | | | | | | |
| Heated Blower | 800w | 800w | 800w | 800w | 800w | 800w | 800w | 800w | | 800w | 800w | 800w | | 800w | 800w | 800w | 800w | 800w | 800w | |
| Bottom Air Injectors | ● | ● | ● | | ● | ● | ● | ● | | | | | | | | ● | ● | ● | ● | |
| Side Air Injectors | ● | ● | ● | ● | ● | ● | ● | ● | | ● | ● | ● | | ● | ● | ● | ● | ● | ● | |
| Chromatherapy Lighting | ● | ● | ● | | ● | ● | ● | ● | | | | | | | | ● | ● | ● | ● | |
| Auto-Dri™ (drain activated) | ● | ● | ● | | ● | ● | ● | ● | | | | | | | | ● | ● | ● | ● | |
| Auto-Dri™ (time activated) | | | | ● | | | | | | | | | | | | | | | | |
| TLC Thermal Lumbar Comfort™ | ● | ● | ● | ● | ● | ● | ● | ● | | ● | ● | ● | | ● | ● | ● | ● | ● | ● | |
| Wave Mode | ● | ● | ● | | ● | ● | ● | ● | | | | | | | | ● | ● | ● | ● | |
| J5 LCD Control | ○ | ○ | ○ | | ○ | ○ | ○ | ○ | | | | | | | | ○ | ○ | ○ | ○ | |
| INSTALLATION OPTIONS | | | | | | | | | | | | | | | | | | | | |
| Freestanding | | | | | | | | | ● | ● | | | ● | | | | | | | |
| Undermount | | | | | | | | | | | | | | | | ● | ● | ● | ● | |
| Drop-in | ● | ● | ● | ● | ● | ● | ● | ● | | ● | ● | ● | | ● | ● | ● | ● | ● | ● | |
| Alcove | | | | ○ | | | | | | | ○ | ○ | | ○ | ○ | | | | | |
| Optional Skirt Available | | | | ● | | | | | | | | | | | | | | | | |
| Integral Skirt | | | | ○ | | | | | | | ○ | ○ | | ○ | ○ | | | | | |
| Tile Flange | | | | ○ | | | | | | | ○ | ○ | | ○ | ○ | | | | | |
| PAGE NUMBER | 16 | 16 | 16 | 17 | 18 | 18 | 18 | 18 | 19 | 20 | 21 | 21 | 22 | 23 | 23 | 24 | 24 | 24 | 24 | |

| MITO™ 6042 | MITO™ 7242 | NOVA™ 6036 | NOVA™ 6042 | NOVA™ 7236 | NOVA™ 7242 | REAL™ 7242 | RIVA® 6243 | RIVA® 6638 | RIVA® 7242 | SIA® 6636 | SIA® 7242 | SIENA™ 6934 | SIGNA® 6042 | SIGNA® 7242 | STELLA™ 6731 | TARA™ 6060 | TORINO™ 6236 | URBINO™ 5633 | VERONA® 7133 | | |
|--|---|---|---|---|---|---|---|---|---|---|---|---|---|---|---|---|---|---|---|------------------------------------|--|
| | | | | | | | | | | | | | | | | | | | | SPECIFICATIONS | |
| 60 | 72 | 60 | 60 | 72 | 72 | 72 | 62 | 66 | 72 | 66 | 72 | 69 | 60 | 72 | 67 | 60 | 62 | 56 | 71 | Exterior Length (inches) | |
| 42 | 42 | 36 | 42 | 36 | 42 | 42 | 43 | 38 | 42 | 36 | 42 | 34 | 42 | 42 | 31 | 60 | 36 | 33 | 33 | Exterior Width (inches) | |
|  |  |  |  |  |  |  |  |  |  |  |  |  |  |  |  |  |  |  |  | Shape | |
|  |  |  |  |  |  |  |  |  |  |  |  |  |  |  |  |  |  |  |  | Bathers | |
| 73 | 95 | 48 | 54 | 56 | 89 | 95 | 54 | 56 | 89 | 76 | 102 | 90 | 75 | 90 | 67 | 79 | 86 | 74 | 70 | Max Gallons | |
| Center | Center | End | End | End | End | Center | End | End | End | Center | Center | Center | Center | Center | End | Center | Center | End | Center | Drain Location | |
| | | | | | | | | | | | | | | | | | | | | FEATURES | |
| <input checked="" type="checkbox"/> | <input checked="" type="checkbox"/> | <input checked="" type="checkbox"/> | <input checked="" type="checkbox"/> | <input checked="" type="checkbox"/> | <input checked="" type="checkbox"/> | <input checked="" type="checkbox"/> | <input checked="" type="checkbox"/> | <input checked="" type="checkbox"/> | <input checked="" type="checkbox"/> | <input checked="" type="checkbox"/> | <input checked="" type="checkbox"/> | <input checked="" type="checkbox"/> | <input checked="" type="checkbox"/> | <input checked="" type="checkbox"/> | <input checked="" type="checkbox"/> | <input checked="" type="checkbox"/> | <input checked="" type="checkbox"/> | <input checked="" type="checkbox"/> | <input checked="" type="checkbox"/> | Tru-Level® Base or Adjustable Feet | |
| <input checked="" type="checkbox"/> | <input checked="" type="checkbox"/> | <input checked="" type="checkbox"/> | <input checked="" type="checkbox"/> | <input checked="" type="checkbox"/> | <input checked="" type="checkbox"/> | <input checked="" type="checkbox"/> | <input checked="" type="checkbox"/> | <input checked="" type="checkbox"/> | <input checked="" type="checkbox"/> | <input checked="" type="checkbox"/> | <input checked="" type="checkbox"/> | <input checked="" type="checkbox"/> | <input checked="" type="checkbox"/> | <input checked="" type="checkbox"/> | <input checked="" type="checkbox"/> | <input checked="" type="checkbox"/> | <input checked="" type="checkbox"/> | <input checked="" type="checkbox"/> | <input checked="" type="checkbox"/> | Slip-Resistant Bottom | |
| <input checked="" type="checkbox"/> | <input checked="" type="checkbox"/> | <input checked="" type="checkbox"/> | <input checked="" type="checkbox"/> | <input checked="" type="checkbox"/> | <input checked="" type="checkbox"/> | <input checked="" type="checkbox"/> | <input checked="" type="checkbox"/> | <input checked="" type="checkbox"/> | <input checked="" type="checkbox"/> | <input checked="" type="checkbox"/> | <input checked="" type="checkbox"/> | <input checked="" type="checkbox"/> | <input checked="" type="checkbox"/> | <input checked="" type="checkbox"/> | <input checked="" type="checkbox"/> | <input checked="" type="checkbox"/> | <input checked="" type="checkbox"/> | <input checked="" type="checkbox"/> | <input checked="" type="checkbox"/> | Armrest | |
| <input checked="" type="checkbox"/> | <input checked="" type="checkbox"/> | <input checked="" type="checkbox"/> | <input checked="" type="checkbox"/> | <input checked="" type="checkbox"/> | <input checked="" type="checkbox"/> | <input checked="" type="checkbox"/> | <input checked="" type="checkbox"/> | <input checked="" type="checkbox"/> | <input checked="" type="checkbox"/> | <input checked="" type="checkbox"/> | <input checked="" type="checkbox"/> | <input checked="" type="checkbox"/> | <input checked="" type="checkbox"/> | <input checked="" type="checkbox"/> | <input checked="" type="checkbox"/> | <input checked="" type="checkbox"/> | <input checked="" type="checkbox"/> | <input checked="" type="checkbox"/> | <input checked="" type="checkbox"/> | Handrail | |
| | | | | | | | | | | | | | | | | | | | | SALON® SPA | |
| | | | | | | 900w | | | | 900w | 900w | | | | | | | | | Heated Blower | |
| | | | | | | 10 | | | | 13 | 13 | | | | | | | | | Total Jets | |
| | | | | | | <input checked="" type="checkbox"/> | | | | <input checked="" type="checkbox"/> | <input checked="" type="checkbox"/> | | | | | | | | | Bottom Air Injectors | |
| | | | | | | <input checked="" type="checkbox"/> | | | | <input checked="" type="checkbox"/> | <input checked="" type="checkbox"/> | | | | | | | | | Chromatherapy Lighting | |
| | | | | | | <input checked="" type="checkbox"/> | | | | <input checked="" type="checkbox"/> | <input checked="" type="checkbox"/> | | | | | | | | | Illumatherapy™ Jet Lighting | |
| | | | | | | <input checked="" type="checkbox"/> | | | | <input checked="" type="checkbox"/> | <input checked="" type="checkbox"/> | | | | | | | | | Auto-Dri™ (drain activated) | |
| | | | | | | <input checked="" type="checkbox"/> | | | | <input checked="" type="checkbox"/> | <input checked="" type="checkbox"/> | | | | | | | | | Wave Mode | |
| | | | | | | <input checked="" type="checkbox"/> | | | | <input checked="" type="checkbox"/> | <input checked="" type="checkbox"/> | | | | | | | | | RapidHeat™ Inline Heater | |
| | | | | | | <input checked="" type="checkbox"/> | | | | <input checked="" type="checkbox"/> | <input checked="" type="checkbox"/> | | | | | | | | | Whisper Technology™ | |
| | | | | | | <input checked="" type="checkbox"/> | | | | <input checked="" type="checkbox"/> | <input checked="" type="checkbox"/> | | | | | | | | | J5 LCD Control | |
| | | | | | | | | | | | | | | | | | | | | WHIRLPOOL | |
| 8 | 8 | 8 | 8 | 8 | 8 | 10 | 8 | 8 | 8 | 13 | 13 | | 8 | 8 | | | | | | Total Jets | |
| 4 | 4 | 4 | 4 | 4 | 4 | 4 | 4 | 4 | 4 | 4 | 4 | | 4 | 4 | | | | | | TargetPro™ Jets | |
| | | | | | | | | | | | | | | | | | | | | SlimPro® Jets | |
| 4 | 4 | 4 | 4 | 4 | 4 | 2 | 4 | 4 | 4 | 9 | 9 | | 4 | 4 | | | | | | AccuPro™ Jets | |
| | | | | | | 4 | | | | | | | | | | | | | | Rotating Neck Jets | |
| <input checked="" type="checkbox"/> | <input checked="" type="checkbox"/> | <input checked="" type="checkbox"/> | <input checked="" type="checkbox"/> | <input checked="" type="checkbox"/> | <input checked="" type="checkbox"/> | <input checked="" type="checkbox"/> | <input checked="" type="checkbox"/> | <input checked="" type="checkbox"/> | <input checked="" type="checkbox"/> | <input checked="" type="checkbox"/> | <input checked="" type="checkbox"/> | | <input checked="" type="checkbox"/> | <input checked="" type="checkbox"/> | | | | | | Chromatherapy Lighting | |
| | | | | | | <input checked="" type="checkbox"/> | | | | <input checked="" type="checkbox"/> | <input checked="" type="checkbox"/> | | | | | | | | | Illumatherapy™ Jet Lighting | |
| | | | | | | <input checked="" type="checkbox"/> | | | | <input checked="" type="checkbox"/> | <input checked="" type="checkbox"/> | | | | | | | | | Wave Mode | |
| <input checked="" type="checkbox"/> | <input checked="" type="checkbox"/> | <input checked="" type="checkbox"/> | <input checked="" type="checkbox"/> | <input checked="" type="checkbox"/> | <input checked="" type="checkbox"/> | <input checked="" type="checkbox"/> | <input checked="" type="checkbox"/> | <input checked="" type="checkbox"/> | <input checked="" type="checkbox"/> | <input checked="" type="checkbox"/> | <input checked="" type="checkbox"/> | | <input checked="" type="checkbox"/> | <input checked="" type="checkbox"/> | | | | | | RapidHeat™ Inline Heater | |
| | | | | | | <input checked="" type="checkbox"/> | | | | <input checked="" type="checkbox"/> | <input checked="" type="checkbox"/> | | | | | | | | | Whisper Technology™ | |
| | | | | | | <input checked="" type="checkbox"/> | | | | <input checked="" type="checkbox"/> | <input checked="" type="checkbox"/> | | | | | | | | | J5 LCD Control | |
| | | | | | | | | | | | | | | | | | | | | PURE AIR® BATH | |
| 800w | 800w | 800w | 800w | 800w | 800w | 800w | 800w | 800w | 800w | 800w | 800w | | 800w | 800w | | | | | | Heated Blower | |
| <input checked="" type="checkbox"/> | <input checked="" type="checkbox"/> | <input checked="" type="checkbox"/> | <input checked="" type="checkbox"/> | <input checked="" type="checkbox"/> | <input checked="" type="checkbox"/> | <input checked="" type="checkbox"/> | <input checked="" type="checkbox"/> | <input checked="" type="checkbox"/> | <input checked="" type="checkbox"/> | <input checked="" type="checkbox"/> | <input checked="" type="checkbox"/> | | <input checked="" type="checkbox"/> | <input checked="" type="checkbox"/> | | | | | | Bottom Air Injectors | |
| | | | | | | <input checked="" type="checkbox"/> | | | | <input checked="" type="checkbox"/> | <input checked="" type="checkbox"/> | | <input checked="" type="checkbox"/> | <input checked="" type="checkbox"/> | | | | | | Side Air Injectors | |
| | | | | | | <input checked="" type="checkbox"/> | | | | <input checked="" type="checkbox"/> | <input checked="" type="checkbox"/> | | <input checked="" type="checkbox"/> | <input checked="" type="checkbox"/> | | | | | | Chromatherapy Lighting | |
| | | | | | | <input checked="" type="checkbox"/> | | | | <input checked="" type="checkbox"/> | <input checked="" type="checkbox"/> | | <input checked="" type="checkbox"/> | <input checked="" type="checkbox"/> | | | | | | Auto-Dri™ (drain activated) | |
| | | | | | | <input checked="" type="checkbox"/> | | | | <input checked="" type="checkbox"/> | <input checked="" type="checkbox"/> | | <input checked="" type="checkbox"/> | <input checked="" type="checkbox"/> | | | | | | Auto-Dri™ (time activated) | |
| | | | | | | <input checked="" type="checkbox"/> | | | | <input checked="" type="checkbox"/> | <input checked="" type="checkbox"/> | | <input checked="" type="checkbox"/> | <input checked="" type="checkbox"/> | | | | | | TLC Thermal Lumbar Comfort™ | |
| | | | | | | <input checked="" type="checkbox"/> | | | | <input checked="" type="checkbox"/> | <input checked="" type="checkbox"/> | | <input checked="" type="checkbox"/> | <input checked="" type="checkbox"/> | | | | | | Wave Mode | |
| | | | | | | <input checked="" type="checkbox"/> | | | | <input checked="" type="checkbox"/> | <input checked="" type="checkbox"/> | | <input checked="" type="checkbox"/> | <input checked="" type="checkbox"/> | | | | | | J5 LCD Control | |
| | | | | | | | | | | | | | | | | | | | | INSTALLATION OPTIONS | |
| | | | | | | | | | | | | <input checked="" type="checkbox"/> | | | <input checked="" type="checkbox"/> | | <input checked="" type="checkbox"/> | <input checked="" type="checkbox"/> | <input checked="" type="checkbox"/> | Freestanding | |
| <input checked="" type="checkbox"/> | <input checked="" type="checkbox"/> | <input checked="" type="checkbox"/> | <input checked="" type="checkbox"/> | <input checked="" type="checkbox"/> | <input checked="" type="checkbox"/> | <input checked="" type="checkbox"/> | <input checked="" type="checkbox"/> | <input checked="" type="checkbox"/> | <input checked="" type="checkbox"/> | <input checked="" type="checkbox"/> | <input checked="" type="checkbox"/> | | <input checked="" type="checkbox"/> | <input checked="" type="checkbox"/> | | <input checked="" type="checkbox"/> | <input checked="" type="checkbox"/> | <input checked="" type="checkbox"/> | <input checked="" type="checkbox"/> | Undermount | |
| | | <input checked="" type="checkbox"/> | <input checked="" type="checkbox"/> | <input checked="" type="checkbox"/> | <input checked="" type="checkbox"/> | <input checked="" type="checkbox"/> | <input checked="" type="checkbox"/> | <input checked="" type="checkbox"/> | <input checked="" type="checkbox"/> | <input checked="" type="checkbox"/> | <input checked="" type="checkbox"/> | | <input checked="" type="checkbox"/> | <input checked="" type="checkbox"/> | | <input checked="" type="checkbox"/> | <input checked="" type="checkbox"/> | <input checked="" type="checkbox"/> | <input checked="" type="checkbox"/> | Drop-in | |
| | | <input checked="" type="checkbox"/> | <input checked="" type="checkbox"/> | <input checked="" type="checkbox"/> | <input checked="" type="checkbox"/> | <input checked="" type="checkbox"/> | <input checked="" type="checkbox"/> | <input checked="" type="checkbox"/> | <input checked="" type="checkbox"/> | <input checked="" type="checkbox"/> | <input checked="" type="checkbox"/> | | <input checked="" type="checkbox"/> | <input checked="" type="checkbox"/> | | <input checked="" type="checkbox"/> | <input checked="" type="checkbox"/> | <input checked="" type="checkbox"/> | <input checked="" type="checkbox"/> | Alcove | |
| | | <input checked="" type="checkbox"/> | <input checked="" type="checkbox"/> | <input checked="" type="checkbox"/> | <input checked="" type="checkbox"/> | <input checked="" type="checkbox"/> | <input checked="" type="checkbox"/> | <input checked="" type="checkbox"/> | <input checked="" type="checkbox"/> | <input checked="" type="checkbox"/> | <input checked="" type="checkbox"/> | | <input checked="" type="checkbox"/> | <input checked="" type="checkbox"/> | | <input checked="" type="checkbox"/> | <input checked="" type="checkbox"/> | <input checked="" type="checkbox"/> | <input checked="" type="checkbox"/> | Optional Skirt Available | |
| | | <input checked="" type="checkbox"/> | <input checked="" type="checkbox"/> | <input checked="" type="checkbox"/> | <input checked="" type="checkbox"/> | <input checked="" type="checkbox"/> | <input checked="" type="checkbox"/> | <input checked="" type="checkbox"/> | <input checked="" type="checkbox"/> | <input checked="" type="checkbox"/> | <input checked="" type="checkbox"/> | | <input checked="" type="checkbox"/> | <input checked="" type="checkbox"/> | | <input checked="" type="checkbox"/> | <input checked="" type="checkbox"/> | <input checked="" type="checkbox"/> | <input checked="" type="checkbox"/> | Integral Skirt | |
| | | <input checked="" type="checkbox"/> | <input checked="" type="checkbox"/> | <input checked="" type="checkbox"/> | <input checked="" type="checkbox"/> | <input checked="" type="checkbox"/> | <input checked="" type="checkbox"/> | <input checked="" type="checkbox"/> | <input checked="" type="checkbox"/> | <input checked="" type="checkbox"/> | <input checked="" type="checkbox"/> | | <input checked="" type="checkbox"/> | <input checked="" type="checkbox"/> | | <input checked="" type="checkbox"/> | <input checked="" type="checkbox"/> | <input checked="" type="checkbox"/> | <input checked="" type="checkbox"/> | Tile Flange | |
| 34 | 34 | 35 | 35 | 35 | 35 | 36 | 37 | 37 | 37 | 38 | 38 | 39 | 40 | 40 | 41 | 42 | 43 | 44 | 45 | PAGE NUMBER | |

JACUZZI® BRAND

Jacuzzi Group Worldwide is a global organization with original product patents and thousands of employees. Valvasone, Italy, the Jacuzzi family's home of origin, is a key center of this worldwide network. Jacuzzi Luxury Bath is headquartered near Los Angeles in Chino Hills, California.

Globally known for luxury, Jacuzzi® Brand zealously researches science and technology advances to design and develop beautiful products for contemporary lifestyles. Since 1956, when Candido Jacuzzi commercialized the first at-home hydrotherapy pump, every product made by Jacuzzi has been created for the same reason: to provide a rejuvenating and refreshing hydrotherapeutic experience that revitalizes both body and spirit.

60
YEARS
OF HYDROTHERAPY



WARRANTY

Jacuzzi® baths are backed by one of the most comprehensive warranties in the industry and a nationwide service network. Jacuzzi Luxury Bath's Limited Lifetime Warranty is assurance that your investment will perform reliably for years to come.

13925 CITY CENTER DR., SUITE 200
CHINO HILLS, CA 91709 / U.S.A.
(800) 288-4002

www.jacuzziluxurybath.com

© 2015 Jacuzzi Inc. All rights reserved. Jacuzzi® is a registered trademark of Jacuzzi Inc. All other brands, product names, company names, trade names and trademarks used are the property of their respective owners. Jacuzzi may add to, change or remove any part of these materials at any time, without notice. Reproduction in whole or in part without written permission is prohibited. International products may be configured differently to meet local electrical requirements. Dimensions are approximate.



WATER THAT MOVES YOU™