

NEXT

Series available with  KOLO coating

Half-round corner shower enclosure 80 x 80 cm* and 90 x 90 cm*, wing door. Opening to the outside.

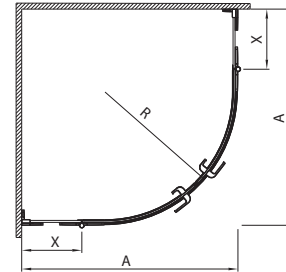
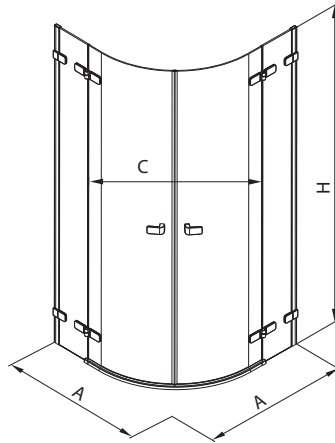

	X	R
HKPF80	191.5	450
HKPF90	241.5	550

Article No.	Description		A Adjustment range [mm]*	C Entrance width [mm]	H Height [mm]	Weight kg	Number of pcs. per pallet
	Glass type	Hinges/profile colour					
HKPF80222003	transparent glass	○ chrome / silver glossy	770-788	770	1950	44.5	3
HKPF90222003	transparent glass	○ chrome / silver glossy	870-888	840	1950	50.5	3

The adjustment range is 10 mm less than the length of the arm which is insert under the tile of the shower tray.

Recommended with the following shower trays:

HKPF80:

AKCENT	XBN0480
PACYFIK	XBN0780

HKPF90:

AKCENT	XBN0490
PACYFIK	XBN0790

Can be combined with other KOLO shower trays from the table "Sets of shower enclosures and trays".

ATTENTION! The real dimension of the shower enclosure is defined by the adjustment range.

○ Product available with Reflex Kolo coating ONLY.

*The maximum possible width of the shower enclosure.

In case of mounting the shower enclosure directly on the floor, boundaries required for installation are given on the first page of the manual.

Square-corner shower enclosure 80 x 80 cm* and 90 x 90 cm*. Opening to the outside.

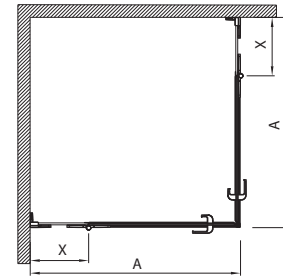
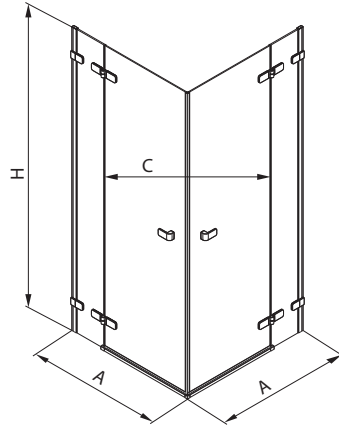

	X
HKDF80	191.5
HKDF90	241.5

Article No.	Description		A Adjustment range [mm]*	C Entrance width [mm]	H Height [mm]	Weight kg	Number of pcs. per pallet
	Glass type	Hinges/profile colour					
HKDF80222003	transparent glass	○ chrome / silver glossy	770-788	770	1950	59.0	4
HKDF90222003	transparent glass	○ chrome / silver glossy	870-888	840	1950	64.5	4

Recommended with the following shower trays:

HKDF80:

PACYFIK XBK0780

HKDF90:

PACYFIK XBK0790

Can be combined with other KOLO shower trays from the table "Sets of shower enclosures and trays".

ATTENTION! The real dimension of the shower enclosure is defined by the adjustment range.

○ Product available with Reflex Kolo coating ONLY.

*The maximum possible width of the shower enclosure.

In case of mounting the shower enclosure directly on the floor, boundaries required for installation are given on the first page of the manual.

Wing door to the niche 80 cm*, 90 cm*, 100 cm* and 120 cm*, left and right. Opening to the outside.

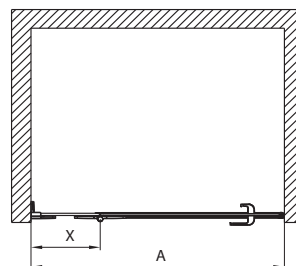
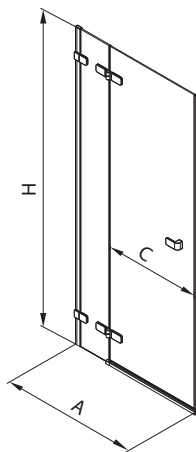

	X
HDRF80	191.5
HDRF90	241.5
HDRF10	241.5
HDRF12	341.5

Wing door HDRF, left on the photo

Article No.	Description		A Adjustment range [mm]*	C Entrance width [mm]	H Height [mm]	Weight kg	Number of pcs. per pallet
	Glass type	Hinges/profile colour					
HDRF80222003L	transparent glass	○ silver glossy	782 - 800	562	1950	35.0	5
HDRF80222003R	transparent glass	○ silver glossy	782 - 800	562	1950	35.0	5
HDRF90222003L	transparent glass	○ silver glossy	882-900	612	1950	38.0	5
HDRF90222003R	transparent glass	○ silver glossy	882-900	612	1950	38.0	5
HDRF10222003L	transparent glass	○ silver glossy	982-1000	712	1950	42.0	5
HDRF10222003R	transparent glass	○ silver glossy	982-1000	712	1950	42.0	5
HDRF12222003L	transparent glass	○ silver glossy	1182-1200	812	1950	49.5	5
HDRF12222003R	transparent glass	○ silver glossy	1182-1200	812	1950	49.5	5

Recommended with the following shower trays:

HDRF80:

PACYFIK 80/80 XBK0780

HDRF90:

PACYFIK 90/90 XBK0790

HDRF10:

PACYFIK 100/100 XBK0710

PACYFIK 100/80 XBP0718

PACYFIK 100/90 XBP0719

HDRF12:

PACYFIK 120/80 XBP0780

PACYFIK 120/90 XBP0729

ATTENTION! The real dimension of the shower enclosure is defined by the adjustment range.

○ Product available with Reflex Kolo coating ONLY.

*The maximum possible width of the shower enclosure.

In case of mounting the shower enclosure directly on the floor, boundaries required for installation are given on the first page of the manual.

Wing door to the niche 80 cm*, 90 cm*, 100 cm* and 120 cm*, left and right with railing. Opening to the outside.

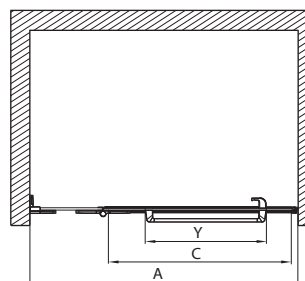
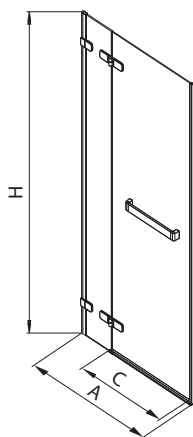

	Y
HDRF80	400
HDRF90	400
HDRF10	550
HDRF12	550

Wing door HDRF with railing, left on the photo

Article No.	Description		A Adjustment range [mm]*	C Entrance width [mm]	H Height [mm]	Weight kg	Number of pcs. per pallet
	Glass type	Hinges/profile colour					
HDRF80222R03L	transparent glass	○ silver glossy	782 - 800	562	1950	35.0	5
HDRF80222R03R	transparent glass	○ silver glossy	782 - 800	562	1950	35.0	5
HDRF90222R03L	transparent glass	○ silver glossy	882-900	612	1950	38.0	5
HDRF90222R03R	transparent glass	○ silver glossy	882-900	612	1950	38.0	5
HDRF10222R03L	transparent glass	○ silver glossy	982-1000	712	1950	42.0	5
HDRF10222R03R	transparent glass	○ silver glossy	982-1000	712	1950	42.0	5
HDRF12222R03L	transparent glass	○ silver glossy	1182-1200	812	1950	49.5	5
HDRF12222R03R	transparent glass	○ silver glossy	1182-1200	812	1950	49.5	5

Recommended with the following shower trays:

HDRF80:

PACYFIK 80/80

XBK0780

HDRF90:

PACYFIK 90/90

XBK0790

HDRF10:

PACYFIK 100/100

XBK0710

PACYFIK 100/80

XBP0718

PACYFIK 100/90

XBP0719

HDRF12:

PACYFIK 120/80

XBP0780

PACYFIK 120/90

XBP0729

ATTENTION! The real dimension of the shower enclosure is defined by the adjustment range.

○ Product available with Reflex Kolo coating ONLY.

*The maximum possible width of the shower enclosure.

In case of mounting the shower enclosure directly on the floor, boundaries required for installation are given on the first page of the manual.

NEXT

Series available with  Reflex Kolo coating

Wing door 80 cm*, 90 cm*, 100 cm* and 120 cm*, left and right. Can be combined ONLY with NEXT HSKX side walls. Opening to the outside (mounting support included in set).

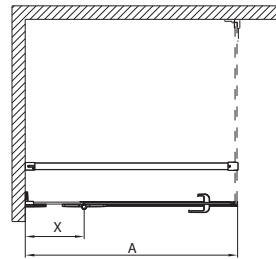
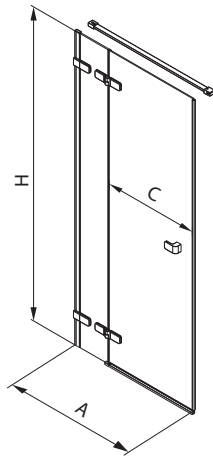

	X
HDSF80	191.5
HDSF90	241.5
HDSF10	241.5
HDSF12	341.5

Wing door HDSF, left, and NEXT side wall on the photo

Article No.	Description		A Adjustment range [mm]*	C Entrance width [mm]	H Height [mm]	Weight kg	Number of pcs. per pallet
	Glass type	Hinges/profile colour					
HDSF80222003L	transparent glass	○ silver glossy	770-788	538	1950	34.5	5
HDSF80222003R	transparent glass	○ silver glossy	770-788	538	1950	34.5	5
HDSF90222003L	transparent glass	○ silver glossy	870-888	588	1950	38.0	5
HDSF90222003R	transparent glass	○ silver glossy	870-888	588	1950	38.0	5
HDSF10222003L	transparent glass	○ silver glossy	970-988	688	1950	42.0	5
HDSF10222003R	transparent glass	○ silver glossy	970-988	688	1950	42.0	5
HDSF12222003L	transparent glass	○ silver glossy	1170-1188	788	1950	49.5	5
HDSF12222003R	transparent glass	○ silver glossy	1170-1188	788	1950	49.5	5

Recommended with the following shower trays:

HDSF80:

PACYFIK 80/80 XBK0780

HDSF90:

PACYFIK 90/90 XBK0790

HDSF10:

PACYFIK 100/100 XBK0710

PACYFIK 100/80 XBP0718

PACYFIK 100/90 XBP0719

HDSF12:

PACYFIK 120/80 XBP0780

PACYFIK 120/90 XBP0729

ATTENTION! The real dimension of the shower enclosure is defined by the adjustment range.

○ Product available with Reflex Kolo coating ONLY.

*The maximum possible width of the shower enclosure.

In case of mounting the shower enclosure directly on the floor, boundaries required for installation are given on the first page of the manual.

Wing door 80 cm*, 90 cm*, 100 cm* and 120 cm*, left and right with railing. Can be combined ONLY with NEXT HSKX side walls. Opening to the outside (mounting support included in set).

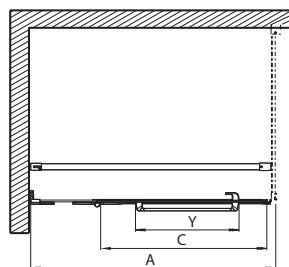
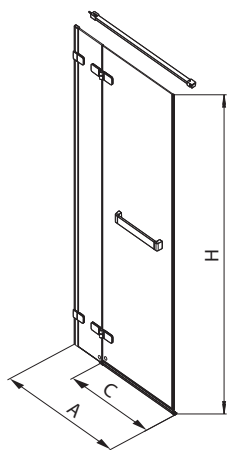

	Y
HDSF80	376
HDSF90	376
HDSF10	526
HDSF12	526

Wing door HDSF with railing, left towel rail and NEXT side wall on the photo

Article No.	Description		A Adjustment range [mm]*	C Entrance width [mm]	H Height [mm]	Weight kg	Number of pcs. per pallet
	Glass type	Hinges/profile colour					
HDSF80222R03L	transparent glass	○ silver glossy	770-788	538	1950	34.5	5
HDSF80222R03R	transparent glass	○ silver glossy	770-788	538	1950	34.5	5
HDSF90222R03L	transparent glass	○ silver glossy	870-888	588	1950	38.0	5
HDSF90222R03R	transparent glass	○ silver glossy	870-888	588	1950	38.0	5
HDSF10222R03L	transparent glass	○ silver glossy	970-988	688	1950	42.0	5
HDSF10222R03R	transparent glass	○ silver glossy	970-988	688	1950	42.0	5
HDSF12222R03L	transparent glass	○ silver glossy	1170-1188	788	1950	49.5	5
HDSF12222R03R	transparent glass	○ silver glossy	1170-1188	788	1950	49.5	5

Recommended with the following shower trays:

HDSF80:

PACYFIK 80/80 XBK0780

HDSF90:

PACYFIK 90/90 XBK0790

HDSF10:

PACYFIK 100/100 XBK0710

PACYFIK 100/80 XBP0718

PACYFIK 100/90 XBP0719

HDSF12:

PACYFIK 120/80 XBP0780

PACYFIK 120/90 XBP0729

ATTENTION! The real dimension of the shower enclosure is defined by the adjustment range.

○ Product available with Reflex Kolo coating ONLY.

*The maximum possible width of the shower enclosure.

In case of mounting the shower enclosure directly on the floor, boundaries required for installation are given on the first page of the manual.

NEXT

Series available with  Reflex Kolo coating

Side wall 80 cm*, 90 cm*, 100 cm* and 120 cm*. Can be combined with NEXT HDSF wing door.

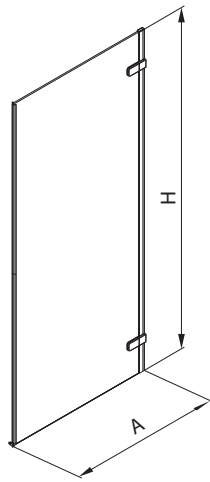

Wing door HDSF, left and NEXT side wall on the photo

Article No.	Description		A Adjustment range [mm]*	C Entrance width [mm]	H Height [mm]	Weight kg	Number of pcs. per pallet
	Glass type	Hinges/profile colour					
HSKX80222003	transparent glass ○	chrome / silver glossy	770 - 988	-	1950	39.0	5
HSKX90222003	transparent glass ○	chrome / silver glossy	870 - 888	-	1950	43.0	5
HSKX10222003	transparent glass ○	chrome / silver glossy	970 - 988	-	1950	46.0	5
HSKX12222003	transparent glass ○	chrome / silver glossy	1170 - 1188	-	1950	56.5	5

Recommended with the following shower trays:

HSKX80:

PACYFIK 80/80	XBK0780
PACYFIK 120/80	XBP0780
PACYFIK 100/80	XBP0718

HSKX90:

PACYFIK 90/90	XBK0790
PACYFIK 100/90	XBP0719
PACYFIK 120/90	XBP0729

HSKX10:

PACYFIK 100/100	XBK0710
-----------------	---------

HSKX12:

PACYFIK 120/80	XBP0780
----------------	---------

ATTENTION! The real dimension of the shower enclosure is defined by the adjustment range.

○ Product available with Reflex Kolo coating ONLY.

*The maximum possible width of the shower enclosure.

In case of mounting the shower enclosure directly on the floor, boundaries required for installation are given on the first page of the manual.

**Side wall 80 cm*, 90 cm*, 100 cm* and 120 cm* with railing.
Can be combined with NEXT HDSF wing door.**

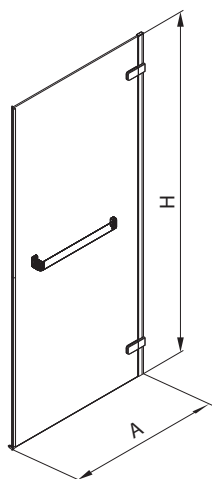

Wing door HDSF with railing, left and NEXT side wall on the photo.

Article No.	Description		A Adjustment range [mm]*	C Entrance width [mm]	H Height [mm]	Weight kg	Number of pcs. per pallet
	Glass type	Hinges/profile colour					
HSKX80222R03	transparent glass ○	chrome / silver glossy	770 - 788	-	1950	39.0	5
HSKX90222R03	transparent glass ○	chrome / silver glossy	870 - 888	-	1950	43.0	5
HSKX10222R03	transparent glass ○	chrome / silver glossy	970 - 988	-	1950	46.0	5
HSKX12222R03	transparent glass ○	chrome / silver glossy	1170 - 1188	-	1950	56.5	5

Recommended with the following shower trays:

HSKX80:

PACYFIK 80/80	XBK0780
PACYFIK 120/80	XBP0780
PACYFIK 100/80	XBP0718

HSKX90:

PACYFIK 90/90	XBK0790
PACYFIK 100/90	XBP0719
PACYFIK 120/90	XBP0729

HSKX10:

PACYFIK 100/100	XBK0710
-----------------	---------

HSKX12:

PACYFIK 120/80	XBP0780
PACYFIK 120/90	XBP0729

ATTENTION! The real dimension of the shower enclosure is defined by the adjustment range.

○ Product available with Reflex Kolo coating ONLY.

*The maximum possible width of the shower enclosure.

In case of mounting the shower enclosure directly on the floor, boundaries required for installation are given on the first page of the manual.

Side wall for non-standard Walk-In type 50 cm*, 80 cm*, 90 cm*, 100 cm* and 120 cm*



The building of corner with walls (120 cm and 90 cm)

Examples of Walk-In solutions.

The type of construction, its size and the width of the entrance depend on the request of the end-customer.

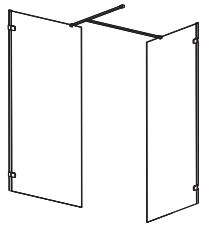

The approximate size of the basic part is 160 x 90 cm (the wall 100 cm and 90 cm).

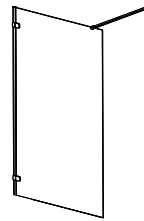

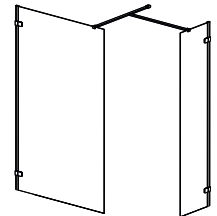

Examples of niche construction. The separately standing wall for the niche has a width from 80 cm to 120 cm.



The approximate size of the basic part is 160 x 90 cm or 160 x 80 cm (the wall 50 cm and 120 cm).

Article No.	Description		Adjustment range [mm]*	Height [mm]	Weight kg	Number of pcs. per pallet
	Glass type	Hinges/profile colour				
HSKX50222003	transparent glass	○ silver glossy	470-488	1950	25.5	5
HSKX80222003	transparent glass	○ silver glossy	770-788	1950	39.0	5
HSKX90222003	transparent glass	○ silver glossy	870-888	1950	43.0	5
HSKX10222003	transparent glass	○ silver glossy	970-988	1950	46.0	5
HSKX12222003	transparent glass	○ silver glossy	1170-1188	1950	56.5	5

Mounting supports for Walk- In wall

Article No.	Description	Colour		Weight kg	Number of pcs. per pallet
HSKC80003	mounting support	silver glossy		2.0	-
HSKC90003	mounting support	silver glossy		2.0	-
HSKC10003	mounting support	silver glossy		2.0	-
HSKC12003	mounting support	silver glossy		2.0	-
HSKB10003	mounting support of side wall	silver glossy		2.0	-
HSKD19003	Ceiling support 1950 mm	silver glossy		2.0	1
HSKD23003	Ceiling support 2300 mm	silver glossy		2.0	1

Can be completed with Pacyfik and Terra shower trays.

When using the side wall like Walk-In, its size is reduced by 15 mm. As a result the range of adjustment is decreased.

ATTENTION! The real dimension of the shower enclosure is defined by the adjustment range.

○ Product available with Reflex Kolo coating ONLY.

*The maximum possible width of the shower enclosure.

In case of mounting the shower enclosure directly on the floor, boundaries required for installation are given on the first page of the manual.