

Kartell by **LAUFEN**



PURE EMOTION

Design by
Ludovica+Roberto Palomba





Kartell by Laufen:

THE PERFECT

EMOTION

in bathroom



Ludovica+Roberto Palomba

A COMPLETE BATHROOM PROJECT INSPIRED BY THE ICONIC DESIGN OF KARTELL TOGETHER WITH THE QUALITY OF LAUFEN

It's a new dialogue. And despite involving semantically opposite universes, it is based on agreeing on a word. A concept. **This is the key that opens all design doors, as well as those for fashion and architecture. Excitement. This is the pass-key that brought together the iconic culture of Kartell's design and the innovation and quality from Laufen.**

An integrated research project that redefines the principles, shapes, and uses of what is an ever more important space in life today: the bathroom.

Their collaboration is also a compenetration. Because in the world that is taking shape "we" is more important than "I". And it does not stop at pronouns. Rather, it means having a strategy that valorises the skills to deal with the complexity of demand that is ever more diversified, layered, and often anaesthetised by too much uniformity in terms of what is on offer - because it is dulled by excessive beauty or functionality that either way, overlooks how important continuing to be excited really is. Every day.

That was behind the choice to entrust a project this important to the two best bathroom designers, the multi award-winning Ludovica+Roberto Palomba, to come up with something completely new using a material that, until very recently was merely a dream - SaphirKeramik. The result of lengthy technoeconomic research by Laufen, twice-as-strong, more ecological and thinner than ceramic. Stunning performance, granted; but also necessary in a society aiming at reducing consumption, that loves simplicity, and that is looking for a dynamic relationship with sensual pleasure.

The result is clear to see - ceramics with thin, almost live edges, the grooves in (solid surface) baths that house LEDS for chromotherapy, surfaces treated

with enamels in sophisticated colours, drain outlets that are invisible, hidden below essential slots, and assembly systems that are as innovative as they are easy. Then there's the monumentality, transparency, and purity of the elements, that take an ideal view of architectural volumes, while projecting these objects onto an exceptionally light horizon.

This lightness is accentuated by dialogue with the chunky, elegant and transparent plastic of furnishing accessories: stools/side tables, stackable units, shelves, mirrors and lamps. Just like phrases for effect in a conversation overall, they stand out for their irony. They are nomadic, versatile. And depending on their colour they change the mood of the bathroom, just like accessories change the conception of a garment: blue adds the strength of serenity, tangerine orange gives a sun-like accent, amber adds body, smoky ink outlines profiles like eye liner, while full-on white and black are structurally imposing compared to the transparent lack of structure.

And it is in the texture of the background, always changing, that the stage of emotions finally becomes complete. Feelings that change like bathroom styles change - interior space par excellence that has to then be adapted to the various personalities, while maintaining design coherency. Just like dialogue between opposite poles: lightness and weight, play and rigour, eclecticism and minimalism. Functional binomials of modern-day creativity, just like the two brands, Laufen and Kartell.

Now joining forces in a shared project that is a tribute to innovation and iconicity.

_Federico Chiara / Vogue Italia



Laufen Company
near Basel, Switzerland
[2012]



Kartell Company
Milano, Italy
[2012]

INNOVATION /techno-eco-logical research

Kartell by Laufen

Ein komplettes Bad inspiriert durch das ikonische Design von Kartell und der Qualität von Laufen

Es handelt sich um einen neuen Dialog. Obwohl semantisch entgegengesetzte Universen hinzugezogen werden, basiert alles auf einem gemeinsamen Wort. Das Konzept. Ein Schlüssel, der heutzutage sowohl alle Türen des Designs als auch alle Türen der Mode und der Architektur öffnet. Die Emotion.

Dies ist das Passepartout, das die ikonische Kultur des Kartell-Designs mit der Innovation und der Qualität von Laufen hat zusammentreffen lassen.

Ein integriertes Projekt einer Suche, welche die Prinzipien, die Formen und die Verwendung eines immer

wichtigeren Raumes des zeitgenössischen Lebens neu definiert: das Badezimmer.

Eine Zusammenarbeit, die auch ein gegenseitiges Durchdringen ist. Denn in der Welt die sich abzeichnet, ist das „wir“ wichtiger als das „ich“. Und es geht hier nicht nur um die Pronomina. Es geht um die Strategie, Kompetenzen hervorzuheben, die dazu dienen die Vielschichtigkeit eines immer diversifizierten Bedürfnisses hervorzuheben. Ein Bedürfnis das oftmals durch ein zu einseitiges Angebot betäubt und durch einen Exzess an Ästhetik und Zweckmäßigkeit abgeflacht wird, der in dem einen oder anderen Fall vergisst, wie wichtig auch weiterhin Emotionen sind. Tag für Tag.

So erfolgte also die Wahl, den zwei besten Badezimmer-Designern, den mehrfach ausgezeichneten Ludovica+Roberto Palomba, ein so wichtiges Projekt anzuvertrauen, um etwas vollkommen Neues zu erschaffen. Mit einem Material, das bis gestern nicht





existierte, und wenn, dann nur in den Träumen: SaphirKeramik. Das Ergebnis einer langjährigen techno-öko-logischen Forschung von Laufen erweist sich als zwei Mal biegefest, noch umweltschonender und dünner als Keramik. Erstaunliche Leistungen, mit Sicherheit; aber eben notwendig in einer Gesellschaft, welche einer Konsumsenkung entgegenschreitet, welche die Einfachheit liebt und sich auf die Suche einer dynamischen Beziehung mit der Wahrnehmung begibt.

Das Ergebnis sieht man: Die Keramiken haben feinste, fast schon scharfe Kanten, der lineare Überlauf der Badewanne (aus Solid Surface) beherbergt LEDs zur Farbtherapie, die keramischen Oberflächen werden in anspruchsvollen Farben glasiert und eingebrannt, die Abflüsse sind unsichtbar und verstecken sich hinter reduzierten Schlitzten, die Montagesysteme sind sowohl innovativ als auch einfach. Und durch die Monumentalität, die Transparenz, die Reinheit der Elemente, die sich ideal auf die Volumina der Architektur beziehen, bewegen sich diese Gegenstände in einer Sphäre ungewöhnlicher Leichtigkeit.

Eine Leichtigkeit die durch den Dialog mit dem vollen, gleichwohl eleganten und transparenten Plastik der Stil- und Einrichtungsobjekte betont wird: Hocker/Tischen, stapelbare Möbelstücke, Konsolen, Spiegel und Lampen. Wie einleitende Formulierungen in einer Ansprache, stechen diese durch ihre Ironie hervor. Sie sind Nomaden, vielseitig. Und je nach ihrer Farbe, ändern sie die Stimmung des Bades, genauso wie die Accessoires das Konzept eines Kleides ändern: Das Blau verleiht die Stärke der Gelassenheit, das Tangerinenorange projiziert den Akzent der Sonne, die Bernsteinfarbe gibt Fülle, das rauchfarbene Fumé zeichnet die Profile eines Eyeliners, das satte Weiß und Schwarz behaupten die Struktur, während das Transparente diese aufbricht.

Und in der durchgehend wandelbaren Materialität der Hintergründe komplettiert sich das Szenarium der Emotionen. Emotionen, die sich abwechseln, so wie sich die Stile des Bades - des Wohnraums schlechthin - abwechseln, um sich den verschiedenen Persönlichkeiten anzupassen, ohne die Kohärenz des Projektes zu verlieren. Ein Dialog zwischen den Polen: Leichtigkeit und Gewicht, Spiel und Strenge, Eklektizismus und Minimalismus. Kombinationen, die für die Kreativität des Zeitgenössischen zweckmäßig sind, so wie die beiden Marken Laufen und Kartell.

Heute durch ein gemeinsames Projekt verbunden, das ein Tribut an die Innovation und an die Ikonizität ist.

_Federico Chiara / Vogue Italia



**TRANSPARENT
AND GREY**
/sophisticated
urban mood



UN PROGETTO COMPLETO PER IL BAGNO ISPIRATO DAL DESIGN ICONICO DI KARTELL CON LA QUALITÀ DI LAUFEN

E' un dialogo nuovo.

E pur coinvolgendo universi semantici opposti, si basa sulla condivisione di una parola. Un concetto. Una chiave che oggi apre tutte le porte del design, così come quelle della moda e dell'architettura. L'emozione.

Questo è il passepartout che ha fatto incontrare la cultura iconica del design di Kartell con l'innovazione e la qualità di Laufen, generando un progetto integrato di ricerca che ridefinisce i principi, le forme e gli usi di uno spazio sempre più importante nel vivere contemporaneo: la stanza da bagno.

La loro collaborazione è anche compenetrazione. Perché nel mondo che si profila, il "noi" è più importante dell'"io". E non si tratta, solo, di pronomi. Ma di possedere una strategia che valorizzi le competenze per affrontare la complessità di una richiesta sempre più diversificata, stratificata, e spesso anestetizzata dall'offerta troppo uniforme - perché appiattita da un eccesso di estetismo o di funzionalità che, in un caso o nell'altro, dimentica quanto sia importante continuare a emozionarsi. Ogni giorno.

Ecco allora, la scelta di affidare un progetto così importante ai due migliori designer del bagno, i pluripremiati Ludovica+Roberto Palomba, per creare qualcosa di completamente nuovo con un materiale che, fino a ieri, non esisteva se non nei sogni: la SaphirKeramik. Frutto di una lunga ricerca tecno-eco-logica di Laufen, risulta due volte più resistente, più ecologica e più sottile della ceramica. Performance sorprendenti, certo; ma necessarie in una società che va verso la riduzione dei consumi, che ama la semplicità e ricerca un rapporto dinamico con la sensorialità.





Il risultato si vede: le ceramiche hanno bordi sottilissimi, quasi a spigolo vivo, le scanalature della vasca (in Solid Surface) ospitano led per la cromoterapia, le superfici sono trattate con smalti dai colori sofisticati, gli scarichi sono invisibili, nascosti sotto feritoie essenziali, i sistemi di montaggio sono tanto innovativi quanto facili. E la monumentalità, la trasparenza, la purezza degli elementi, che idealmente guardano ai volumi dell'architettura, proiettano però questi oggetti in un orizzonte di insolita leggerezza.

Una leggerezza accentuata dal dialogo con la corposa, elegante e trasparente plastica dei complementi d'arredo: sgabelli/tavolini, mobiletti impalabili, mensole, specchi e lampade. A guisa di frasi ad effetto in un discorso complessivo, spiccano per l'ironia. Sono nomadi, versatili. E a seconda del loro colore mutano l'umore del bagno, esattamente come gli accessori cambiano il concetto di un vestito: il blu conferisce la forza della serenità, l'arancio tangerine proietta l'accento del sole, l'ambra dà corpo, l'inchiostro fumé disegna i profili come un eyeliner, il bianco e il nero pieni si impongono strutturalmente, il trasparente destruttura.

E nella matericità degli sfondi, sempre mutevoli, si completa il palcoscenico delle emozioni. Emozioni che variano come variano gli stili del bagno - spazio interiore per eccellenza, che si deve quindi adattare alle diverse personalità, mantenendo però una coerenza di progetto. Così come il dialogo tra polarità: leggerezza e peso, gioco e rigore, eclettismo e minimalismo. Binomi funzionali alla creatività del contemporaneo, così come lo sono i due marchi Laufen e Kartell.

Uniti oggi da un progetto condiviso che è un tributo all'innovazione e all'iconicità.

_Federico Chiara / Vogue Italia







Kartell by Laufen

Un projet complet pour salle de bain inspiré par le design iconique de Kartell avec la qualité de Laufen

C'est un dialogue nouveau. Et bien que mêlant des univers sémantiques opposés, il se base sur une parole commune. Un concept. Une clé qui aujourd'hui ouvre toutes les portes du design ainsi que celles de la mode et de l'architecture. L'émotion.

C'est là le passe-partout qui a fait rencontrer la culture iconique du design Kartell avec l'innovation et la qualité Laufen.

Un projet de recherche intégré qui redéfinit les principes, les formes et les usages d'un espace toujours plus important de la vie contemporaine: la salle de bains.

Leur collaboration est également compénétration. Car dans le monde qui se profile, le « nous » est plus important que le « moi ». Et il ne s'agit pas uniquement de pronoms. Mais bien de posséder une stratégie qui valorise les compétences pour faire face à la complexité d'une demande toujours plus diversifiée, stratifiée et souvent anesthésiée par une offre trop uniforme – car banalisée par un excès d'esthétisme ou de fonctionnalité qui, dans un cas comme dans l'autre, oublie combien il est important de continuer à s'é mouvoir. Chaque jour.

Voilà comment s'explique le choix de confier un projet aussi important aux deux meilleurs designers de salles de bains, Ludovica+Roberto Palomba, maintes fois récompensés, afin de créer quelque chose de totalement nouveau avec un matériau qui, il y a encore peu, appartenait au monde des rêves : le SaphirKeramik. Fruit d'une longue recherche techno-éco-logique de Laufen, il est deux fois plus résistant, plus écologique et plus fin que la céramique. Des performances remarquables, certes, mais nécessaires dans une société qui s'oriente



vers une diminution de la consommation, qui aime la simplicité et recherche un rapport dynamique avec la sensorialité.

Le résultat est au rendez-vous: les céramiques possèdent des bords ultra fins presque à arête vive, les rainures de la baignoire (en Solid Surface) accueillent des DEL pour la chromothérapie, les surfaces sont traitées avec des émaux aux coloris sophistiqués, les vidanges sont invisibles, cachées sous des fentes essentielles, les systèmes de montage sont aussi novateurs que simples. La monumentalité, la transparence, la pureté des éléments, qui s'inspirent idéalement des volumes de l'architecture, placent néanmoins ces objets dans un horizon de légèreté insolite.

Une légèreté accentuée par le dialogue avec le plastique riche, élégant et transparent des meubles d'appoint : tabourets/petites tables, petits meubles empilables, étagères, miroirs et lampes. Pareils à des phrases à effet dans un discours d'ensemble, ils tranchent par leur ironie. Ce sont des nomades, polyvalents. Et en fonction de leurs coloris ils modifient l'humeur de la salle de bains, tout comme les accessoires transforment le concept d'un vêtement : le bleu donne la force de la sérénité, l'orange tangerine fait résonner l'accent du soleil, l'ambre donne du corps, le coloris encre fumé dessine les contours comme un ligneur, le noir et le blanc saturés s'imposent structurellement, la transparence déstructure.

Et dans la matérialité des fonds, toujours changeants, la scène des émotions est parachevée. Des émotions qui varient comme varient les styles de la salle de bains – espace intérieur par excellence, qui doit donc s'adapter aux différentes personnalités, en conservant cependant une cohérence de projet. Tout comme le dialogue des contraires: légèreté et pesanteur, jeu et rigueur, éclectisme et minimalisme. Des binômes fonctionnels pour la créativité contemporaine, comme le sont les deux marques Laufen et Kartell unies aujourd'hui par un projet commun, véritable hommage à l'innovation et à l'iconicité.

_Federico Chiara / Vogue Italia





THE KARTELL
TOUCH
/breaking the rules

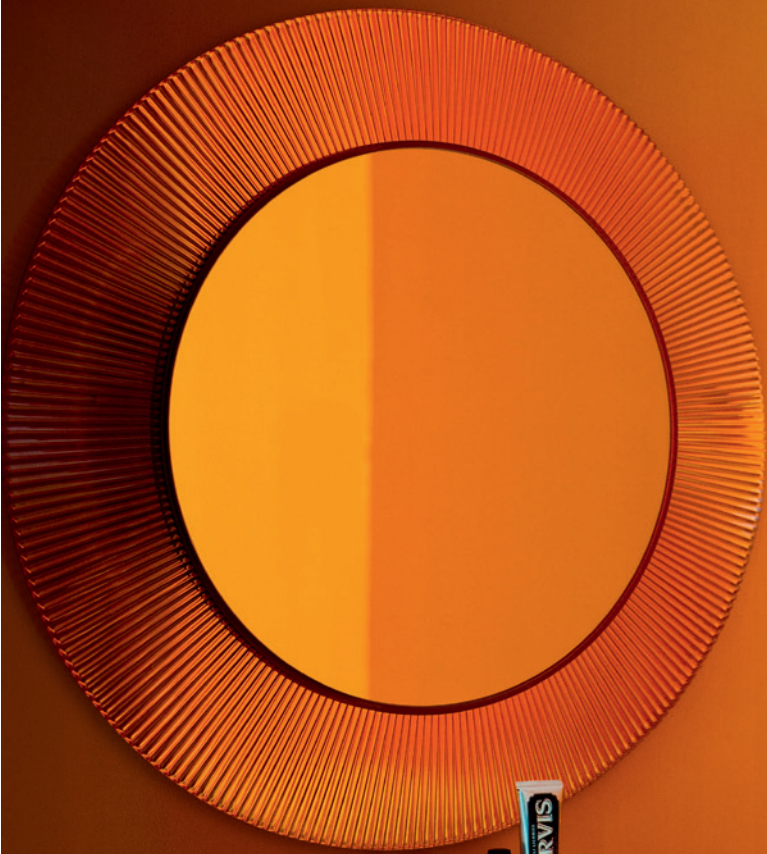



_IN THE ROUND



SHAVING FOAM
MARVIS
SHAVING CREAM

MARVIS



GEOMETRIC SET





Kortell-LAUFEN





COMPLEMENTS AND TOOLS NOMAD'S LAND

And it is in the texture of the background, always changing,
that the stage of emotions finally becomes complete.

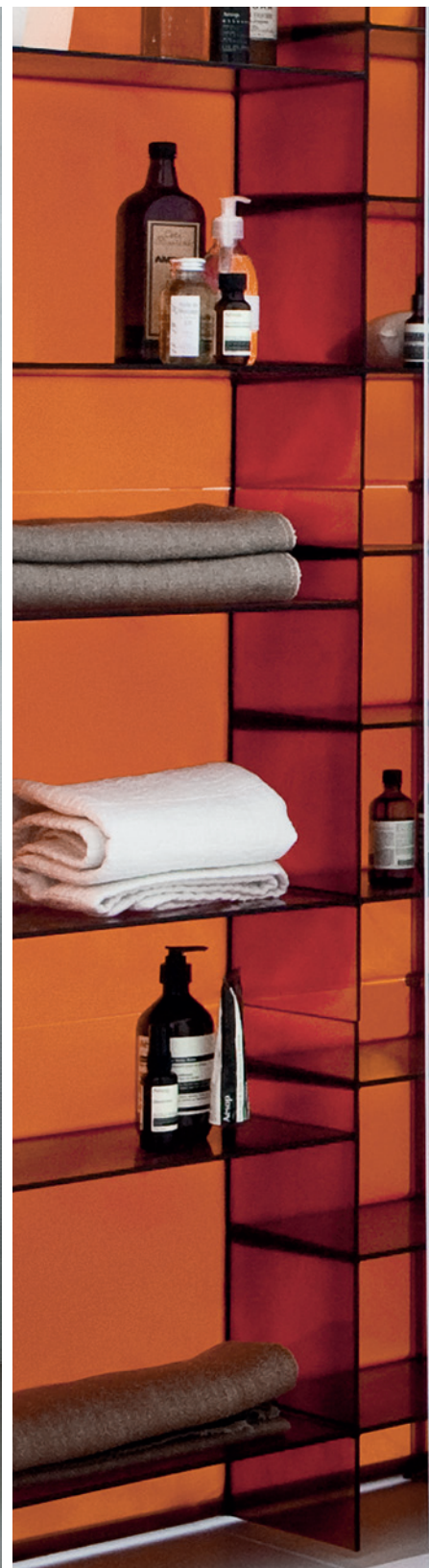

PLASTIC MOOD
[amber]

PLASTIC MOOD
[orange tangerine]



_A concept. This is the key that opens doors to design,
as well as those for fashion and architecture. Excitement.

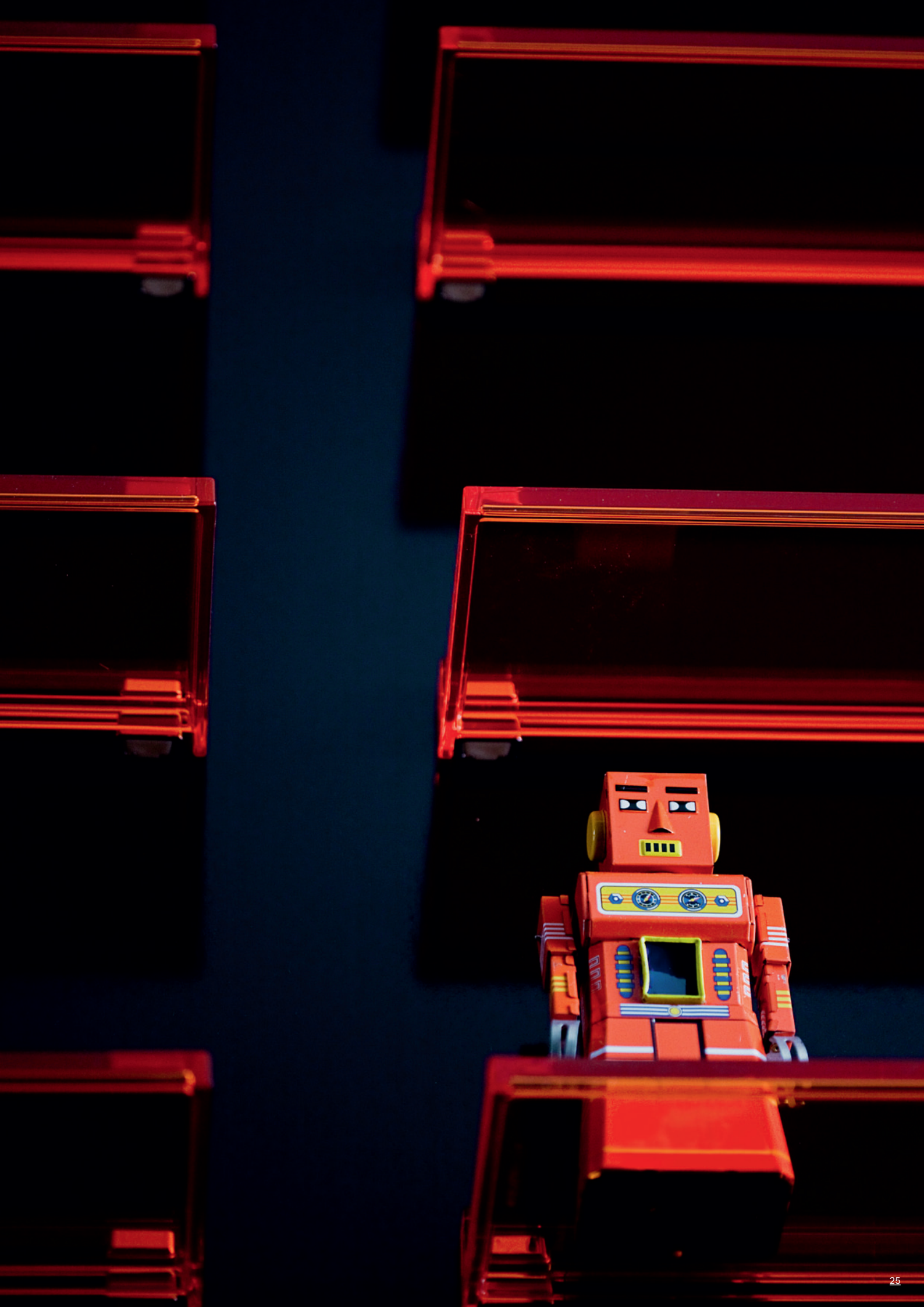



PLASTIC MOOD
[orange tangerine]





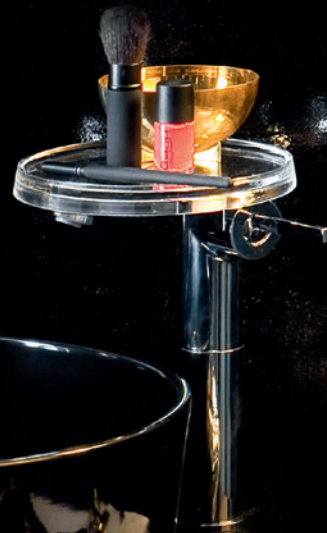
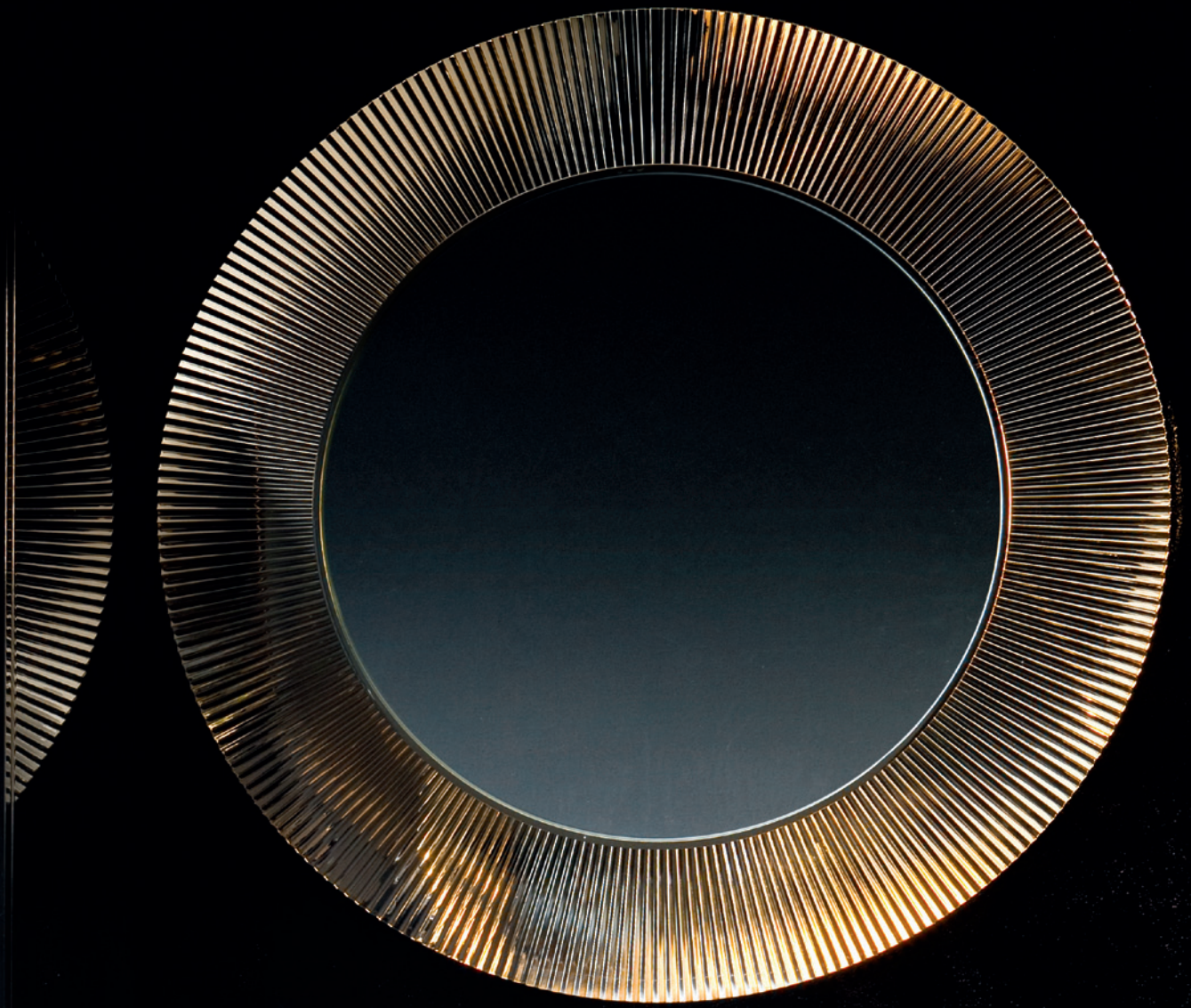



_oh my gold!



Karrell-LAUFEN

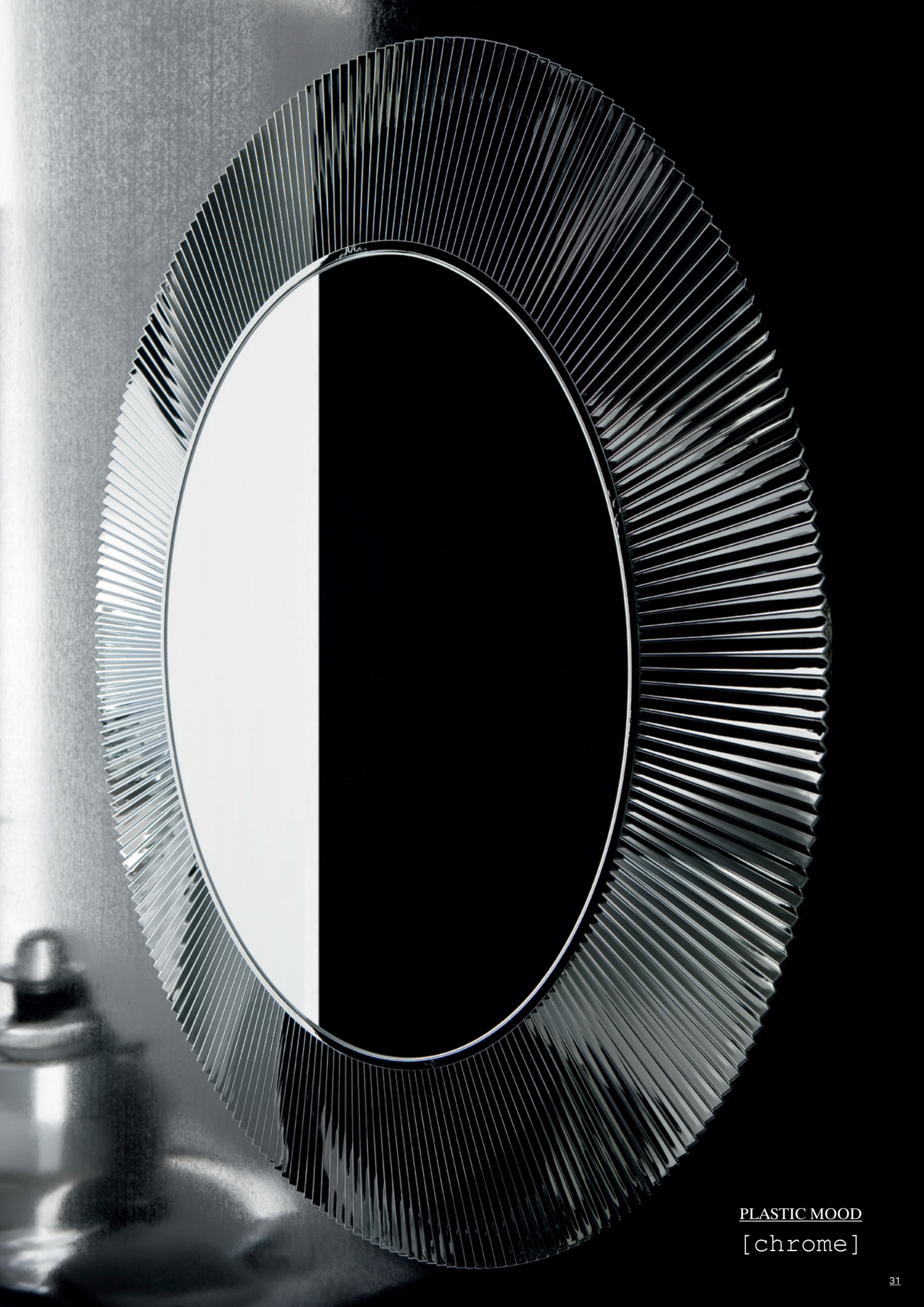

PLASTIC MOOD
[chrome]

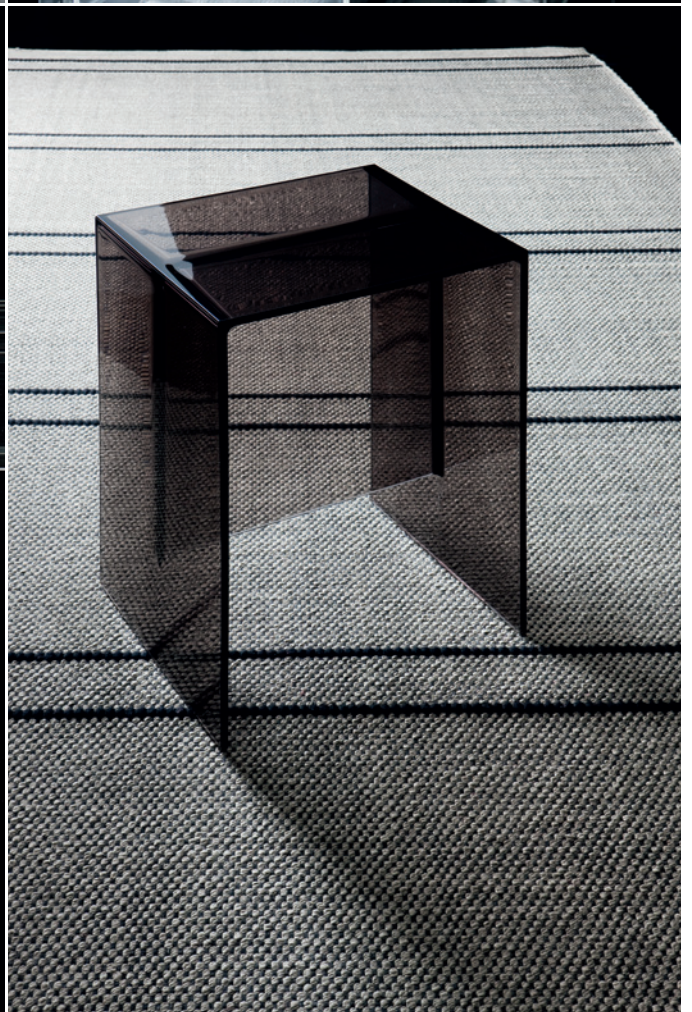



PLASTIC MOOD

[fumé]



_CRYSTAL AND BLACK
/strike back



PLASTIC MOOD
[crystal transparent]





CRYSTAL /transparent







WALL-HUNG
FLOOR
STANDING
OVATION



PURE ARCHITECTURE /industrial design



_Then there's the monumentality, transparency, and purity of the elements, that take an ideal view of architectural volumes, while projecting these objects onto an exceptionally light horizon.









FREE
STANDING
/bathtub the
new wave

SPLASH



PLASTIC MOOD
[ink blue]





_INTO THE NIGHT

/SPA time

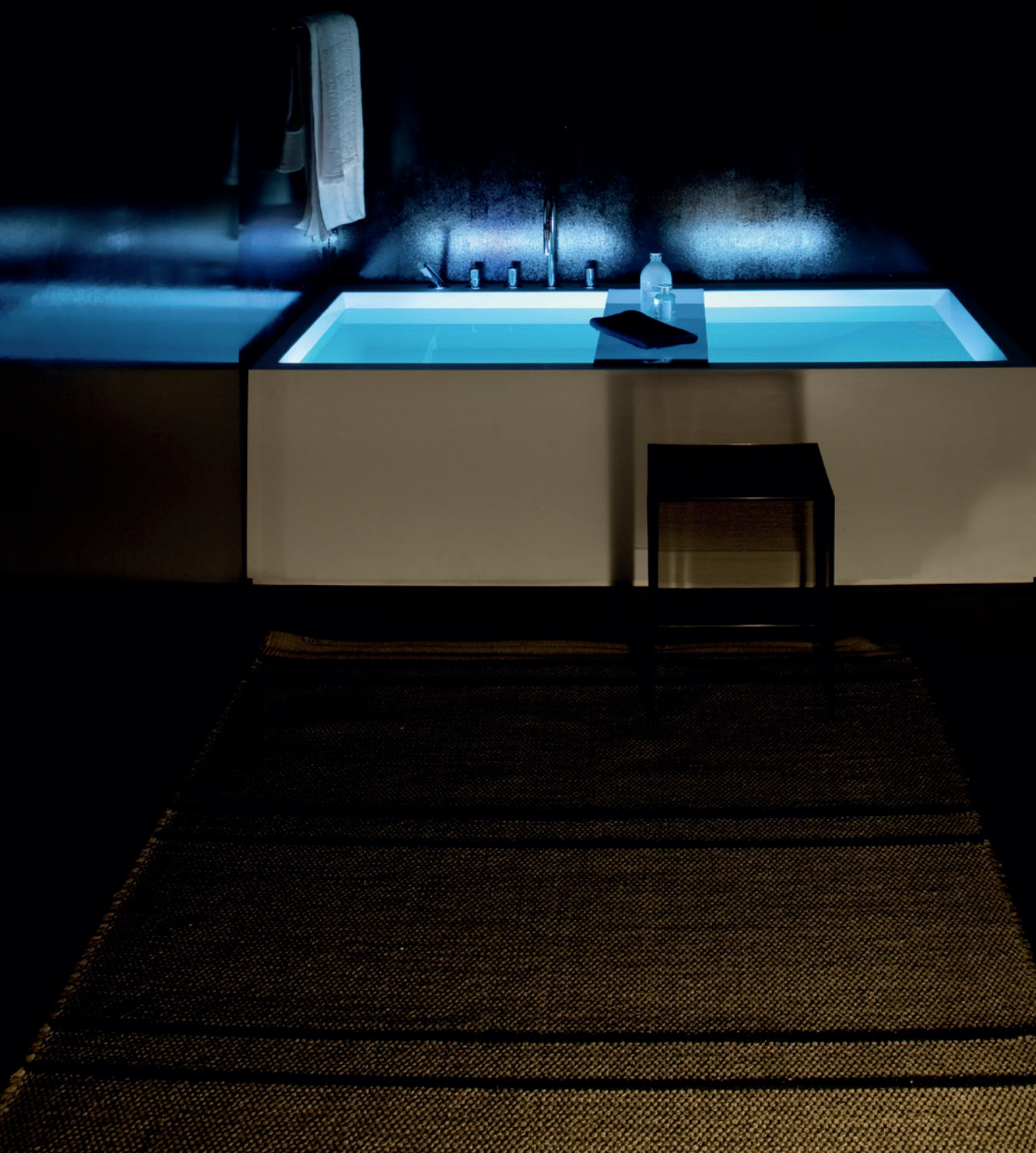

LIGHT



SHADOW





_This lightness is accentuated by dialogue with the chunky, elegant and transparent plastic of furnishing accessories: stools/side tables, stackable units, shelves, mirrors and lamps. Just like phrases for effect in a conversation overall, they stand out for their irony.



WASHBASIN

_900



WASHBASIN

_460



_BASIN
INSTINCT
/form follows
function_
/function
follows form



WASHBASIN
_600 RIGHT

SENSUALITY
/lightness





PLASTIC MOOD
[transparent and chrome]







[white/gold]



_Just like a dialogue between opposite poles:
lightness and weight, play and rigour, eclecticism
and minimalism.





_Now joining forces in a shared project that is a tribute to innovation and iconicity.

REFLECTED
/ GLORY





_TWILIGHT ZONE







81133.1 ○/●/●●●
Freestanding washbasin, with special hidden outlet
Freistehender Waschtisch mit speziellem, verstecktem Ablauf
Lavabo indépendant, avec trop-plein special caché
Lavabo a colonna, con scarico speciale nascosto

Colours:
 .000 .020 .400

Options:
 .111 .112 .158

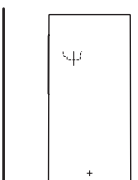
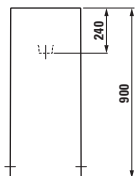
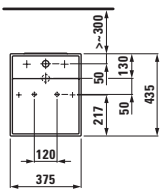

81233.1 ○
Washbasin bowl
Waschtisch-Schale
Lavabo à poser
Bacinella

Colours:
 .000 .020 .400 .757 .759

Options:
 .112

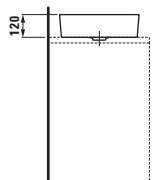
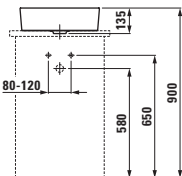
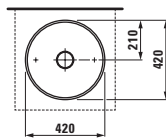

81233.2 ○/●/●●●
Washbasin bowl with tapbank, with special hidden outlet
Waschtisch-Schale mit Armaturenbank, mit speziellem, verstecktem Ablauf
Lavabo à poser avec plage de la robinetterie, avec trop-plein special caché
Bacinella con piano per rubinetteria, con scarico speciale nascosto

Colours:
 .000 .020 .400 .757 .759

Options:
 .111 .112 .158 .104 .108

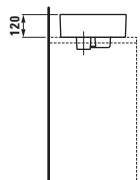
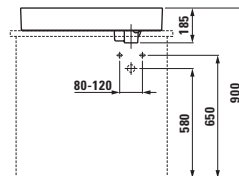
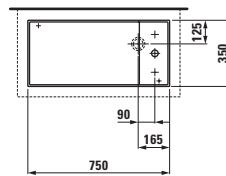

81533.1 ○/●/●●●
Small washbasin, with special hidden outlet
Handwaschbecken mit speziellem, verstecktem Ablauf
Lave-mains, avec trop-plein special caché
Lavamani, con scarico speciale nascosto

Colours:
 .000 .020 .400 .757 .759

Options:
 .111 .112 .158 .104 .108

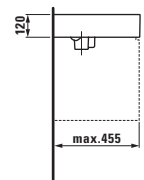
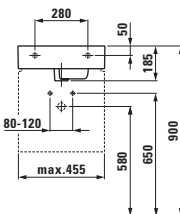
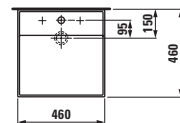



81033.4 ○/●/●●●
Washbasin, shelf right, with special hidden outlet

Waschtisch, Ablage rechts, mit speziellem, verstecktem Ablauf
 Lavabo, tablette à droite, avec trop-plein special caché
 Lavabo, mensola a destra, con scarico speciale nascosto

Colours:
 .000 .020 .400 .757 .759

Options:
 .111 .112 .158 .104 .108

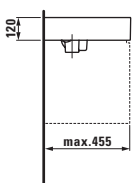
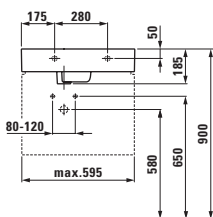
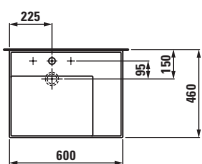

81033.5 ○/●/●●●
Washbasin, shelf left, with special hidden outlet

Waschtisch, Ablage links, mit speziellem, verstecktem Ablauf
 Lavabo, tablette à gauche, avec trop-plein special caché
 Lavabo, mensola a sinistra, con scarico speciale nascosto

Colours:
 .000 .020 .400 .757 .759

Options:
 .111 .112 .158 .104 .108

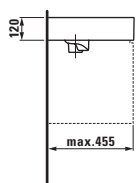
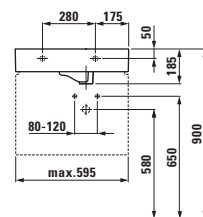
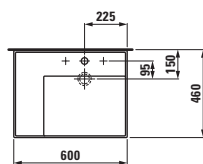

81033.9 ○/●/●●●
Washbasin, shelf left, with special hidden outlet

Waschtisch, Ablage links, mit speziellem, verstecktem Ablauf
 Lavabo, tablette à gauche, avec trop-plein special caché
 Lavabo, mensola a sinistra, con scarico speciale nascosto

Colours:
 .000 .020 .400 .757 .759

Options:
 .111 .112 .158 .104 .108

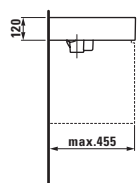
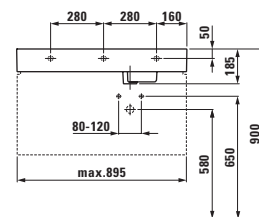
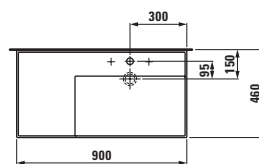



82033.1
Wall-hung WC, washdown
 Wand-WC, Tiefspüler
 WC suspendu, à chasse directe
 Vaso sospeso, a cacciata

Colours:
 .000 .400 .757

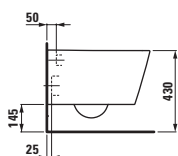
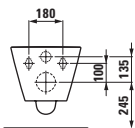
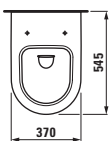

83033.1
Wall-hung bidet
 Wandbidet
 Bidet suspendu
 Bidet sospeso

Colours:
 .000 .400 .757

Options:
 .302

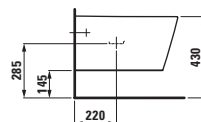
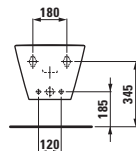
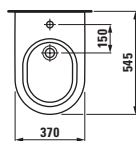

82333.1
Floorstanding WC, washdown, horizontal/vertical outlet, Vario
 Stand-WC, Tiefspüler, Abgang waagrecht/senkrecht, Vario
 WC au sol, à chasse directe, sortie horizontale / verticale, évacuation Vario
 Vaso a pavimento, a cacciata, scarico a parete/a pavimento, scarico Vario

Colours:
 .000 .400 .757

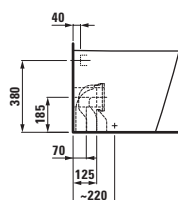
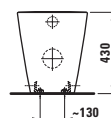

Floorstanding cistern, Dual Flush
 Stand-Spülkasten, Dual-Flush
 Réservoir au sol, Dual Flush
 Cassetta di risciacquo a pavimento, Dual Flush

82866.0
Water connection left or right at the top of the cistern
 Wasseranschluss links oder rechts oben am Spülkasten
 Raccordement de l'eau à gauche ou à droite sur le haut du réservoir
 Alimentazione dell'acqua a destra o a sinistra sulla parte superiore della cassetta di risciacquo

82866.1
Water connection back left at the top of the cistern
 Wasseranschluss hinten links oben am Spülkasten
 Raccordement de l'eau à l'arrière à gauche, sur le haut du réservoir
 Alimentazione dell'acqua posteriore sinistra sulla parte superiore della cassetta di risciacquo

82866.3
Water connection on the left side at the bottom of the cistern
 Wasseranschluss auf der linken Seite unten am Spülkasten
 Raccordement de l'eau à gauche sur le bas du réservoir
 Alimentazione dell'acqua a sinistra sulla parte inferiore della cassetta di risciacquo

82866.4
Water connection on the right side at the bottom of the cistern
 Wasseranschluss auf der rechten Seite unten am Spülkasten
 Raccordement de l'eau à droite sur le bas du réservoir
 Alimentazione dell'acqua a destra sulla parte inferiore della cassetta di risciacquo

Colours:
 .000 .400 .757

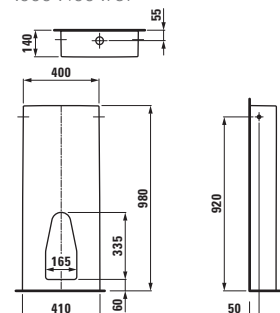



Floorstanding WC combination

Stand-WC Kombination
Combinaison WC au sol
Vaso monoblocco a pavimento

82333.1

Floorstanding WC, washdown, horizontal/vertical outlet, Vario

Stand-WC, Tiefspüler, Abgang waagerecht/senkrecht, Vario
Installation de WC au sol, à chasse directe, sortie horizontale / verticale, évacuation Vario

Vaso a pavimento, a cacciata, scarico a parete/a pavimento, scarico Vario

82866.x

Floorstanding cistern, Dual Flush

Stand-Spülkasten, Dual-Flush
Réservoir au sol, Dual Flush
Cassetta di risciacquo a pavimento, Dual Flush

Colours:

.000 .400 .757

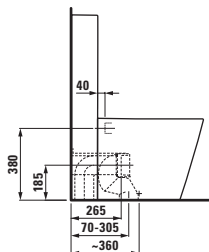
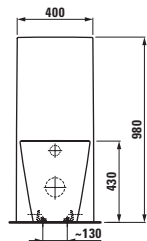
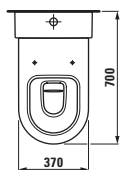

83233.1

Floorstanding bidet

Standbidet
Bidet au sol
Bidet a pavimento



89133.0

Seat and cover, removable

Sitz mit Deckel, abnehmbar
Siège et couvercle, amovible
Sedile con coperchio, estraibile

89133.1

Seat and cover, removable, with lowering system

Sitz mit Deckel, abnehmbar, mit Absenkautomatik
Siège et abattant, amovible, avec système d'abaissement
Sedile con coperchio, estraibile, con sistema a caduta rallentata

Colours:

.000 .757

Colours:

.000 .400 .757

Options:

.302 .308

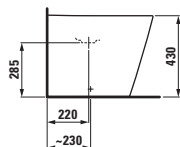
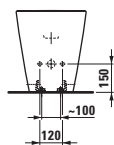
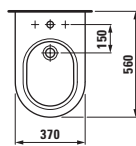

Colours ceramic

Keramikfarben
Couleurs céramique
Colori della ceramica





22233.2
Bathtub, freestanding
1760x760x540 mm, solid surface,
with slot overflow and tap bank
at feet side, with lifting system
Badewanne, freistehend
1760x760x540 mm, Mineral-
gusswerkstoff, mit Überlaufspalt
und Armaturenbank an der Fussseite,
mit Hubsystem
Baignoire, indépendante,
1760x760x540 mm, solid surface,
avec rainure de trop-plein et plage
de la robinetterie côté pieds, avec
système élévateur
Vasca indipendente
1760x760x540 mm, solid surface,
con troppopieno e banco rubinetteria
sul lato zoccolo, con sistema di
sollevamento

Options:
 .616 .627

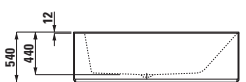
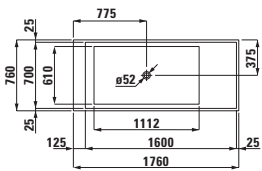

24333.1
Bathtub, drop-in
1700x860x590 mm, solid surface,
left corner, with tap bank, with
slot overflow at front side, with
frame
Badewanne, Einbauversion
1700x860x590 mm, Mineral-
gusswerkstoff, linke Ecke,
mit Armaturenbank, mit Überlaufspalt
in der Frontseite, mit Fussgestell
Baignoire, à encastrer par-dessus
1700x860x590 mm, solid surface,
angle à gauche, avec plage de la
robinetterie, avec rainure de trop-
plein sur le côté d'avant, avec tablier
Vasca da incasso
1700x860x590 mm, solid surface,
modello angolare sinistro, con banco
rubinetteria, troppopieno sul lato
frontale, con base

Options:
 .616 .627

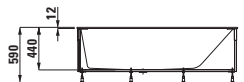
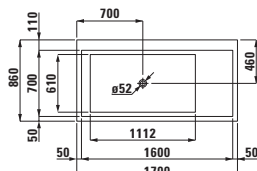

24333.2
Bathtub, freestanding
1700x860x540 mm, solid surface,
with tap bank, with slot overflow
at front side, with lifting system
Badewanne, freistehend
1700x860x540 mm, Mineral-
gusswerkstoff, mit Armaturenbank,
mit Überlaufspalt in der Frontseite,
mit Hubsystem
Baignoire, indépendante,
1700x860x540 mm, solid surface,
avec plage de la robinetterie, avec
rainure de trop-plein sur le côté
d'avant, avec système élévateur
Vasca indipendente
1700x860x540 mm, solid surface,
con banco rubinetteria, troppopieno
sul lato frontale, con sistema di
sollevamento

Options:
 .616 .627

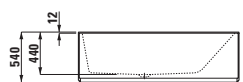
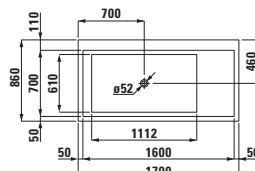

24333.6
Bathtub, left corner, with L-panel
right, 1700x860x590 mm, solid
surface, with tap bank, with slot
overflow at front side, with frame
Badewanne, linke Ecke,
mit L-Schürze rechts,
1700x860x590 mm, Mineral-
gusswerkstoff, mit Armaturenbank,
mit Überlaufspalt in der Frontseite,
mit Fussgestell
Baignoire, angle à gauche,
avec panneau en L à droite,
1700x860x590 mm, solid surface,
avec plage de la robinetterie, avec
rainure de trop-plein sur le côté
d'avant, avec tablier
Vasca, modello angolare sinistro,
con pannello a L a destra,
1700x860x590 mm, solid surface,
banco rubinetteria, troppopieno sul
frontale, con base

Options:
 .616 .627

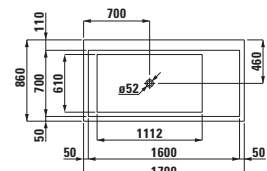



22333.1

Bathtub, drop-in

1700x860x590 mm, solid surface, right corner, with tap bank, with slot overflow at front side, with frame
 Badewanne, Einbauversion
 1700x860x590 mm, Mineralgusswerkstoff, rechte Ecke, mit Armaturenbank, mit Überlaufspalt in der Frontseite, mit Fussgestell
 Baignoire, à encastrer par-dessus
 1700x860x590 mm, solid surface, angle à droite, avec plage de la robinetterie, avec rainure de trop-plein sur le côté d'avant, avec tablier
 Vasca da incasso 1700x860x590 mm, solid surface, modello angolare destro, con banco rubinetteria, troppopieno sul lato frontale, con base

Options:

.616 .627

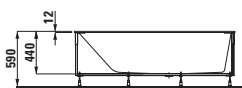
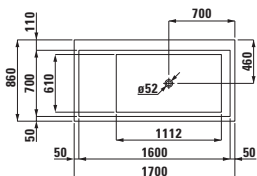

22333.2

Bathtub, freestanding,

1700x860x540 mm, solid surface, with tap bank, with slot overflow at front side, with lifting system
 Badewanne, freistehend,
 1700x860x540 mm, Mineralgusswerkstoff, mit Armaturenbank, mit Überlaufspalt in der Frontseite, mit Hubsystem
 Baignoire, indépendante,
 1700x860x540 mm, solid surface, avec plage de la robinetterie, avec rainure de trop-plein, avec système éleveur
 Vasca indipendente,
 1700x860x 540 mm, solid surface, con banco rubinetteria, troppopieno sul lato frontale, con sistema di sollevamento

Options:

.616 .627

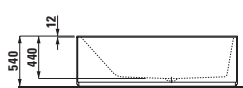
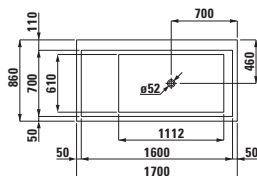

22333.5

Bathtub, right corner, with L-panel left, 1700x860x590 mm, solid surface, with tap bank, with slot overflow at front side, with frame

Badewanne, rechte Ecke, mit L-Schürze links,
 1700x860x590 mm, Mineralgusswerkstoff, mit Armaturenbank, mit Überlaufspalt in der Frontseite, mit Fussgestell
 Baignoire, angle à droite, avec panneau en L à gauche,
 1700x860x590 mm, solid surface, avec plage de la robinetterie, avec rainure de trop-plein sur le côté d'avant, avec tablier
 Vasca, modello angolare destro, con pannello a L a sinistra
 1700x860x590 mm, solid surface, banco rubinetteria, troppopieno sul lato frontale, con base

Options:

.616 .627

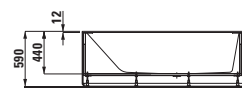
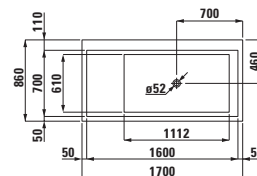

Versions bathtubs

Versionen Badewannen

Versiones des baignoires

Versioni delle vasche

- .616 With illuminated slot overflow**
 Mit beleuchtetem Überlaufspalt
 Avec rainure de trop-plein illuminée
 Con troppopieno illuminato
- .627 With illuminated slot overflow, with mist, with air massage**
 Mit beleuchtetem Überlaufspalt, mit Nebel, mit Luftmassage
 Avec rainure de trop-plein illuminée, avec aéromassage
 Con troppopieno illuminato, controllo dell'umidità, idromassaggio a getto d'aria

Colours bathtubs and shower trays

Farben Badewannen und

Duschwannen

Couleurs des baignoires et receveurs de douche

Colori delle vasche e dei piatti doccia

 **.000 White**

Weiss

Blanc

Bianco



Shower tray, rectangular, solid surface

Duschwanne, rechteckig, Mineralgusswerkstoff
Receveur de douche, rectangulaire, solid surface
Piatto doccia, rettangolare, solid surface

	A	B	C
21133.1	900	900	25
21233.1	1000	800	75
21233.2	1100	800	175
21233.3	1200	800	275
21233.4	1300	800	375
21233.5	1400	800	475

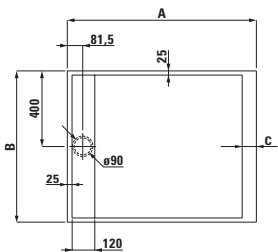

Vanity unit with space saving siphon for washbasin 81533.1

Waschtischunterbau mit platzsparendem Siphon für Waschtisch 81533.1
Meuble sous lavabo avec siphon compact pour lavabo 81533.1
Base sottolavabo, con sifone compatto per lavabo 81533.1

40750.1

With one drawer and internal shelf

Mit einer Schublade und Innenablage
Avec un tiroir et une tablette intérieure
Con un cassetto e mensola interna

40750.2

With two drawers

Mit zwei Schubladen
Avec deux tiroirs
Con due cassetti

Colours:

.631 .633 .634 .635 .636 .637

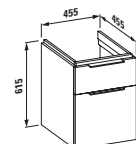



Vanity unit with space saving siphon

Waschtischunterbau mit platzsparendem Siphon
Meuble sous lavabo avec siphon compact
Base sottolavabo, con sifone compatto

40755.1

With one drawer and internal shelf for washbasin 81033.4 and 81033.5

Mit einer Schublade und Innenablage für Waschtisch 81033.4 und 81033.5
Avec un tiroir et une tablette intérieure pour lavabo 81033.4 et 81033.5
Con un cassetto e mensola interna per lavabo 81033.4 e 81033.5

40755.2

With two drawers for washbasin 81033.4

Mit zwei Schubladen für Waschtisch 81033.4
Avec deux tiroirs pour lavabo 81033.4
Con due cassetti per lavabo 81033.4

40756.2

With two drawers for washbasin 81033.5

Mit zwei Schubladen für Waschtisch 81033.5
Avec deux tiroirs pour lavabo 81033.5
Con due cassetti per lavabo 81033.5

Colours:

.631 .633 .634 .635 .636 .637

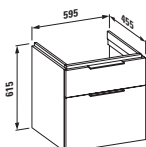

Vanity unit with space saving siphon for washbasin 81033.9

Waschtischunterbau mit platzsparendem Siphon für Waschtisch 81033.9
Meuble sous lavabo avec siphon compact pour lavabo 81033.9
Base sottolavabo, con sifone compatto per lavabo 81033.9

40760.1

With one drawer and internal shelf

Mit einer Schublade und Innenablage
Avec un tiroir et une tablette intérieure
Con un cassetto e mensola interna

40760.2

With two drawers

Mit zwei Schubladen
Avec deux tiroirs
Con due cassetti

Colours:

.631 .633 .634 .635 .636 .637

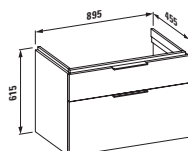

40752.0

Open shelf element

Offenes Regalelement
Élément de tablette ouvert
Elemento a giorno

40753.0

Glass cover plate, optional

Glasabdeckplatte, optional
Plaque de finition en verre, en option
Piano in vetro, optional

Colours:

.631 .633 .634 .635 .636 .637

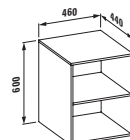

40762.0.033.004.1

Foot set (2 pieces)

Fuss-Set (2 Stück)
Set pied (2 pièces)
Set zoccolo (2 pz.)



Washtop

Waschtischplatte
Plan de toilette
Piano d'appoggio

40772.0

Without cut out

Ohne Ausschnitt
Sans découpe
Senza taglio

40772.1

With center cut out for washbasin bowl s1233.1

Mit Ausschnitt Mitte für Waschtisch-Schale s1233.1
Avec découpe centrale pour lavabo à poser s1233.1
Con taglio al centro per bacinella s1233.1

40772.2

With cut out left for washbasin bowl s1233.1

Mit Ausschnitt links für Waschtisch-Schale s1233.1
Avec découpe à gauche pour lavabo à poser s1233.1
Con taglio a sinistra per bacinella s1233.1

40772.3

With cut out right for washbasin bowl s1233.1

Mit Ausschnitt rechts für Waschtisch-Schale s1233.1
Avec découpe à droite pour lavabo à poser s1233.1
Con taglio a destra per bacinella s1233.1

40772.4

With cut out left and right for washbasin bowl s1233.1

Mit Ausschnitt links und rechts für Waschtisch-Schale s1233.1
Avec découpe à gauche et à droite pour lavabo à poser s1233.1
Con taglio a sinistra e a destra per bacinella s1233.1

Colours:

.631

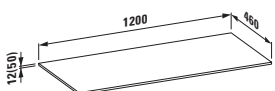

40773.1

With center cut out for washbasin bowl s1233.2

Mit Ausschnitt Mitte für Waschtisch-Schale s1233.2
Avec découpe centrale pour lavabo à poser s1233.2
Con taglio al centro per bacinella s1233.2

40773.2

With cut out left for washbasin bowl s1233.2

Mit Ausschnitt links für Waschtisch-Schale s1233.2
Avec découpe à gauche pour lavabo à poser s1233.2
Con taglio a sinistra per bacinella s1233.2

40773.3

With cut out right for washbasin bowl s1233.2

Mit Ausschnitt rechts für Waschtisch-Schale s1233.2
Avec découpe à droite pour lavabo à poser s1233.2
Con taglio a destra per bacinella s1233.2



Washtop

Waschtischplatte
Plan de toilette
Piano d'appoggio

40778.0

Without cut out

Ohne Ausschnitt
Sans découpe
Senza taglio

40778.1

With center cut out for washbasin bowl s1233.1

Mit Ausschnitt Mitte für Waschtisch-Schale s1233.1
Avec découpe centrale pour lavabo à poser s1233.1
Con taglio al centro per bacinella s1233.1

40778.2

With cut out left for washbasin bowl s1233.1

Mit Ausschnitt links für Waschtisch-Schale s1233.1
Avec découpe à gauche pour lavabo à poser s1233.1
Con taglio a sinistra per bacinella s1233.1

40778.3

With cut out right for washbasin bowl s1233.1

Mit Ausschnitt rechts für Waschtisch-Schale s1233.1
Avec découpe à droite pour lavabo à poser s1233.1
Con taglio a destra per bacinella s1233.1

40778.4

With cut out left and right for washbasin bowl s1233.1

Mit Ausschnitt links und rechts für Waschtisch-Schale s1233.1
Avec découpe à gauche et à droite pour lavabo à poser s1233.1
Con taglio a sinistra e a destra per bacinella s1233.1

Colours:

.631

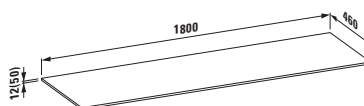

40779.1

With center cut out for washbasin bowl s1233.2

Mit Ausschnitt Mitte für Waschtisch-Schale s1233.2
Avec découpe centrale pour lavabo à poser s1233.2
Con taglio al centro per bacinella s1233.2

40779.2

With cut out left for washbasin bowl s1233.2

Mit Ausschnitt links für Waschtisch-Schale s1233.2
Avec découpe à gauche pour lavabo à poser s1233.2
Con taglio a sinistra per bacinella s1233.2

40779.3

With cut out right for washbasin bowl s1233.2

Mit Ausschnitt rechts für Waschtisch-Schale s1233.2
Avec découpe à droite pour lavabo à poser s1233.2
Con taglio a destra per bacinella s1233.2

40779.4

With cut out left and right for washbasin bowl s1233.2

Mit Ausschnitt links und rechts für Waschtisch-Schale s1233.2
Avec découpe à gauche et à droite pour lavabo à poser s1233.2
Con taglio a sinistra e a destra per bacinella s1233.2



40780.0

Drawer element with 12 mm top

Schubladenelement mit 12 mm

Platte

Élément de tiroir avec haut 12 mm

Elemento a cassetto con top da

12 mm

40782.0

Glass cover plate, optional

Glasabdeckplatte, optional

Plaque de finition en verre, en option

Piano in vetro, optional

Colours:

.631 .633 .634 .635 .636 .637

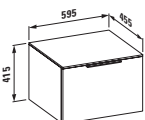
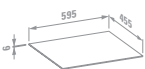

40785.0

Drawer element with 12 mm top

Schubladenelement mit 12 mm

Platte

Élément de tiroir avec haut 12 mm

Elemento a cassetto con top da

12 mm

40787.0

Glass cover plate, optional

Glasabdeckplatte, optional

Plaque de finition en verre, en option

Piano in vetro, optional

Colours:

.631 .633 .634 .635 .636 .637

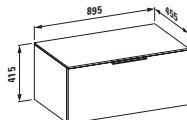

40790.0

Drawer element with 12 mm top

Schubladenelement mit 12 mm

Platte

Élément de tiroir avec haut 12 mm

Elemento a cassetto con top da

12 mm

40795.0

Glass cover plate, optional

Glasabdeckplatte, optional

Plaque de finition en verre, en option

Piano in vetro, optional

Colours:

.631 .633 .634 .635 .636 .637

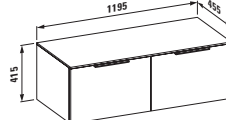



Drawer element with 12 mm top, with space saving siphon, with cut out left

Schubladenelement mit 12 mm Platte, mit platzsparendem Siphon, mit Ausschnitt links

Élément de tiroir avec haut 12 mm, avec siphon compact, avec découpe à gauche

Elemento a cassetto con top da 12 mm, con sifone compatto, con taglio a sinistra

40790.2

For washbasin bowl 81233.1

Für Waschtisch-Schale 81233.1

Pour lavabo à poser 81233.1

Per bacinella 81233.1

40795.2

Glass cover plate, optional

Glasabdeckplatte, optional

Plaque de finition en verre, en option

Piano in vetro, optional

40792.2

For washbasin 81533.1

Für Waschtisch 81533.1

Pour lavabo 81533.1

Per lavabo 81533.1

40797.2

Glass cover plate, optional

Glasabdeckplatte, optional

Plaque de finition en verre, en option

Piano in vetro, optional

Colours:

.631 .633 .634 .635 .636 .637

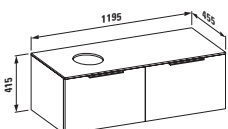
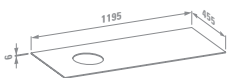

Drawer element with 12 mm top, with space saving siphon, with cut out right

Schubladenelement mit 12 mm Platte, mit platzsparendem Siphon, mit Ausschnitt rechts

Élément de tiroir avec haut 12 mm, avec siphon compact, avec découpe à droite

Elemento a cassetto con top da 12 mm, con sifone compatto, con taglio a destra

40790.3

For washbasin bowl 81233.1

Für Waschtisch-Schale 81233.1

Pour lavabo à poser 81233.1

Per bacinella 81233.1

40795.3

Glass cover plate, optional

Glasabdeckplatte, optional

Plaque de finition en verre, en option

Piano in vetro, optional

40792.3

For washbasin 81533.1

Für Waschtisch 81533.1

Pour lavabo 81533.1

Per lavabo 81533.1

40797.2

Glass cover plate, optional

Glasabdeckplatte, optional

Plaque de finition en verre, en option

Piano in vetro, optional

Colours:

.631 .633 .634 .635 .636 .637

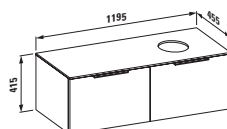



Drawer element with 12 mm top, with space saving siphon, with cut out left and right

Schubladenelement mit 12 mm Platte, mit platzsparendem Siphon, mit Ausschnitt links und rechts
 Élément de tiroir avec haut 12 mm, avec siphon compact, avec découpe à gauche et à droite
 Elemento a cassetto con top da 12 mm, con sifone compatto, con taglio a destra e a sinistra

40790.4

For washbasin bowl s1233.1

Für Waschtisch-Schale s1233.1
 Pour lavabo à poser s1233.1
 Per bacinella s1233.1

40795.4

Glass cover plate, optional

Glasabdeckplatte, optional
 Plaque de finition en verre, en option
 Piano in vetro, optional

40792.4

For washbasin s1533.1

Für Waschtisch s1533.1
 Pour lavabo s1533.1
 Per lavabo s1533.1

40797.4

Glass cover plate, optional

Glasabdeckplatte, optional
 Plaque de finition en verre, en option
 Piano in vetro, optional

Colours:

.631 .633 .634 .635 .636 .637

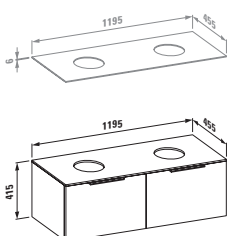

40800.0

Drawer element with 12 mm top

Schubladenelement mit 12 mm Platte
 Élément de tiroir avec haut 12 mm
 Elemento a cassetto con top da 12 mm

40805.0

Glass cover plate, optional

Glasabdeckplatte, optional
 Plaque de finition en verre, en option
 Piano in vetro, optional

Colours:

.631 .633 .634 .635 .636 .637

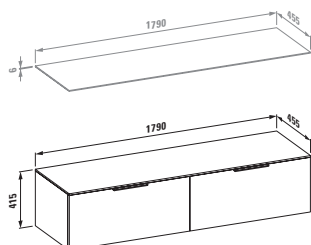

Drawer element with 12 mm top, with space saving siphon, with cut out left

Schubladenelement mit 12 mm Platte, mit platzsparendem Siphon, mit Ausschnitt links
 Élément de tiroir avec haut 12 mm, avec siphon compact, avec découpe à gauche
 Elemento a cassetto con top da 12 mm, con sifone compatto, con taglio a sinistra

40800.2

For washbasin bowl s1233.1

Für Waschtisch-Schale s1233.1
 Pour lavabo à poser s1233.1
 Per bacinella s1233.1

40805.2

Glass cover plate, optional

Glasabdeckplatte, optional
 Plaque de finition en verre, en option
 Piano in vetro, optional

40801.2

For washbasin s1233.2

Für Waschtisch s1233.2
 Pour lavabo s1233.2
 Per lavabo s1233.2

40806.2

Glass cover plate, optional

Glasabdeckplatte, optional
 Plaque de finition en verre, en option
 Piano in vetro, optional

Colours:

.631 .633 .634 .635 .636 .637

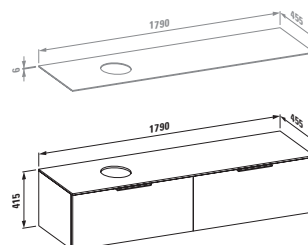

40802.2

For washbasin s1533.1

Für Waschtisch s1533.1
 Pour lavabo s1533.1
 Per lavabo s1533.1

40807.2

Glass cover plate, optional

Glasabdeckplatte, optional
 Plaque de finition en verre, en option
 Piano in vetro, optional

40803.2

For washbasin s1033.4 and s1033.5

Für Waschtisch s1033.4 und s1033.5
 Pour lavabo s1033.4 et s1033.5
 Per lavabo s1033.4 e s1033.5

40808.2

Glass cover plate, optional

Glasabdeckplatte, optional
 Plaque de finition en verre, en option
 Piano in vetro, optional

40804.2

For washbasin s1033.9

Für Waschtisch s1033.9
 Pour lavabo s1033.9
 Per lavabo s1033.9

40809.2

Glass cover plate, optional

Glasabdeckplatte, optional
 Plaque de finition en verre, en option
 Piano in vetro, optional



Drawer element with 12 mm top, with space saving siphon, with cut out right

Schubladenelement mit 12 mm Platte, mit platzsparendem Siphon, mit Ausschnitt rechts
 Élément de tiroir avec haut 12 mm, avec siphon compact, avec découpe à droite
 Elemento a cassetto con top da 12 mm, con sifone compatto, con taglio a destra

40800.3
For washbasin bowl s1233.1
 Für Waschtisch-Schale s1233.1
 Pour lavabo à poser s1233.1
 Per bacinella s1233.1

40805.3
Glass cover plate, optional
 Glasabdeckplatte, optional
 Plaque de finition en verre, en option
 Piano in vetro, optional

40801.3
For washbasin s1233.2
 Für Waschtisch s1233.2
 Pour lavabo s1233.2
 Per lavabo s1233.2

40806.3
Glass cover plate, optional
 Glasabdeckplatte, optional
 Piano in vetro, optional

Colours:
 .631 .633 .634 .635 .636 .637

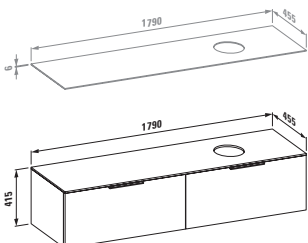

40802.3
For washbasin s1533.1
 Für Waschtisch s1533.1
 Pour lavabo s1533.1
 Per lavabo s1533.1

40807.2
Glass cover plate, optional
 Glasabdeckplatte, optional
 Plaque de finition en verre, en option
 Piano in vetro, optional

40803.3
For washbasin s1033.4 and s1033.5
 Für Waschtisch s1033.4 und s1033.5
 Pour lavabo s1033.4 et s1033.5
 Per lavabo s1033.4 e s1033.5

40808.2
Glass cover plate, optional
 Glasabdeckplatte, optional
 Plaque de finition en verre, en option
 Piano in vetro, optional

40804.3
For washbasin s1033.9
 Für Waschtisch s1033.9
 Pour lavabo s1033.9
 Per lavabo s1033.9

40809.2
Glass cover plate, optional
 Glasabdeckplatte, optional
 Piano in vetro, optional



Drawer element with 12 mm top, with space saving siphon, with cut out left and right

Schubladenelement mit 12 mm Platte, mit platzsparendem Siphon, mit Ausschnitt links und rechts
 Élément de tiroir avec haut 12 mm, avec siphon compact, avec découpe à gauche et à droite
 Elemento a cassetto con top da 12 mm, con sifone compatto, con taglio a destra e a sinistra

40800.4
For washbasin bowl s1233.1
 Für Waschtisch-Schale s1233.1
 Pour lavabo à poser s1233.1
 Per bacinella s1233.1

40805.4
Glass cover plate, optional
 Glasabdeckplatte, optional
 Plaque de finition en verre, en option
 Piano in vetro, optional

40801.4
For washbasin s1233.2
 Für Waschtisch s1233.2
 Pour lavabo s1233.2
 Per lavabo s1233.2

40806.4
Glass cover plate, optional
 Glasabdeckplatte, optional
 Piano in vetro, optional

Colours:
 .631 .633 .634 .635 .636 .637

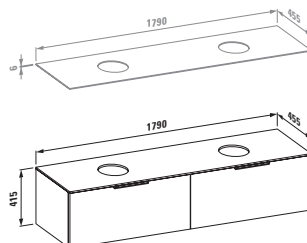

40802.4
For washbasin s1533.1
 Für Waschtisch s1533.1
 Pour lavabo s1533.1
 Per lavabo s1533.1

40807.4
Glass cover plate, optional
 Glasabdeckplatte, optional
 Plaque de finition en verre, en option
 Piano in vetro, optional

40803.4
For washbasin s1033.4 and s1033.5
 Für Waschtisch s1033.4 und s1033.5
 Pour lavabo s1033.4 et s1033.5
 Per lavabo s1033.4 e s1033.5

40808.4
Glass cover plate, optional
 Glasabdeckplatte, optional
 Plaque de finition en verre, en option
 Piano in vetro, optional



40810.0
Medium cabinet with mirror front and side open

Halbhochschrank mit Spiegelfront und offener Seite
Armoire mi-haute avec miroir à l'avant et ouverture latérale
Colonna media con frontale a specchio e lato a giorno

Colours:
 .631 .633 .634 .635 .636 .637

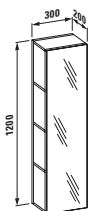

Tall cabinet
Hochschrank
Armoire haute
Colonna

40815.1
With one door left
Mit einer Tür links
Avec une porte à gauche
Con anta a sinistra

40815.2
With one door right
Mit einer Tür rechts
Avec une porte à droite
Con anta a destra

Colours:
 .631 .633 .634 .635 .636 .637

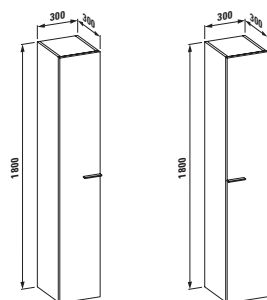

40820.3
Tall cabinet with two doors
Hochschrank mit zwei Türen
Armoire haute avec deux portes
Colonna a due ante

Colours:
 .631 .633 .634 .635 .636 .637

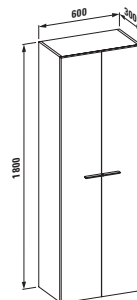

Colours furniture

Möbelfarben
Couleurs meubles
Colori dei mobili



.631 White glossy
Weiss glänzend
Blanc brillant
Bianco brillante



.634 Matt grey
Grau matt
Gris mat
Grigio opaco



.888 Extended furniture colours
Erweiterte Möbel-Farben
Couleurs meubles supplémentaire
Colori dei mobili supplementari

Please state colour number in the order text:

Bitte Farbnummer im Bestelltext angeben:
Veillez indiquer le numéro de couleur lors de la commande:
Indicare il codice colore nel testo dell'ordine:



Black glossy



Orange glossy



Plum glossy



Bordeaux glossy

All saints



38633.1
Mirror
Spiegel
Miroir
Specchio

Colours:
.081 .082 .084 .086 .087 .088

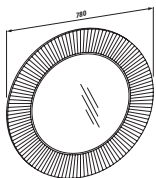

Max-Beam



38933.0
Stool
Hocker
Chaise
Sgabello

Colours:
.081 .082 .083 .084 .085

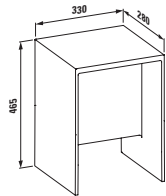

Sound-rack



38933.1
Rack
Regal
Rack
Rack

Colours:
.081 .082 .083 .084 .085

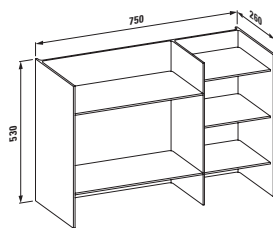

38533.1
Shelf for basin
Ablage für Waschtisch
Tablette pour lavabo
Mensola per lavabo

Colours:
.084 .085

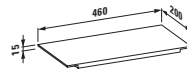

Shelfish



38533.0
Shelf wall-mounted
Ablage, wandmontiert
Tablette à montage mural
Mensola a parete

Colours:
.081 .082 .083 .084 .085



38533.2
Shelf for bathtub
Ablage für Badewanne
Tablette pour baignoire
Mensola per vasca

Colours:
.084 .085

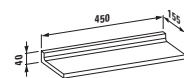
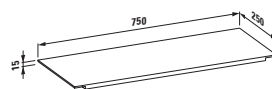

Rail



8133.0
Towel rail 300 mm
 Handtuchhalter 300 mm
 Porte-serviettes 300 mm
 Portasciugamani 300 mm

8133.1
Towel rail 450 mm
 Handtuchhalter 450 mm
 Porte-serviettes 450 mm
 Portasciugamani 450 mm

8133.2
Towel rail 600 mm
 Handtuchhalter 600 mm
 Porte-serviettes 600 mm
 Portasciugamani 600 mm

Colours:
 .081 .082 .083 .084 .085

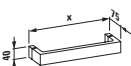

Ring Ring



8133.4
Towel ring
 Handtuchring
 Anneau à serviette
 Anello portasciugamani

Colours:
 .081 .082 .083 .084 .085



Rifly



8933.3
Pendant lamp 300 mm
 Hängeleuchte 300 mm
 Lampe assortie 300 mm
 Lampada a sospensione 300 mm

Colours:
 .084 .086 .087



Rifly



8933.4
Pendant lamp 600 mm
 Hängeleuchte 600 mm
 Lampe assortie 600 mm
 Lampada a sospensione 600 mm

Colours:
 .084 .086 .087



Rifly



8933.5
Pendant lamp 900 mm
 Hängeleuchte 900 mm
 Lampe assortie 900 mm
 Lampada a sospensione 900 mm

Colours:
 .084 .086 .087



Rifly



38933.2
Lamp wall-mounted
Lampe, wandmontiert
Lampe pour montage mural
Applique

Colours:
 .084 .086 .087

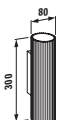

38533.3.004.000.1
Wall tray
Wandablage
Receveur mural
Mensolina portaoggetti

Including disc in colour
Transparent crystal
Beinhaltet disc in der Farbe
Kristallklar
Contient disc en couleur Transparent
cristal
Contiene disc in colore Trasparente
cristallo



38433.2.004.000.1
Toilet paper holder
Toilettenpapierhalter
Porte papier toilette
Portacarta igienica

Including disc in colour
Transparent crystal
Beinhaltet disc in der Farbe
Kristallklar
Contient disc en couleur Transparent
cristal
Contiene disc in colore Trasparente
cristallo



Colours accessories

Farben accessoires
Couleurs accessoires
Colori dei accessori



.081 Amber
Bernstein
Ambre
Ambra



.082 Tangerine orange
Mandarine
Orange tangerine
Arcancio tangerine



.083 Blue
Blau
Bleu
Blu



.084 Transparent crystal
Kristallklar
Transparent cristal
Trasparente cristallo



.085 Smoky grey
Rauchgrau
Fumé
Fumé



.086 Silver
Silber
Argent
Argento



.087 Gold
Gold
Or
Oro



.088 Gold plated 24K
Vergoldet 24K
Doré 24K
Dorato 24K

Discs in additional colours to be ordered separately:

Discs in zusätzlichen Farben separat
bestellbar:

Discs en couleur supplémentaire à
commander séparément:
Discs in colori supplementari da
ordinare separatamente:

Disc ø 183 mm

39833.5.081.001.1

Amber

Bernstein
Ambre
Ambra

39833.5.082.001.1

Tangerine orange

Mandarine
Orange tangerine
Arcancio tangerine

39833.5.084.001.1

Transparent crystal

Kristallklar
Transparent cristal
Trasparente cristallo

39833.5.085.001.1

Smoky grey

Rauchgrau
Fumé
Fumé

Disc ø 275 mm

39833.5.081.002.1

Amber

Bernstein
Ambre
Ambra

39833.5.082.002.1

Tangerine orange

Mandarine
Orange tangerine
Arcancio tangerine

39833.5.084.002.1

Transparent crystal

Kristallklar
Transparent cristal
Trasparente cristallo

39833.5.085.002.1

Smoky grey

Rauchgrau
Fumé
Fumé



31133.1.004.111.1

Washbasin mixer disc, fixed spout 110 mm, with pop-up waste

Waschtischmischer disc, Ausladung 110 mm, mit Ablaufventil
Mitigeur de lavabo disc, saillie 110 mm, avec vidage
Miscelatore per lavabo disc, sporgenza 110 mm, con piletta

31133.1.004.113.1

Washbasin mixer disc, fixed spout 110 mm, pop-up waste lever, without pop-up waste

Waschtischmischer disc, Ausladung 110 mm, mit Ablaufventilhebel, ohne Ablaufventil
Mitigeur de lavabo disc, saillie 110 mm, avec commande de vidage, sans vidage
Miscelatore per lavabo disc, sporgenza 110 mm, con leva di piletta, senza piletta

31133.1.004.110.1

Washbasin mixer disc, fixed spout 110 mm, without pop-up waste

Waschtischmischer disc, Ausladung 110 mm, ohne Ablaufventil
Mitigeur de lavabo disc, saillie 110 mm, sans vidage
Miscelatore per lavabo disc, sporgenza 110 mm, senza piletta

**Including disc in colour
Transparent crystal**

Beinhaltet disc in der Farbe Kristallklar
Contient disc en couleur Transparent cristal
Contiene disc in colore Trasparente cristallo

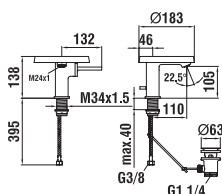

31133.8.004.110.1

Column basin mixer disc, fixed spout 110 mm, without pop-up waste

Standsäulen-Waschtischmischer disc, Ausladung 110 mm, ohne Ablaufventil
Mitigeur de lavabo sur colonne disc, saillie 110 mm, sans vidage
Miscelatore per lavabo a colonna disc alto, sporgenza 110 mm, senza piletta

**Including disc in colour
Transparent crystal**

Beinhaltet disc in der Farbe Kristallklar
Contient disc en couleur Transparent cristal
Contiene disc in colore Trasparente cristallo

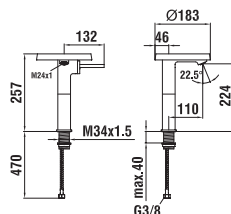

34133.1.004.111.1

Bidet mixer disc, with pop-up waste

Bidetmischer disc, mit Ablaufventil
Mitigeur de bidet disc, avec vidage
Miscelatore per bidet disc, con piletta

**Including disc in colour
Transparent crystal**

Beinhaltet disc in der Farbe Kristallklar
Contient disc en couleur Transparent cristal
Contiene disc in colore Trasparente cristallo

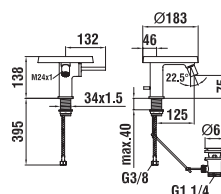

32133.1.004.121.1

Column bath mixer disc complete with synthetic flexible hose 1250 mm and handspray twinstick

Standsäulen-Bademischer disc komplett, mit Kunststoffschlauch 1250 mm und Handbrause twinstick
Mitigeur de bain sur colonne disc complet avec flexible synthétique 1250 mm et douchette twinstick
Miscelatore da bagno a colonna disc completo, con tubo sintetico 1250 mm e doccia twinstick

**Including disc in colour
Transparent crystal**

Beinhaltet disc in der Farbe Kristallklar
Contient disc en couleur Transparent cristal
Contiene disc in colore Trasparente cristallo

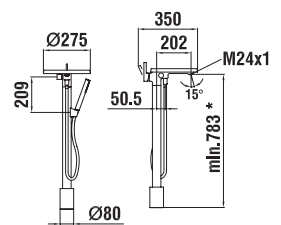



37098.5.000.000.1

Technical bloc for column bath mixer 32133.1.004.121.1

Rohbaukörper zu Standsäulen-Bademischer 32133.1.004.121.1
 Bloc technique pour mitigeur de bain sur colonne 32133.1.004.121.1
 Base di fissaggio per miscelatore per bagno a colonna 32133.1.004.121.1

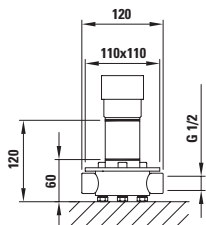

31233.3.004.221.1

Washbasin mixer 3-hole, swivel spout 166 mm, with pop-up waste

Waschtischmischer 3-Loch, Schwenkauslauf Ausladung 166 mm, mit Ablaufventil
 Mélangeur de lavabo 3-trous, goulot orientable saillie 166 mm, avec vidage
 Miscelatore per lavabo a 3 fori, bocca orientabile sporgenza 166 mm, con piletta

31233.3.004.220.1

Washbasin mixer 3-hole, swivel spout 166 mm, without pop-up waste

Waschtischmischer 3-Loch, Schwenkauslauf Ausladung 166 mm, ohne Ablaufventil
 Mélangeur de lavabo 3-trous, goulot orientable saillie 166 mm, sans vidage
 Miscelatore per lavabo a 3 fori, bocca orientabile sporgenza 166 mm, senza piletta

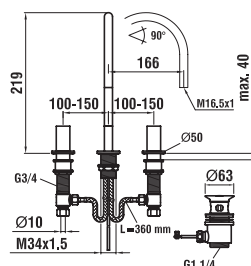

31233.6.004.120.1

Concealed washbasin wall mixer 2-handle, spout length 175 mm

UP-Wandmischer 2-Griff, Ausladung 175 mm
 Mélangeur de lavabo mural encastré, saillie 175 mm
 Miscelatore da incasso a 2 manopole, sporgenza 175 mm

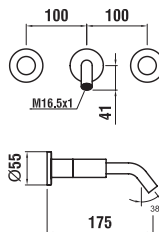

37698.2.000.100.1

Brass rough-in concealed set for concealed 2 handles basin mixer 31233.6.004.120.1

Messing Bausatz-Vormontage für 2-Griff UP-Waschtischmischer 31233.6.004.120.1
 Set de pré-montage en laiton à encastrier pour mélangeur 2 poignées de lavabo mural encastré 31233.6.004.120.1
 Set da incasso in ottone, per miscelatore da incasso a 2 manopole 31233.6.004.120.1

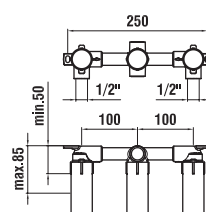

32233.5.004.282.1

Roman tub filler 5-holes, spout 173 mm, without plate

Wannenfüllkombination 5-Loch, Ausladung 173 mm, ohne Platte
 Garniture de remplissage de baignoire 5 trous, goulot 173 mm, sans plaque
 Bordo vasca 5 fori, sporgenza 173 mm, senza piastra

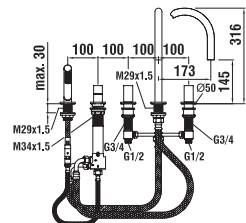

37133.0.004.060.1

Wall mounted fixed spout 175 mm

Wanneneinlauf, Ausladung 175 mm
 Goulot mural, saillie 175 mm
 Bocca di erogazione vasca, sporgenza 175 mm

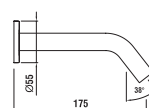



33133.7.004.141.1

Shower mixer 150 mm complete with synthetic flexible hose 1800 mm and twinstick handspray

*Duschenmischer 150 mm komplett mit Kunststoffschlauch 1800 mm und twinstick Handbrause
Mitigeur de douche 150 mm complet avec flexible synthétique 1800 mm et douchette twinstick
Miscelatore da doccia 150 mm completo con tubo sintetico 1800 mm e doccetta twinstick*

33133.7.004.400.1

Shower mixer 150 mm, with fittings, without accessories

*Duschenmischer 150 mm, mit Verschraubungen, ohne Zubehör
Mitigeur de douche 150 mm avec raccords, sans accessoires
Miscelatore da doccia 150 mm, con raccordi, senza accessori*

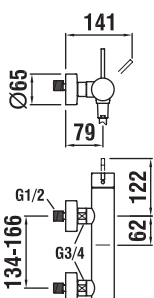

33133.7.004.142.1 (CH)

Shower mixer 153 mm complete with synthetic flexible hose 1800 mm and twinstick handspray

*Duschenmischer 153 mm komplett, mit Kunststoffschlauch 1800 mm und twinstick Handbrause
Mitigeur de douche 153 mm complet avec flexible synthétique 1800 mm et douchette twinstick
Miscelatore da doccia 153 mm completo con tubo sintetico 1800 mm e doccetta twinstick*

33133.7.004.002.1 (CH)

Shower mixer 153 mm, without fittings, without accessories

*Duschenmischer 153 mm, ohne Verschraubungen, ohne Zubehör
Mitigeur de douche 153 mm, sans raccords, sans accessoires
Miscelatore da doccia 153 mm, senza raccordi, senza accessori*

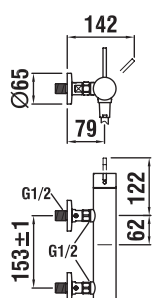

32133.6.004.000.1

Set for concealed bath/shower mixer Simibox, with diverter

*Fertigmontage-Set für UP-Bademischer Simibox, mit Umsteller
Habillage extérieur pour mitigeur de bain/douche encastré Simibox, avec inverseur
Set di montaggio per miscelatore da bagno ad incasso Simibox, con deviatore*

32133.6.004.010.1

Set for concealed bath/shower mixer Simibox, with diverter and vacuum breaker

*Fertigmontage-Set für UP-Bademischer Simibox, mit Umsteller und Sicherheitseinrichtung
Décor de mitigeur bain/douche Simibox, avec inverseur et avec anti-siphonnage
Set di montaggio per miscelatore da bagno ad incasso Simibox, con deviatore e dispositivo di sicurezza*

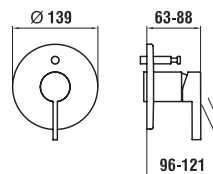

33133.6.004.000.1

Set for concealed shower mixer Simibox

*Fertigmontage-Set für UP-Duschenmischer Simibox
Habillage extérieur pour mitigeur de douche encastré Simibox
Set di montaggio per miscelatore da doccia ad incasso Simibox*

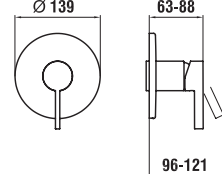

37898.0.000.000.1

Simibox concealed installation block for bath and shower mixer

*Simibox Unterputz-Einbaukörper für Bade- und Duschenmischer
Corps encastré Simibox pour mitigeur de baignoire et de douche
Corpo ad incasso Simibox per miscelatore da doccia e da bagno*

37998.0.003.000.1

Mounting aid for Simibox

*Montagehilfe für Simibox
Aide de montage pour Simibox
Ausilio di montaggio per Simibox*

37998.0.000.500.1

Flange for Simibox

*Flansch für Simibox
Bride pour Simibox
Flangia per Simibox*

37998.0.000.050.1

Extension set L = 25 mm

*Verlängerungsset L = 25 mm
Set de rallonge L = 25 mm
Prolunga L = 25 mm*

37998.0.000.060.1

Extension set L = 50 mm

*Verlängerungsset L = 50 mm
Set de rallonge L = 50 mm
Prolunga L = 50 mm*

Types of washbasins

Ausführungen Waschtische

Exécutions lavabos

Modelli lavabi

.104 1 tap hole

- 1 Hahnloch
1 trou pour la robinetterie
1 foro per la rubinetteria

.108 3 tap holes

- 3 Hahnlöcher
3 trous pour la robinetterie
3 fori per la rubinetteria

.111 1 tap hole, without overflow

- 1 Hahnloch, ohne Überlauf
1 trou pour la robinetterie,
sans trop-plein
1 foro per la rubinetteria,
senza troppopieno

.112 Without tap hole, without overflow

- Ohne Hahnloch, ohne Überlauf
Non percé, sans trop-plein
Senza foro per la rubinetteria,
senza troppopieno

.158 3 tap holes, without overflow

- 3 Hahnlöcher, ohne Überlauf
3 trous pour la robinetterie,
sans trop-plein
3 fori per la rubinetteria,
senza troppopieno



It is possible that not all products, sizes or colours are available in every country. Delivery periods may also differ in each case.

Unter Umständen sind nicht alle Produkte, Grössen oder Farben in jedem Land verfügbar. Auch die jeweiligen Lieferzeiten können von Land zu Land abweichen.

Il se peut que les produits ne soient pas tous disponibles dans chaque pays dans toutes les dimensions et coloris. Les délais de livraisons peuvent également varier d'un pays à l'autre.

È possibile che non tutti i prodotti, le misure e i colori siano ugualmente disponibili in ogni Paese. Anche i tempi di consegna possono variare da un Paese all'altro.

The illustrated colours only approximately correspond to the actual shades. The bathroom layouts shown here are purely decorative and do not reflect all the technical requirements. The decorative parts used are not included in our commercial offer. We reserve the right to make technical changes without prior notice. Registered design.

Die Farbabbildungen entsprechen nur in etwa den tatsächlichen Farbtönen. Die hier gezeigten Badmilieus sind rein dekorativ und berücksichtigen nicht alle technischen Anforderungen. Unser Angebot beinhaltet nicht die verwendete Dekoration. Technische Änderungen sind vorbehalten. Design geschützt.

Les photos couleur ne correspondent que partiellement aux teintes effectives. Les ambiances reproduites ici sont simplement décoratives, les exigences techniques d'installation n'ont pas toujours été prises en compte. La décoration utilisée ne fait pas partie de notre offre commerciale. Sous réserve de modifications techniques. Modèle déposé.

I colori qui illustrati non corrispondono esattamente alle tonalità effettive. Gli ambienti qui riprodotti sono puramente decorativi e non tengono conto di tutte le specifiche tecniche. Gli articoli d'arredo usati non fanno parte della nostra offerta commerciale. Con riserva di apportare modifiche tecniche. Modello depositato.

Products with the Q-Plus certification comply with the European standard, as well as with the proven higher Swiss standard laid down by suissetec/VSA. LAUFEN ceramic products comply with this Swiss quality standard and are recommended accordingly.

Produkte mit der Q-Plus-Zertifizierung entsprechen einerseits der Europannorm und andererseits zusätzlich dem bewährten, höheren Schweizer Standard, welcher durch die suissetec/VSA festgelegt wurde. LAUFEN Keramikprodukte entsprechen diesen schweizerischen Qualitätsmassstäben und haben die entsprechende Zulassungsempfehlung.

Les produits avec certification Q-Plus correspondent à la norme européenne et satisfont en plus aux standards suisses définis par la suissetec/VSA, encore plus élevés et qui ont largement fait leurs preuves. Les produits en céramique signés LAUFEN sont conformes à ces critères de qualité suisses et bénéficient donc des recommandations d'homologation correspondantes.

I prodotti con la certificazione Q-Plus sono conformi sia alla normativa europea sia allo standard svizzero, che prevede requisiti ancora più rigorosi, stabiliti dalla suissetec/VSA. I prodotti in ceramica LAUFEN rispettano questi criteri qualitativi svizzeri e dispongono della relativa certificazione di qualità.

Printed on certified paper from sustainably managed forests.

Gedruckt auf zertifiziertem Papier. Aus nachhaltig bewirtschafteten Wäldern.

Imprimé sur du papier certifié. Issu de forêts exploitées de façon durable.

Stampato su carta certificata. Proveniente da boschi a gestione sostenibile.

Headquarters:

LAUFEN Bathrooms AG
Wahlenstrasse 46
CH-4242 Laufen
Tel. +41 61 765 71 11
Fax +41 61 761 36 60
feedback@laufen.ch
www.laufen.com

Export:

LAUFEN Bathrooms AG
Wahlenstrasse 46
CH-4242 Laufen
Tel. +852 250 624 09
Fax +41 61 765 77 77
export@laufen.ch
www.laufen.com/export

Asia:

Roca Sanitaryware Ltd.
Room 2303, 23/F
148 Electric Road
North Point, Hong Kong
Tel. +852 250 624 38
Fax +852 250 624 92
laufenasia@hongkong.laufen.ch
www.laufen.com/export

Australia, New Zealand and Oceania:

ROCA Bathroom Products
Australia P/L
Suite 304, Level 3
191 Clarence Street
Sydney, 2000
NSW, Australia
Tel. +61 (2) 9290 2331
Fax +61 (2) 9290 2786
josep.royo@roca.net
www.laufen.com.au

Austria:

LAUFEN Austria AG
Mariazeller Strasse 100
A-3150 Wilhelmsburg
Tel. +43 2746 6060
Fax +43 2746 6060 380
office.wi@at.laufen.com
www.laufen.co.at

Bosnia Herzegovina, Croatia, Kosovo, Macedonia, Montenegro, Serbia, Slovenia:

INKER d.d.
Industrijska 1
10290 Zaprešić
Tel. +385 1 3310 364
Fax +385 1 3310 275
info@inker.hr
www.laufen.com

Benelux:

LAUFEN Benelux B.V.
Meidoorinkade 2A
NL-3992 AE Houten
Tel. +31 (0)33 450 20 90
Fax +31 (0)33 450 20 91
info.benelux@laufen.ch
www.laufen.nl
www.laufen.be

Brazil:

Roca Sanitários Brasil Ltda.
Av. 14 de Dezembro,
2.800 - V. Mafalda
CEP: 13206-105
Jundiaí - SP - Brasil
Tel. Adm. Vendas: +55 11 3378-4827
Assistência Técnica: 0800 70 11 510
Fax +55 11 4587-2324
info.br@laufen.com
www.laufen.com/br

Bulgaria:

Roca Bulgaria AD
5, Pirotka Str.
1301 Sofia, Bulgaria
Tel. +359 29 30 59 10
Fax +359 02 93 59 18
office.sofia@bg.roca.net
www.roca.com

China:

Roca Sanitary Trading
(Shanghai) co. Ltd
Room 503-505, City Gateway
No. 396 North Caoxi Road
Shanghai 200030, China
Tel. +86 21 3368 8822
Fax +86 21 3368 8299
laufen_cn@roca.net.cn
www.cn.laufen.com

Czech Republic:

LAUFEN CZ s.r.o.
V Tûních 3/1637
120 00 Praha 2
Tel. +420 296 337 711
Fax +420 296 337 713
galerie@cz.laufen.com
www.laufen.cz

Estonia, Latvia:

LAUFEN CZ s.r.o.
Pae 25-8
Tallinn, 11414
Estonia
Tel./Fax +372 6 215 569
office.tallinn@ee.laufen.com
www.laufen.com

France:

LAUFEN France
19-21, rue de Bretagne
Z.I. des Béthunes
F-95310 St-Ouen-L'Aumône
Tel. +33 1 34 40 39 31
Fax +33 1 30 37 02 65
commercial@laufen-france.com
www.laufen.com/fr

Germany:

Roca GmbH
Vertrieb LAUFEN
Feincheswiese 17
56424 Staudt
Tel. +49 26 02 / 94 93 33
Fax +49 26 02 / 94 93 355
info.staudt@de.laufen.com
www.de.laufen.com

Hungary:

LAUFEN CZ s.r.o.
Hungarian Trade Agency
Pasaréti u. 83
H-1026 Budapest
Tel. +36 1 274 05 35
Fax +36 1 391 04 58
office.budapest@hu.laufen.com
www.laufen.com

India:

Roca Bathroom Products Pvt. Ltd.
3rd Floor, Tower B,
DLF Building No. 10, Phase – II
DLF Cyber City,
Gurgaon – 122002, Haryana
India
Tel. +91 124 4278347-49
Fax +91 124 4278350
Info.laufen@in.roca.com
www.laufen.com/export

Italy:

LAUFEN Italia s.r.l.
via G. Matteotti, 157
I-20082 Binasco (MI)
Tel. +39 02 900 16 01
Fax +39 02 905 22 19
info@laufen.it
www.laufen.it

Lithuania:

LAUFEN CZ s.r.o.
Užupio g. 30
Vilnius, 01203
Lietuva
Tel. +370 5 215 30 76
Fax +370 5 215 30 86
office.vilnius@lt.laufen.com
www.laufen.lt

Morocco:

Roca Maroc, S.A.
route de Marrakech, km 2,5
BP 571, 26000 Settât
Tel. +212 5 23 40 59 41
Fax +212 5 23 40 59 42
www.roca.com

Nordic countries:

Laufen Nordic ApS
Torvet 15, Baghuset
DK-4600 Koge
Tel. +45 56 287 287
Fax +45 56 287 237
info@dk.laufen.com
www.laufen.dk
www.laufen.fi
www.laufen.no
www.laufen.se

North America:

Laufen Bathrooms North America
11190 NW 25th Street
Miami, FL 33172
USA
Toll free phone +1 (866) 696-2493
+1 (305) 357-6130
Toll free fax +1 (866) 264-7622
usa@laufen.com
canada@laufen.com
www.laufen.com/usa
www.laufen.com/ca
www.laufen.com.mx

Poland:

Roca Polska Sp. z o.o.
ul. Wyczkówskiego 20
44-109 Gliwice
Tel. +48 32 339 41 00
Fax +48 32 339 41 01
biuro@roca.pl
www.laufen.pl

Portugal:

Roca, S.A., Portugal
Apartado 575, Ponte da Madalena
2416-905 - Leiria, Portugal
Tel. +351 244 720 000
Fax +351 244 722 373
marketing.le@pt.roca.net
www.laufen.pt

Romania:

Roca Obiecte Sanitare S.R.L.
Blvd. Preciziei nr. 1, Sector 6
062202 - Bucharest - Romania
Tel. +4031 822 2310
Fax +4021 318 1418
www.laufen.com

Russia:

Roca Rus
Promyshlennaya Str. 7, Tosno
Leningrad region, 187000, Russia
Tel. +7 812 347 94 49
Fax +7 812 347 94 50
marketing@ru.roca.net
www.laufen.ru

Roca Rus

2nd Hutorskaya, 38A, building 14
Moscow, 127287, Russia
Tel. +7 495 989 65 91
Fax +7 495 959 65 93
marketing@ru.roca.net
www.laufen.ru

Slovakia:

LAUFEN SK s.r.o.
Štefanovičova 12
811 04 Bratislava
Tel. +421 2 526 210 24
Fax +421 2 526 210 25
office.bratislava@sk.laufen.com
www.laufen.sk

Spain:

LAUFEN Bathrooms S.A.
Paseo de la Castellana 98
28046 Madrid
España
Tel./Fax 900 103 258 – free call
info@es.laufen.com
www.laufen.com/es

Switzerland:

Keramik Laufen AG
Wahlenstrasse 46
CH-4242 Laufen
Tel. +41 61 765 71 11
Fax +41 61 761 29 22
forum@laufen.ch
www.laufen.ch

Ukraine:

LAUFEN CZ s.r.o. Ukraine
Kiev 04128
19, Ak. Tupoleva str., office „Laufen“
Tel. +380 44 499 0620
Fax +380 44 499 0621
office.kiev@ua.laufen.com
www.laufen.net.ua

United Kingdom and Ireland:

LAUFEN Ltd.
c/o Roca Ltd.
Samson Road
Hermitage Industrial Estate
Coalville
Leicestershire
LE67 3FP
Tel. +44 (0)1530 510007
Fax +44 (0)1530 838949
info@uk.laufen.com
www.laufen.co.uk





CONCEPT, GRAPHICS & STYLING: PS+A /
PHOTOS: ADRIANO BRUSAFERRI _PRINT: GRAFICHE ANTIGA

THANKS TO:
BRIX _ IL CASONE _ COTÉ BASTIDE _ DE VECCHI MILANO 1935 _ G.T. DESIGN _
IVANO REDAELLI _ KENZOKI _ KOHRO _ LUDOVICO MARTELLI SRL _ MARIANNAUD
PARFUMERIES ITALIA _ MARTINI SPA _ PROFUMUM ROMA _ SOCIETY _ TEIXIDORS



Kartell by **LAUFEN**

kartell.it / laufen.com

INNOVATION



Kartell[®] by LAUFEN

SaphirKeramik™



A HIGH-TECH MATERIAL /at the core of new design



A REVOLUTION IN THE FORMAL LANGUAGE OF CERAMICS

The innovative and high-quality composition of SaphirKeramik bestows possibilities and versatility never seen before upon the base material, enabling exceptional shaping. Edge radii of 1–2 mm are thus technically feasible.

The new type of ceramic is considerably harder and has an improved bending strength. LAUFEN is thus able to produce thinner ceramic bodies, which reduces weight and the consumption of raw materials and energy. SaphirKeramik is not a replacement for any of the existing materials; instead, it broadens the range of forms of expression of the natural base material.

EINE REVOLUTION IN DER FORMENSPRACHE VON KERAMIK

Die innovative und wertvolle Rezeptur von SaphirKeramik gibt dem Ausgangsmaterial noch nie da gewesene Möglichkeiten und Spielräume in der Formgestaltung. Kantenradien von 1–2 mm sind somit technisch machbar.

Die neue Keramik ist deutlich härter und hat eine grössere Biegefestigkeit. LAUFEN produziert so dünnere keramische Körper und reduziert damit das Gewicht sowie den Rohstoff- und Energieverbrauch. Die SaphirKeramik ersetzt keine der bestehenden Rezepturen, sondern erweitert das Spektrum der Ausdrucksformen des natürlichen Materials.

UNA RIVOLUZIONE NELLA FORMA DELLA CERAMICA

L'innovativa e pregiata ricetta di SaphirKeramik permette libertà d'azione e possibilità finora impensate di configurazione della ceramica. In questo modo diventa finalmente possibile dal punto di vista tecnico ottenere raggi di soli 1–2 mm.

Questo nuovo tipo di ceramica è notevolmente più duro, e possiede una maggiore resistenza alla flessione. In questo modo LAUFEN riesce a produrre corpi in ceramica più sottili, riducendone il peso e contribuendo a risparmiare il consumo di energia e di materie prime. SaphirKeramik non sostituisce le ricette esistenti, ma amplia la gamma delle forme espressive del materiale naturale.

UNE RÉVOLUTION DU LANGAGE FORMEL DE LA CÉRAMIQUE

La formulation innovante et de grande valeur de la SaphirKeramik offre des opportunités et marges d'un tout nouveau genre pour la conception des formes. Il est ainsi possible de réaliser des bords avec un rayon de 1 à 2 mm.

La nouvelle céramique est nettement plus dure et résistante à la flexion. LAUFEN produit ainsi des corps en céramique plus fins et réduit donc le poids ainsi que la consommation de matières premières et d'énergie. La SaphirKeramik ne remplace aucune des formulations existantes, mais complète les formes d'expression du matériau naturel.

HIDDEN DRAIN WITH /optional hidden overflow

Kartell by Laufen is breaking the mould when it comes to drain design. The new washbasins in the Kartell by Laufen collection have no visible drainage opening. The water disappears into a narrow, hidden drain through an elegant line. A concealed overflow system has also been developed. A special valve allows you to choose between a solution which is always open or which can be closed off.

Kartell by Laufen geht neue Wege im Ablaufdesign. Die neuen Waschtische der Serie Kartell by Laufen kommen ohne sichtbare Ablauföffnung aus. Das Wasser verschwindet, geführt durch eine elegante Linie, in einen schmalen, verdeckten Ablauf. Darüber hinaus wurde eine versteckte Überlauffunktion entwickelt. Damit kann mittels eines speziellen Ventils zwischen einer immer offenen oder einer staubaren Lösung gewählt werden.

Kartell by Laufen percorre nuove strade nella progettazione degli scarichi. I nuovi lavabi della serie Kartell by Laufen possiedono un'apertura di scarico invisibile. L'acqua scompare, seguendo una linea elegante, in un sottile scarico nascosto.

È stata inoltre messa a punto una funzione antitraboccamento nascosta. Grazie ad una speciale valvola, è possibile in questo modo scegliere tra due modalità: sempre aperto o bloccabile.

Le nouveau concept d'écoulement Kartell by Laufen sort des sentiers battus. Les nouveaux lavabos de la série Kartell by Laufen sont fabriqués sans écoulement visible. L'eau, guidée par une ligne élégante, disparaît dans un écoulement fin recouvert. Par ailleurs, une fonction invisible a été développée pour le trop-plein. Une vidage spéciale permet ici de choisir entre une solution ouverte et une solution à encombrement réduit.

LAUFEN EASYFIT FIXATION

LAUFEN has developed a revolutionary wall fixation system for WCs, bidets and urinals. A patent has been lodged. The invisible, easy to mount fixation system meets the needs of both fitters and end users.

For example, end users are impressed by a ceramic WC with a flawless surface which is really easy to clean since there's nowhere for dirt to hide. Fitters are enthusiastic about the time-saving, intuitive mounting system.

LAUFEN hat eine revolutionäre Wandbefestigung für WCs, Bidets und Urinale entwickelt und zum Patent angemeldet. Diese unsichtbare und einfach zu montierende Befestigung entspricht den Bedürfnissen von Installateuren und Endanwendern gleichermaßen.

Die Endanwender freuen sich z.B. über ein Keramik-WC, dessen makellose Oberfläche sich mühelos reinigen lässt, da der Schmutz keinen Halt in Nischen findet. Die Installateure begeistern sich für das zeitsparende, selbsterklärende Montagesystem von unten.

LAUFEN ha messo a punto un rivoluzionario sistema di fissaggio a parete (in fase di brevetto) per vasi, bidet ed orinatoiri. Questo sistema di fissaggio invisibile e facile da montare soddisfa in egual misura le esigenze degli installatori e degli utenti finali.

L'utente finale sarà sicuramente soddisfatto di un vaso in ceramica estremamente facile da pulire, in quanto la sporcizia non riesce ad aderire nelle nicchie. Gli installatori invece apprezzeranno la possibilità di risparmiare tempo con questo sistema di montaggio autoesplicativo dal basso.

LAUFEN a développé une fixation murale révolutionnaire pour WC, bidet et urinoirs et a déposé un brevet pour celle-ci. Cette fixation facile à monter et invisible satisfait aux exigences des installateurs et de l'utilisateur final.

L'utilisateur final apprécie par ex. d'avoir acheté un WC en céramique, dont la surface irréprochable se nettoie sans peine, étant donné que la saleté n'adhère plus dans les coins. Les installateurs apprécient le système de montage rapide et intuitif.





_removable disc

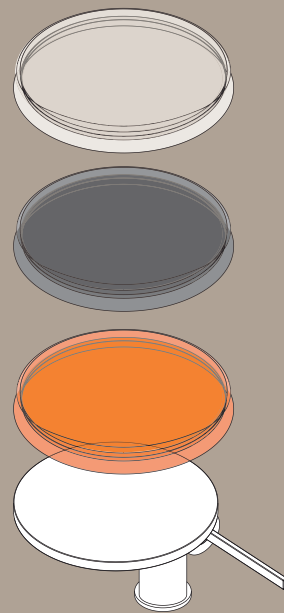
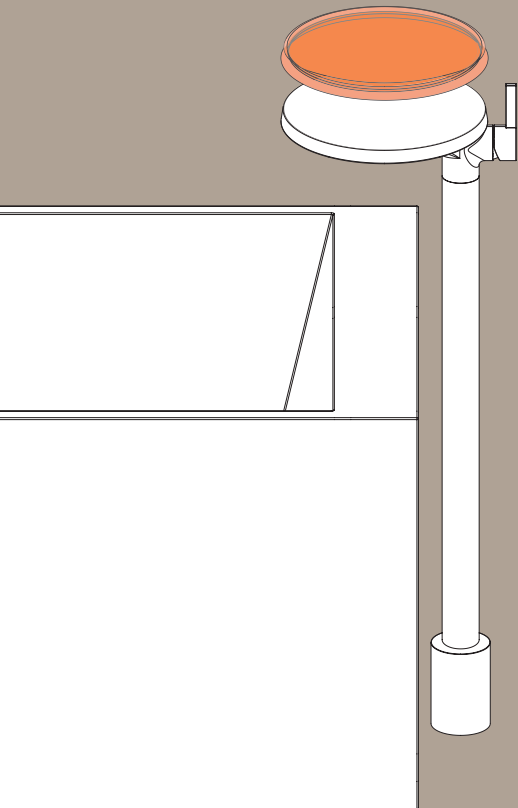

AESTHETIC & FUNCTIONALITY

/everyday emotions for the body and the mind

*water level with
overflow innovation*

*water level with
regular overflow*

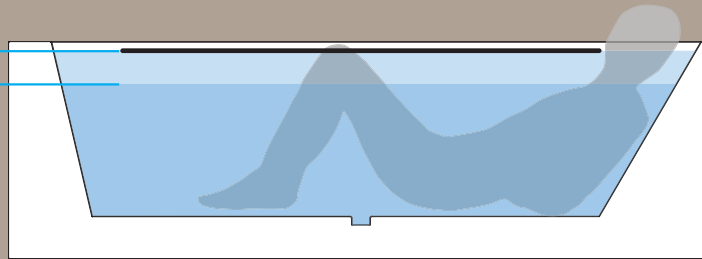

/infinity overflow
/mist system
/LED ambient light
/air massage experience

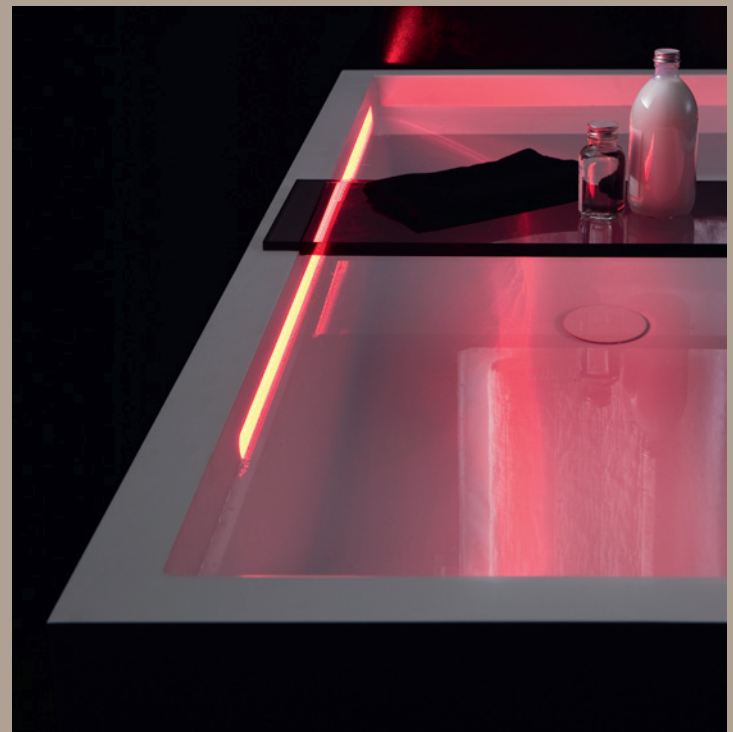
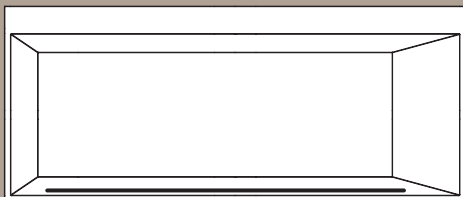
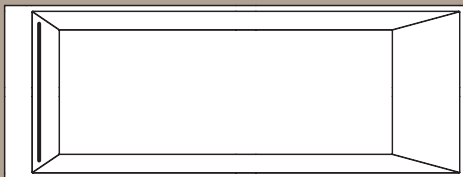

_LAMPS

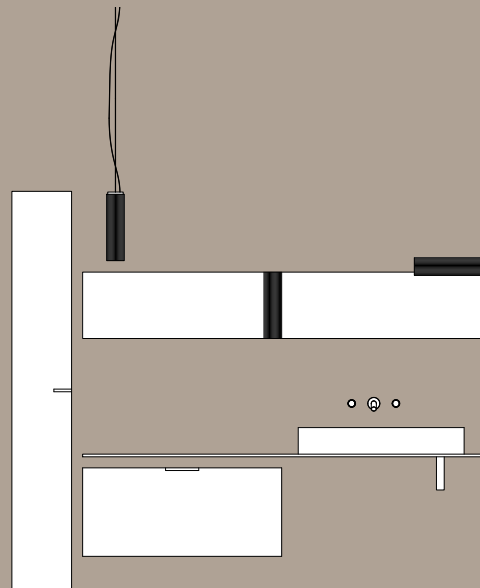
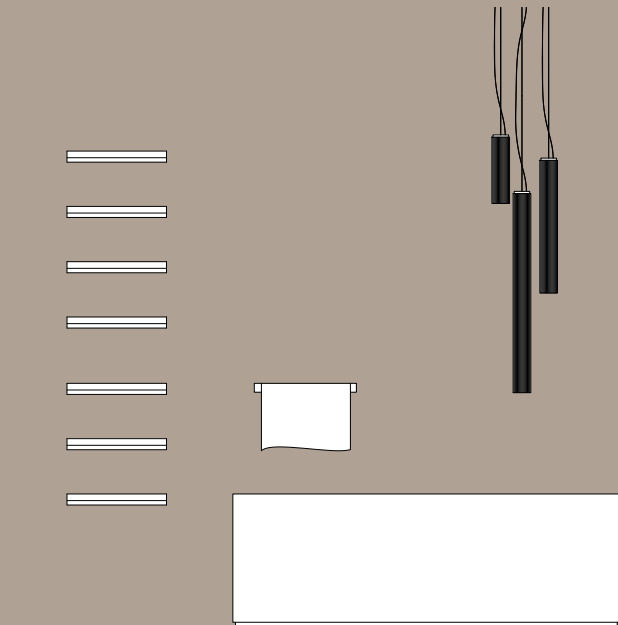
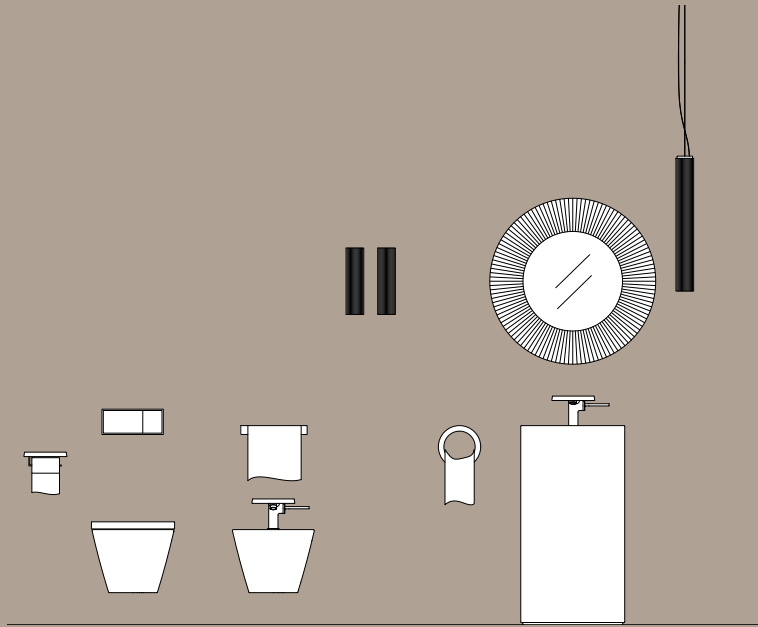

FURNITURE COMBINATIONS

/many configurations for
your own space

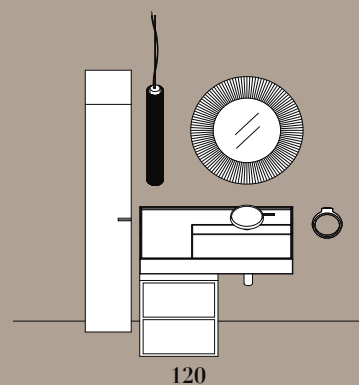
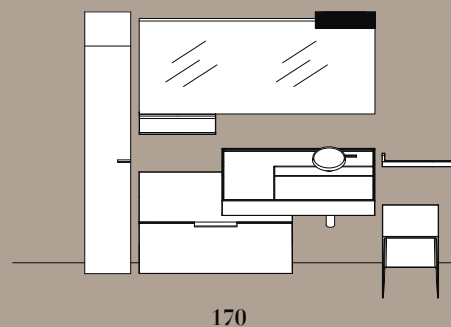
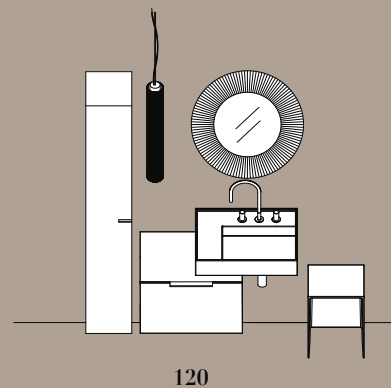
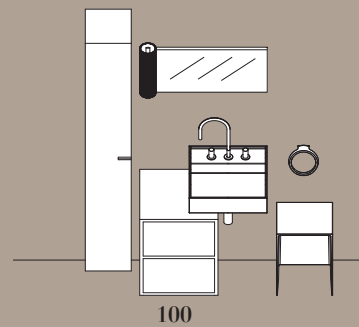

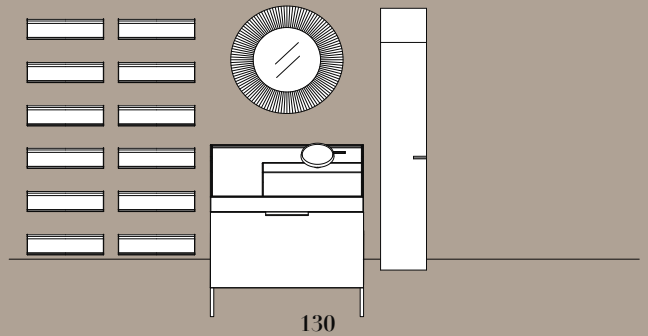
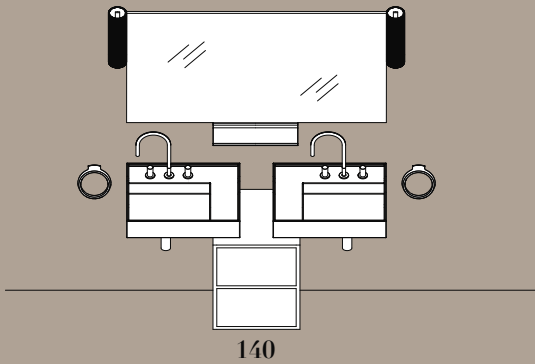
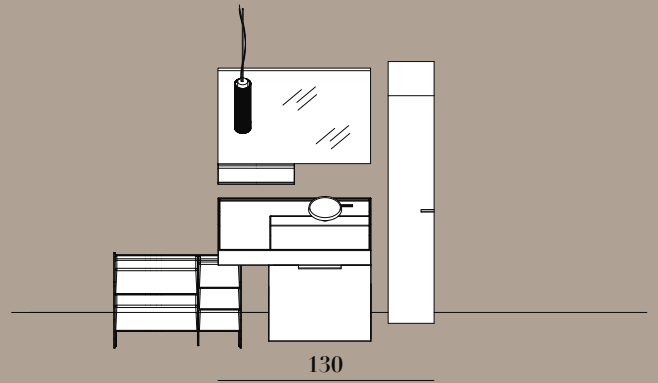
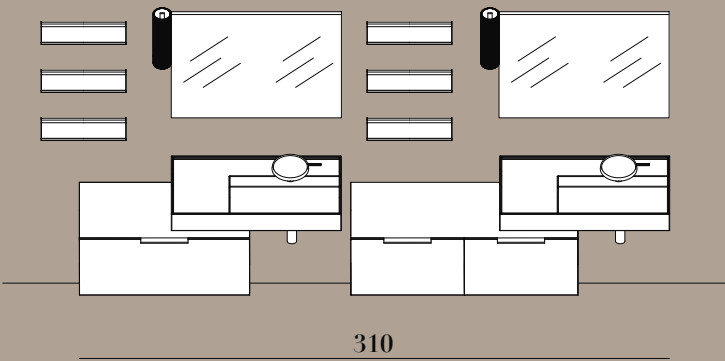
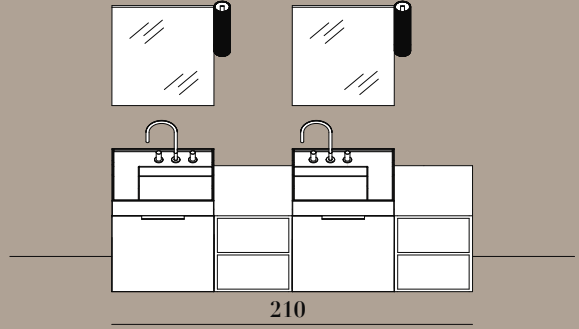
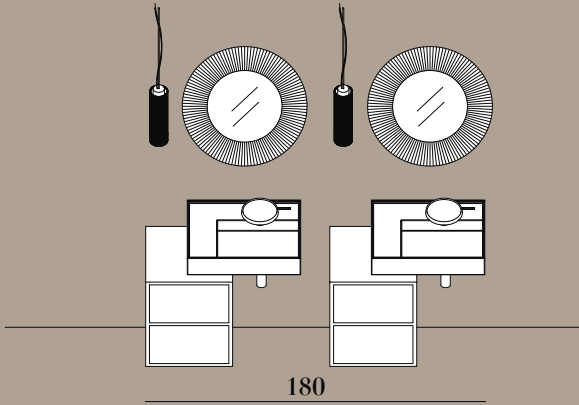
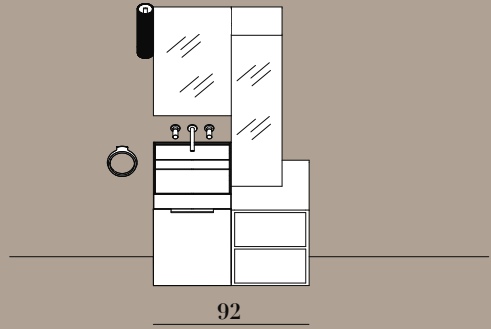
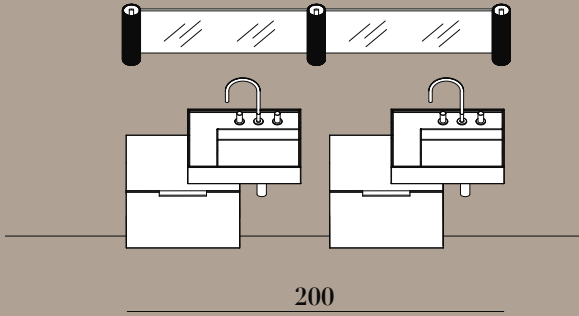

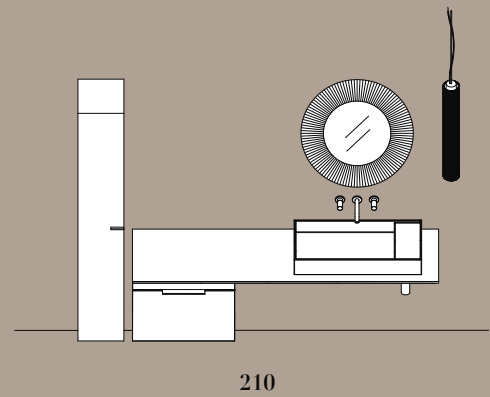
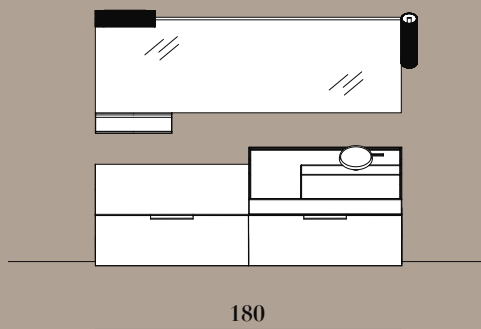
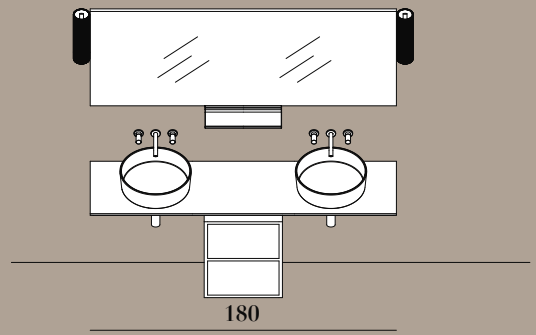
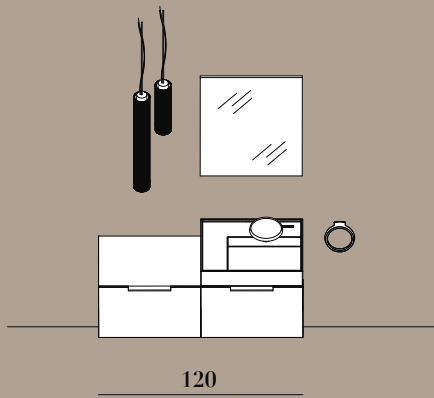
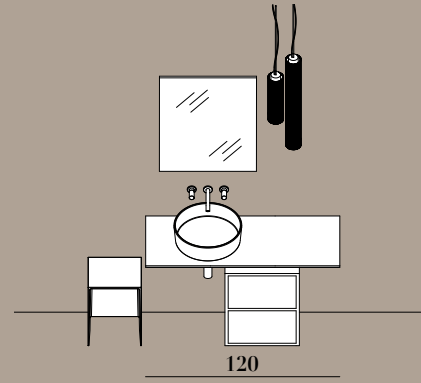
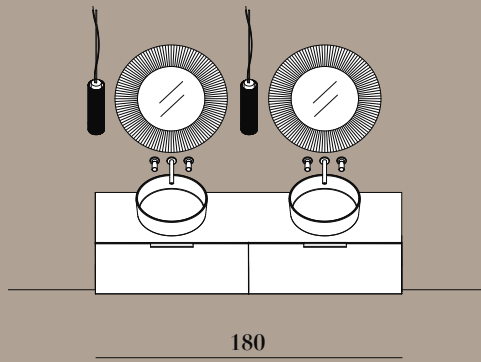
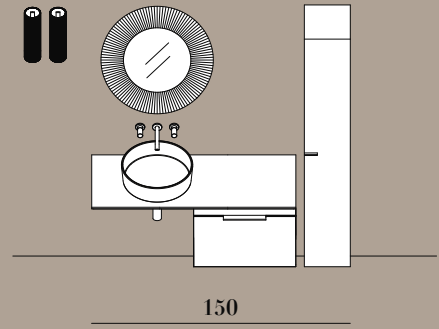
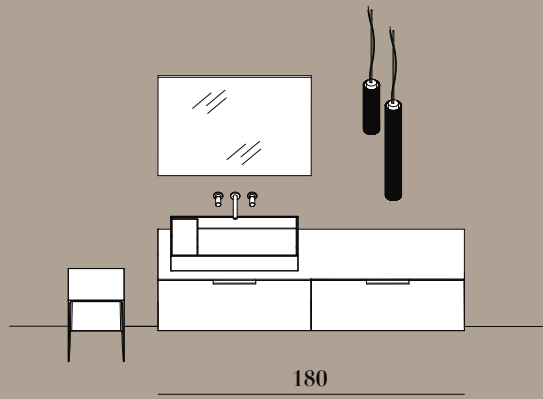



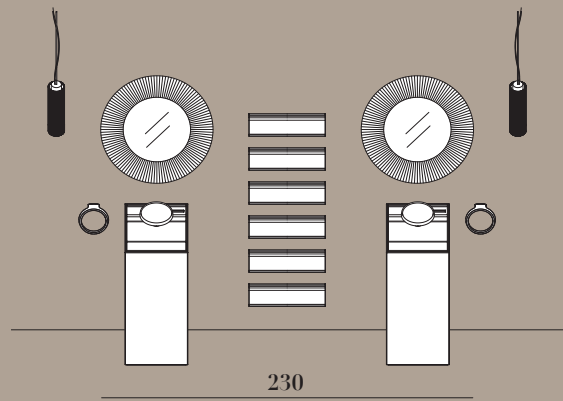
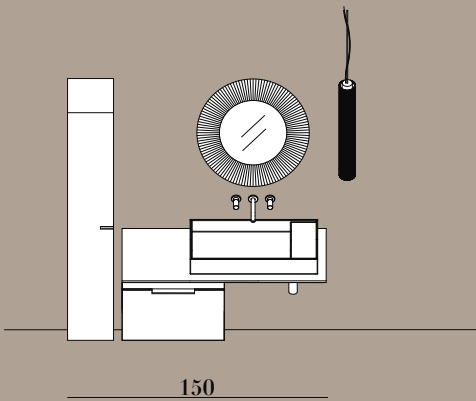
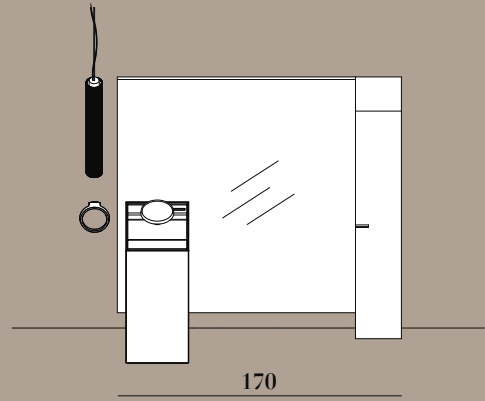
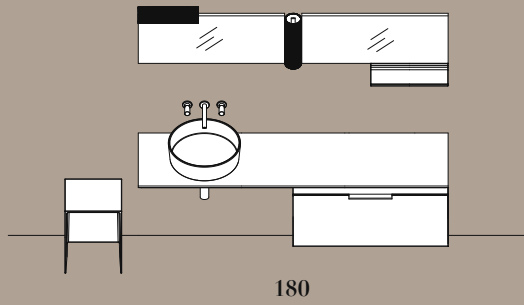
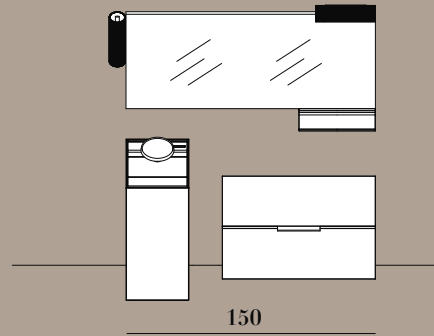
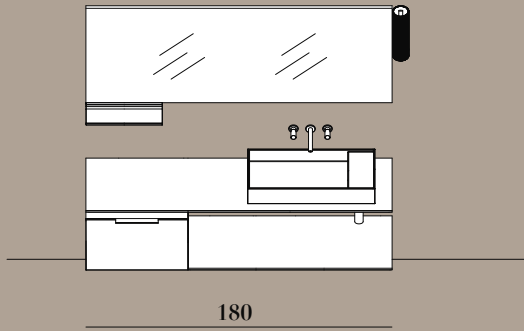
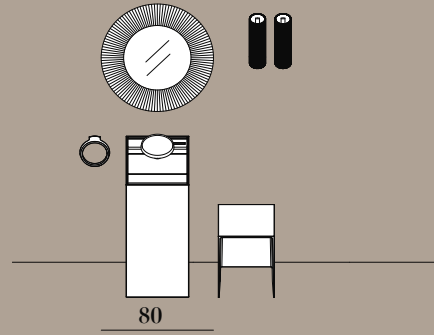
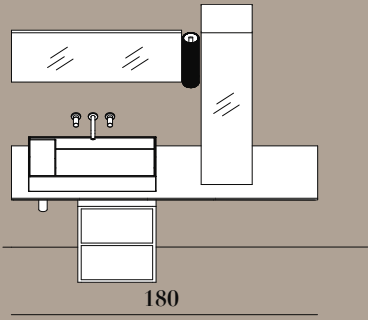

COMPLEMENTS

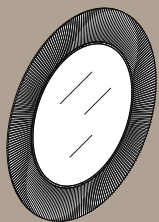

All saints_mirror

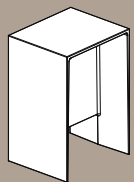

Max-Beam_stool

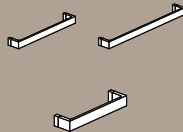

Rail_towel rail



Ring Ring_towel rail

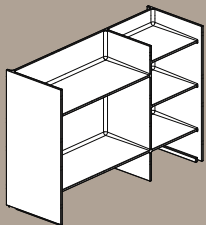

Sound-rack_rack

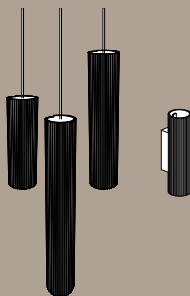

Rifly_lamp

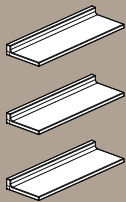

Shellfish_shelf

Kartell by **LAUFEN**

kartell.it / laufen.com

_CONCEPT, GRAPHICS & STYLING: PS+A / _PHOTOS: ADRIANO BRUSAFERRI