





Mallorca







Mallorca





Pieza Piece
40 x 60 cm.

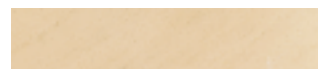

Rodapié Recto
Recto skirting
8 x 40 cm.

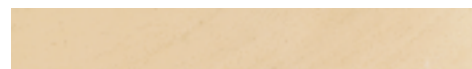

Rodapié Recto
Recto skirting
8 x 60 cm.



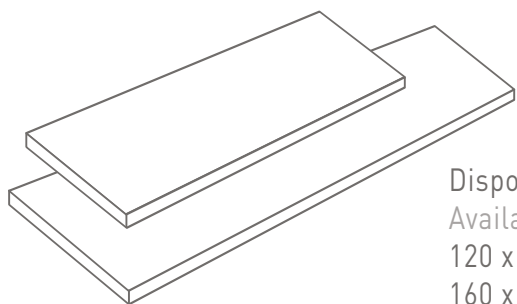

Disponible peldaño
Available stair tread
120 x 33 x 1,8 cm.
160 x 33 x 1,8 cm.

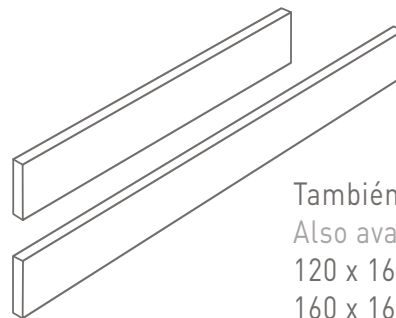

También disponible en tabicas
Also available in stair risers
120 x 16 cm.
160 x 16 cm.









FORMATO	PESO PIEZA	PZAS. CAJA	M ² . CAJA	PESO CAJA	Nº CAJAS PALET	PESO PALET
SIZE	PIECES WEIGHT	PIECES / BOX	SQM / BOX	WEIGHT BOX	BOXES / PALLET	WEIGHT PALLET
8 x 40	0,735 Kg.	21	8,400 ml/caja	15,600 Kg.	S.P./U.O.*	S.P./U.O.*
8 x 60	1,100 Kg.	12	7,200 ml/caja	13,400 Kg.	S.P./U.O.*	S.P./U.O.*
40 x 60	5,600 Kg.	5	1,200	28,200 Kg.	48	1400 kg.
120 x 16	4,800 Kg.	10	-----	48,200 Kg.	S.P./U.O.*	S.P./U.O.*
160 x 16	6,400 Kg.	10	-----	64,200 Kg.	S.P./U.O.*	S.P./U.O.*
120 x 33 x 1,8	16,000 Kg.	3	-----	48,200 Kg.	18	870 kg.
160 x 33 x 1,8	21,000 Kg.	3	-----	63,200 Kg.	18	1150 Kg.









*S.P. Según Pedido / U.O. Under Order



Características Técnicas / Technical Features

DESCRIPCIÓN ICONOGRÁFICA DE LAS CARACTERÍSTICAS TÉCNICAS DEL PRODUCTO / ICONOGRAPHIC DESCRIPTION OF THE PRODUCT'S TECHNICAL FEATURES

Revestimiento Coating		
Pavimento Floor tile		
Destonificado Colour Variety		
Alto tránsito Busy transit		
Absorción de agua Water absorption UNE-EN 10545-3		< 0,5
Coefficiente de dilatación térmica Lineal thermal expansion coefficient UNE-EN 10545-8		< 9x10 ⁶ /°C
Resistencia a las manchas Resistance to staining UNE-EN 10545-14		Resiste
Junta estéticamente recomendada Joint aestetically recommended		Junta 2 mm
Resistencia al deslizamiento pie calzado Sliding coefficient barefoot (DIN 51130)		Sin clasificación hasta R-11

Dureza mohs Surface scratch hardness (mohs scale) UNE-EN 67.101		6 - 8
Resistencia a la flexión Bending resistance UNE-EN 10545-4		35-55 N/mm ²
Grosor de pieza Thickness		10 mm.
Higiénico: resistente a productos de limpieza con químicos fuertes Hygienic: resistance to chemical etching UNE-EN 10545-13		Resiste
Resistencia a la abrasión superficial Surface abrasion resistance UNE-EN 10545-6		PEI 3-4
Resistencia al choque térmico Resistance against thermal shocks UNE-EN 10545-9		Resiste
Resistencia al hielo Frost resistance UNE-EN 10545-12		Resiste
Coefficiente deslizamiento pie descalzo Sliding coefficient naked foot (DIN 51097)		Sin clasificación hasta clase C
Resistencia al deslizamiento Sliding resistance UNE-ENV 12633		Clase 1-3



*Todos los modelos ARTTEK estan disponibles en:
CLASE 1: RECOMENDADO PARA INTERIORES.
CLASE 3: RECOMENDADO PARA EXTERIORES,
PISCINAS Y ZONAS HÚMEDAS.

*All the ARTTEK models are available in:
CLASS 1: RECOMMENDED FOR INTERIORS.
CLASS 3: RECOMMENDED FOR EXTERIORS,
SWIMMING POOLS AND WET AREAS.

