

LOOKBACK

METAL



* Lookback. Content of recycled material. Contenuto di materiale riciclato. Contenido de material reciclado.

FORMATS.FORMATI.FORMATOS

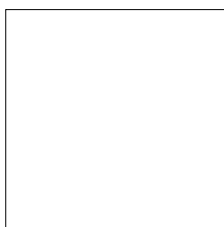

90X90
89,46x89,46 cm - 35.22"x35.22"



45X90
44,63x89,46 cm - 17.61"x35.22"

COLOURS COLORI COLORES



White



Black



Green

FINISHES FINITURI ACABADOS



Lappato

SPECIAL PIECES.PEZZI SPECIALI.PIEZAS ESPECIALES

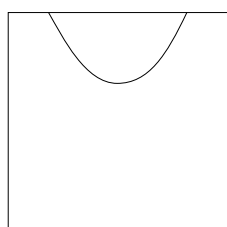

90X90 Bag
89,46x89,46 cm - 35.22"x35.22"

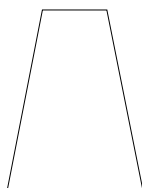

35X45 Trapeza
35x44,63 cm - 13.77"x17.61"

45X90 Bag
44,63x89,46 cm - 17.57"x35.22"

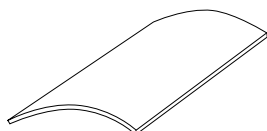

45X90 Vexa
44,63x89,46 cm - 17.61"x35.22"

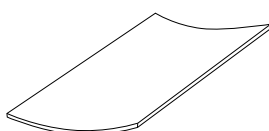

45X90 Cave
44,63x89,46 cm - 17.61"x35.22"



7,5X90 rodapié
7,3x89,46 cm - 2.87"x35.22"



7,5X45 rodapié
7,3x44,63 cm - 2.87"x17.61"

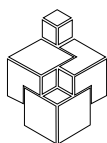

29X32 mosaico cube
28,50x31,50 cm - 11.22"x12.40"



30X30 mosaico 5x5
29,75x29,75 cm - 11.71"x11.71"

THICKNESS.SPESSORE.ESPESORES

≡ 0,74 cm / 0,29" approx.

BASE TILES.BASE.BASES

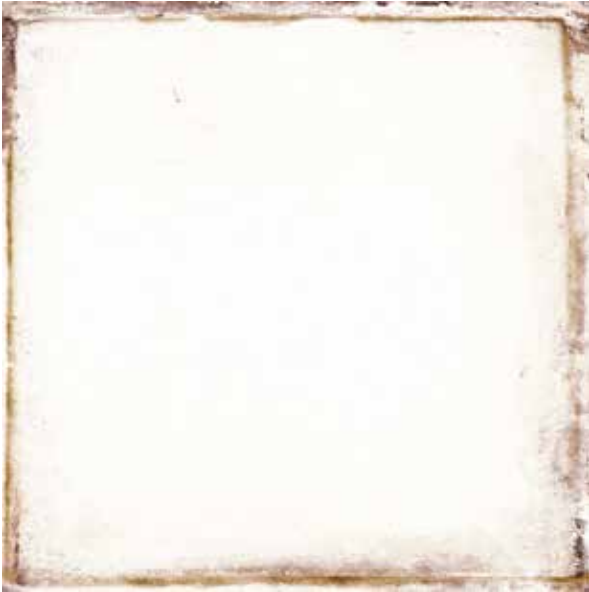

Lookback white lappato
89,46x89,46 cm - 35.22"x35.22"
G-6394



Lookback white lappato
44,63x89,46 cm - 17.57"x35.22"
G-6274

SPECIAL PIECES.PEZZI SPECIALI. PIEZAS ESPECIALES



Lookback white lappato trapeze
35x44,63 cm - 13.77"x17.57"
G-5211



Lookback white lappato rodapié 90
7,3x89,46 cm - 2.87"x35.22"
G-5125



Lookback white lappato rodapié 45
7,3x44,63 cm - 2.87"x23.45"
G-5085



Lookback mix lappato mosaico cube
35x44,63 cm - 13.77"x17.57"
G-5243

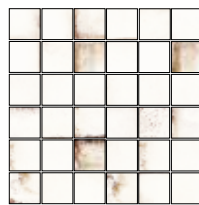

Lookback white lappato mosaico 5x5
29,75x29,75 cm - 11.71"x11.71"
G-6644

** For projects check technical information with our commercial network.
**Per i progetti ottenere informazioni tecniche attraverso la nostra rete commerciale.
** Para proyectos obtenga información técnica a través de nuestra red comercial.

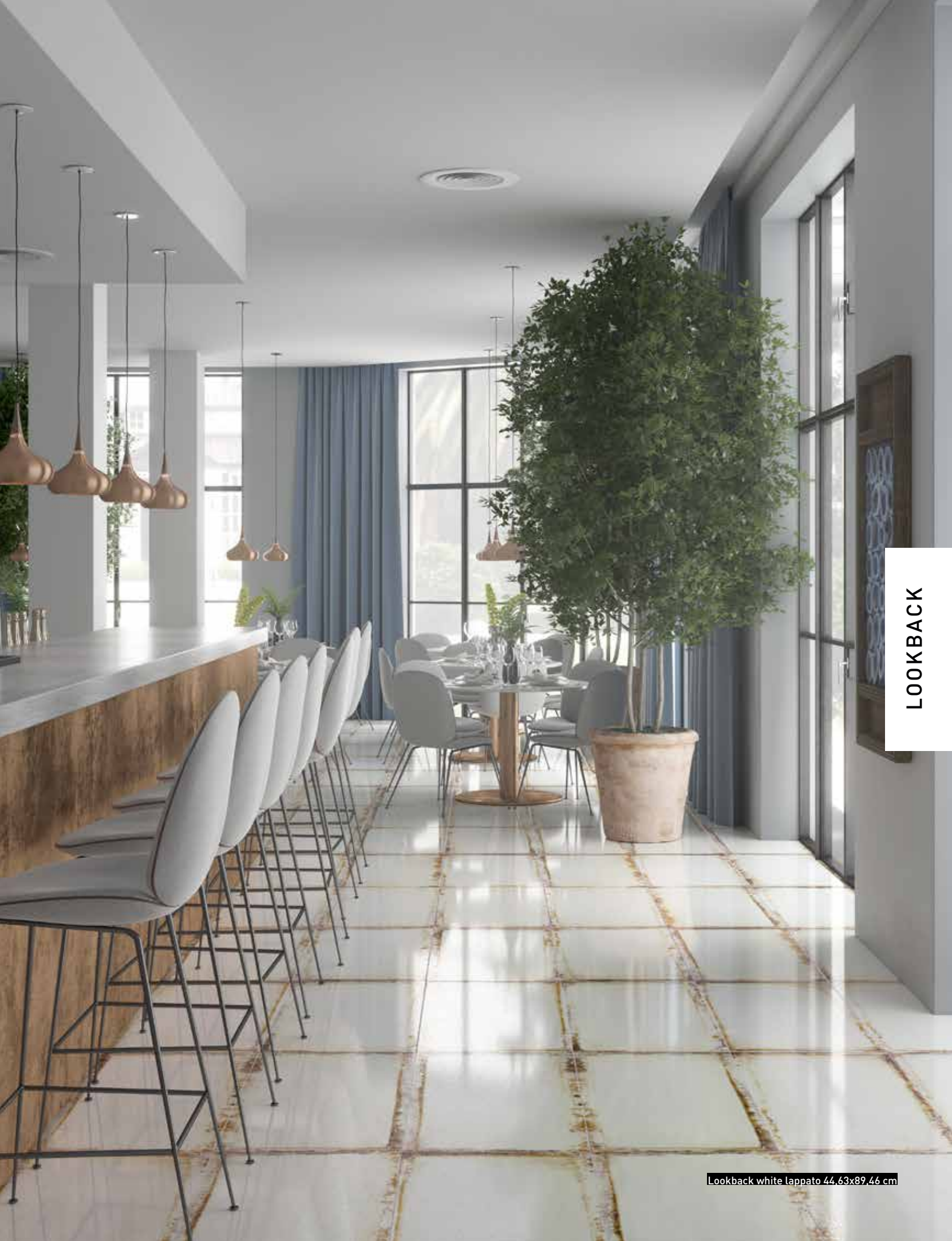

LOOKBACK

Lookback white lappato 44.63x89.46 cm

BASE TILES.BASE.BASES



Lookback green lappato
 89,46x89,46 cm - 35.22"x35.22"
G-6394



Lookback green lappato
 44,63x89,46 cm - 17.57"x35.22"
G-6274

SPECIAL PIECES.PEZZI SPECIALI. PIEZAS ESPECIALES



Lookback green lappato trapeze
 35x44,63 cm - 13.77"x17.57"
G-5211



Lookback green lappato rodapié 90
 7,3x89,46 cm - 2.87"x35.22"
G-5125



Lookback green lappato rodapié 45
 7,3x44,63 cm - 2.87"x23.45"
G-5085



Lookback mix lappato mosaico cube
 35x44,63 cm - 13.77"x17.57"
G-5243

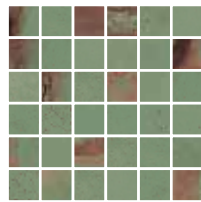

Lookback green lappato mosaico 5x5
 29,75x29,75 cm - 11.71"x11.71"
G-6644

**** For projects check technical information with our commercial network.**
 **Per i progetti ottenere informazioni tecniche attraverso la nostra rete commerciale.
 ** Para proyectos obtenga información técnica a través de nuestra red comercial.



LOOKBACK

Lookback green lappato 89,46x89,46 cm

LOOKBACK BLACK

lappato **CLASE 2** **R10**** **DCOF>0.42**
UNE - ENV 12633 DIN 51130 ANSI A 137.1 - 2012

BASE TILES.BASE.BASES



Lookback black lappato
 89,46x89,46 cm - 35.22"x35.22"
G-6394



Lookback black lappato
 44,63x89,46 cm - 17.57"x35.22"
G-6274

SPECIAL PIECES.PEZZI SPECIALI. PIEZAS ESPECIALES



Lookback black lappato trapeze
 35x44,63 cm - 13.77"x17.57"
G-5211



Lookback black lappato rodapié 90
 7,3x89,46 cm - 2.87"x35.22"
G-5125



Lookback black lappato rodapié 45
 7,3x44,63 cm - 2.87"x23.45"
G-5085



Lookback mix lappato mosaico cube
 35x44,63 cm - 13.77"x17.57"
G-5243

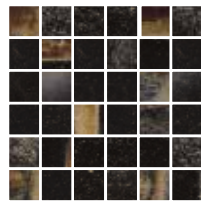

Lookback black lappato mosaico 5x5
 29,75x29,75 cm - 11.71"x11.71"
G-6644

**** For projects check technical information with our commercial network.**
****Per i progetti ottenere informazioni tecniche attraverso la nostra rete commerciale.**
**** Para proyectos obtenga información técnica a través de nuestra red comercial.**



LOOKBACK

Lookback black lappato 89,46x89,46 cm

LOOKBACK

3Dimensional

SPECIAL PIECES.
PEZZI SPECIALI. PIEZAS ESPECIALES

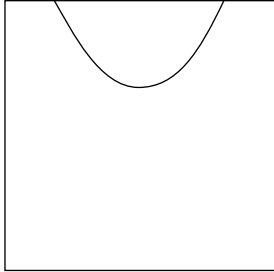

BAG*

89,55x89,55 cm / 44,63"x89,55"

- Lookback Bag 89,46x89,46 cm* **G-5795**
- Lookback Bag 44,63x89,46 cm* **G-5599**

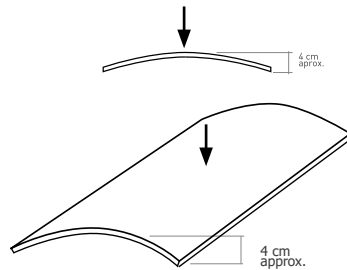
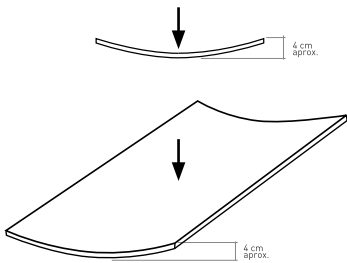

CAVE*

44,63x89,46 cm / 17,61"x35,22"

- Lookback Cave 44,63x89,46 cm* **G-5599**

VEXA*

44,63x89,46 cm / 17,61"x35,22"

- Lookback Vexa 89,46x89,46 cm* **G-5599**

STEPS.GRADINI.PELDAÑOS

		natural	
SIMPLE		peldaño simple-45 (45x90 cm)	5305
		peldaño simple-90 (90x90 cm)	5585
		peldaño simple áng. (45x90 cm)	5315
		peldaño simple áng. (90x90 cm)	5609
GRADONE		peldaño grad-45 (45x90 cm)	5603
		peldaño grad-90 (90x90 cm)	5779
		peldaño grad. áng. (45x90 cm)	5623
		peldaño grad. áng. (90x90 cm)	5829

This is a natural product made through a handmade process, therefore, its possible shade or size variations must be considered as typical features of the material and they will not be admitted in a claim.
Este es un producto natural fabricado artesanalmente, por lo que posibles variaciones de tono o dimensión deben considerarse propias del material y no será objeto de reclamación.

* Available in all colours from Lookback collection.
*Disponibile in todos los colores de la colección Lookback.

















LOOKBACK

Wall: Lookback black trapeze 35,44x44,63 cm
Floor: Garoe white natural 19,71x119,3 cm

TECHNICAL CHARACTERISTICS. CARATTERISTICHE TECNICHE. CARACTERÍSTICAS TÉCNICAS

MEASUREMENTS AND SURFACES APPEARANCE DIMENSIONI E ASPETTO SUPERFICIALE MEDIDAS Y ASPECTO SUPERFICIAL		STANDARD TEST METHOD METODO DELLA NORMA MÉTODO DE ENSAYO	STANDARD PRESCRIBED VALUES VALORE PRESCRITTO VALORES STANDARD NORMA	LOOKBACK collection *
	Length and width. Lunghezza e larghezza. Longitud y anchura. Länge und Breite	ISO 10545-2	± 0,6% max.	± 0,2%
	Orthogonality. Ortogonalità. Ortogonalidad. Rechtwinkligkeit	ISO 10545-2	± 0,5% max.	± 0,2%
	Straightness of sides. Rettilinearità dei lati. Rectitud de lados. Kantengeradigkeit	ISO 10545-2	± 0,5% max.	± 0,2%
	Surfaces flatness. Planarità. Planitud. Ebenflächigkeit	ISO 10545-2	± 0,5% max.	± 0,2%
PHYSICAL PROPERTIES PROPIETÀ FISICHE PROPIEDADES FÍSICA				
	Water absorption. Assorbimento d' acqua. Absorción de agua. Wasseraufnahme	ISO 10545-3	≤ 0,5%	< 0,1%
	Breaking strength, in N. Carico di rottura, en N. Carga de rotura, en N. Bruchlast, in N	ISO 10545-4	≥ 700 N	> 1400 N
	Modulus of rupture Resistenza alla flessione. Resistencia a la flexión. Biegefestigkeit	ISO 10545-4	≥ 35 N/mm ²	> 40 N/mm ²
	Resistance to thermal shock. Resistenza agli sbalzi termici. Resistencia al choque térmico. Temperaturwechselbeständigkeit	ISO 10545-9	No surface defects should be visible Non deve presentare difetti visibili No debe presentar defectos superficiales visibles	Resistant. Resistente. Resistente
	Frost resistance. Resistenza al gelo. Resistencia a la helada. Frostbeständigkeit	ISO 10545-12	No surface defects or cracks should be visible Non deve presentare difetti visibili No debe presentar defectos ni grietas superficiales visibles	Frost Resistant Antighiaccio Resistente a la Helada
	Coefficient of friction. Resistenza allo scivolamento. Coeficiente de fricción. Rutschfestigkeit	DIN 51130 UNE-ENV 12633 DCOF - ANSIA 137.1	-	R10 Clase 2 > 0.42
	Colour resistance to light. Resistenza dei colori alla luce. Resistencia del color a la luz. Lichtbeständigkeit der Farben	DIN 51094	There should be no colour variations Non deve presentare difetti visibili No debe presentar variaciones de color	No alterations in colour and shine Non presenta alterazioni di colori e lucentezza No presenta variaciones de color y brillo
CHEMICAL PROPERTIES PROPIETÀ CHIMICHE PROPIEDADES QUÍMICAS				
	Chemical resistance. Resistenza agli agenti chimici. Resistencia química. Chemikalienbeständigkeit	ISO 10545-13	Resistance to household cleaning products and swimmingpools salts. Resistencia a productos domésticos y sales para piscinas.	Min. UB
	Resistance to staining. Resistenza alle macchie. Resistencia a las manchas. Fleckenbeständigkeit	ISO 10545-14	Declared Value Valor Declarado	5

* The Land values are the average of different production consignments. For further detail information, please check with our commercial network.
Los valores declarados son el promedio obtenido a través de ensayos de diferentes producciones. Para la obtención de una información detallada consultar a la red comercial.
For projects check technical information with our commercial networks. / Para proyectos obtenga información técnica a través de nuestra red comercial.

** For projects check technical information with our commercial network.
** Per i progetti ottenere informazioni tecniche attraverso la nostra rete commerciale.
** Para proyectos obtenga información técnica a través de nuestra red comercial.



LOOKBACK

Wall: Lookback Green Lappato 89,46x89,46 cm
Lookback White Lappato 89,46x89,46 cm
Floor: Lookback Mix Lap. Mos. Cube 28,5x31,5 cm

RAMBLA

ENCAUSTIC

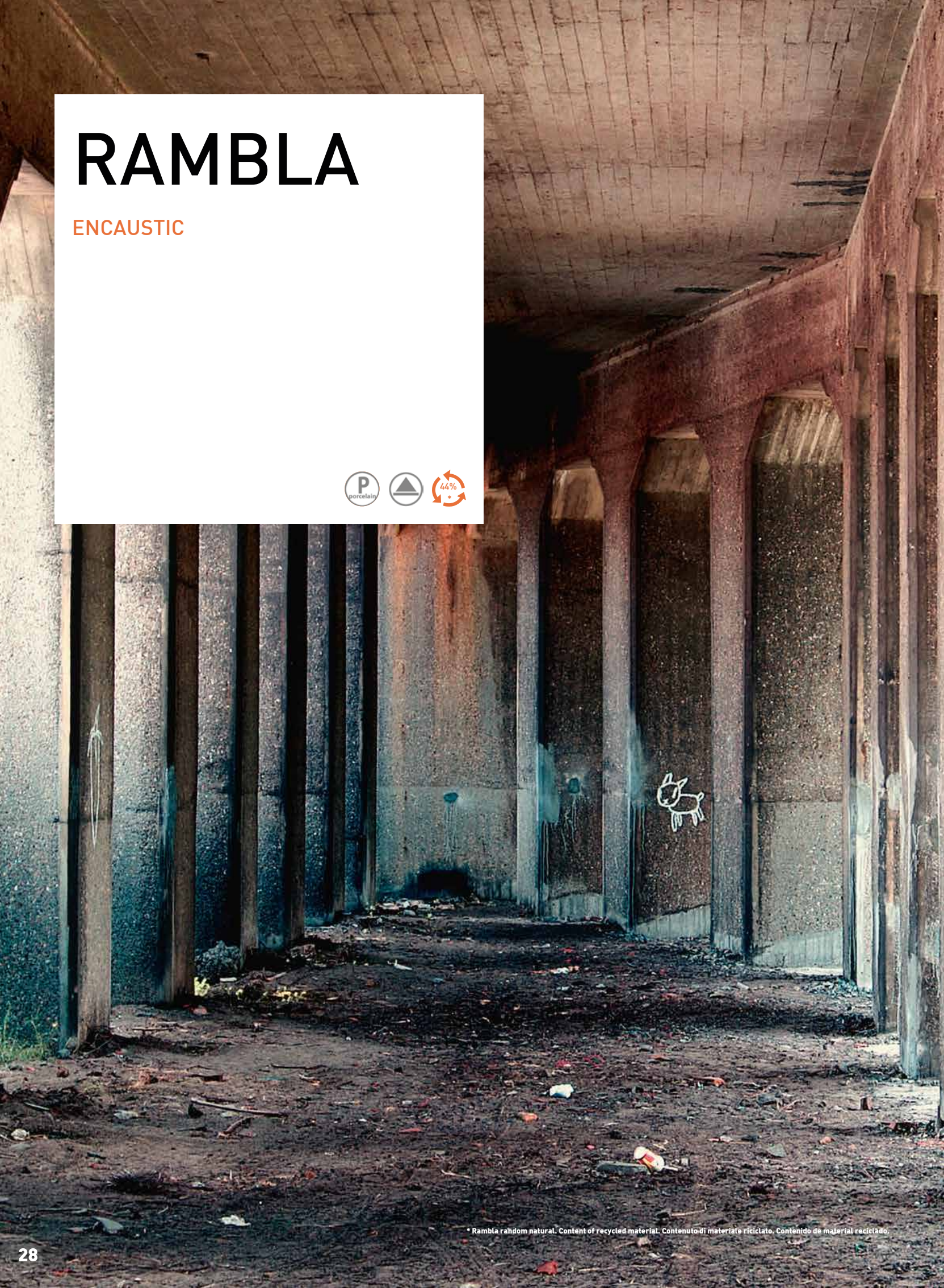

* Rambla random natural. Content of recycled material. Contenuto di materiale riciclato. Contenido de material reciclado.

FORMATS.FORMATI.FORMATOS

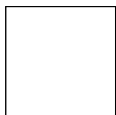

30X30
29,75x29,75 cm - 11.71"x11.71"

SPECIAL PIECES.PEZZI SPECIALI.PIEZAS ESPECIALES



30X30 mosaico 5x5
29,75x29,75 cm - 11.71"x11.71"



Rodapié 7,5x30
7,3x29,75 cm - 2.92"x11.71"

THICKNESS.SPESSORE.ESPESORES

 1 cm approx. / 0.39" approx.

COLOURS COLORI COLORES



Ivory



Abyss



Alchemy

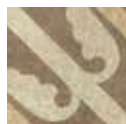

Clip



Random

FINISHES FINITURI ACABADOS



Natural

RAMBLA

RAMBLA WHITE

CLASE 2 R10** DCOF>0.42
UNE - ENV 12633 ANSI A 137.1 - 2012

BASE TILES.BASE.BASES



Rambla ivory natural
29,75x29,75 cm - 11.71"x11.71"
G-6286

SPECIAL PIECES.PEZZI SPECIALI. PIEZAS ESPECIALES



**Rambla ivory natural
mosaico 5x5**
29,75x29,75 cm - 11.71"x11.71"
G-6666



Rambla ivory natural rodapié
7,3x29,75 cm - 2.92"x11.71"
G-5065

RAMBLA ABYSS / ALCHEMY / CLIP

BASE TILES.BASE.BASES



Rambla abyss natural
29,75x29,75 cm - 11.71"x11.71"
G-6286



Rambla alchemy natural
29,75x29,75 cm - 11.71"x11.71"
G-6286



Rambla clip natural
29,75x29,75 cm - 11.71"x11.71"
G-6286

** For projects check technical information with our commercial network.
**Per i progetti ottenere informazioni tecniche attraverso la nostra rete commerciale.
** Para proyectos obtenga información técnica a través de nuestra red comercial.



RAMBLA

Rambla Abyss Natural 29.75x29.75 cm

RAMBLA RANDOM

CLASE 2 | R10** | DCOF>0.42
 UNE - ENV 12633 | DIN 51130 | ANSI A 137.1 - 2012

BASE TILES.BASE.BASES



Rambla ivory natural
 29,75x29,75 cm - 11.71"x11.71"
 G-6286

Rambla random natural *
 mosaico 5x5
 29,75x29,75 cm - 11.71"x11.71"
 G-6286

SPECIAL PIECES.PEZZI SPECIALI. PIEZAS ESPECIALES

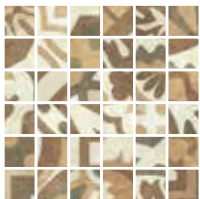

Rambla random natural
 mosaico 5x5
 29,75x29,75 cm - 11.71"x11.71"
 G-6666



Rambla ivory natural
 mosaico 5x5
 29,75x29,75 cm - 11.71"x11.71"
 G-6666



Rambla ivory natural rodapié
 7,3x29,75 cm - 2.92"x11.71"
 G-5065

*13 DIFFERENT ALEATORY PATTERNS.
 *13 DECORACIONES DIFERENTES ALEATORIAS

** For projects check technical information with our commercial network.
 **Per i progetti ottenere informazioni tecniche attraverso la nostra rete commerciale.
 ** Para proyectos obtenga información técnica a través de nuestra red comercial.



WHETHER
You Are
KIND
IT NOT ONLY CHANGES
IT CHANGES THE
World





Wherever
you go
NO MATTER
THE WEATHER
ALWAYS BRING
YOUR OWN
SUNSHINE









PINOT NOIR MERLOT CABERNET



RAMBLA

Rambla Random Natural 29.75x29.75 cm

TECHNICAL CHARACTERISTICS. CARATTERISTICHE TECNICHE. CARACTERÍSTICAS TÉCNICAS

MEASUREMENTS AND SURFACES APPEARANCE DIMENSIONI E ASPETTO SUPERFICIALE MEDIDAS Y ASPECTO SUPERFICIAL	STANDARD TEST METHOD METODO DELLA NORMA MÉTODO DE ENSAYO	STANDARD PRESCRIBED VALUES VALORE PRESCRITTO VALORES STANDARD NORMA	RAMBLA collection*
 Length and width. <i>Lunghezza e larghezza.</i> Longitud y anchura. Länge und Breite	ISO 10545-2	± 0,6% max.	± 0,2%
 Orthogonality. <i>Ortogonalità.</i> Ortogonalidad. Rechtwinkligkeit	ISO 10545-2	± 0,5% max.	± 0,2%
 Straightness of sides. <i>Rettilineità dei lati.</i> Rectitud de lados. Kantengeradigkeit	ISO 10545-2	± 0,5% max.	± 0,2%
 Surfaces flatness. <i>Planarità.</i> Planitud. Ebenflächigkeit	ISO 10545-2	± 0,5% max.	± 0,2%

PHYSICAL PROPERTIES PROPIETÀ FISICHE PROPIEDADES FÍSICA			
 Water absorption. <i>Assorbimento d'acqua.</i> Absorción de agua. Wasseraufnahme	ISO 10545-3	≤ 0,5%	≤ 0,1%
 Breaking strength, in N. <i>Carico di rottura, en N.</i> Carga de rotura, en N. Bruchlast, in N	ISO 10545-4	1300 N	≥ 2400 N
 Modulus of rupture. <i>Resistenza alla flessione.</i> Resistencia a la flexión. Biegefestigkeit	ISO 10545-4	≥ 35 N/mm ²	56 N/mm ²
 Resistance to deep abrasion. <i>Resistenza all'abrasione profonda.</i> Resistencia a la abrasión profunda. Tiefverschleissbeständigkeit	ISO 10545-6	≤ 175 mm ³	115 mm ³
 Resistance to thermal shock. <i>Resistenza agli sbalzi termici.</i> Resistencia al choque térmico. Temperaturwechselbeständigkeit	ISO 10545-9	No surface defects should be visible Non deve presentare difetti visibili No debe presentar defectos superficiales visibles	Resistant. Resistente. Resistente
 Frost resistance. <i>Resistenza al gelo.</i> Resistencia a la helada. Frostbeständigkeit	ISO 10545-12	No surface defects or cracks should be visible Non deve presentare difetti visibili No debe presentar defectos ni grietas superficiales visibles	Frost Resistance Antighiaccio Resistente a la Helada
 Coefficient of friction. <i>Resistenza allo scivolamento.</i> Coeficiente de fricción. Rutschfestigkeit	DIN 51130 UNE-ENV 12633 DCOF - ANSIA 137.1	-	R10** Clase 2 *** >0.42
 Colour resistance to light. <i>Resistenza dei colori alla luce.</i> Resistencia del color a la luz. Lichtbeständigkeit der Farben	DIN 51094	There should be no colour variations Non deve presentare difetti visibili No debe presentar variaciones de color	No alterations in colour and shine Non presenta alterazioni di colori e lucentezza No presenta variaciones de color y brillo

CHEMICAL PROPERTIES PROPIETÀ CHIMICHE PROPIEDADES QUÍMICAS			
 Chemical resistance. <i>Resistenza agli agenti chimici.</i> Resistencia química. Chemikalienbeständigkeit	ISO 10545-13	Resistance to household cleaning products and swimming-pools salts. Resistencia a productos de limpieza y sales para piscinas	Min. UB
 Resistance to staining. <i>Resistenza alle macchie.</i> Resistencia a las manchas. Fleckenbeständigkeit	ISO 10545-14	Declared Value Valor Declarado	5

* **Natural finish.** The *Land values* are the average of different production consignments. For further detail information, please check with our commercial network. /
I valori dichiarati sono ottenuti da una media di prove effettuate su diverse produzioni. Per avere informazioni dettagliate consultare la rete commerciale /
Los valores declarados son el promedio obtenido a través de ensayos de diferentes producciones. Para la obtención de una información detallada consultar a la red comercial.

** **Tested in Natural finish.** For projects check technical information with our commercial networks. /
Per progetti ottenere informazioni tecniche attraverso la nostra rete commerciale. / Para proyectos obtenga información técnica a través de nuestra red comercial.

*** **Tested in Natural finish.** (It depends on the consignment) Test realized in internal laboratory. / Prova effettuata in laboratorio interno. / Ensayo realizado en laboratorio interno.

**** **Dry Test,** according to document DA DB-SUA/3 (Código Técnico de la Edificación) M° de Fomento.
Ensayo realizado, según documento DA DB-SUA/3 (Código Técnico de la edificación) M° de Fomento



RAMBLA

Rambla Alchemy natural 29.75x29.75 cm

NOUVEAU

ENCAUSTIC



FORMATS.FORMATI.FORMATOS



30X30
29,75x29,75 cm - 11.71"x11.71"

SPECIAL PIECES.PEZZI SPECIALI.PIEZAS ESPECIALES



30X30 mosaico 5x5
29,75x29,75 cm - 11.71"x11.71"



Rodapié 7,5x30
7,3x29,75 cm - 2.92"x11.71"

THICKNESS.SPESSORE.ESPESORES

\pm 1 cm approx. / 0.39" approx.

COLOURS COLORI COLORES

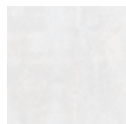

Ivory



Light



Dark



Random



Inox

FINISHES FINITURI ACABADOS



Natural



Lappato

NOUVEAU

NOUVEAU WHITE

natural

CLASE 1
UNE - ENV 12633

R9**
DIN 51130

DCOF>0.42
ANSI A 137.1 - 2012

BASE TILES.BASE.BASES



Nouveau ivory natural
29,75x29,75 cm - 11.71"x11.71"
G-6286

SPECIAL PIECES.PEZZI SPECIALI. PIEZAS ESPECIALES



**Rambla ivory natural
mosaico 5x5**
29,75x29,75 cm - 11.71"x11.71"
G-6666

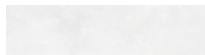

Rambla ivory natural rodapié
7,3x29,75 cm - 2.92"x11.71"
G-5065

NOUVEAU DARK GREY / LIGHT GREY

BASE TILES.BASE.BASES



Nouveau dark grey natural
29,75x29,75 cm - 11.71"x11.71"
G-6286



Nouveau light grey natural
29,75x29,75 cm - 11.71"x11.71"
G-6286

** For projects check technical information with our commercial network.
**Per i progetti ottenere informazioni tecniche attraverso la nostra rete commerciale.
** Para proyectos obtenga información técnica a través de nuestra red comercial.



NOUVEAU

Nouveau ivory natural - light grey natural 29.75x29.75 cm

NOUVEAU RANDOM GREY

natural

CLASE 1
UNE - ENV 12633

R9**
DIN 51130

DCOF>0.42
ANSI A 137.1 - 2012

BASE TILES.BASE.BASES



Nouveau random grey natural*
29,75x29,75 cm - 11.71"x11.71"
G-6286

SPECIAL PIECES.PEZZI SPECIALI. PIEZAS ESPECIALES



Nouveau random grey natural
mosaico 5x5
29,75x29,75 cm - 11.71"x11.71"
G-6666

*30 DIFFERENT ALEATORY PATTERNS.
*30 DECORACIONES DIFERENTES ALEATORIAS

** For projects check technical information with our commercial network.
**Per i progetti ottenere informazioni tecniche attraverso la nostra rete commerciale.
** Para proyectos obtenga información técnica a través de nuestra red comercial.



NOUVEAU

Nouveau random grey natural 29,75x29,75 cm

NOUVEAU RANDOM INOX

natural

CLASE 1
UNE - ENV 12633

R9**
DIN 51130

DCOF>0.42
ANSI A 137.1 - 2012

BASE TILES.BASE.BASES

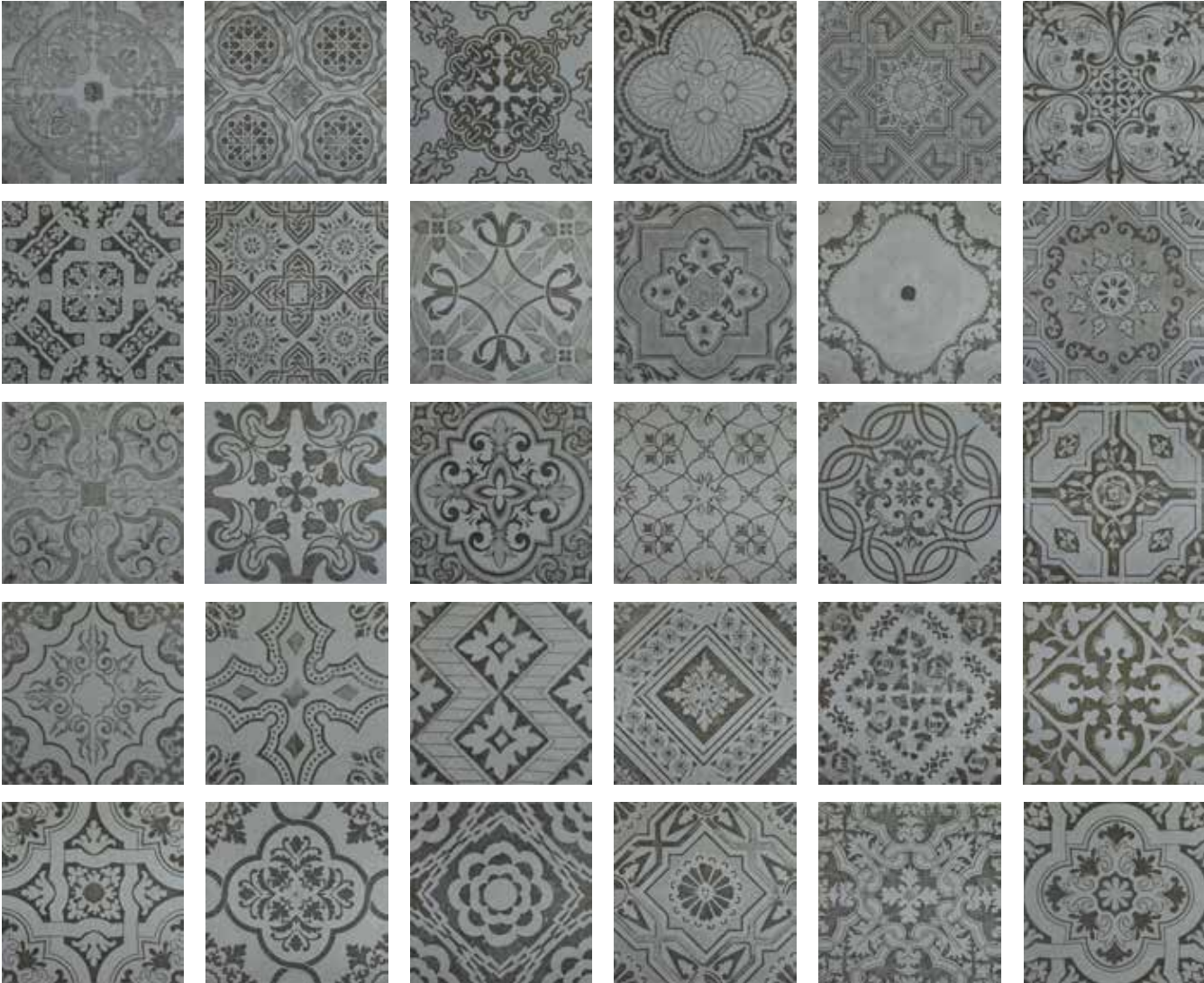

Nouveau random inox lappato*
29,75x29,75 cm - 11.71"x11.71"
G-6372

*30 DIFFERENT ALEATORY PATTERNS.
*30 DECORACIONES DIFERENTES ALEATORIAS





** For projects check technical information with our commercial network.
**Per i progetti ottenere informazioni tecniche attraverso la nostra rete commerciale.
** Para proyectos obtenga información técnica a través de nuestra red comercial.













NOUVEAU

Nouveau random inox lappato 29,75x29,75 cm

TECHNICAL CHARACTERISTICS. CARATTERISTICHE TECNICHE. CARACTERÍSTICAS TÉCNICAS

MEASUREMENTS AND SURFACES APPEARANCE DIMENSIONI E ASPETTO SUPERFICIALE MEDIDAS Y ASPECTO SUPERFICIAL	STANDARD TEST METHOD METODO DELLA NORMA MÉTODO DE ENSAYO	STANDARD PRESCRIBED VALUES VALORE PRESCRITTO VALORES STANDARD NORMA	NOUVEAU collection*
 Length and width. <i>Lunghezza e larghezza.</i> Longitud y anchura. Länge und Breite	ISO 10545-2	± 0,6% max.	± 0,2%
 90° Orthogonality. <i>Ortogonalità.</i> Ortogonalidad. Rechtwinkligkeit	ISO 10545-2	± 0,5% max.	± 0,2%
 Straightness of sides. <i>Rettilineità dei lati.</i> Rectitud de lados. Kantengeradigkeit	ISO 10545-2	± 0,5% max.	± 0,2%
 Surfaces flatness. <i>Planarità.</i> Planitud. Ebenfächigkeit	ISO 10545-2	± 0,5% max.	± 0,2%

PHYSICAL PROPERTIES PROPIETÀ FISICHE PROPIEDADES FÍSICA			
 Water absorption. <i>Assorbimento d'acqua.</i> Absorción de agua. Wasseraufnahme	ISO 10545-3	≤ 0,5%	≤ 0,1%
 Breaking strength, in N. <i>Carico di rottura, en N.</i> Carga de rotura, en N. Bruchlast, in N	ISO 10545-4	1300 N	≥ 2400 N
 Modulus of rupture. <i>Resistenza alla flessione.</i> Resistencia a la flexión. Biegefestigkeit	ISO 10545-4	≥ 35 N/mm ²	56 N/mm ²
 Resistance to deep abrasion. <i>Resistenza all'abrasione profonda.</i> Resistencia a la abrasión profunda. Tiefverschleissbeständigkeit	ISO 10545-6	≤ 175 mm ³	115 mm ³
 Resistance to thermal shock. <i>Resistenza agli sbalzi termici.</i> Resistencia al choque térmico. Temperaturwechselbeständigkeit	ISO 10545-9	No surface defects should be visible Non deve presentare difetti visibili No debe presentar defectos superficiales visibles	Resistant. <i>Resistente. Resistente</i>
 Frost resistance. <i>Resistenza al gelo.</i> Resistencia a la helada. Frostbeständigkeit	ISO 10545-12	No surface defects or cracks should be visible Non deve presentare difetti visibili No debe presentar defectos ni grietas superficiales visibles	Frost Resistance <i>Antighiaccio</i> Resistente a la Helada
 Coefficient of friction. <i>Resistenza allo scivolamento.</i> Coeficiente de fricción. Rutschfestigkeit	DIN 51130 UNE-ENV 12633 DCOF - ANSI A 137.1	-	R9** Clase I *** >0.42
 Colour resistance to light. <i>Resistenza dei colori alla luce.</i> Resistencia del color a la luz. Lichtbeständigkeit der Farben	DIN 51094	There should be no colour variations Non deve presentare difetti visibili No debe presentar variaciones de color	No alterations in colour and shine Non presenta alterazioni di colori e lucentezza No presenta variaciones de color y brillo

CHEMICAL PROPERTIES PROPIETÀ CHIMICHE PROPIEDADES QUÍMICAS			
 Chemical resistance. <i>Resistenza agli agenti chimici.</i> Resistencia química. Chemikalienbeständigkeit	ISO 10545-13	Resistance to household cleaning products and swimmingpools salts. Resistencia a productos domésticos y sales para piscinas	Min. UB
 Resistance to staining. <i>Resistenza alle macchie.</i> Resistencia a las manchas. Fleckenbeständigkeit	ISO 10545-14	Declared Value Valor Declarado	5

* Natural finish. The Land values are the average of different production consignments. For further detail information, please check with our commercial network. /
I valori dichiarati sono ottenuti da una media di prove effettuate su diverse produzioni. Per avere informazioni dettagliate consultare la rete commerciale /
Los valores declarados son el promedio obtenido a través de ensayos de diferentes producciones. Para la obtención de una información detallada consultar a la red comercial.

** Tested in Natural finish. For projects check technical information with our commercial networks. /
Per progetti ottenere informazioni tecniche attraverso la nostra rete commerciale. / Para proyectos obtener información técnica a través de nuestra red comercial.

*** Clase I - Tested in Natural finish. (It depends on the consignment) Test realized in internal laboratory. / Prova effettuata in laboratorio interno. / Ensayo realizado en laboratorio interno.

**** Dry Test, according to document DA DB-SUA/3 (Código Técnico de la Edificación) M° de Fomento. Test done in Nouveau Random Grey 30x30 on October 2014.
Ensayo realizado, según documento DA DB-SUA/3 (Código Técnico de la Edificación) M° de Fomento, sobre el producto Nouveau Random Grey 30x30 a fecha octubre 2014



NOUVEAU

Nouveau dark grey 29,75x29,75 cm - Legno ice 14,74x89,46 cm

MIDLAND

CONCRETE



FORMATS.FORMATI.FORMATOS



60X120
59,55x119,3 cm - 23.45"x46.97"



60X60
59,55x59,55 cm - 23.45"x23.45"



30X60
29,75x59,55 cm - 11.71"x23.45"

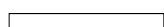

7,5X60
7,3x59,55 cm - 2.87"x23.45"

COLOURS COLORI COLORES

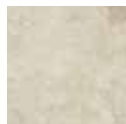

Ivory



Grey



Vison

SPECIAL PIECES.PEZZI SPECIALI.PIEZAS ESPECIALES

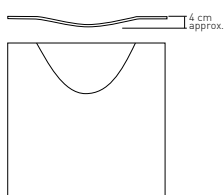

60X120 Bag*
59,55x119,30 cm - 23.45"x46.96"
60X60 Bag*
59,55x59,55 cm - 23.45"x23.45"
30X60 Bag*
29,75x59,55 cm - 11.71"x23.45"

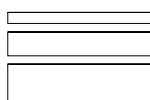

15X60 - 10x60 - 5x60
multiformat natural*
14,75x59,55 cm - 5.87"x23.45"
9,72x59,55 cm - 3.83"x23.45"
4,84x59,55 cm - 1.90"x23.45"



7,5X60
7,3x59,55 cm - 2.87"x23.45"



30X30 mosaico 5x5
29,75x29,55 cm - 11.71"x11.71"



30X30 mosaico 5x5 Multex
29,75x29,55 cm - 11.71"x11.71"



30X30 mosaico 3D
28,5x28,5 cm - 11.22"x11.22"

FINISHES FINITURI ACABADOS



Natural



Corrugato

THICKNESS.SPESSORE.ESPESORES

± 0,74 cm / 0.29" approx.

BASE TILES.BASE.BASES



Midland ivory natural
119,30x59,55 cm - 46.96"x23.45"
G-6372



Midland ivory natural
59,55x59,55 cm - 23.45"x23.45"
G-6224



Midland ivory natural
29,75x59,55 cm - 11.71"x23.45"
G-6194

SPECIAL PIECES.PEZZI SPECIALI. PIEZAS ESPECIALES



Midland ivory natural multiformato
4,84x59,55 cm - 1.90"x23.45"
9,72x59,55 cm - 3.82"x23.45"
14,75x59,55 cm - 5.80"x23.45"
G-6346



Midland ivory corrugato
29,75x59,55 cm - 11.71"x23.45"
G-6234



Midland ivory natural lista 60
7,3x59,55 cm - 2.87"x23.45"
G-5087



Midland ivory rodapié-60
7,3x59,55 cm - 2.87"x23.45"
G-5091

** For projects check technical information with our commercial network.
**Per i progetti ottenere informazioni tecniche attraverso la nostra rete commerciale.
** Para proyectos obtenga información técnica a través de nuestra red comercial.



MIDLAND

Midland ivory natural 59.55x119.30 cm

BASE TILES.BASE.BASES



Midland grey natural
119,30x59,55 cm - 46.96"x23.45"
G-6372



Midland grey natural
59,55x59,55 cm - 23.45"x23.45"
G-6224



Midland grey natural
29,75x59,55 cm - 11.71"x23.45"
G-6194

SPECIAL PIECES.PEZZI SPECIALI. PIEZAS ESPECIALES



Midland grey natural multiformato
4,84x59,55 cm - 1.90"x23.45"
9,72x59,55 cm - 3.82"x23.45"
14,75x59,55 cm - 5.80"x23.45"
G-6346



Midland grey corrugato
29,75x59,55 cm - 11.71"x23.45"
G-6234



Midland grey natural lista 60
7,3x59,55 cm - 2.87"x23.45"
G-5087

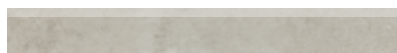

Midland grey rodapié-60
7,3x59,55 cm - 2.87"x23.45"
G-5091

** For projects check technical information with our commercial network.
** Per i progetti ottenere informazioni tecniche attraverso la nostra rete commerciale.
** Para proyectos obtenga información técnica a través de nuestra red comercial.

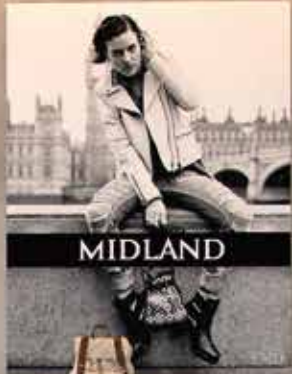
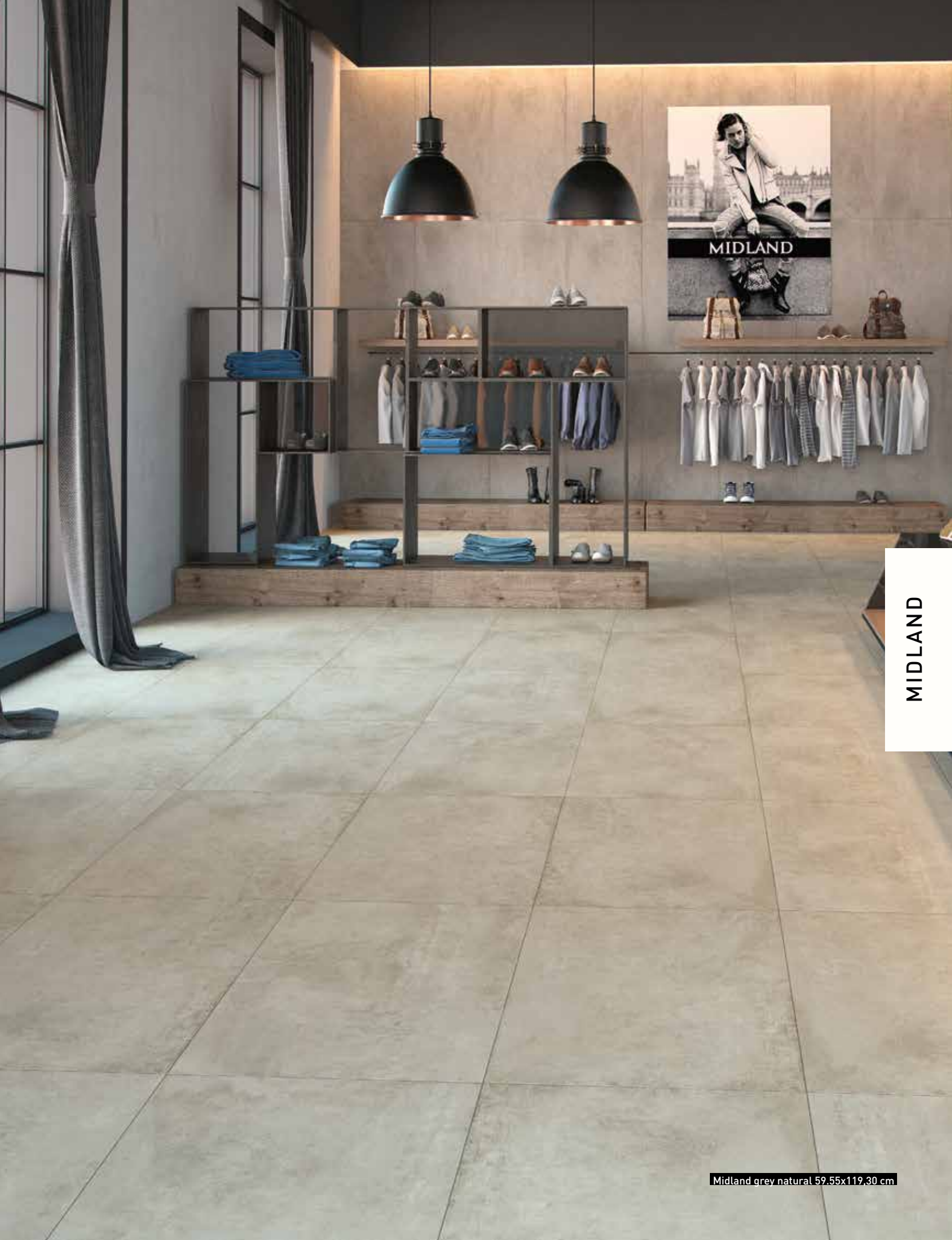

MIDLAND

Midland grey natural 59,55x119,30 cm

BASE TILES.BASE.BASES



Midland vison natural
119,30x59,55 cm - 46.96"x23.45"
G-6372



Midland vison natural
59,55x59,55 cm - 23.45"x23.45"
G-6224



Midland vison natural
29,75x59,55 cm - 11.71"x23.45"
G-6194

SPECIAL PIECES.PEZZI SPECIALI. PIEZAS ESPECIALES



Midland vison natural multiformato
4,84x59,55 cm - 1.90"x23.45"
9,72x59,55 cm - 3.82"x23.45"
14,75x59,55 cm - 5.80"x23.45"
G-6346



Midland vison corrugato
29,75x59,55 cm - 11.71"x23.45"
G-6234



Midland vison natural lista 60
7,3x59,55 cm - 2.87"x23.45"
G-5087



Midland vison rodapié-60
7,3x59,55 cm - 2.87"x23.45"
G-5091

** For projects check technical information with our commercial network.
**Per i progetti ottenere informazioni tecniche attraverso la nostra rete commerciale.
** Para proyectos obtenga información técnica a través de nuestra red comercial.



MIDLAND

Midland vison natural 59,55x59,55 cm

MIDLAND

corrugato

CLASE 3
UNE - ENV 12633

R11
DIN 51130

DCOF>0.42
ANSI A 137.1 - 2012

natural

CLASE 1
UNE - ENV 12633

R9**
DIN 51130

DCOF>0.42
ANSI A 137.1 - 2012

SPECIAL PIECES. PEZZI SPECIALI. PIEZAS ESPECIALES



Midland ivory mosaico 3D*
28,5x28,5 cm - 11.22"x11.22"
G-5187



Midland ivory-gold mos. 3D*
28,5x28,5 cm - 11.22"x11.22"
G-5211



Midland ivory-silver mos. 3D*
28,5x28,5 cm - 11.22"x11.22"
G-5211

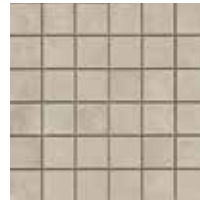

Midland ivory mosaico 5x5
29,75x29,75 cm - 11.71"x11.71"
G-6644



Midland ivory mos. multitec 5x5
29,75x29,75 cm - 11.71"x11.71"
G-6666



Midland grey mosaico 3D*
28,5x28,5 cm - 11.22"x11.22"
G-5187



Midland grey-gold mos 3D*
28,5x28,5 cm - 11.22"x11.22"
G-5211



Midland grey-silver mos 3D*
28,5x28,5 cm - 11.22"x11.22"
G-5211



Midland grey mosaico 5x5
29,75x29,75 cm - 11.71"x11.71"
G-6644



Midland grey mos. multitec 5x5
29,75x29,75 cm - 11.71"x11.71"
G-6666



Midland vison mosaico 3D*
28,5x28,5 cm - 11.22"x11.22"
G-5187



Midland vison-gold mos 3D*
28,5x28,5 cm - 11.22"x11.22"
G-5211



Midland vison-silver mos 3D*
28,5x28,5 cm - 11.22"x11.22"
G-5211



Midland vison mosaico 5x5
29,75x29,75 cm - 11.71"x11.71"
G-6644



Midland vison mos. multitec 5x5
29,75x29,75 cm - 11.71"x11.71"
G-6666

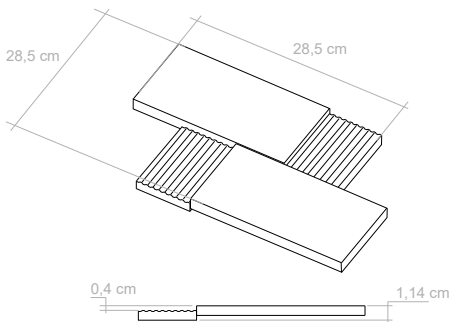

Physical Vapor Deposition (PVD)

Pvd is a field in the application of nanotechnology. The process consists of depositing layers of atoms, inside a vacuum chamber, to a solid surface. The layering is produced by the condensation of a vaporized metal (such as gold, titanium, platinum etc.) over the selected surface. Advantages: High resistance to abrasion and scratches; much higher than metals applied by firing. As a general rule, any non-aggressive, pH neutral product have to be used. Do not mix pieces from different lots. El PVD es uno de los campos de aplicación de la nanotecnología. El proceso consiste en depositar capas de átomos, en una cámara de alto vacío, sobre una superficie sólida. El recubrimiento se produce por la condensación de un metal vaporizado, oro, titanio, platino, ect, sobre el material a recubrir. Ventajas: Mayor resistencia al rayado y a la abrasión que los metales aplicados por cocción. Para la limpieza de estos materiales deben utilizarse productos no agresivos con pH neutro. No mezclar piezas de diferentes lotes.

* Midland mosaico 3D contains approximately 12'3 pieces/m²

* Midland mosaico 3D contiene aproximadamente 12,3 piezas/m²

* Midland mosaico 3D contiene aproximadamente 12,3 piezas/m²



Midland gold corrugato lappato
29,75x59,55 cm - 11.71"x23.45"
G-5401



Midland silver corrugato lappato
29,75x59,55 cm - 11.71"x23.45"
G-5401



Midland copper corrugato lappato
29,75x59,55 cm - 11.71"x23.45"
G-5431

** For projects check technical information with our commercial network.

**Per i progetti ottenere informazioni tecniche attraverso la nostra rete commerciale.

** Para proyectos obtenga información técnica a través de nuestra red comercial.

STEPS.GRADINI.PELDAÑOS

SIMPLE 

		natural
peldaño simple-120	(60x120 cm)	5519
peldaño simple	(60x60 cm)	5281
peldaño simple-60	(30x60 cm)	5171
peldaño simple-60 Corrugato	(30x60 cm)	5171
peldaño Ang	(60x60 cm)	5299
peldaño Ang	(30x60 cm)	5187
peldaño Ang Corrugato	(30x60 cm)	5187

GRADONE 

		natural
peldaño Gradone.-120	(60x120 cm)	5795
peldaño Gradone	(60x60 cm)	5559
peldaño Gradone-60	(30x60 cm)	5559
peldaño Grad.-60 Corrugato	(30x60 cm)	5559
peldaño Grad.Ang	(60x120 cm)	5815
peldaño Grad.Ang	(60x60 cm)	5609
peldaño Grad.Ang	(30x60 cm)	5609
peldaño Grad.Ang Corrug.	(30x60 cm)	5609



MIDLAND

Midland ivory natural 59,55x119,30 cm - Midland ivory mosaico 3D 28,5x28,5 cm