

TABELLA PREZZI FINITURE pag. 526

INFO TECNICHE pag. 526

INDICE / INDEX pag. 528

LAVABO pag. 531

BIDET pag. 531

DOCCIA INCASSO pag. 532

DEVIATORI INCASSO pag. 533

DOCCIA ESTERNO pag. 534

DOCCIA ESTERNO
THERMOSTATICO pag. 535

VASCA pag. 535

BAGNO COMPLEMENTI pag. 536



PREZZO FINITURE

Calcola il prezzo di listino (IVA esclusa) delle finiture diverse dal cromato, consultando la seguente tabella.

Moltiplicare il **PREZZO LISTINO** per il **COEFFICIENTE MOLTIPLICATORE** della finitura scelta, arrotondando per difetto il prezzo ottenuto (eliminare i centesimi).

ESEMPIO per ordinare art. 1505 in finitura dorato: codice **04-1505**

PRICE FINISHES

Include the list price (excluding VAT) of different finishes from chrome, consulting the following table. **Multiply the PRICE LIST MULTIPLIER COEFFICIENT** of the chosen finish, **reducing the price obtained by deleting the centesim.**

EXAMPLE to order art. 1505 gold finish: code **04-1505**

COMPOSIZIONE CODICE PER ORDINARE ARTICOLO IN FINITURA



CODICE FINITURA
FINISH CODE

CODICE ARTICOLO
ITEM NUMBER

FINITURE DI SERIE / STANDARD FINISHES

CODICE CODE	DESCRIZIONE FINITURA FINISH DESCRIPTION	MOLTIPLICATORE MULTIPLIER
01-	cromato / chrome	PREZZO LISTINO*
02-	cromo/oro / chrome/gold	x
04-	dorato / gold	x
05-	bronzo satinato / satin bronze	x
06-	rame vecchio / old copper	x
07-	vecchio argento / old silver	x
12-	ottone lucido / polished brass	x

FINITURE A RICHIESTA / ON REQUEST FINISHES

CODICE CODE	DESCRIZIONE FINITURA FINISH DESCRIPTION	MOLTIPLICATORE MULTIPLIER
33-	cromo satinato / satin chrome	x
34-	cromo spazzolato / brushing chrome	x
35-	nickel spazzolato / brushing nickel	x
56-	avorio / ivory	x
57-	azzurro / light blue	x
58-	verdino / light green	x
59-	marrone / brown	x
60-	arancio / orange	x
61-	rosso / red	x
66-	bianco opaco / mat white	x
67-	nero opaco / mat black	x
68-	rame opaco / mat copper	x
69-	argento opaco / mat silver	x
71-	oro opaco / mat gold	x
72-	bronzo opaco / mat bronze	x
75-	dorato spazzolato / brushing gold	x
87-	oro rosa / pink gold	x
88-	ottone sisal / sisal brass	x

FINITURE A RICHIESTA / ON REQUEST FINISHES

CODICE CODE	DESCRIZIONE FINITURA FINISH DESCRIPTION	MOLTIPLICATORE MULTIPLIER
03-	oro/argento / gold/silver	x
08-	canna di fucile / gun barrel	x
10-	verderame / verdigris	x
11-	nero antracite / anthracite black	x
13-	ottone naturale / natural brass	x
14-	nero / black	x
19-	bianco / white	x
28-	nickel satinato / satin nickel	x
30-	nickel lucido / polished nickel	x

*PREZZO DI LISTINO / PRICE LIST

*NON REALIZZABILE / NOT MADE

ATTENZIONE! 13-OTTONE NATURALE e 88-OTTONE SISAL: finiture non protette che antichizzano naturalmente ossidando a contatto con l'umidità atmosferica.
WARNING! 13-NATURAL BRASS and 88-SISAL BRASS: unprotected finishes that naturally oxidise in contact with atmospheric humidity.

PROGETTO SU MISURA: RICHIESTE SPECIALI

I tecnici di Bellosta Rubinetterie sono, inoltre, a disposizione di architetti e designers, per offrire un servizio esclusivo: personalizzazioni di elementi in funzione di specifiche richieste estetiche o problematiche legate a vincoli progettuali, verifica della fattibilità attraverso opportuni studi CAD e sviluppo del disegno tecnico del prodotto speciale richiesto.

Per informazioni e richieste **PROGETTI SU MISURA:**
ufficiotecnico@bellostarubinetterie.com



PROGETTO SU MISURA: SPECIAL REQUESTS

Engineers Bellosta Rubinetterie are also available to architects and designers, to offer an exclusive service: customizations of items according to specific aesthetic requirements or issues related to design constraints, verification of the feasibility studies and development through appropriate CAD technical design the required special product. For information and requests "SU MISURA" PROJECTS:
ufficiotecnico@bellostarubinetterie.com

CONSIGLIO TECNICO

Tutti i miscelatori della collezione NOEL vengono collaudati nel loro funzionamento al momento dell'assemblaggio. Per garantire la durata delle cartucce nel tempo, si consiglia di spurgare bene l'impianto idraulico prima del montaggio (per rimuovere eventuali detriti) e di installare rubinetti sottolavabo con filtro (art. 020 o 020/1)

N.B.: Qualora il piano lavabo avesse uno spessore superiore a 2,5 cm specificare la misura al momento dell'ordine.

TECHNICAL ADVICE

All mixers of the NOEL collection are perfectly tested. To guarantee the perfect functionality of the cartridge for a long time, we advise to clean the sanitary plant before installing the mixer. Moreover we advise to install angle valve with filter (art. 020 or 020/1).

Attention: If the lavatory top is more than cm 2,5 hick, please point it out when placing the order.

FORATURA DEI PIANI SANITARI

I miscelatori lavabo/bidet monoforo prevedono un foro di diametro 35 mm nel piano sanitario.

MONOFORO >>

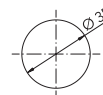

DRILLING PLANS HEALTH

The sink / hole bidet mixers provide a hole diameter of 35 mm in the health plan.

SCHEMA FUNZIONAMENTO DEVIATORI INCASSO 2/3/4 USCITE

Questi deviatori non hanno funzione di chiusura. Ruotando verso destra o sinistra si attivano le uscite. Tra 2 uscite adiacenti durante la rotazione diminuisce la portata dell'uscita iniziale ed incrementa quella della successiva. In posizione intermedia sono entrambe attive a pari portata.

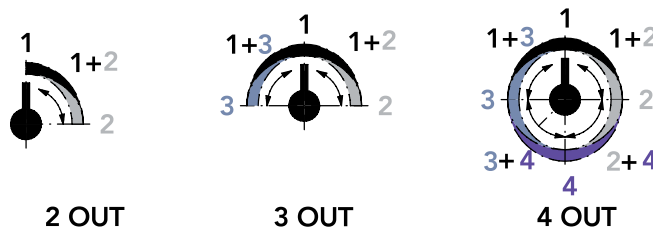

SCHEME OPERATION SWITCHES FLUSH OUTPUT 2/3/4

These diverters have not closing function. By turning to the right or left activates the outputs. Between two adjacent outputs during the rotation decreases the initial output flow and increases that of the next. In position intermediate are both active at the same flow rate.

ATTENZIONE:

nel caso di installazione del miscelatore NOEL su sanitari o mobili dotati di spalletta posteriore (es. serie Canova di Catalano) è necessario controllare le misure di ingombro ed utilizzare eventualmente gli articoli 1505/PC e 1507/PC.

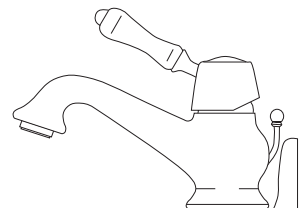

ATTENTION:

when installing a NOEL mixer on sanitarries or furnitures having a back shoulder (see picture - for exemple: serie Canova of Catalano), it is necessary to check the obstruction and use the articles 1505/PC and 1507/PC.

Tutta la serie NOËL è disponibile anche con il particolare della leva in legno (noce).

The NOËL collection is available with lever in wood finish too (walnut).



LEGENDA SIMBOLI

**ACCESSORI
ACCESSORIES**



SCARICO C/TAPPO A PRESSIONE

WASTE WITH PRESSURE CAP

**RICAMBI IMMEDIATI
IMMEDIATE PARTS**



CARTUCCIA CARTRIDGE



CARTUCCIA DEVIATRICE DIVERTER CARTRIDGE



CARTUCCIA TERMOSTATICA THERMOSTATIC CARTRIDGE



DEVIATORE DIVERTER



VITONE CERAMICO CERAMIC VALVE



AERATORE TONDO ROUND AERATOR



VITONE TRADIZIONALE TRADITIONAL VALVE



AERATORE PIATTO FLAT AERATOR

LAVABO



1505	pag. 531
1505/LL	pag. 531

MISCELATORE LAVABO MONOFORO
BASIN MIXER



1505/S	pag. 531
1505/S/LL	pag. 531

MISCELATORE LAVABO MONOFORO
BASIN MIXER



1505/PC	pag. 531
1505/PC/LL	pag. 531

MISCELATORE LAVABO MONOFORO
BASIN MIXER



1505/L	pag. 531
1505/L/LL	pag. 531

MISCELATORE LAVABO MONOFORO
BASIN MIXER

BIDET



1507	pag. 531
1507/LL	pag. 531

MISCELATORE BIDET MONOFORO
BIDET MIXER



1507/S	pag. 532
1507/S/LL	pag. 532

MISCELATORE BIDET MONOFORO
BIDET MIXER



1507/PC	pag. 532
1507/PC/LL	pag. 532

MISCELATORE BIDET MONOFORO
BIDET MIXER



1507/L	pag. 532
1507/L/LL	pag. 532

MISCELATORE BIDET MONOFORO
BIDET MIXER

DOCCIA INCASSO



1521/E + 104018	pag. 532
1521/E/LL + 104018	pag. 532

MISCELATORE INCASSO
BUILT-IN MIXER

parti esterne / external parts: 1521/E | 1521/E/LL
parte incasso / built-in part: 104018



1521/K/E + 104018	pag. 532
1521/K/E/LL + 104018	pag. 532

MISCELATORE INCASSO
BUILT-IN MIXER

parti esterne / external parts: 1521/K/E | 1521/K/E/LL
parte incasso / built-in part: 104018



1500/E + 104002	pag. 533
1500/E/LL + 104002	pag. 533

MISCELATORE INCASSO C/DEVIATORE 2 USCITE
BUILT-IN MIXER WITH DIVERTER 2 OUT

parti esterne / external parts: 1500/E | 1500/E/LL
parte incasso / built-in part: 104002



1500/K/E + 104002	pag. 533
1500/K/E/LL + 104002	pag. 533

MISCELATORE INCASSO C/DEVIATORE 2 USCITE
BUILT-IN MIXER WITH DIVERTER 2 OUT

parti esterne / external parts: 1500/K/E | 1500/K/E/LL
parte incasso / built-in part: 104002

DEVIATORI INCASSO



0803/2/1/L/E + 914016	pag. 533
0803/2/1/LLE + 914016	pag. 533

DEVIATORE INCASSO 2 USCITE
BUILT-IN DIVERTER 2 OUT

parti esterne / external parts: 0803/2/1/L/E | 0803/2/1/LLE
parte incasso / built-in part: 914016



0803/2K/L/E + 914016	pag. 533
0803/2K/LL/E + 914016	pag. 533

DEVIATORE INCASSO 2 USCITE
BUILT-IN DIVERTER 2 OUT

parti esterne / external parts: 0803/2K/L/E | 0803/2K/LL/E
parte incasso / built-in part: 914016



0803/3/1/L/E + 034127	pag. 533
0803/3/1/LLE + 034127	pag. 533

DEVIATORE INCASSO 3 USCITE
BUILT-IN DIVERTER 3 OUT

parti esterne / external parts: 0803/3/1/L/E | 0803/3/1/LLE
parte incasso / built-in part: 034127



0803/3K/L/E + 034127	pag. 534
0803/3K/LL/E + 034127	pag. 534

DEVIATORE INCASSO 3 USCITE
BUILT-IN DIVERTER 3 OUT

parti esterne / external parts: 0803/3K/L/E | 0803/3K/LL/E
parte incasso / built-in part: 034127

DEVIATORI INCASSO



0803/4/1/L/E + 034128 pag. **534**
0803/4/1/LL/E + 034128 pag. **534**
 DEVIATORE INCASSO 4 USCITE
 BUILT-IN DIVERTER 4 OUT
 parti esterne / external parts: 0803/4/1/L/E | 0803/4/1/LL/E
 parte incasso / built-in part: 034128



0803/4K/L/E + 034128 pag. **534**
0803/4K/LL/E + 034128 pag. **534**
 DEVIATORE INCASSO 4 USCITE
 BUILT-IN DIVERTER 4 OUT
 parti esterne / external parts: 0803/4K/L/E | 0803/4K/LL/E
 parte incasso / built-in part: 034128

DOCCIA INCASSO TERMOSTATICO



1312/H/K/E + 484020 pag. **233***
 MISCELATORE TERMOSTATICO INCASSO 1 USCITA
 BUILT-IN THERMOSTATIC MIXER 1 OUT
 parti esterne / external parts: 1312/H/K/E
 parte incasso / built-in part: 484020



1312/2/K/E + 484021 pag. **233***
 MISCELATORE TERMOSTATICO INCASSO
 C/DEVIATORE 2 USCITE
 BUILT-IN THERMOSTATIC MIXER WITH DIVERTER
 2 OUT
 parti esterne / external parts: 1312/2/K/E
 parte incasso / built-in part: 484021



1312/3/K/E + 484022 pag. **233***
 MISCELATORE TERMOSTATICO INCASSO
 C/DEVIATORE 3 USCITE
 BUILT-IN THERMOSTATIC MIXER WITH DIVERTER
 3 OUT
 parti esterne / external parts: 1312/3/K/E
 parte incasso / built-in part: 484022



1312/4/K/E + 484023 pag. **233***
 MISCELATORE TERMOSTATICO INCASSO
 C/DEVIATORE 4 USCITE
 BUILT-IN THERMOSTATIC MIXER WITH DIVERTER
 4 OUT
 parti esterne / external parts: 1312/4/K/E
 parte incasso / built-in part: 484023

DOCCIA ESTERNO



1509/1 pag. **534**
1509/1/LL pag. **534**
 MISCELATORE DOCCIA ESTERNO
 EXTERNAL SHOWER MIXER

DOCCIA ESTERNO TERMOSTATICO



1511/1A pag. **535**
1511/1A/LL pag. **535**
 MISCELATORE DOCCIA ESTERNO TERMOSTATICO
 EXTERNAL SHOWER THERMOSTATIC MIXER



1511/4A pag. **535**
1511/4A/LL pag. **535**
 MISCELATORE DOCCIA ESTERNO TERMOSTATICO
 C/STELO
 EXTERNAL SHOWER THERMOSTATIC MIXER WITH
 PIPE



1511/5A pag. **535**
1511/5A/LL pag. **535**
 MISCELATORE DOCCIA ESTERNO TERMOSTATICO
 C/STELO COMPLETO
 EXTERNAL SHOWER THERMOSTATIC MIXER WITH
 COMPLETE PIPE

DOCCIA COMPLEMENTI



0303/1/A pag. **132***
0303/1/A/LL pag. **132***
 SUPPORTO DOCCIA COMPLETO
 FULL SHOWER SUPPORT



0303/1K/A pag. **132***
0303/1K/A/LL pag. **132***
 SUPPORTO DOCCIA COMPLETO
 FULL SHOWER SUPPORT



0303/1 pag. **132***
0303/1/LL pag. **132***
 SUPPORTO DOCCIA DUPLEX COMPLETO
 DUPLEX FULL SHOWER SUPPORT



1530 pag. **141***
1530/LL pag. **141***
 SALISCENDI COMPLETO C/PRESA D'ACQUA
 COMPLETE WALL PIPE WITH WATER CONNECTION

* ABBINAMENTO CONSIGLIATO: PER PREZZI E SCHEDE TECNICHE, VEDI RIFERIMENTO PAGINA LISTINO REVIVRE
 * RECOMMENDED COMBINATION: FOR PRICES AND TECHNICAL DETAILS, LOOK AT PAGE WITH REFERENCE REVIVRE PRICE



DOCCIA COMPLEMENTI



0830/1/L	pag. 145*
0830/1/LL	pag. 145*

ASTA SALISCENDI
WALL PIPE



0513/4	pag. 149*
--------	-----------

STELO DOCCIA
ROD SHOWER



0313/5/1	pag. 150*
0313/5/1/LL	pag. 150*

CURVA PRESA ACQUA C/STELO COMPLETO
CURVE WATER CONNECTOR WITH COMPLETE ROD

VASCA



1501/A	pag. 535
1501/A/LL	pag. 535

MISCELATORE VASCA ESTERNO
EXTERNAL BATH MIXER



1501/2	pag. 535
1501/2/LL	pag. 535

MISCELATORE PER BORDO VASCA
BATH RIM MIXER



1501/20	pag. 536
1501/20/LL	pag. 536

MISCELATORE PER BORDO VASCA S/BOCCA
BATH RIM MIXER WITHOUT SPOUT



1003	pag. 536
------	----------

BOCCA VASCA DA PARETE
WALL BATH SPOUT

BAGNO COMPLEMENTI



1508/E + 104020 o 104021	pag. 536
--------------------------	----------

RUBINETTO D'ARRESTO 1/2"
BUILT-IN STOP COCK 1/2"

parti esterne / external parts: 1508/E
parte incasso / built-in part: 104020 DX o 104021 SX



1508/E + 104022 o 104023	pag. 536
--------------------------	----------

RUBINETTO D'ARRESTO 3/4"
BUILT-IN STOP COCK 3/4"

parti esterne / external parts: 1508/E
parte incasso / built-in part: 104022 DX o 104023 SX



0840/L/E + 884053	pag. 536
0840/LL/E + 884053	pag. 536

PASSO RAPIDO 3/4"
BUILT-IN RAPID FLOW COCK 3/4"

parti esterne / external parts: 0840/L/E | 0840/LL/E
parte incasso / built-in part: 884053



0840/K/L/E + 884053	pag. 537
0840/K/LL/E + 884053	pag. 537

PASSO RAPIDO 3/4"
BUILT-IN RAPID FLOW COCK 3/4"

parti esterne / external parts: 0840/K/L/E | 0840/K/LL/E
parte incasso / built-in part: 884053



0840/L/E + 884054	pag. 537
0840/LL/E + 884054	pag. 537

PASSO RAPIDO 1"
BUILT-IN RAPID FLOW COCK 1"

parti esterne / external parts: 0840/L/E | 0840/LL/E
parte incasso / built-in part: 884054



0840/K/L/E + 884054	pag. 537
0840/K/LL/E + 884054	pag. 537

PASSO RAPIDO 1"
BUILT-IN RAPID FLOW COCK 1"

parti esterne / external parts: 0840/K/L/E | 0840/K/LL/E
parte incasso / built-in part: 884054



0832/2/L/E + 035212	pag. 537
0832/2/LL/E + 035212	pag. 537

SARACINESCA
GATE VALVE

parti esterne / external parts: 0832/2/L/E | 0832/2/LL/E
parte incasso / built-in part: 035212



0832/2/K/L/E + 035212	pag. 537
0832/2/K/LL/E + 035212	pag. 537

SARACINESCA
GATE VALVE

parti esterne / external parts: 0832/2/K/L/E | 0832/2/K/LL/E
parte incasso / built-in part: 035212

* ABBINAMENTO CONSIGLIATO: PER PREZZI E SCHEDE TECNICHE, VEDI RIFERIMENTO PAGINA LISTINO REVIVRE

* RECOMMENDED COMBINATION: FOR PRICES AND TECHNICAL DETAILS, LOOK AT PAGE WITH REFERENCE REVIVRE PRICE

1505

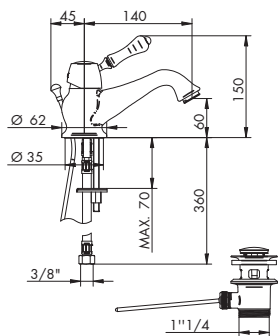

MISCELATORE LAVABO MONOFORO

- > cartuccia tradizionale
- > interasse bocca 140
- > flessibili di alimentazione
- > con scarico

 025003

p. 149

 034005

p. 140

CROMATO

01-1505 leva porcellana

01-1505/LL leva legno noce

ALTRE FINITURE

XX-1505 leva porcellana x M*

XX-1505/LL leva legno noce x M*

1505/S

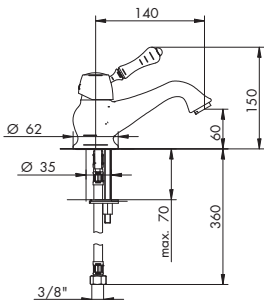

MISCELATORE LAVABO MONOFORO

- > cartuccia tradizionale
- > interasse bocca 140
- > flessibili di alimentazione
- > senza scarico

 0136 - 0136/1

p. 717

 025003

p. 149

 034005

p. 140

CROMATO

01-1505/S leva porcellana

01-1505/S/LL leva legno noce

ALTRE FINITURE

XX-1505/S leva porcellana x M*

XX-1505/S/LL leva legno noce x M*

1505/PC

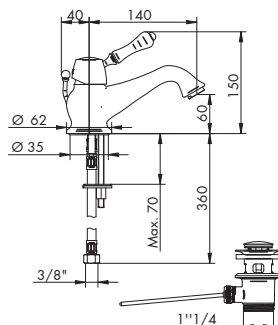

MISCELATORE LAVABO MONOFORO

- > cartuccia tradizionale
- > interasse bocca 140
- > flessibili di alimentazione
- > con scarico
- > pomolo tipo Catalano

 025003

p. 149

 034005

p. 140

CROMATO

01-1505/PC leva porcellana

01-1505/PC/LL leva legno noce

ALTRE FINITURE

XX-1505/PC leva porcellana € x M*

XX-1505/PC/LL leva legno noce € x M*

1505/L

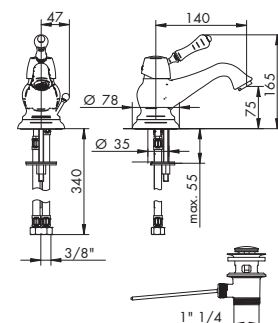

MISCELATORE LAVABO MONOFORO

- > cartuccia tradizionale
- > interasse bocca 140
- > flessibili di alimentazione
- > con scarico
- > pomolo laterale (mod. Malcomini)

 025003

p. 149

 034005

p. 140

CROMATO

01-1505/L leva porcellana €

01-1505/L/LL leva legno noce €

ALTRE FINITURE

XX-1505/L leva porcellana € x M*

XX-1505/L/LL leva legno noce € x M*

1507

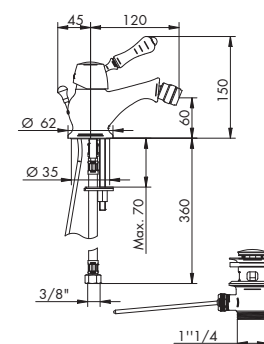

MISCELATORE BIDET MONOFORO

- > cartuccia tradizionale
- > interasse bocca 120
- > aeratore snodato
- > flessibili di alimentazione
- > con scarico

 025003

p. 149

 034008

p. 140

CROMATO

01-1507 leva porcellana €

01-1507/LL leva legno noce €

ALTRE FINITURE

XX-1507 leva porcellana € x M*

XX-1507/LL leva legno noce € x M*

ACCESSORI



RICAMBI IMMEDIATI



XX = CODICE FINITURA RICHIESTA: per identificare codice corretto vedi pag. 526
 M* = MOLTIPLICATORE: per calcolare il prezzo delle altre finiture vedi tabella pag. 526

1507/S

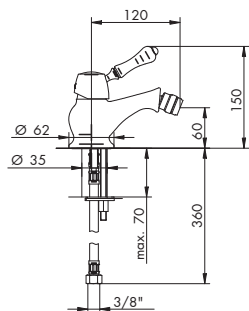

MISCELATORE BIDET MONOFORO

- > cartuccia tradizionale
- > interasse bocca 120
- > aeratore snodato
- > flessibili di alimentazione
- > senza scarico

	0136 - 0136/1	p. 717
	025003	p. 149
	034008	p. 140

CROMATO

01-1507/S	leva porcellana	€
01-1507/S/LL	leva legno noce	€

ALTRE FINITURE

XX-1507/S	leva porcellana	€	x M*
XX-1507/S/LL	leva legno noce	€	x M*

1507/PC

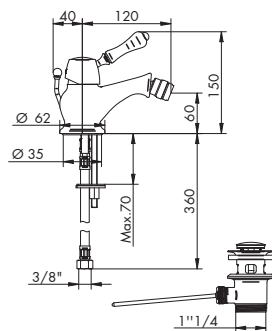

MISCELATORE BIDET MONOFORO

- > cartuccia tradizionale
- > interasse bocca 120
- > aeratore snodato
- > flessibili di alimentazione
- > con scarico
- > pomolo tipo Catalano

	025003	p. 149
	034008	p. 140

CROMATO

01-1507/PC	leva porcellana	€
01-1507/PC/LL	leva legno noce	€

ALTRE FINITURE

XX-1507/PC	leva porcellana	€
XX-1507/PC/LL	leva legno noce	€

1507/L

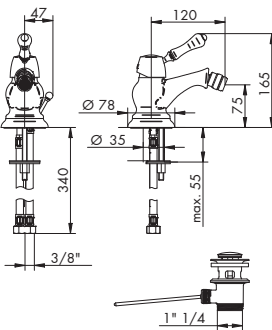

MISCELATORE BIDET MONOFORO

- > cartuccia tradizionale
- > interasse bocca 120
- > aeratore snodato
- > flessibili di alimentazione
- > con scarico
- > pomolo laterale (mod. Malcomini)

	025003	p. 149
	034008	p. 140

CROMATO

01-1507/L	leva porcellana	€
01-1507/L/LL	leva legno noce	€

ALTRE FINITURE

XX-1507/L	leva porcellana	€
XX-1507/L/LL	leva legno noce	€

1521/E + 104018

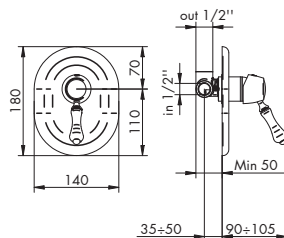

MISCELATORE INCASSO

- > cartuccia tradizionale
- > attacchi da 1/2"
- > uscita superiore
- > incasso con B-Box

	025002	p. 149
--	--------	--------

CROMATO

01-1521/E	leva porcellana	€
01-1521/LL/E	leva legno noce	€

ALTRE FINITURE

XX-1521/E	leva porcellana	€
XX-1521/LL/E	leva legno noce	€

PARTE INCASSO

01-104018	info pag. 36	€
-----------	--------------	---

PREZZO TOTALE	€
---------------	---

1521/K/E + 104018

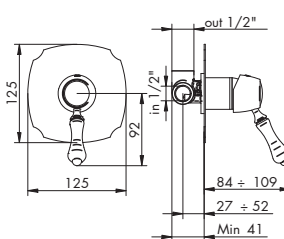

MISCELATORE INCASSO

- > cartuccia tradizionale
- > attacchi da 1/2"
- > uscita superiore
- > incasso con B-Box
- > piastra classic

	025002	p. 149
--	--------	--------

CROMATO

01-1521/K/E	leva porcellana	€
01-1521/K/LL/E	leva legno noce	€

ALTRE FINITURE

XX-1521/K/E	leva porcellana	€
XX-1521/K/LL/E	leva legno noce	€

PARTE INCASSO

01-104018	info pag. 36	€
-----------	--------------	---

PREZZO TOTALE	€
---------------	---

1500/E + 104002

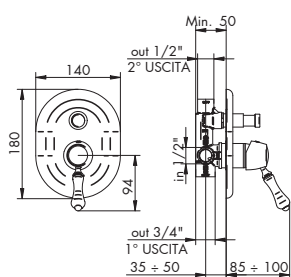

MISCELATORE INCASSO C/DEVIATORE 2 USCITE

- > cartuccia tradizionale
- > deviatore a pressione 2 uscite c/ritorno automatico e blocco meccanico basse pressioni
- > attacchi da 1/2"
- > uscita principale inferiore da 3/4"
- > incasso con B-Box

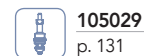

CROMATO

01-1500/E leva porcellana €
01-1500/LL/E leva legno noce €

ALTRE FINITURE

XX-1500/E leva porcellana €
XX-1500/LL/E leva legno noce €

PARTE INCASSO

01-104002 info pag. 37 €

PREZZO TOTALE €

1500/K/E + 104002

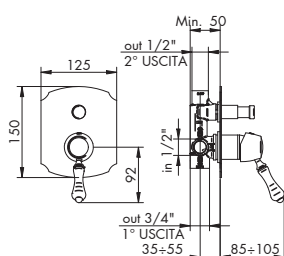

MISCELATORE INCASSO C/DEVIATORE 2 USCITE

- > cartuccia tradizionale
- > deviatore a pressione 2 uscite c/ritorno automatico e blocco meccanico basse pressioni
- > attacchi da 1/2"
- > uscita principale inferiore da 3/4"
- > incasso con B-Box > piastra classic



CROMATO

01-1500/K/E leva porcellana € 168,00
01-1500/K/LL/E leva legno noce € 168,00

ALTRE FINITURE

XX-1500/K/E leva porcellana € 168,00 x M*
XX-1500/K/LL/E leva legno noce € 168,00 x M*

PARTE INCASSO

01-104002 info pag. 37 €

PREZZO TOTALE €

0803/2/1/L/E + 914016

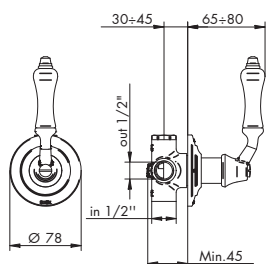

DEVIATORE INCASSO 2 USCITE

- > deviatore a dischi ceramici 2 uscite senza chiusura
- > attacchi da 1/2"

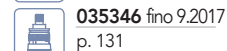

CROMATO

01-0803/2/1/L/E leva porcellana €
01-0803/3/1/LL/E leva legno noce €

ALTRE FINITURE

XX-0803/2/1/L/E leva porcellana €
XX-0803/3/1/LL/E leva legno noce €

PARTE INCASSO

914016 info pag. 38 €

PREZZO TOTALE €

0803/2K/L/E + 914016

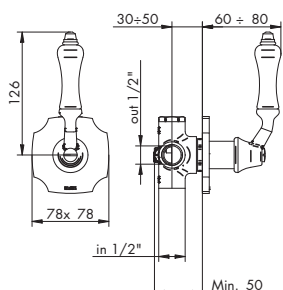

DEVIATORE INCASSO 2 USCITE

- > deviatore a dischi ceramici 2 uscite senza chiusura
- > attacchi da 1/2"
- > piastra classic

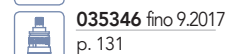

CROMATO

01-0803/2K/L/E leva porcellana €
01-0803/2K/LL/E leva legno noce €

ALTRE FINITURE

XX-0803/2K/L/E leva porcellana €
XX-0803/2K/LL/E leva legno noce €

PARTE INCASSO

914016 info pag. 38 €

PREZZO TOTALE €

0803/3/1/L/E + 034127

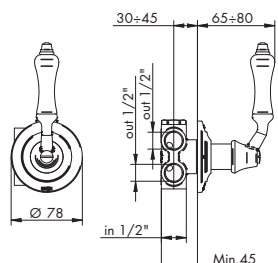

DEVIATORE INCASSO 3 USCITE

- > deviatore a dischi ceramici 3 uscite senza chiusura
- > attacchi da 1/2"

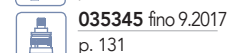

CROMATO

01-0803/3/1/L/E leva porcellana €
01-0803/3/1/LL/E leva legno noce €

ALTRE FINITURE

XX-0803/3/1/L/E leva porcellana €
XX-0803/3/1/LL/E leva legno noce €

PARTE INCASSO

034127 info pag. 38 €

PREZZO TOTALE €

RICAMBI IMMEDIATI



XX = CODICE FINITURA RICHIESTA: per identificare codice corretto vedi pag. 526
M* = MOLTIPLICATORE: per calcolare il prezzo delle altre finiture vedi tabella pag. 526

0803/3K/L/E + 034127

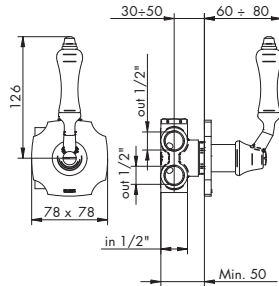

DEVIATORE INCASSO 3 USCITE

- > deviatore a dischi ceramici 3 uscite senza chiusura
- > attacchi da 1/2"
- > piastra classic

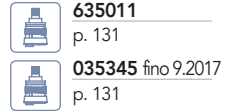

635011
p. 131

035345 fino 9.2017
p. 131

CROMATO

- 01-0803/3K/L/E leva porcellana €
- 01-0803/3K/LL/E leva legno noce €

ALTRE FINITURE

- XX-0803/3K/L/E leva porcellana €
- XX-0803/3K/LL/E leva legno noce €

PARTE INCASSO

034127 info pag. 38 €

PREZZO TOTALE €

0803/4/1/L/E + 034128

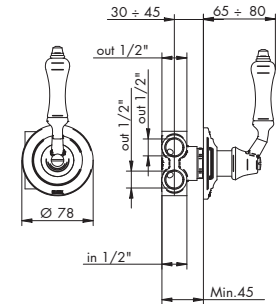

DEVIATORE INCASSO 4 USCITE

- > deviatore a dischi ceramici 4 uscite senza chiusura
- > attacchi da 1/2"

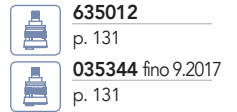

635012
p. 131

035344 fino 9.2017
p. 131

CROMATO

- 01-0803/4/1/L/E leva porcellana €
- 01-0803/4/1/LL/E leva legno noce €

ALTRE FINITURE

- XX-0803/4/1/L/E leva porcellana €
- XX-0803/4/1/LL/E leva legno noce €

PARTE INCASSO

034128 info pag. 38 €

PREZZO TOTALE €

0803/4K/L/E + 034128

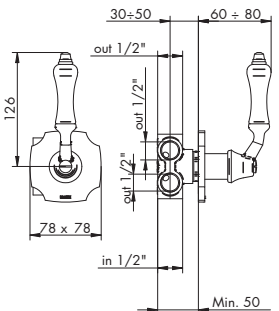

DEVIATORE INCASSO 4 USCITE

- > deviatore a dischi ceramici 4 uscite senza chiusura
- > attacchi da 1/2"
- > piastra classic

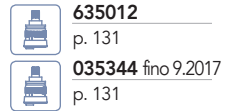

635012
p. 131

035344 fino 9.2017
p. 131

CROMATO

- 01-0803/4K/L/E leva porcellana €
- 01-0803/4K/LL/E leva legno noce €

ALTRE FINITURE

- XX-0803/4K/L/E leva porcellana €
- XX-0803/4K/LL/E leva legno noce €

PARTE INCASSO

034128 info pag. 38 €

PREZZO TOTALE €

I DOCCIA INCASSO TERMOSTATICO CONSIGLIATI SONO PRESENTI SU LISTINO REVIVRE

- 1312/K/E + 484020
- 1312/2/K/E + 484021
- 1312/3/K/E + 484022
- 1312/4/K/E + 484023

I DOCCIA COMPLEMENTI CONSIGLIATI SONO PRESENTI SU LISTINO REVIVRE

- 0303/1/A 0830/1/L
- 0303/1 0513/4
- 0303/1K/A 0313/5/1
- 1530

1509/1

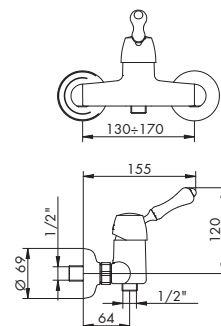

MISCELATORE DOCCIA ESTERNO

- > cartuccia tradizionale
- > senza set doccia
- > attacchi da 1/2"



025003
p. 149

CROMATO

- 01-1509/1 leva porcellana €
- 01-1509/1/LL leva legno noce €

ALTRE FINITURE

- XX-1509/1 leva porcellana €
- XX-1509/1/LL leva legno noce €

1511/1A

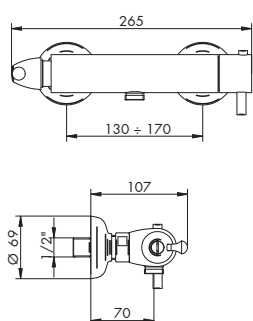

MISCELATORE DOCCIA ESTERNO TERMOSTATICO

- > cartuccia termostatica
- > vitone ceramico 90°
- > senza set doccia
- > attacchi da 1/2"

 885041
p. 150

 055002
p. 151

CROMATO

01-1511/1A

€

ALTRE FINITURE

XX-1511/1A

€

x M*

1511/4A

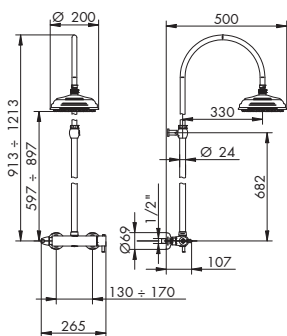

MISCELATORE DOCCIA ESTERNO TERMOSTATICO C/STELO

- > cartuccia termostatica
- > stelo regolabile
- > soffione orientabile Ø200 in ottone senza anticalcare
- > attacchi da 1/2"

 885041
p. 150

 055002
p. 151

CROMATO

01-1511/4A

€

ALTRE FINITURE

XX-1511/4A

€

x M*

1511/5A

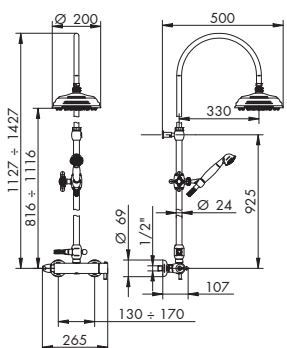

MISCELATORE DOCCIA ESTERNO TERMOSTATICO C/STELO COMPLETO

- > cartuccia termostatica
- > deviatore a trazione c/ritorno automatico e blocco meccanico bassa pressione
- > soffione Ø200 in ottone senza anticalcare
- > flessibile in ottone 150 cm
- > attacchi da 1/2"
- > doccetta monogetto in metallo senza anticalcare Ø52
- > stelo regolabile
- > supporto doccetta scorrevole
- > maniglia a croce

 885041
p. 150

 055002
p. 151

 035303
p. 130

CROMATO

01-1511/5A

€

ALTRE FINITURE

XX-1511/5A

€

x M*

1501/A

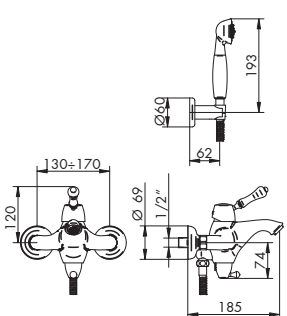

MISCELATORE VASCA ESTERNO

- > cartuccia tradizionale
- > interasse bocca 185
- > deviatore manuale senza ritorno automatico
- > flessibile in metallo 150 cm
- > supporto a parete fisso
- > attacchi da 1/2"
- > doccetta monogetto in metallo senza anticalcare Ø52

 025003
p. 149

 034005
p. 140

CROMATO

01-1501/A

leva porcellana €

01-1501/A/LL

leva legno noce €

ALTRE FINITURE

XX-1501/A leva porcellana €

XX-1501/A/LL leva legno noce €

1501/2

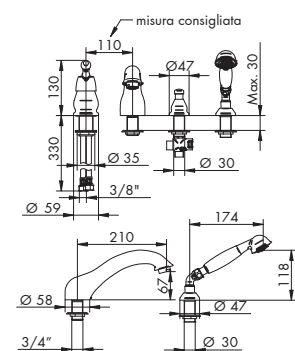

MISCELATORE PER BORDO VASCA

- > cartuccia tradizionale
- > interasse bocca 210
- > deviatore a pressione c/ritorno automatico
- > blocco meccanico per basse pressioni
- > flessibile in metallo 150 cm
- > flessibili di alimentazione
- > senza scarico
- > doccetta monogetto in metallo senza anticalcare Ø52
- > PREDISPOSIZIONI per bordo vasca, art. 012/4, 012/6 e 012/7, vedi pag. 615

 025002
p. 149

 724030
p. 132

 105063
p. 141

CROMATO

01-1501/2

leva porcellana €

01-1501/2/LL

leva legno noce €

ALTRE FINITURE

XX-1501/2 leva porcellana €

XX-1501/2/LL leva legno noce €

RICAMBI IMMEDIATI



XX = CODICE FINITURA RICHIESTA: per identificare codice corretto vedi pag. 526
M* = MOLTIPLICATORE: per calcolare il prezzo delle altre finiture vedi tabella pag. 526

1501/20

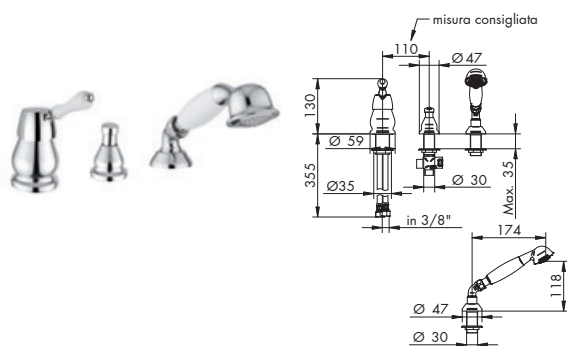

MISCELATORE PER BORDO VASCA S/BOCCA

- > cartuccia tradizionale
- > senza bocca
- > deviatore a pressione c/ritorno automatico
- > blocco meccanico per basse pressioni
- > flessibile in metallo 150 cm
- > flessibili di alimentazione
- > senza scarico
- > doccetta monogetto in metallo senza anticalcare Ø52
- > PREDISPOSIZIONI per bordo vasca, art. 012/3, 012/6 e 012/7, vedi pag. 615

	025002
	p. 149
	724030
	p. 132

CROMATO		ALTRE FINITURE	
01-1501/20	leva porcellana €	XX-1501/20	leva porcellana €
01-1501/20/LL	leva legno noce €	XX-1501/20/LL	leva legno noce €

1003

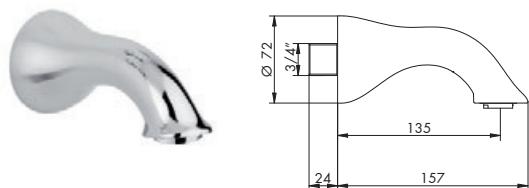

BOCCA VASCA DA PARETE

- > interasse bocca 135
- > attacchi da 3/4"

	034005
	p. 140

CROMATO		ALTRE FINITURE	
01-1003	€	XX-1003	€

1508/E + 104020 DX o 104021 SX

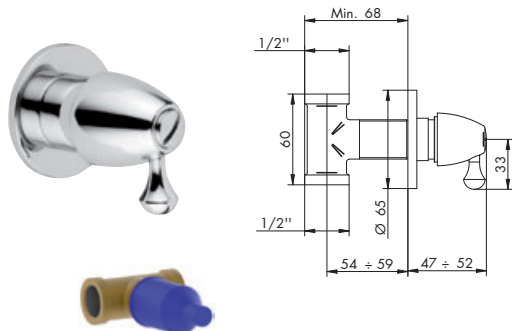

RUBINETTO D'ARRESTO 1/2"

- > vitone ceramico 90°
- > ingressi da 1/2"

	055001
	p. 151
	055002
	p. 151

PARTI ESTERNE - CROMATO		PARTI ESTERNE - ALTRE FINITURE	
01-1508/E	€	XX-1508/E	€ x M*
PARTE INCASSO			
104020 o 104021 info pag. 40 €			
PREZZO TOTALE		€	

1508/E+ 104022 DX o 104023 SX

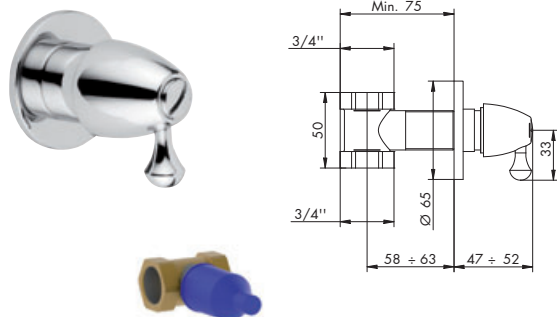

RUBINETTO D'ARRESTO 3/4"

- > vitone ceramico 90°
- > ingressi da 3/4"

	055001
	p. 151
	055002
	p. 151

PARTI ESTERNE - CROMATO		PARTI ESTERNE - ALTRE FINITURE	
01-1508/E	€	XX-1508/E	€ x M*
PARTE INCASSO			
104022 o 104023 info pag. 40 €			
PREZZO TOTALE		€	

0840/L/E + 884053

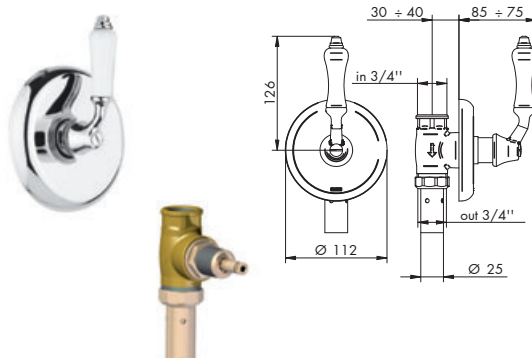

PASSO RAPIDO 3/4"

- > vitone tradizionale
- > abbinare a saracinesca
- > ingressi da 3/4"

	884021
	p. 151

CROMATO		ALTRE FINITURE	
01-0840/L/E	leva porcellana €	XX-0840/L/E	leva porcellana €
01-0840/LL/E	leva legno noce €	XX-0840/LL/E	leva legno noce €
PARTE INCASSO			
884053 info pag. 42 €			
PREZZO TOTALE		€	

0840/K/L/E + 884053

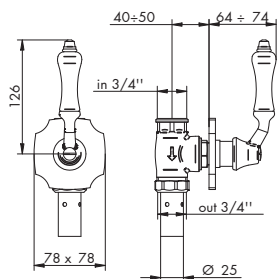

PASSO RAPIDO 3/4"

- > vitone tradizionale
- > abbinare a saracinesca
- > piastra classic
- > ingressi da 3/4"

 **884021**
p. 151

CROMATO

- | | | |
|----------------|-----------------|---|
| 01-0840/K/L/E | leva porcellana | € |
| 01-0840/K/LL/E | leva legno noce | € |

ALTRE FINITURE

- | | | |
|----------------|-----------------|---|
| XX-0840/K/L/E | leva porcellana | € |
| XX-0840/K/LL/E | leva legno noce | € |

PARTE INCASSO

884053	info pag. 42	€
--------	--------------	---

PREZZO TOTALE	€
---------------	---

0840/L/E + 884054

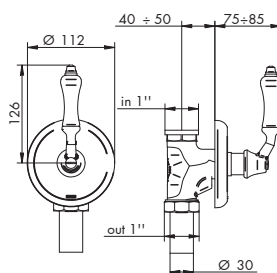

PASSO RAPIDO 1"

- > vitone tradizionale
- > abbinare a saracinesca
- > ingressi da 1"

 **884021**
p. 151

CROMATO

- | | | |
|--------------|-----------------|---|
| 01-0840/L/E | leva porcellana | € |
| 01-0840/LL/E | leva legno noce | € |

ALTRE FINITURE

- | | | |
|--------------|-----------------|---|
| XX-0840/L/E | leva porcellana | € |
| XX-0840/LL/E | leva legno noce | € |

PARTE INCASSO

884054	info pag. 42	€
--------	--------------	---

PREZZO TOTALE	€
---------------	---

0840/K/L/E + 884054

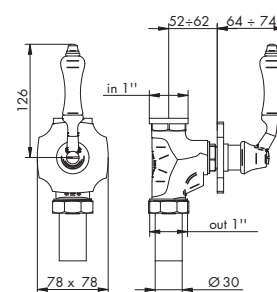

PASSO RAPIDO 1"

- > vitone tradizionale
- > abbinare a saracinesca
- > piastra classic
- > ingressi da 1"

 **884021**
p. 151

CROMATO

- | | | |
|----------------|-----------------|---|
| 01-0840/K/L/E | leva porcellana | € |
| 01-0840/K/LL/E | leva legno noce | € |

ALTRE FINITURE

- | | | |
|----------------|-----------------|---|
| XX-0840/K/L/E | leva porcellana | € |
| XX-0840/K/LL/E | leva legno noce | € |

PARTE INCASSO

884054	info pag. 42	€
--------	--------------	---

PREZZO TOTALE	€
---------------	---

0832/2/L/E + 035212

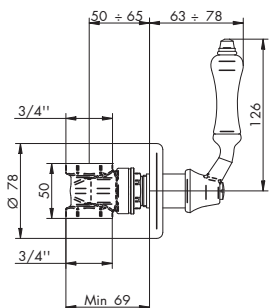

SARACINESCA

- > attacchi da 3/4"

CROMATO

- | | | |
|----------------|-----------------|---|
| 01-0832/2/L/E | leva porcellana | € |
| 01-0832/2/LL/E | leva legno noce | € |

ALTRE FINITURE

- | | | |
|----------------|-----------------|---|
| XX-0832/2/L/E | leva porcellana | € |
| XX-0832/2/LL/E | leva legno noce | € |

PARTE INCASSO

035212	info pag. 42	€
--------	--------------	---

PREZZO TOTALE	€
---------------	---

0832/2/K/L/E + 035212

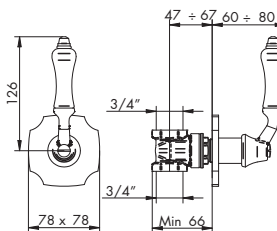

SARACINESCA

- > attacchi da 3/4"
- > piastra classic

CROMATO

- | | | |
|------------------|-----------------|---|
| 01-0832/2/K/L/E | leva porcellana | € |
| 01-0832/2/K/LL/E | leva legno noce | € |

ALTRE FINITURE

- | | | |
|------------------|-----------------|---|
| XX-0832/2/K/L/E | leva porcellana | € |
| XX-0832/2/K/LL/E | leva legno noce | € |

PARTE INCASSO

035212	info pag. 42	€
--------	--------------	---

PREZZO TOTALE	€
---------------	---