

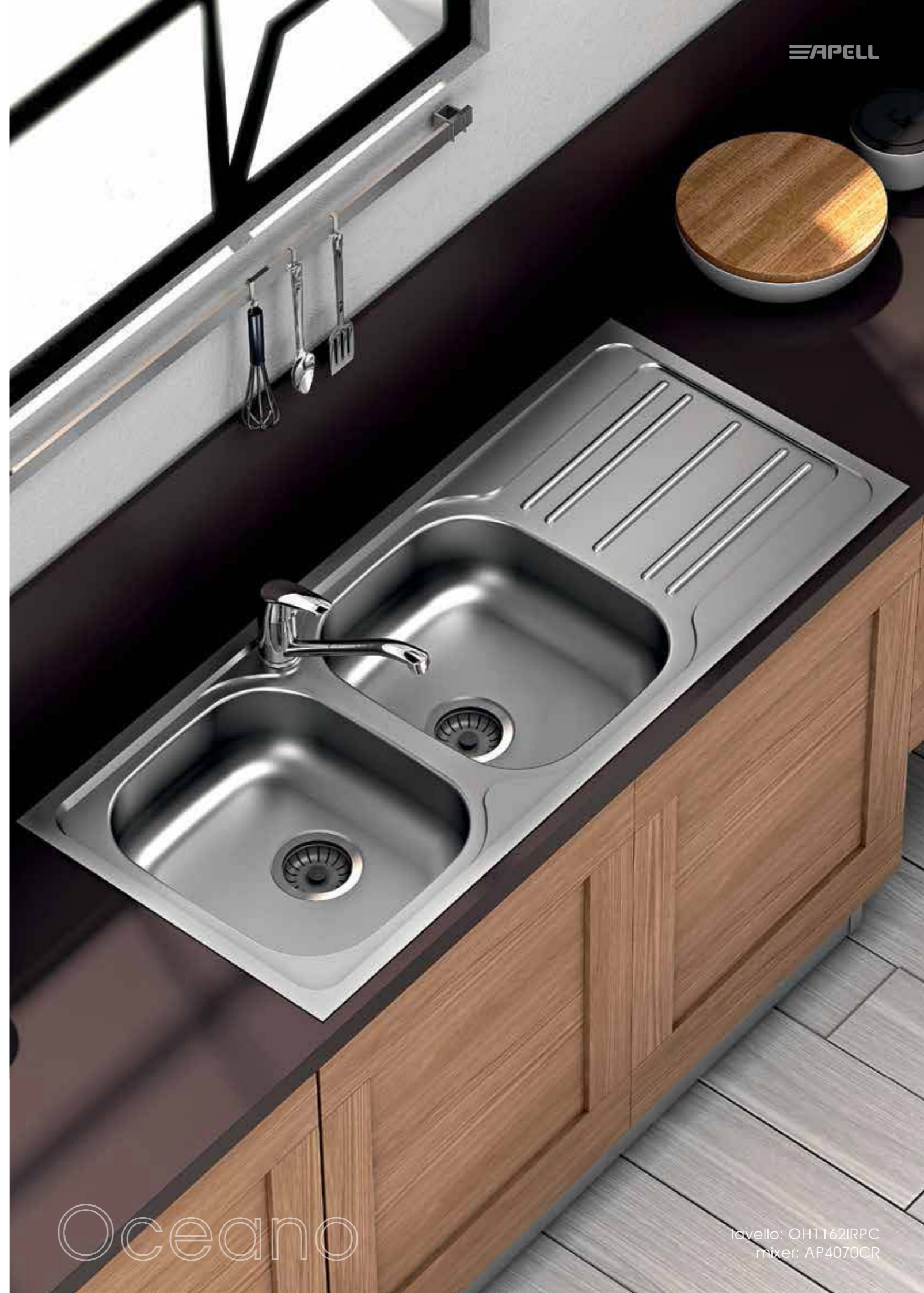















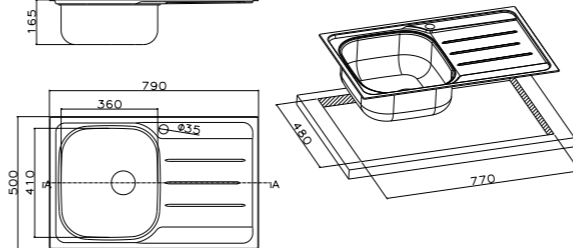







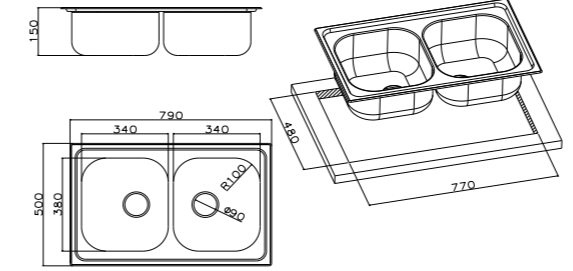

Incasso _ Built-in

Oceano è una gamma completa di lavelli che rappresenta il migliore compromesso tra funzionalità del prodotto e prezzo. La gamma è arricchita da una selezione di alcuni modelli (contraddistinti dalla sigla FH) caratterizzati dalla vasca ad alta profondità e dalla piletta di scarico da 3,5".

Oceano is a full range of sinks through which functionality and convenience find common ground. This range comprises a number of models (distinctively marked with the sign FH) with a deep bowl and a 3.5" drain.

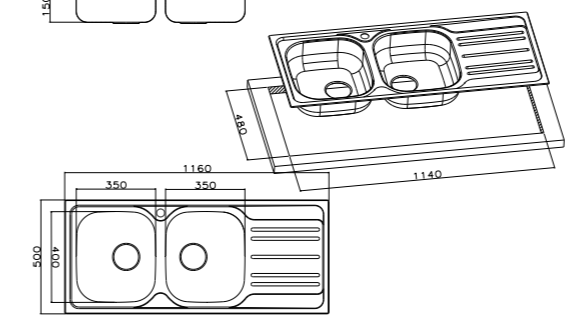

		finish/finitura	accessories	code
	<p>size 790x500mm</p> <p>drain hole 3,5"</p> <p>cut-out  770x480 mm</p> <p>base  450 mm</p> <p>depth  165 mm</p> <p>fitting  4 mm</p> <p>finish/finitura  matt / prelucido</p>	 <p> Matt/prelucido</p>	<p>extra 1 2 3</p>	<p>OH791IRPC <i>(dx/right)</i></p> <p>OH791LPC <i>(sx/left)</i></p>
<p> packed in boxes: 820 x 540 x 200 mm - 4,75 Kg</p>				
	<p>size 790x500 mm</p> <p>drain hole 3,5"</p> <p>cut-out  770x480 mm</p> <p>base  800 mm</p> <p>depth  150 mm</p> <p>fitting  4 mm</p> <p>finish/finitura  matt / prelucido</p>	 <p> Matt/prelucido</p>	<p>extra 1 2 3</p>	<p>OH792IPC</p>
<p> packed in boxes: 820 x 540 x 200 mm - 5,25 Kg</p>				
	<p>size 1160x500 mm</p> <p>drain hole 3,5"</p> <p>cut-out  1140x480 mm</p> <p>base  800 mm</p> <p>depth  150 mm</p> <p>fitting  4 mm</p> <p>finish/finitura  matt / prelucido</p>	 <p> Matt/prelucido</p>	<p>extra 1 2 3</p>	<p>OH1162IRPC <i>(sx/left)</i></p> <p>OH1162ILBC <i>(sx/left)</i></p>
<p> packed in boxes: 1180 x 520 x 200 mm - 5,75 Kg</p>				

mixers

accessories



finish/finitura

accessories

code



- size 1000x500 mm
- drain hole 3,5"
- cut-out  980x480 mm
- base  600 mm
- depth  150 mm
- fitting  4 mm
- finish/finitura  matt / prelucido

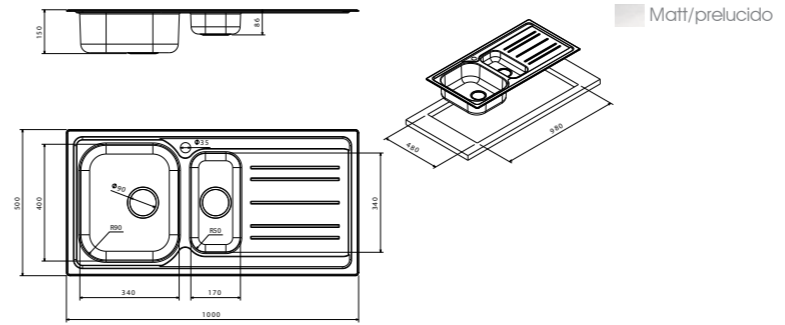

extra **1** **2** **3**

OH1002IRPC
(dx/right)

OH1002ILPC
(sx/left)

 packed in boxes:
1030 x 520 x 200 mm - 5,25 Kg



- size 500x500 mm
- drain hole 3,5"
- cut-out  480x480 mm
- base  450 mm
- depth  165 mm
- fitting  4 mm
- finish/finitura  matt/prelucido

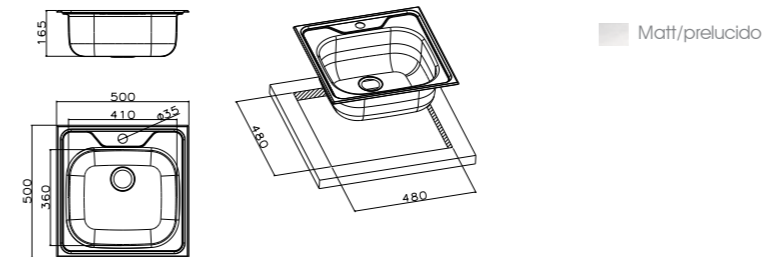

 packed in boxes:
530 x 530 x 210 mm - 3,42 Kg

OH501IPC

mixers

accessories

