

OUT DOORS

SKE2.0

GECO®

01

7 SKE 2.0 CEMENTO // **CONCRETE**

_PRIMA MATERIA

02

25 SKE 2.0 LEGNO // **WOOD**

_DECK WAY

_TEKNOWOOD

_WOOD SIDE

03

61 SKE 2.0 PIETRA // **STONE**

_ROCKS

_CARRIERE DU KRONOS

04

94 CARATTERISTICHE TECNICHE
TECHNICAL CHARACTERISTICS

100 **GECO®**

108 PEZZI SPECIALI
SPECIAL PIECES
SCALINI / *STEPS*
BORDI PISCINA / *POOL EDGE SYSTEM*

114 COLLEZIONI
COLLECTIONS

124 BORDO VINTAGE
VINTAGE EDGE

126 INDICAZIONI DI POSA
LAYING INSTRUCTION

6

dedicato all'OUTDOOR dedicated to the OUTDOOR



SKE2.0

SKE due centimetri

MONOLITICO PER ESTERNI

E COMPLEMENTI
PER LA PROGETTAZIONE

SKE two centimeter
OUTDOOR MONOLITHIC
AND SPECIAL PIECES FOR DESIGN

KRONOS PRESENTA
UNA SELEZIONE DI CEMENTI
PIETRE E LEGNI CERAMICI
IN GRES PORCELLANATO
DEDICATI IN PARTICOLARE
ALL'OUTDOOR.
SONO PAVIMENTI
CON **SPESSORE 2 CM** E
PEZZI SPECIALI PROGETTATI
PER GARANTIRE PRATICITÀ,
RESISTENZA E UN'ALTA
RESA ESTETICA
ALL'ARREDO ESTERNO,
MA NON SOLO;
SCALE, BORDI PISCINA E
FACCIAE A SORMONTO GECO.

KRONOS INTRODUCES
A SELECTION OF
CONCRETS, WOODS AND
STONES, MADE IN GRES
PORCELAIN, DEDICATED
TO OUTDOOR. THEY ARE
2CM THICKNESS PAVINGS
AND SPECIAL PIECES TO
GUARANTEE CONVENIENCE,
RESISTANCE AND AN
EXCELLENT AESTHETIC
TO OUTDOOR SPACES,
BUT NOT ONLY: STAIRS,
POOL EDGES SYSTEM AND
CLADDING WALL SYSTEM
GECO.

8

due centimetri

MONOLITICO PER ESTERNI

CONCRETE

SKE2.0

PRIMA MATERIA



CEMENTO 2.0



CENERE 2.0



SANDALO 2.0

floor

40x120, 20x120
CEMENTO 2.0

wall

29x120
CEMENTO SUNSET 3D





12

**si posa
a secco
in modo
semplice
e rapido**

**It allows for a
quick, easy and
dry installation**

floor

40x120 - 20x120

CEMENTO 2.0







floor
60x60
CEMENTO 2.0

wall
29x120
CEMENTO SUNSET 3D

pool edges
SANDALO





**floor**

60x60

CEMENTO 2.0

pool edges

SANDALO

SFIORO ESTERNO CON BORDO A CASCATA
EXTERNAL ELEVATED WATER LEVEL WITH
WATER FALL EDGE

p.111



floor, wall and stairway

40x120

CENERE 2.0

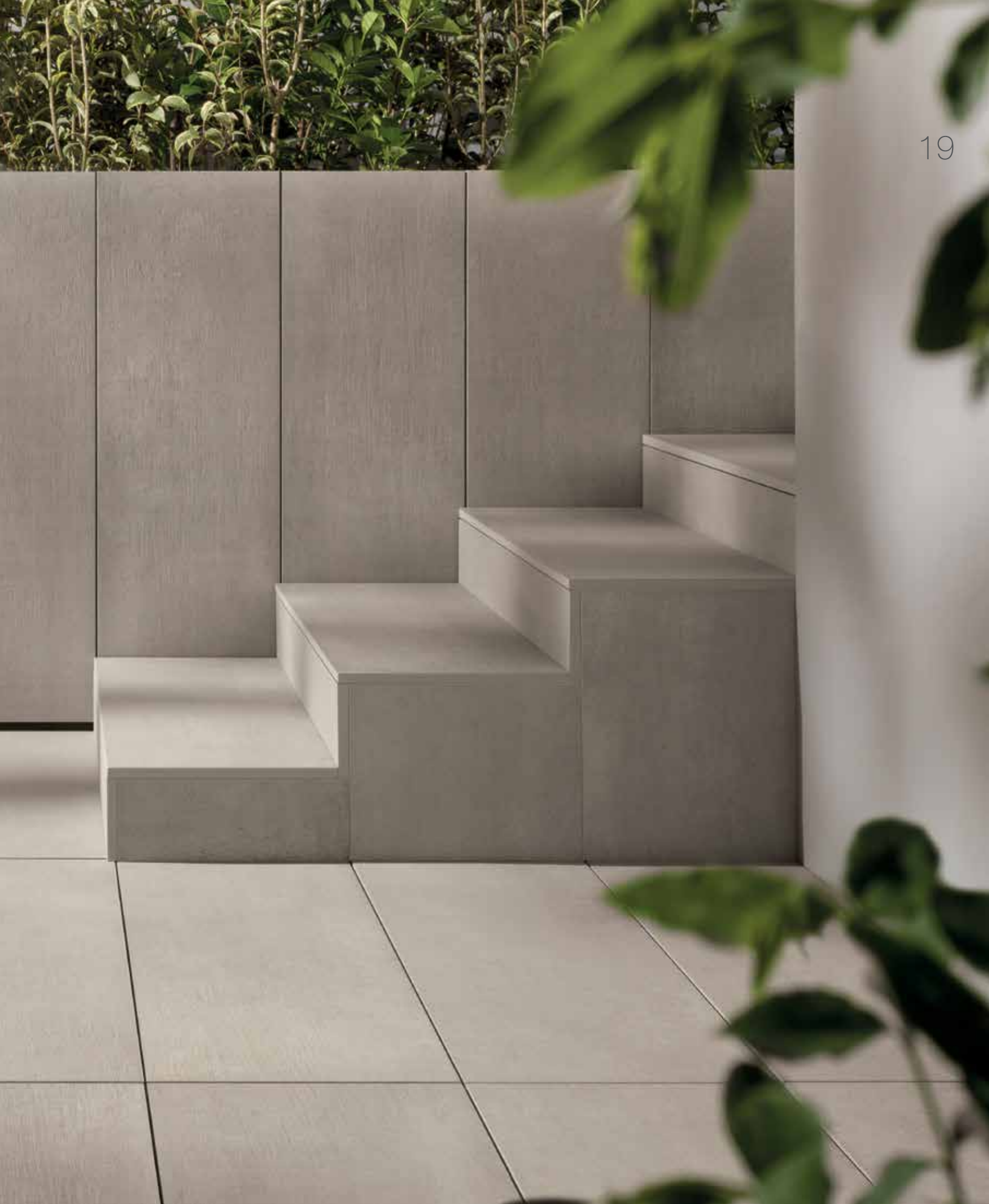

riciclabile ed ecologico

Recyclable and ecological

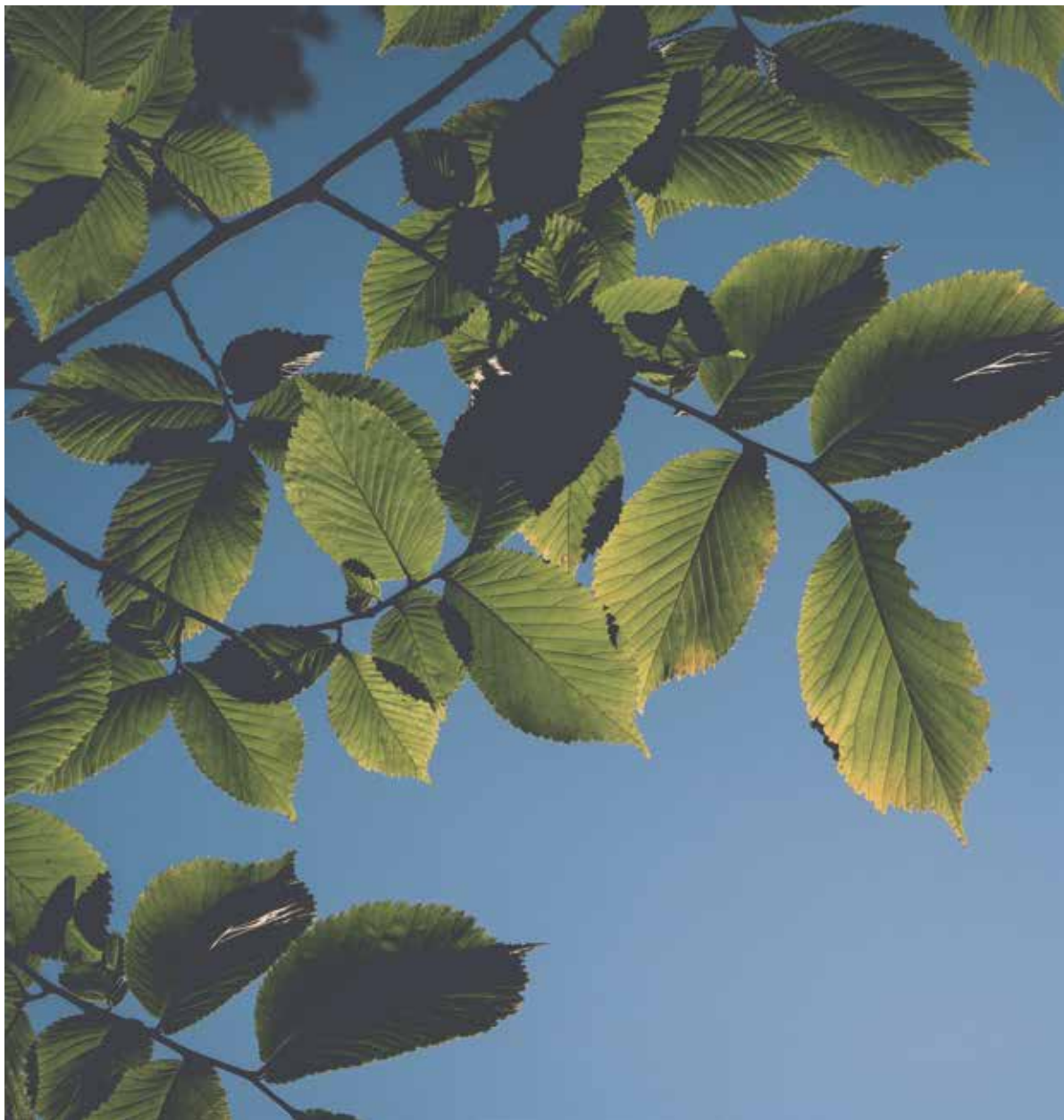

floor, wall, stairway

40x120

CENERE 2.0





floor

60x60

SANDALO 2.0

wall

29x120 SUNSET 3D

SANDALO 2.0

floor
60x60
SANDALO 2.0

wall
29x120 SUNSET 3D
SANDALO 2.0







**due
centimetri**
MONOLITICO PER ESTERNI
WOOD

SKE2.0

DECK WAY



OAK



NUT



MAPLE

WOOD SIDE



OAK DOGA 2.0



NUT DOGA 2.0



MAPLE DOGA 2.0



KAURI DOGA 2.0

TEKNOWOOD



EBANO 2.0
STRUTTURA EXTER



FAGGIO 2.0
STRUTTURA EXTER



ROVERE 2.0
STRUTTURA EXTER





LUXE
FRANCO



29

wall

30x240

NUT 1.8

floor

60x60

BRUGES 2.0

anticato rett.

30

wall

60x120
NAMUR LIGNES

floor

30x240
OAK 1.8









floor
30x240
OAK 1.8

furniture
NUT





floor

60x60

OAK DOGA 2.0

wall

26,5x180

WOODSIDE OAK

28x120

WOODSIDE KAURI

CHALET

36

pavimenti inalterati nel tempo

flooring over time

floor

20x120
OAK 2.0







floor
40x120
OAK DOGA 2.0



40

wall

29x120

OAK GECO

floor

40x120

OAK DOGA 2.0





floor
40x120
OAK DOGA 2.0





top and shelf
OAK



44

facile da pulire

easy to clean

floor

60x60

NUT DOGA 2.0





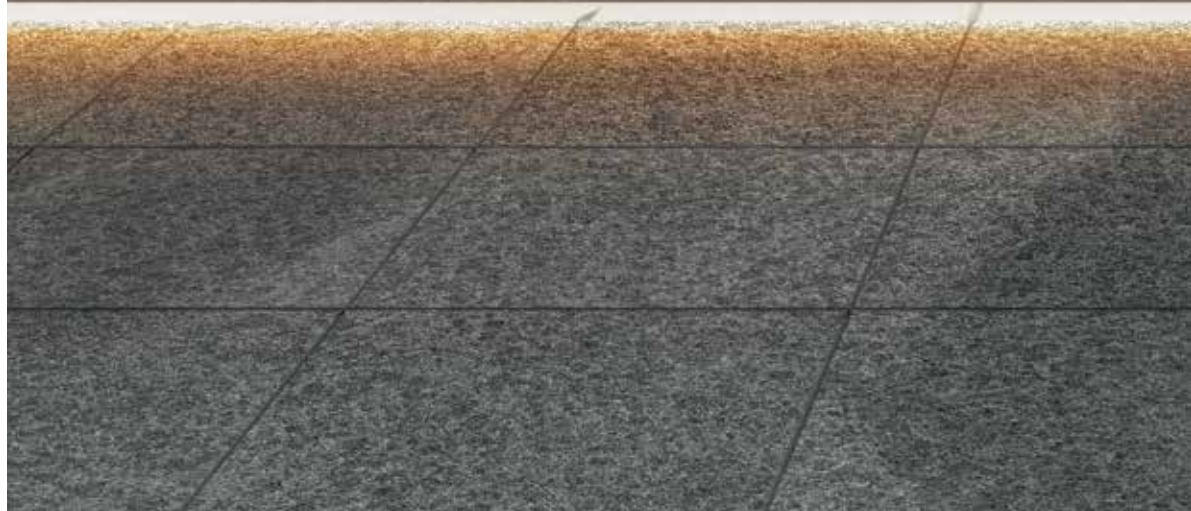

floor
20x120
NUT 2.0

60x60
BASALTO 2.0

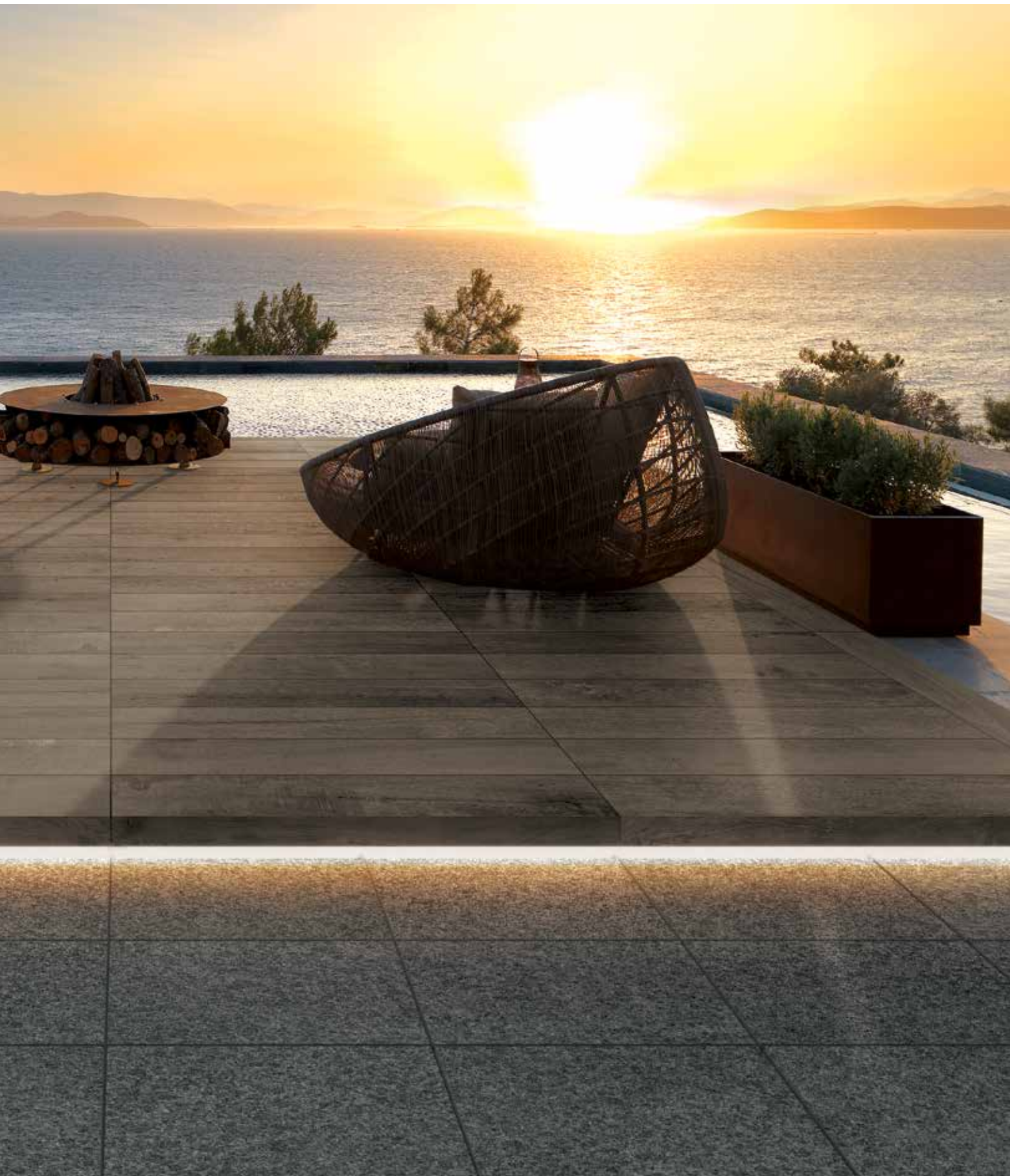



46

floor

60x60

MAPLE DOGA 2.0



floor
60x60
MAPLE DOGA 2.0

wall
26,5x180
WOODSIDE MAPLE







floor
60x60
KAURI DOGA 2.0

wall
26,5x180
WOODSIDE KAURI







floor
60x60
ROVERE 2.0 STRUTTURA EXTER

resiste agli agenti atmosferici weather-resistant

floor

60x60

FAGGIO 2.0 STRUTTURA EXTER





floor

60x60

EBANO 2.0 STRUTTURA EXTER







floor

60x60

EBANO 2.0 STRUTTURA EXTER



due
centimetri
MONOLITICO PER ESTERNI
STONE

SKE2.0

**CARRIERE
DU KRONOS**



NAMUR 2.0



GENT 2.0



BRUGES 2.0

ROCKS



SILVER WHITE 2.0



SILVER BLACK 2.0



SILVER GREY 2.0



GOLD 2.0



OPPDAL 2.0



ALTA 2.0

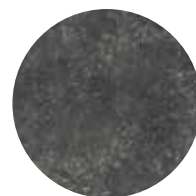

DONKER 2.0

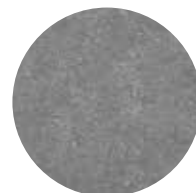

NERAM 2.0



GREIGE 2.0

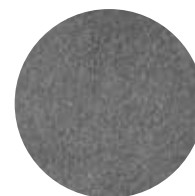

BASALTO 2.0



MULTICOLOR 2.0



floor

60x60
BRUGES 2.0
anticato rett.

wall

30x240
NUT 1.8



colori inalterati nel tempo

colors remains
unchanged
over time

floor

60x60
BRUGES 2.0
anticato rett.

wall

30x240
NUT 1.8





floor
60x60
NAMUR 2.0
anticato rett.





**floor**

20x20 - 20x30

NAMUR 2.0

bordo vintage

60x60

GENT 2.0

anticato rett.



floor

20x20 - 20x30

NAMUR 2.0

bordo vintage

60x60

GENT 2.0

anticato rett.







**floor**

60x120

SILVER WHITE 2.0

pool

60x120

SILVER WHITE 2.0

SILVER BLACK 2.0





floor

60x120

SILVER WHITE 2.0

pool

SILVER BLACK 2.0



floor
60x60
ALTA 2.0





80



floor
60x120
ALTA 2.0

82

elevata resa estetica

high aesthetic



floor

60x60

DONKER 2.0





floor
60x60
GREIGE 2.0



wall
26,5x180
NUT

floor
60x60
MULTICOLOR 2.0

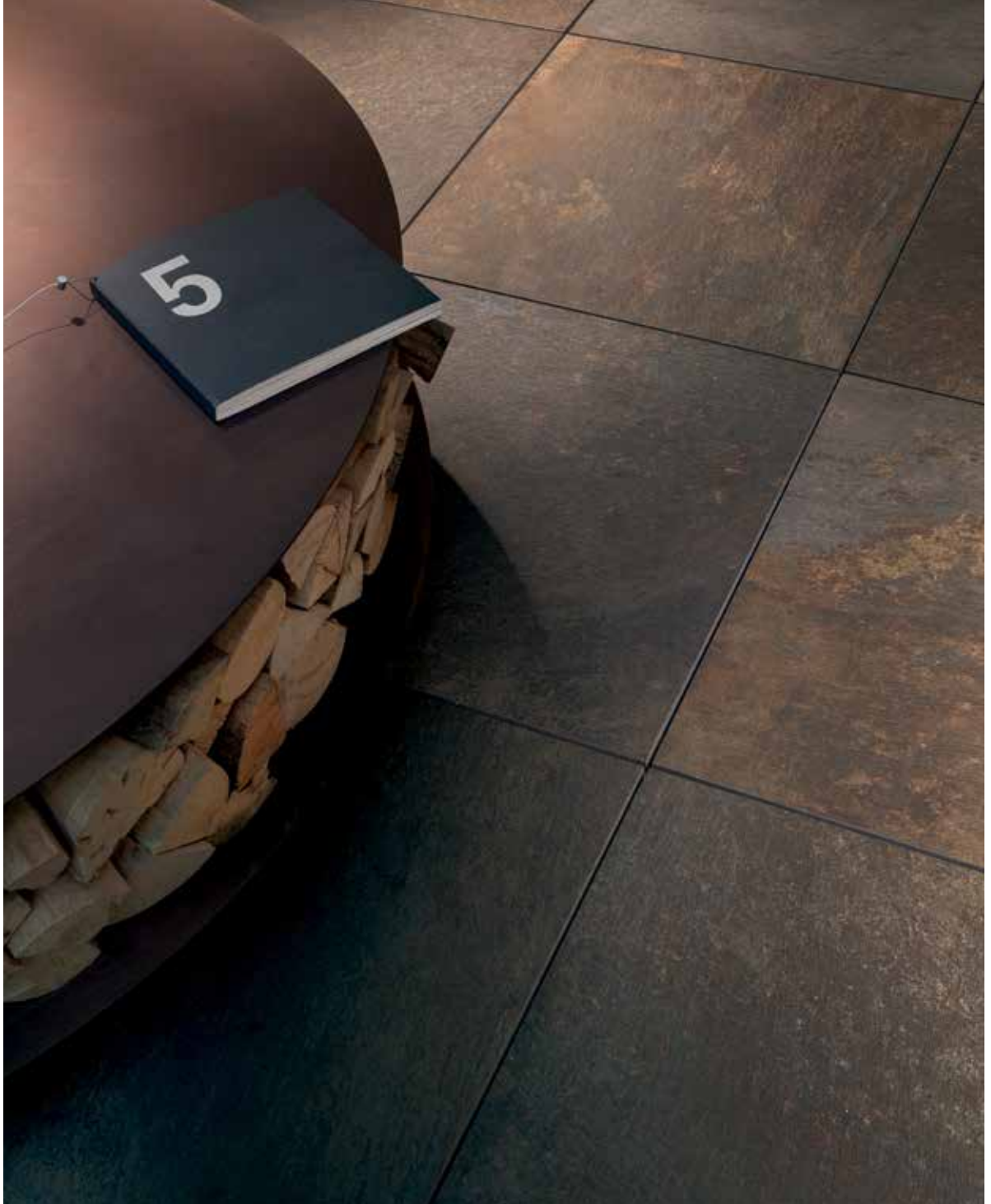





58

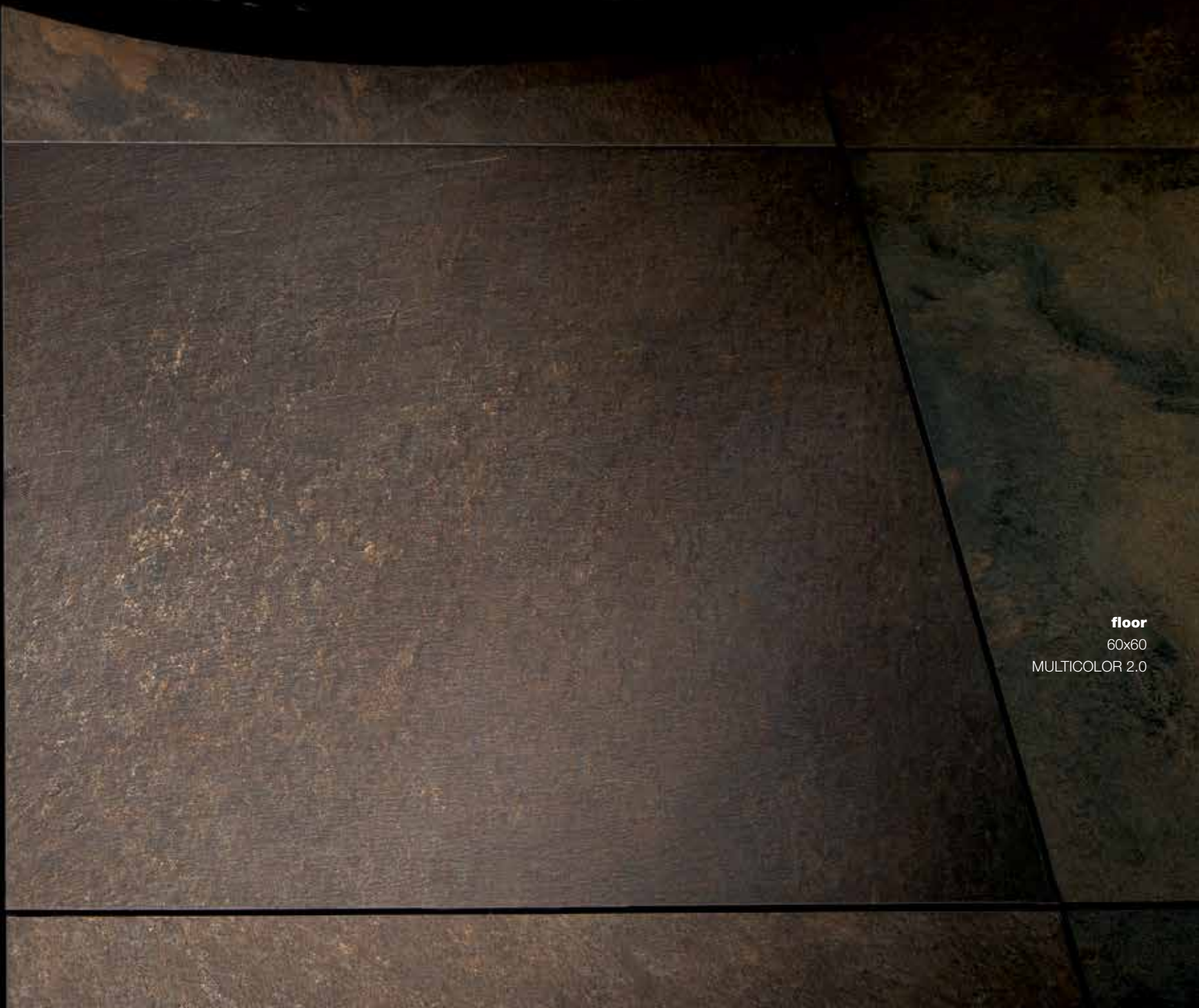

floor
60x60
MULTICOLOR 2.0

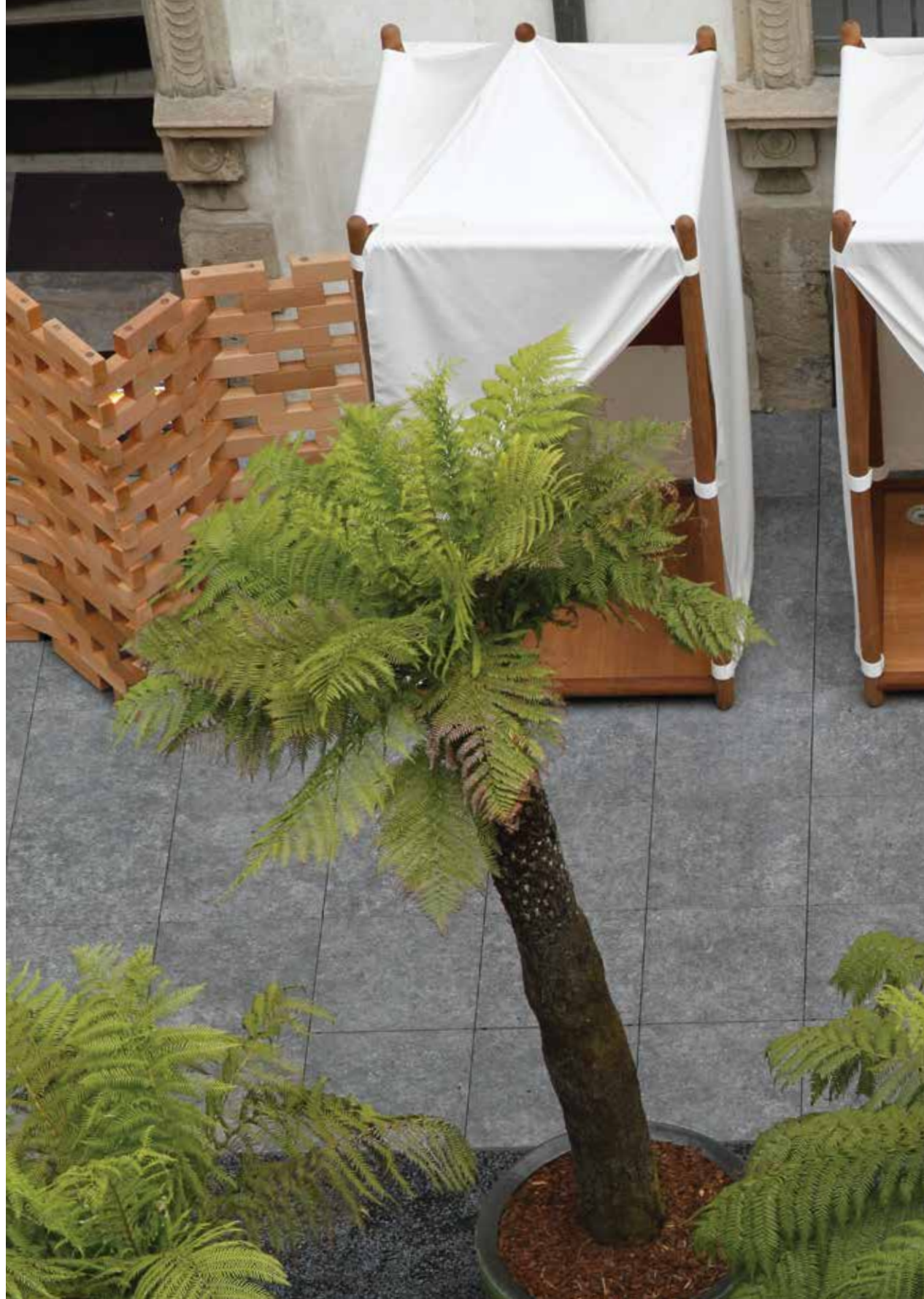

floor
60x60
NERAM 2.0







floor
60x60
BASALTO VINTAGE 2.0

94

resiste ai carichi di rottura

ultimate strength resistance

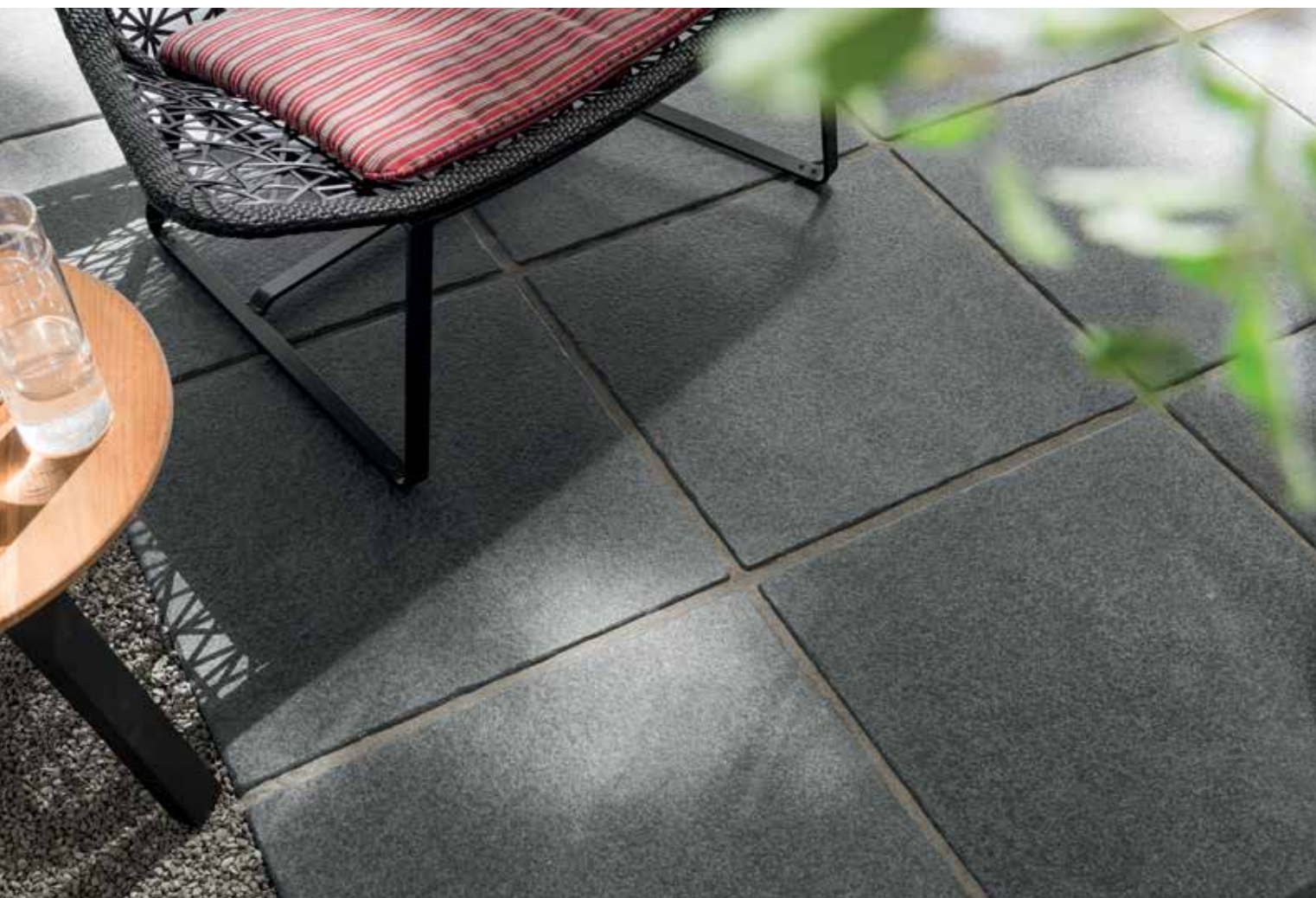



floor
60x60
BASALTO VINTAGE 2.0

SKE2.0

caratteristiche tecniche TECHNICAL CHARACTERISTICS

Economico, leggero, ingelivo, antiscivolo (R11), ignifugo, isolante termico, removibile è il prodotto ideale per esterni residenziali come patio, terrazze, gazebo, piscine, giardini, vialetti, scale, balconi, solai; o commerciali come distese estive di bar e ristoranti, aree esterne di centri benessere, piscine, zone balneari, camminamenti.

SKE Monolitico 2.0 è un'innovativa soluzione realizzata in gres fine porcellanato di spessore 2cm. Consente di creare un piano di calpestio autoportante e senza incollaggi dalle ottime rese estetiche e tecniche, senza lavorazioni aggiuntive, come rinforzi. Rappresenta il prodotto ideale per la sopraelevazione, garantendo traffici medio pesanti (Classe 3).

Affordable, light, frost-proof, anti-slip (R11), flame resistant, heat insulation, removable is ideal both for residential outdoor, such as patio, terraces, gazebos, swimming-pools, gardens, garden paths, stairs, balconies, attics, and for commercial outdoor such as bar and restaurant' dehors, spa's exterior, swimming-pools, beach resorts and walkways.

SKE monolithic 2.0 is an innovative solution made of fine gres porcelain stoneware, 2cm thickness. It creates a free-standing and not glued floor with an excellent aesthetic and technical performances without additional processing, such as reinforcement.

SKE Monolithic 2.0 stands for the ideal product for pedestal set, assuring medium to heavy traffic (Class 3).



CLASSI DI CARICO DI ESERCIZIO $\geq 3 \text{ kN}$
LOAD-BEARING CLASSIFICATION

$\neq 2 \text{ cm}$

perché scegliere 2 centimetri?

WHY CHOOSE 2 CM?



Resistenza agli sbalzi termici.

Thermal shock resistance.



Resistenza al gelo.

Frost resistance.



Resistenza al fuoco.

Fire resistance.

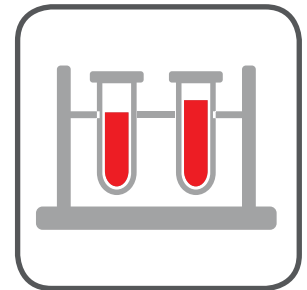

Resistenza alle macchie, acidi e prodotti chimici.

Resistant to stains, acid and chemicals.

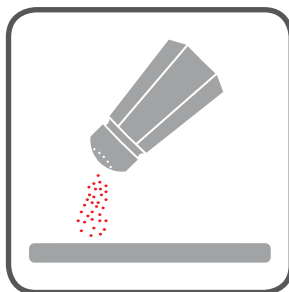

Resistenza alla corrosione del sale.

Resistant to corrosion from salt.



Resistenza alla muffa, muschio e trattamenti verderame.

Resistant to attack from mould, moss and verdigris treatments.

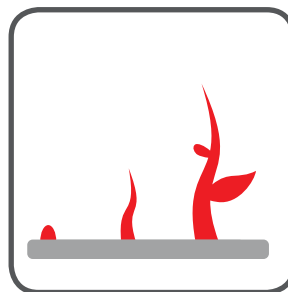

Resistenza alla fioritura e all'insorgere di aloni.

Resistant to florescence and formation of dark halos.

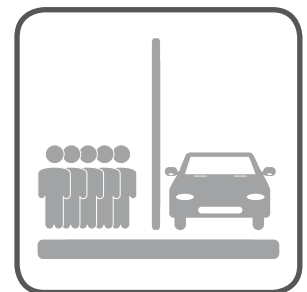

Durevole: resistenza all'alto traffico pedonale e su ruota.

Durable: withstands heavy foot and wheel traffic.



Ipoallergenico. Non rilascia inquinanti.

Hypoallergenic. No VOC.



Facile da sterilizzare.

Easy to sterilize.



Manutenzione ecologica.

Eco-friendly maintenance.



Riciclabile ed ecologico.

Recyclable and ecological.

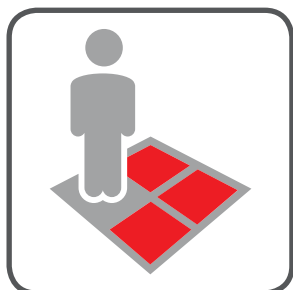

Facile da posare.

Easy to install.

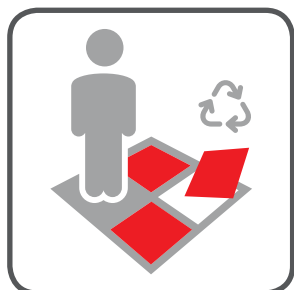

Rimovibile e riutilizzabile.

Removable and reusable.

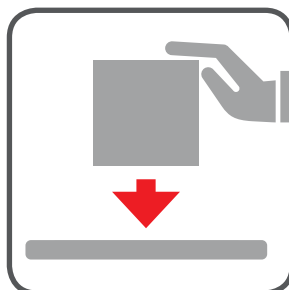

Installazione versatile. Varie possibilità di posa, quali sopraelevata, su erba, e su fondo morbido.

Versatile installation. Various installation methods including pedestal set, grass and gravel.

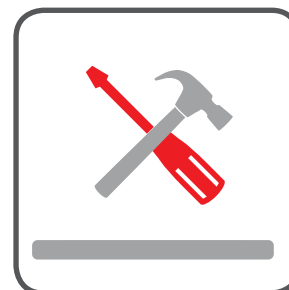

Nessuna manutenzione.

Virtually no maintenance.



Facile da pulire.

Easy to clean.



Resistenza allo scivolamento.

Slip resistance.

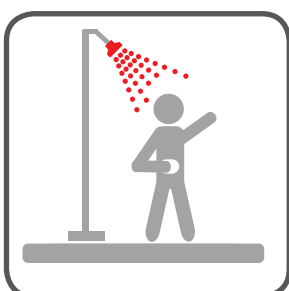

Utilizzo in contesti asciutti, bagnati e sommersi.

Dry, wet, and submerged applications.

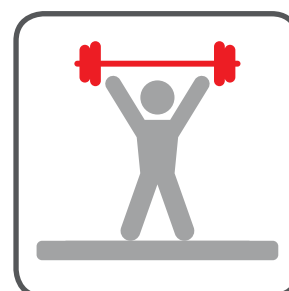

Resistenza ai carichi di rottura.

High breaking load.

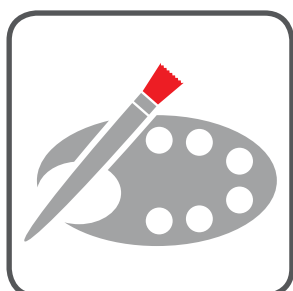

Colori inalterati nel tempo.

Colors remains unchanged over time.



Disponibile in un'ampia gamma di colori/finiture.

Available in a broad range of colors/styles.

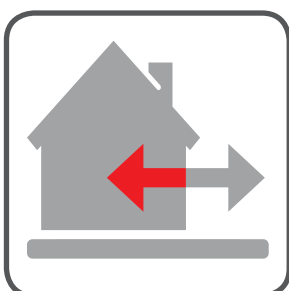

Uso esterno + interni coordinati + pezzi speciali come bordi piscina e scalini.

Outdoor application + coordinated indoors + special pieces such as pool edges and steps.

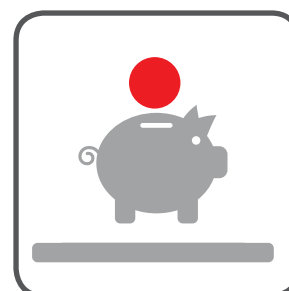

Importante risparmio grazie all'eccezionale ciclo di vita del prodotto.

Exceptional life cycle-cost = best value.

perché scegliere la posa sopraelevata?

WHY CHOOSE RAISED FLOOR?

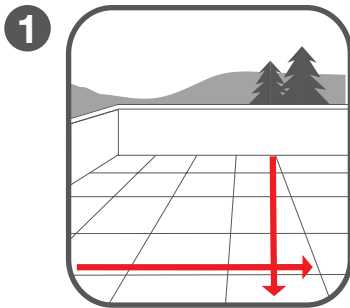

Dal punto di vista estetico, consente di ottenere pavimentazioni continue ad un'unica pendenza, senza corpi di recupero a vista per l'acqua (come griglie o scarichi).

From an aesthetic point of view, it allows for planar and uniform surfaces with no uneven levels or visible water drainage systems (grids or water discharge pipes).

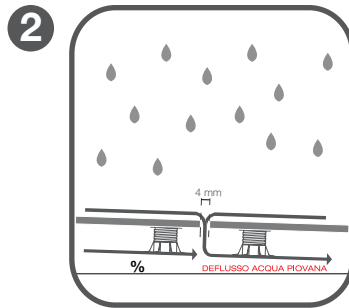

Il leggero spazio tra un pannello e l'altro consente un rapido e adeguato deflusso delle acque in eccesso. Facile da pulire. (Vedi pulizia e manutenzione / consigli di posa a pag. 102.)

The slight gap between gres slabs allows a quick water drainage. Easy to clean. (See cleaning and maintenance / laying instruction at page 102.)

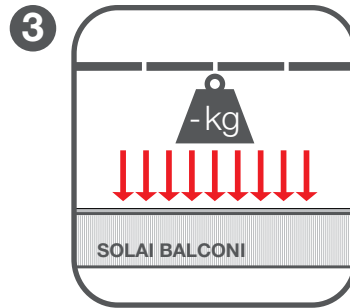

Minor carico su solai e balconi, evitando l'ultimo strato di caldanea e colla.

Less load bearing in attics and on balconies as the last layer of concrete and glue is not necessary.

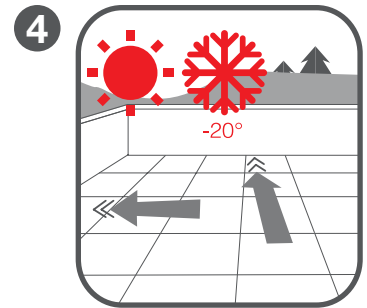

Ingelivo, assorbe le dilatazioni termiche della soletta, causa diretta dei cedimenti delle pavimentazioni esterne posate tradizionalmente.

Frost resistant, it absorbs the thermal expansions of the concrete substrate, the direct cause of traditional external flooring subsidences.

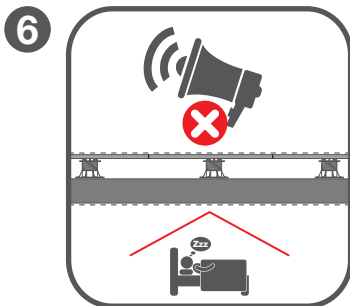

Favorisce l'isolamento acustico.

Best acoustic insulation.

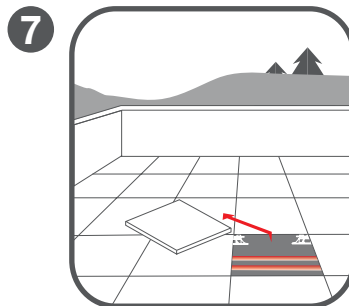

Tubazioni nascoste ma facilmente ispezionabili.

Hiding pipes but easy to inspect.

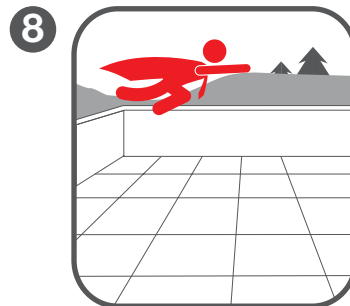

Velocità di posa.

Speed of installation.

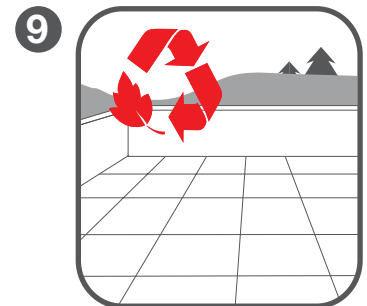

Riciclabile.

Recyclable.

5

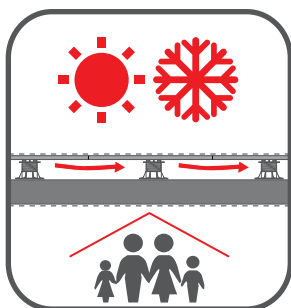

L'intercapedine tra pavimento e soletta favorisce il miglior isolamento termico.

The gap between the floor and the concrete substrate fosters thermal insulation.

10

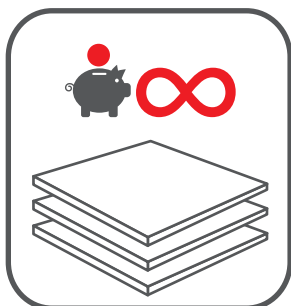

Garanzia di costi inferiori di posa e manutenzione, durata sostanzialmente eterna.

Value for money solution in terms of laying and maintenance, durable over time.

floor
60x60
GREIGE 2.0



102

dedicato all'OUTDOOR dedicated to the OUTDOOR



GECO®

SISTEMA BREVETTATO / PATENTED SYSTEM

OUTDOOR Revolution

FACCIAE IN GRES A SORMONTO

OVERLAP FACADES MADE IN GRES PORCELAIN

GECO® È UN SISTEMA DI RIVESTIMENTO DELLE PARETI ESTREMAMENTE INNOVATIVO CHE SI ISPIRA ALLE SCANDOLE LIGNEE, DALLE QUALI MUTUA LE VALENZE ESTETICHE CARATTERIZZANDO PERÒ CON LA FORZA ESPRESSIVA E TECNICA DEL GRES PORCELLANATO.

MODULI FORMATI DA TRE LASTRE A SORMONTO INCOLLATE AD UN SUPPORTO IN ALLUMINIO GARANTISCONO UNA DISTANZA DALLA PARETE DI 4 CM, CARATTERISTICA CHE PERMETTE DI ANNOVERARE GECO® NELLA CATEGORIA FACCIAE VENTILATE.

LE PROPRIETÀ INTRINSECHE DI QUESTO SISTEMA BREVETTATO ASSICURANO L'INDIPENDENZA DELLO STESSO DALLE SOLLECITAZIONI PROPRIE DELLA PARETE ESISTENTE. PUÒ ESSERE MONTATO DIRETTAMENTE SU FACCIAE IN LATERIZIO O CEMENTO OPPURE SU SOTTOSTRUTTURE IN ALLUMINIO O IN LEGNO PIALLATO FINO A 22MT DI ALTEZZA.

GECO® IS AN EXTREMELY INNOVATIVE COATING SYSTEM OF WALLS INSPIRED BY WOODEN SHINGLES, FROM WHICH TAKES AESTHETIC VALUE BUT KEEPS THE EXPRESSIVE AND TECHNICAL POWER OF GRES PORCELAIN. MODULES MADE BY THREE ON TOP SLABS PASTED ON AN ALUMINUM SUPPORT GUARANTEE A DISTANCE OF 4CM FROM THE EXISTING WALL, FEATURE ABLE TO INCLUDE GECO INSIDE OF VENTILATED FACADES CATEGORY.

THE INTRINSIC CHARACTERISTICS OF THIS PATENTED SYSTEM ASSURE THE INDEPENDENCE OF ITSELF FROM THE STRESS OF EXISTING WALL. GECO® CAN BE INSTALLED DIRECTLY ON BRICK OR CONCRETE FACADES BUT ALSO ON ALUMINUM OR WOOD SUBSTRUCTURE UP TO 22MT HIGH.

104

wall

29x120

OAK GECO

floor

40x120

OAK DOGA 2.0





GECO®

FACCIAE IN GRES A SORMONTO
OVERLAP FACADES MADE IN GRES PORCELAIN

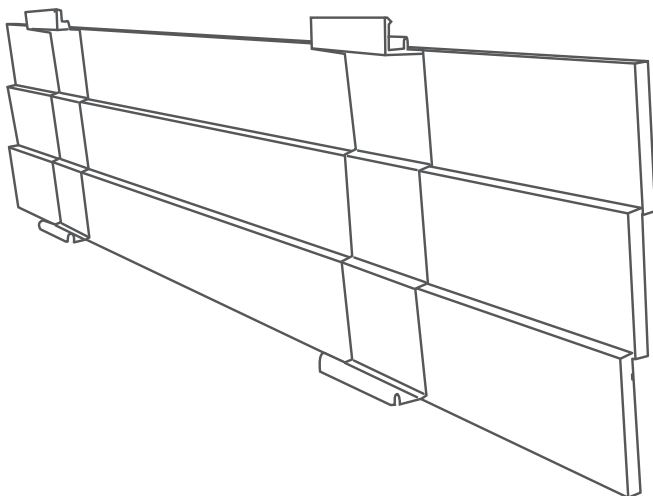
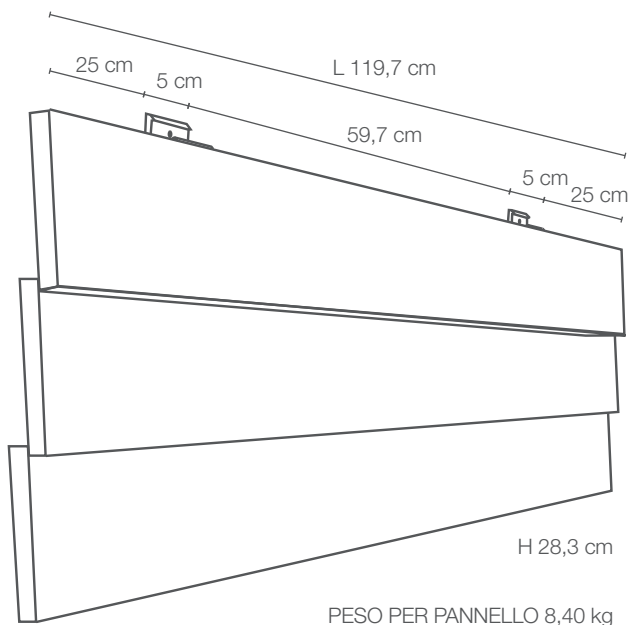

ideale per progetti di riqualificazioni esterne. IDEAL FOR EXTERIOR RENOVATION PROJECTS.

Nella ricerca degli adatti rivestimenti per involucro edilizio il progettista e l'utilizzatore finale sono alla ricerca di un prodotto bello e affidabile, che dia garanzie tecniche ed estetiche nel tempo e che si adatti ad essere installato su tutte le tipologie di facciata, in muratura, in cemento armato, in legno o cappotto termico.

La Lastra in Gres Porcellanato corrisponde a queste necessità. Si tratta di un materiale industriale costantemente controllato e prodotto secondo le più rigide Norme EN 14411 che lo definiscono resistente ed inalterabile nel tempo. È rispettoso dell'ambiente perché frutto di materiali di riciclo produttivo ed al tempo stesso facilmente riciclabile (non contiene plastiche o vernici). Queste caratteristiche lo rendono il materiale principe per essere utilizzato come involucro edilizio. È bello, resistente, facile da installare, economico, in quanto non necessita di costi di manutenzione e permette di risparmiare ed economizzare le spese energetiche dell'edificio.

Searching suitable coatings for building envelope, designers and end-users are looking for a beautiful and reliable product, which is able to give technical and aesthetic guarantee over time and to be installed on all types of facades, made of masonry, reinforce concrete, wooden or thermal coat. The gres porcelain slab matches to these needs. It is an industrial material constantly controlled and produced according to the strictest standards en 14411, which define it resistant and timeless. It is environmentally-friendly because gres porcelain derives from recycle production materials and, at the same time, it is easily recyclable (it not contains plastic or paints). These features make it the main material to be used as a building envelope. It is appealingly beautiful, durable, easy to install, low-cost, since it does not need maintenance costs and it allows to save edifice's energy costs.

come funziona

HOW IT WORKS

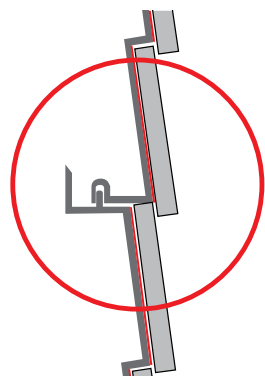

MODULO GECCO® A 3 LASTRE INCOLLATE AD UN SUPPORTO DI ALLUMINIO
GECCO® MODULE WITH 3 SLABS TAPED ON ALUMINIUM SUPPORT.

SORMONTO ON TOP

NB: SI CONSIGLIA IN FASE DI POSA DI MONTARE I PANNELLI LONGITUDINALMENTE CON UNA FUGA DA 3 mm A 5 mm
 NOTE: KRONOS SUGGESTS TO LAY THE PANELS IN A LONGITUDINAL WAY WITH A JOINT FROM 3mm TO 5mm

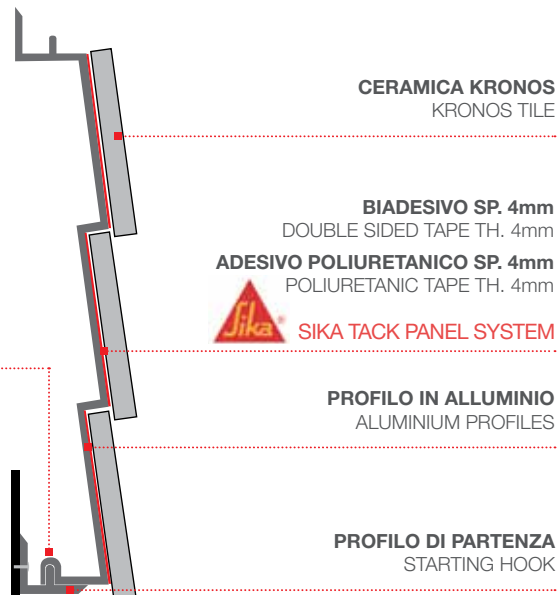

CERAMICA KRONOS
KRONOS TILE

BIADESIVO SP. 4mm
DOUBLE SIDED TAPE TH. 4mm

ADESIVO POLIURETANICO SP. 4mm
POLIURETANIC TAPE TH. 4mm



SIKA TACK PANEL SYSTEM

PROFILO IN ALLUMINIO
ALUMINIUM PROFILES

PROFILO DI PARTENZA
STARTING HOOK

perché scegliere GECCO®?

WHY CHOOSE GECCO®?

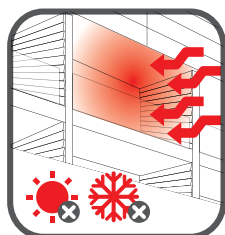

Eliminazione dei ponti termici.
 Elimination of thermal bridges.

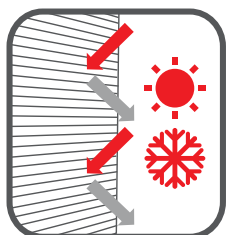

Isolamento termico (Caldo/Freddo).
 Thermal insulation (Hot/Cold).



Isolamento acustico.
 Acoustic insulation.

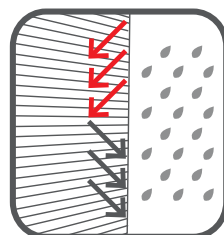

Protezione dall'acqua.
 Protection from water penetration.



Protezione anti-incendio (se installato direttamente su parete in laterizio o su una sottostruttura in alluminio).
 Fire Protection system (if installed directly on a wall in brick or aluminum substructure).



Difficilmente infiammabile C, S2, D0, in conformità alla norma EN13501-1.
 Reaches the fire protection class "Flame-Retardant" C, S2, D0 in accordance with standard EN13501-1 (ex DIN 4102 B1).

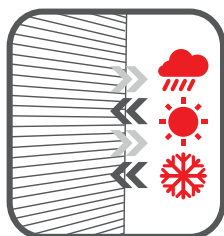

Resistenza agli agenti atmosferici e all'invecchiamento (-40° / +90°).
 Resistance to weathering and aging (-40 ° to + 90 °).

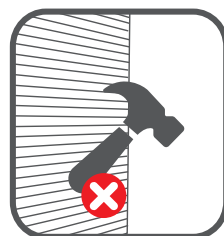

Nessuna manutenzione.
 No maintenance.

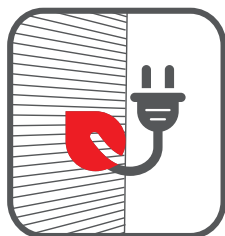

Minori consumi energetici.
 Lower energy needs.



Non rilascia inquinanti.
 NO VOC.



Fissaggio invisibile fino a 22 m di altezza.
 Invisible fixing up to 22 m height.



Inalterabile nel tempo.
 Unalterable during time.

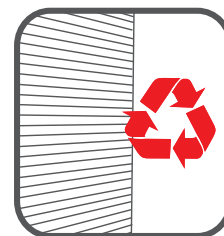

Riciclabile.
 Recyclable.

i contesti ideali che valorizzano le applicazioni GECO®

THE IDEAL CONTEXTS THAT ENHANCE GECO® APPLICATIONS.



**CONTESTI BALNEARI
E LACUSTRI**
(umidità, salsedine).

SEA AND LAKE AREAS
(humidity, dried salt).



CONTESTI MONTANI
(gelo, sbalzi termici).

MOUNTAIN AREAS
(freeze, thermal leap).



**CONTESTI DI EDILIZIA CIVILE
E INDUSTRIALI**
(ristrutturazioni).

CIVIL CONSTRUCTIONS AND
INDUSTRIAL AREAS (renovations).

FACCIAE ESTERNE
EXTERNAL WALLS

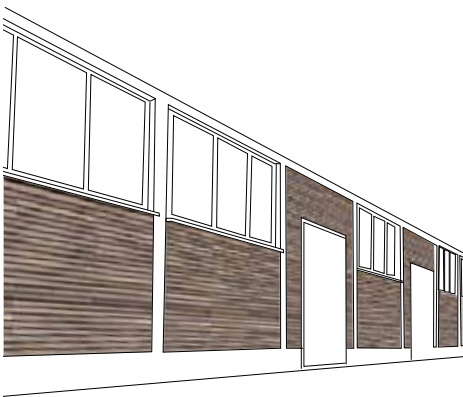

DIVISORI BALCONI
TERRACES DIVIDING WALLS

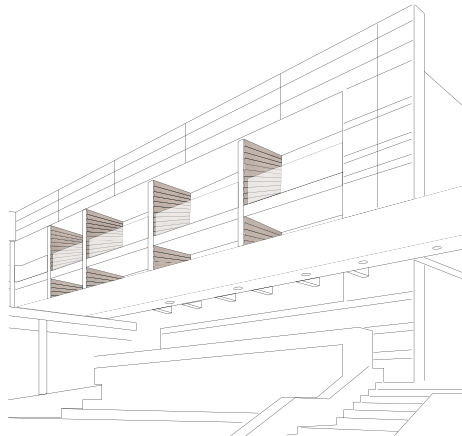

CANCELLATE E PORTONI
FENCES AND GATES

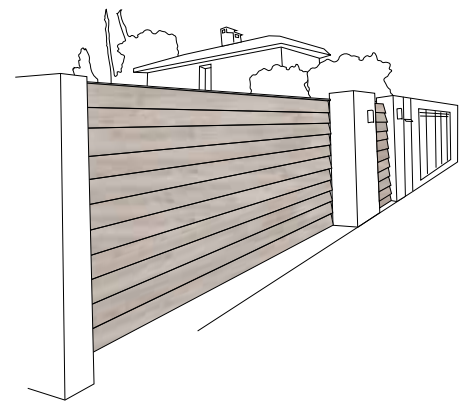

totalmente personalizzabile con i prodotti Kronos

TOTALLY CUSTOMIZE WITH KRONOS PRODUCTS.



WOOD
FINITURA **LEGNO**



STONE
FINITURA **PIETRA**



CONCRETE
FINITURA **CEMENTO**



110

**progetti
personalizzati,
ambiente coordinato**

**PERSONALISED PROJECTS,
CO-ORDINATED SPACES**

pezzi speciali a completamento

SPECIAL PIECES TO COMPLETE THE SERIES

111

Kronos Tecnica propone una selezione ricca e completa di elementi di finitura per esterno come bordi piscina, gradini, scalini ed elementi a L.

Tutti gli elementi, realizzati in gres fine porcellanato, sono completamente personalizzabili in base alle esigenze del progetto. Questo consente a designer, progettisti o arredatori di avere una visione dello spazio globale, e permette di creare ambienti perfettamente coordinati con la pavimentazione.

Kronos Tecnica offers a complete range of outdoor special pieces such as swimming-pool edges, steps and "L-shaped" elements.

All these elements are in porcelain stoneware and can be personalised and tailored according to project needs. *This allows designers and planners to have a global vision of the space and to create co-ordinated projects.*

scalini

STEPS



ELEMENTO A ELLE
ELLE ELEMENT

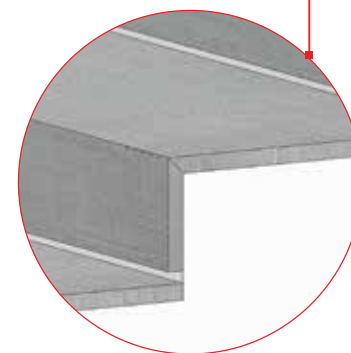
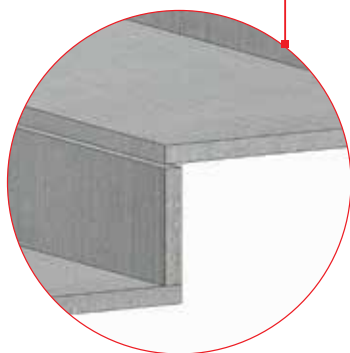
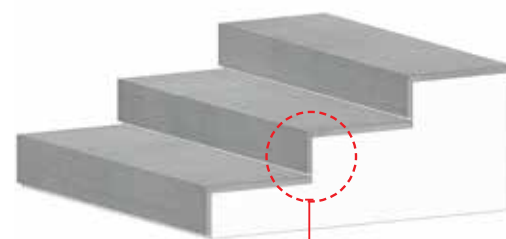
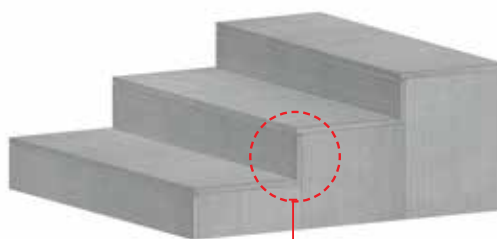
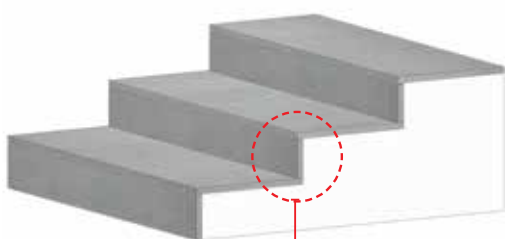
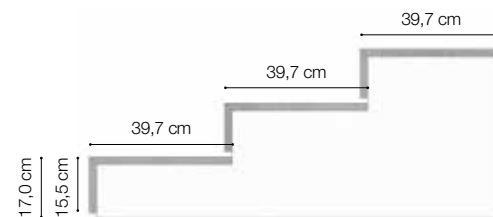
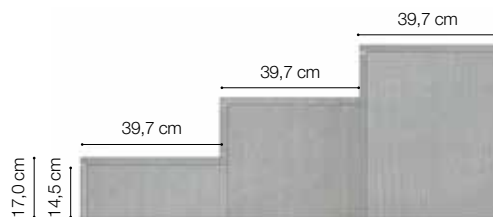
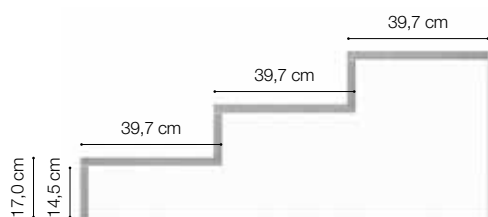

112 bordi piscina POOL EDGES SYSTEM

 SPESSORE
THICKNESS
10 mm



01 SFIORO ESTERNO - FINLANDESE EXTERNAL EDGE - FINNISH OVERFLOW

SFIORO ESTERNO 1
EXTERNAL EDGE 1

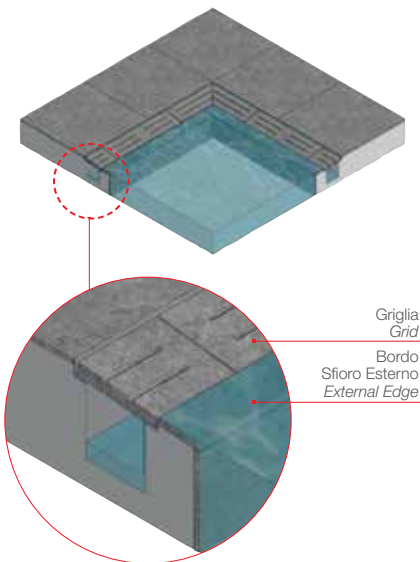

SFIORO ESTERNO 2
EXTERNAL EDGE 2

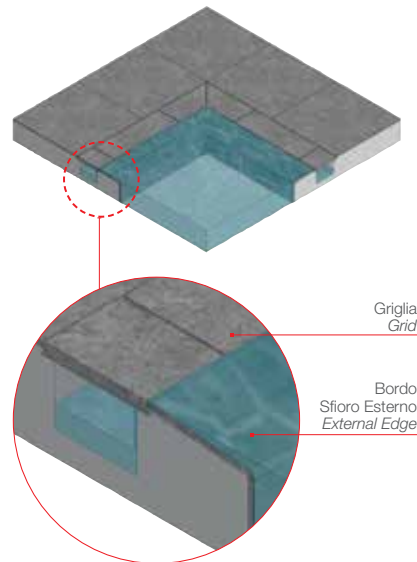

02 SFIORO ESTERNO
EXTERNAL EDGE - ELEVATED WATER LEVEL

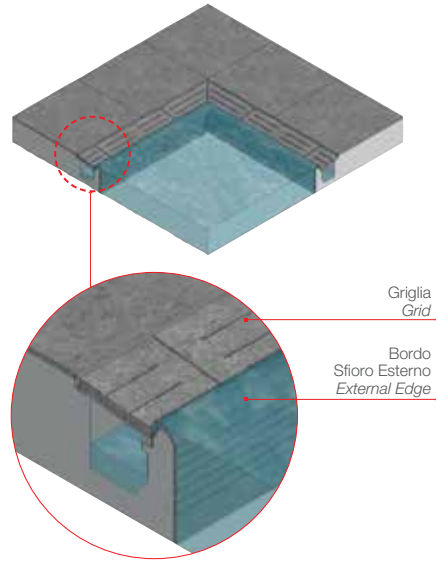
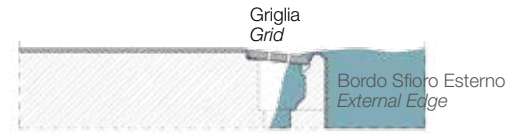

BORDO A CASCATA
OVERFLOW WATER FALL

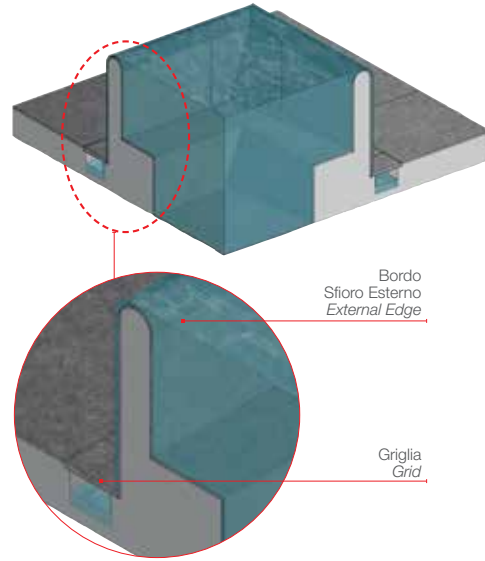
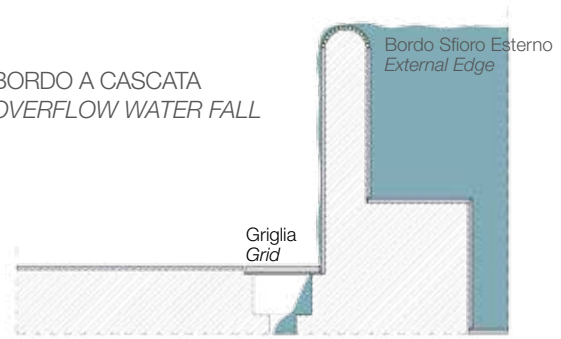

03 SFIORO INTERNO PERIMETRALE
INTERNAL PERIMETRAL EDGE (WIESBADEN SYSTEM)

SFIORO INTERNO 1
DECREASED WATER LEVEL 1

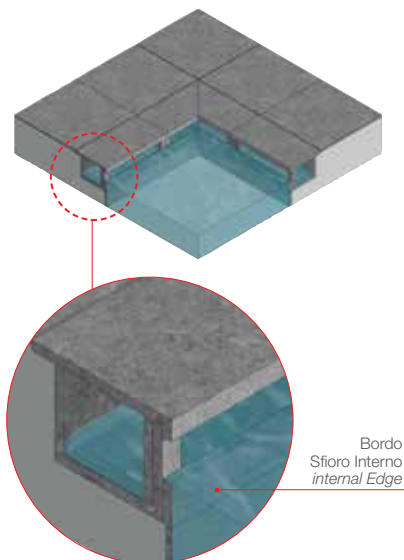

SFIORO INTERNO 2
DECREASED WATER LEVEL 2

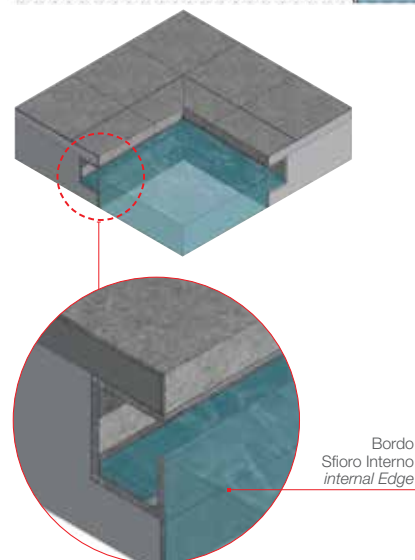
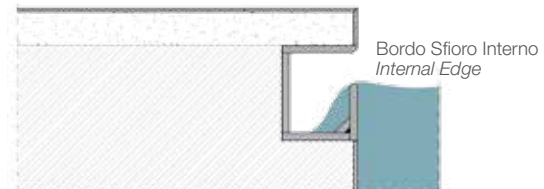

114 bordi piscina POOL EDGES SYSTEM

 **SPESSORE
THICKNESS**
10 mm



SFIORO INTERNO 2 CON BORDO A TORO
DECREASED WATER LEVEL 2 BULLNOSE EDGE

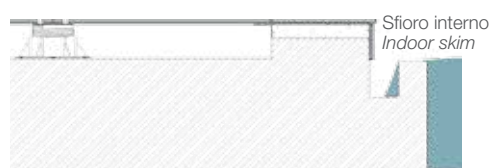

SFIORO INTERNO 3 CON BORDO A COSTA RETTA
DECREASED WATER LEVEL 3 COSTA RETTA EDGE

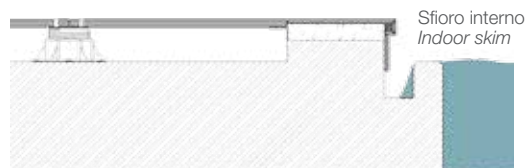

SFIORO INTERNO 4 A BECCO DI CIVETTA
DECREASED WATER LEVEL 4 QUARTER ROUND EDGE

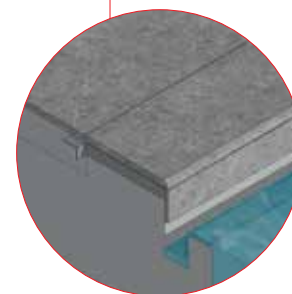
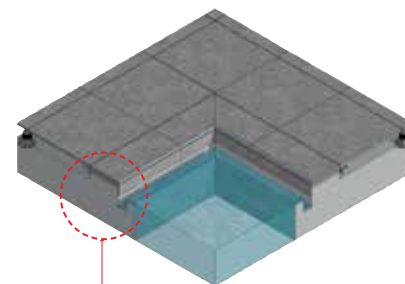
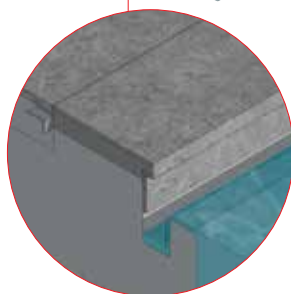
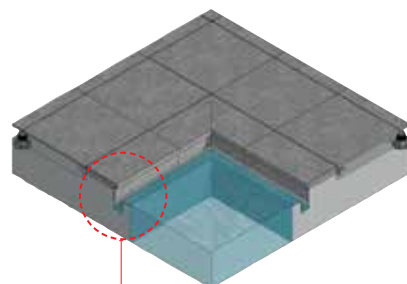
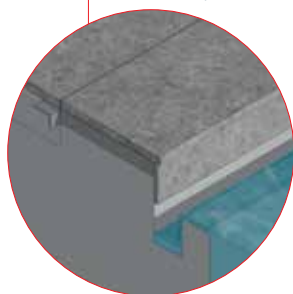
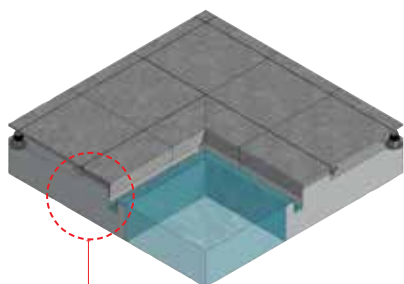
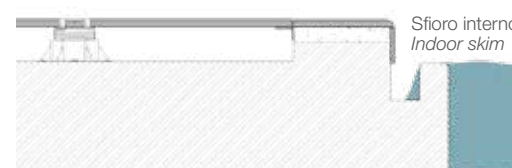

04 SFIORO INTERNO - SKIMMER

INTERNAL EDGE - SKIMMER

SKIMMER 1A CON BORDO A TORO
SKIMMER 1A BULLNOSE EDGE

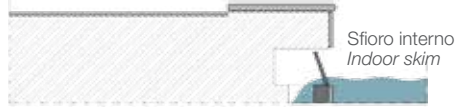

SKIMMER 1B CON BORDO A DOPPIO TORO
SKIMMER 1B DOUBLESIDES BULLNOSE EDGE



SKIMMER 2 CON BORDO LISTELLATO
SKIMMER 2 LISTELLATO EDGE

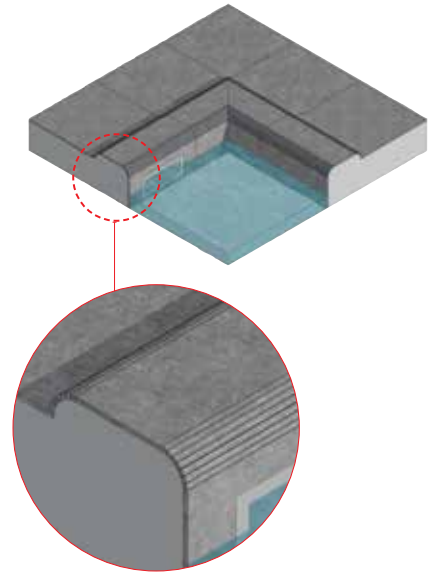
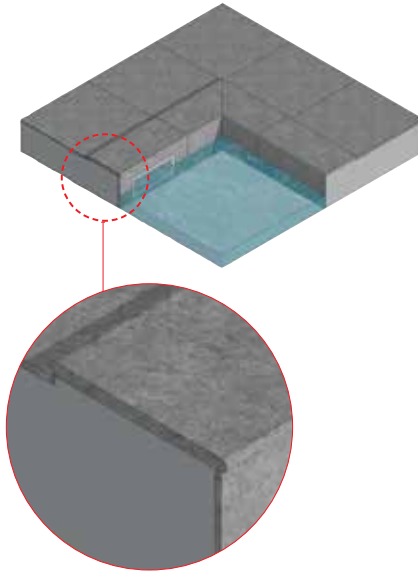
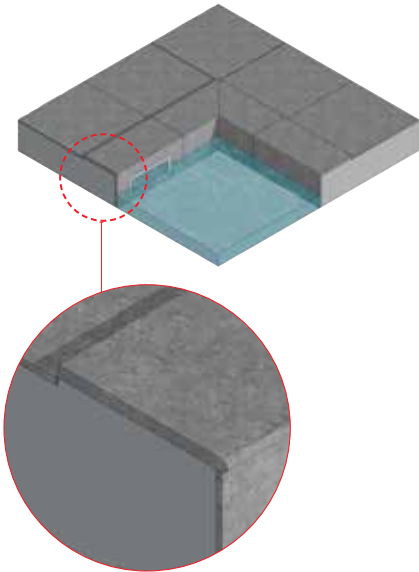

SKIMMER 3 CON BORDO A ONDA BASSA
SKIMMER 3 LOW WAVE EDGE

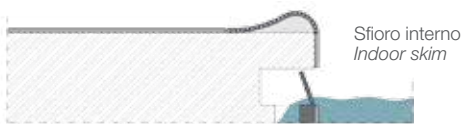

SKIMMER 4 CON BORDO A ONDA ALTA
SKIMMER 4 HIGH WAVE EDGE



SKIMMER 5 CON BORDO A ELLE
SKIMMER 5 ELLE EDGE

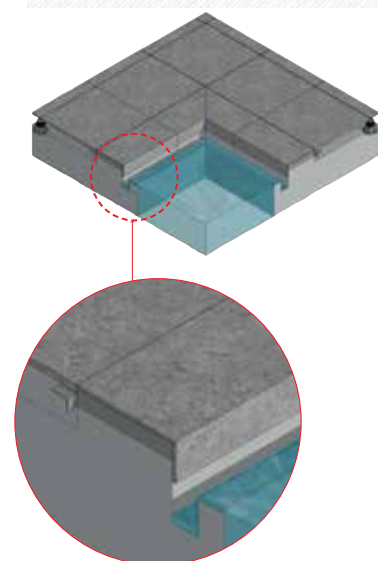
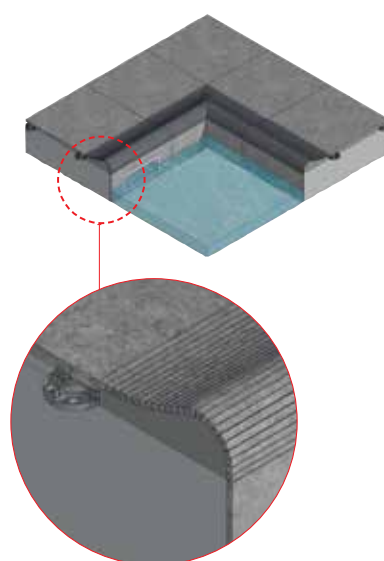
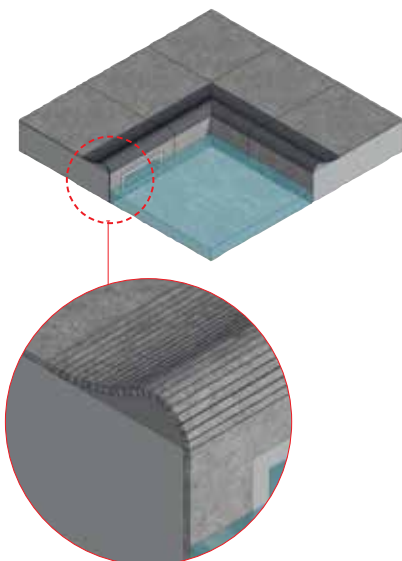
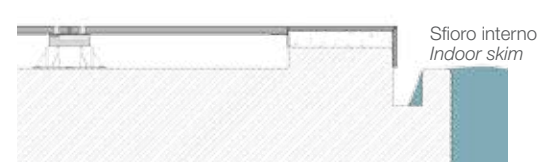

CONCRETE

FINITURA CEMENTO

SKE2.0



PRIMA MATERIA



60x60 CEMENTO 2.0
8062 | rett. | ■ K0690



60x60 SANDALO 2.0
8064 | rett. | ■ K0690



60x60 GENERE 2.0
8063 | rett. | ■ K0690



20x120 CEMENTO 2.0
8090 | rett. | ■ K0850

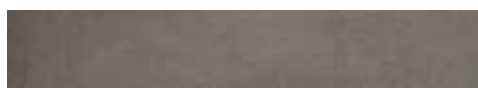

20x120 SANDALO 2.0
8093 | rett. | ■ K0850



20x120 CENERE 2.0
8091 | rett. | ■ K0850



40x120 CEMENTO 2.0
8095 | rett. | ■ K0790

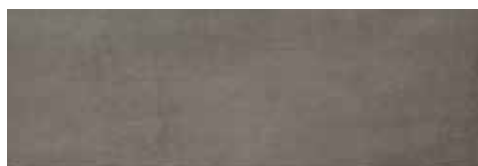

40x120 SANDALO 2.0
8098 | rett. | ■ K0790



40x120 CENERE 2.0
8096 | rett. | ■ K0790

PEZZI SPECIALI SPECIAL PIECES Disponibili in tutti i colori Available in all colors



60x60 h10 ■ K0746
CHIUSURA



40x120 h10 ■ K1080
CHIUSURA A



40x120 h10 ■ K1210
ANGOLO CHIUSURA A



30x60 TORO ■ K0755
40x120 TORO ■ K1055



60x60 h10 ■ K1006
ANGOLO CHIUSURA



40x120 h10 ■ K0788
CHIUSURA B



40x120 h10 ■ K1210
ANGOLO CHIUSURA B



30x60 DOPPIO TORO ■ K1098
40x120 DOPPIO TORO ■ K1210

PERSONALIZZAZIONE

Data l'eterogeneità delle situazioni di applicazioni di SKE, la nostra azienda offre la possibilità di realizzare pezzi speciali completamente personalizzati in base alle esigenze contestuali e ambientali.

CUSTOMIZATION

Due to the heterogeneity of the situations for the SKE applications, our company offers the possibility to create special pieces completely customized to the needs and context environment.

WOOD

FINITURA LEGNO

SKE2.0

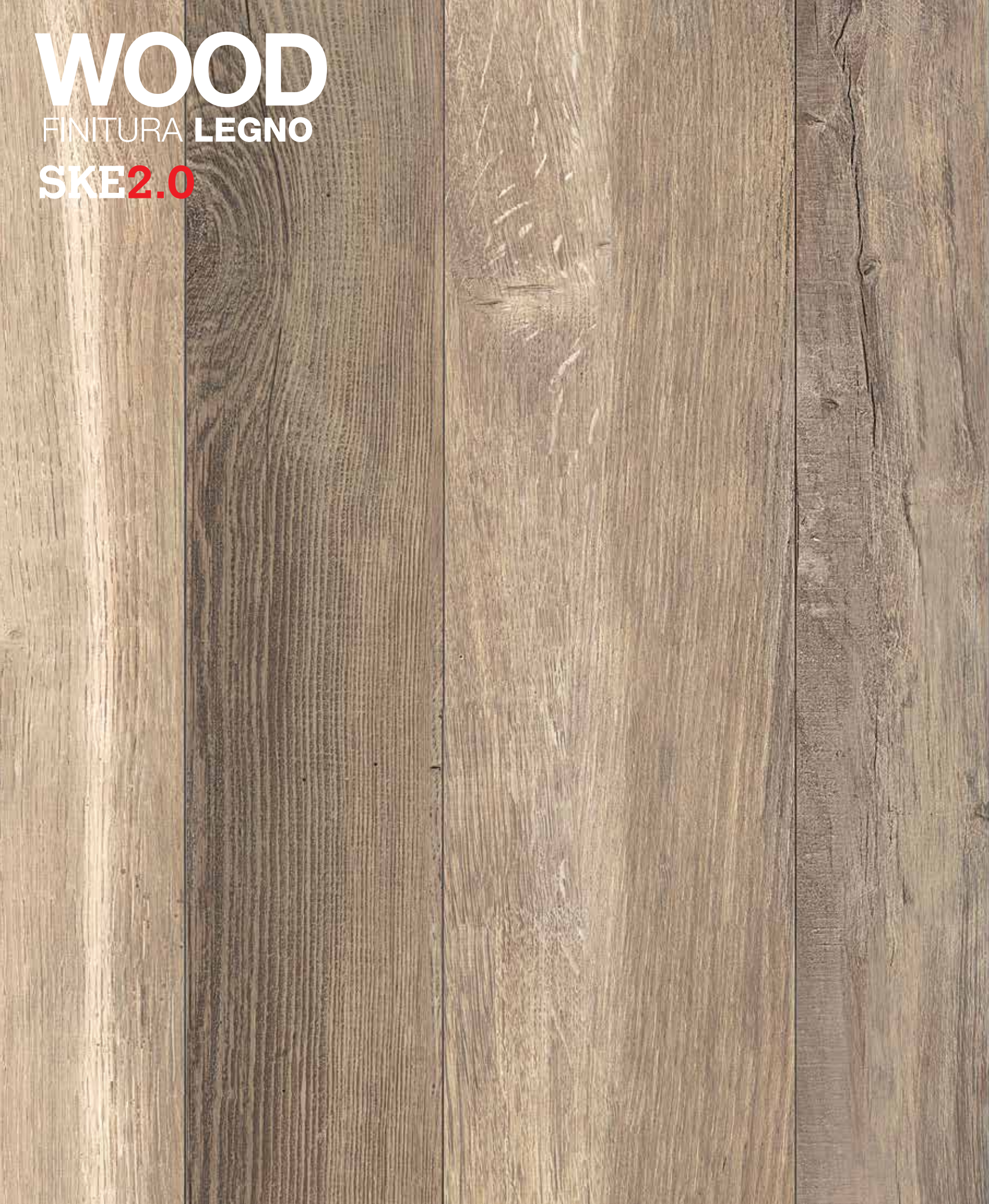

WOOD SIDE



60x60 KAURI DOGA 2.0
6547 | rett. | ■ K0705



20x120 KAURI 2.0
6682 | rett. | ■ K0882



40x120 KAURI DOGA 2.0
6652 | rett. | ■ K0805



60x60 NUT DOGA 2.0
6548 | rett. | ■ K0705



20x120 NUT 2.0
6683 | rett. | ■ K0882



40x120 NUT DOGA 2.0
6653 | rett. | ■ K0805



60x60 MAPLE DOGA 2.0
6545 | rett. | ■ K0705



20x120 MAPLE 2.0
6680 | rett. | ■ K0882



40x120 MAPLE DOGA 2.0
6650 | rett. | ■ K0805



60x60 OAK DOGA 2.0
6546 | rett. | ■ K0705



20x120 OAK 2.0
6681 | rett. | ■ K0882



40x120 OAK DOGA 2.0
6651 | rett. | ■ K0805

TEKNOWOOD



60x60 EBANO 2.0 struttura exter
3463 | rett. | ■ K0705



60x60 FAGGIO 2.0 struttura exter
3468 | rett. | ■ K0705



60x60 ROVERE 2.0 struttura exter
3464 | rett. | ■ K0705

PERSONALIZZAZIONE

Data l'eterogeneità delle situazioni di applicazione di SKE, la nostra azienda offre la possibilità di realizzare pezzi speciali completamente personalizzati in base alle esigenze contestuali e ambientali.

CUSTOMIZATION

Due to the heterogeneity of the situations for the SKE applications, our company offers the possibility to create special pieces completely customized to the needs and context environment.

PEZZI SPECIALI SPECIAL PIECES Disponibili in tutti i colori Available in all colors



60x60 h10 ■ K0780
CHIUSURA A



60x60 h10 ■ K1005
ANGOLO CHIUSURA A



40x120 h10 ■ K1075
CHIUSURA A



40x120 h10 ■ K1149
ANGOLO CHIUSURA A



30x60 TORO ■ K0780
40x120 TORO ■ K1055



60x60 h10 ■ K0780
CHIUSURA B



60x60 h10 ■ K1005
ANGOLO CHIUSURA B



40x120 h10 ■ K0790
CHIUSURA B



40x120 h10 ■ K1149
ANGOLO CHIUSURA B



30x60 DOPPIO TORO ■ K1005
40x120 DOPPIO TORO ■ K1246

WOOD

FINITURA LEGNO

 **18 mm**

DECK WAY



30x240 OAK 1.8

6691 | rett. | ■ K1145



30x240 NUT 1.8

6692 | rett. | ■ K1145



30x240 MAPLE 1.8

6690 | rett. | ■ K1145

30x240

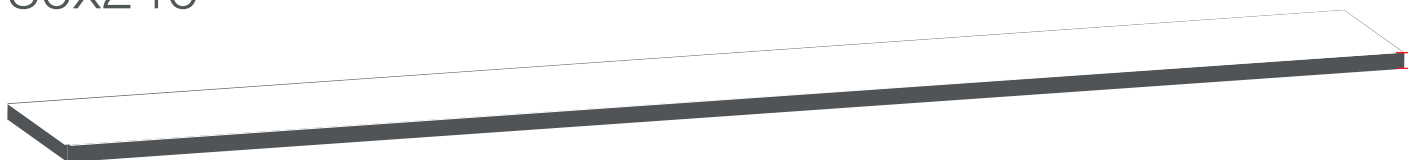

spessore
THICKNESS

18 mm

STONE

FINITURA PIETRA

SKE2.0



ROCKS



60x60 SILVER WHITE 2.0
7360 | rett. | ■ K0730



60x120 SILVER WHITE 2.0
7365 | rett. | ■ K0805



60x60 SILVER BLACK 2.0
7361 | rett. | ■ K0730



60x120 SILVER BLACK 2.0
7366 | rett. | ■ K0805



60x60 GOLD 2.0
7363 | rett. | ■ K0730



60x120 GOLD 2.0
7368 | rett. | ■ K0805



60x60 ALTA 2.0
6044 | rett. | ■ K0730



60x120 ALTA 2.0
6045 | rett. | ■ K0805



60x60 SILVER GREY 2.0
7364 | rett. | ■ K0730



60x60 OPPDAL 2.0
6474 | rett. | ■ K0730

CARRIERE DU KRONOS



60x60 NAMUR 2.0
8355 | ant. rett. | ■ K0730

BORDO/EDGE VINTAGE



20x20 NAMUR 2.0
9490 | ■ K0990



20x30 NAMUR 2.0
9495 | ■ K0990



60x60 GENT 2.0
8356 | ant. rett. | ■ K0730

BORDO/EDGE VINTAGE



20x20 GENT 2.0
9491 | ■ K0990



20x30 GENT 2.0
9496 | ■ K0990



60x60 BRUGES 2.0
8356 | ant. rett. | ■ K0730

BORDO/EDGE VINTAGE



20x20 BRUGES 2.0
9492 | ■ K0990



20x30 BRUGES 2.0
9497 | ■ K0990

STONE

FINITURA PIETRA

SKE2.0



60x60 DONKER 2.0
6043 | rett. | ■ K0730



60x120 DONKER 2.0
6027 | rett. | ■ K0805



60x60 BASALTO 2.0
6023 | rett. | ■ K0730



60x60 NERAM 2.0
6042 | rett. | ■ K0730



60x120 NERAM 2.0
6026 | rett. | ■ K0805



60x60 MULTICOLOR 2.0
6024 | rett. | ■ K0730



60x60 GREIGE 2.0
6041 | rett. | ■ K0730

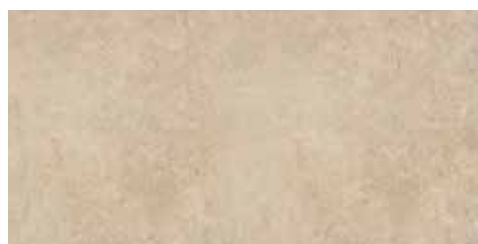

60x120 GREIGE 2.0
6025 | rett. | ■ K0805

PEZZI SPECIALI SPECIAL PIECES **Disponibili in tutti i colori** Available in all colors



60x60 h10 ■ K0975
CHIUSURA



60x120 h10 ■ K1140
CHIUSURA A



60x120 h10 ■ K1246
ANGOLO CHIUSURA A



30x60 TORO ■ K0805
30x120 TORO ■ K1105



60x60 h10 ■ K1006
ANGOLO CHIUSURA



60x120 h10 ■ K1000
CHIUSURA B



60x120 h10 ■ K1246
ANGOLO CHIUSURA A



30x60 DOPPIO TORO ■ K1050
30x120 DOPPIO TORO ■ K1280

PERSONALIZZAZIONE

Data l'eterogeneità delle situazioni di applicazione di SKE, la nostra azienda offre la possibilità di realizzare pezzi speciali completamente personalizzati in base alle esigenze contestuali e ambientali.

CUSTOMIZATION

Due to the heterogeneity of the situations for the SKE applications, our company offers the possibility to create special pieces completely customized to the needs and context environment.

126

BORDO / EDGE

VINTAGE

SKE2.0

Vintage è un metodo di lavorazione manuale che permette di ottenere tutti i lati diversi e crea l'emozione del prodotto anticato e "vissuto".

Vintage is a method of manual workmanship which makes all sides of the tile different to each other, giving the emotion of an old-fashioned product.



60x60

60x120

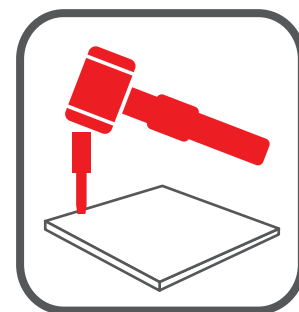

Lavorazione manuale del bordo.
Edge handwork.

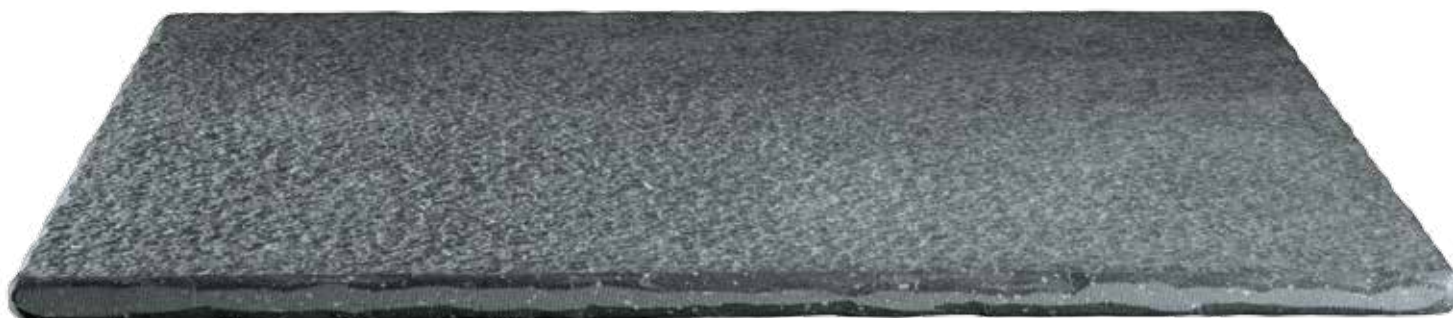

È possibile personalizzare con il bordo vintage anche altri prodotti Kronos SKE2.0, con finitura legno o cemento, tuttavia l'effetto migliore si ha con la finitura pietra.
It is possible to customize the vintage edge also for other SKE2.0 styles, such as wood or concrete. However the best result is obtained with stone style.

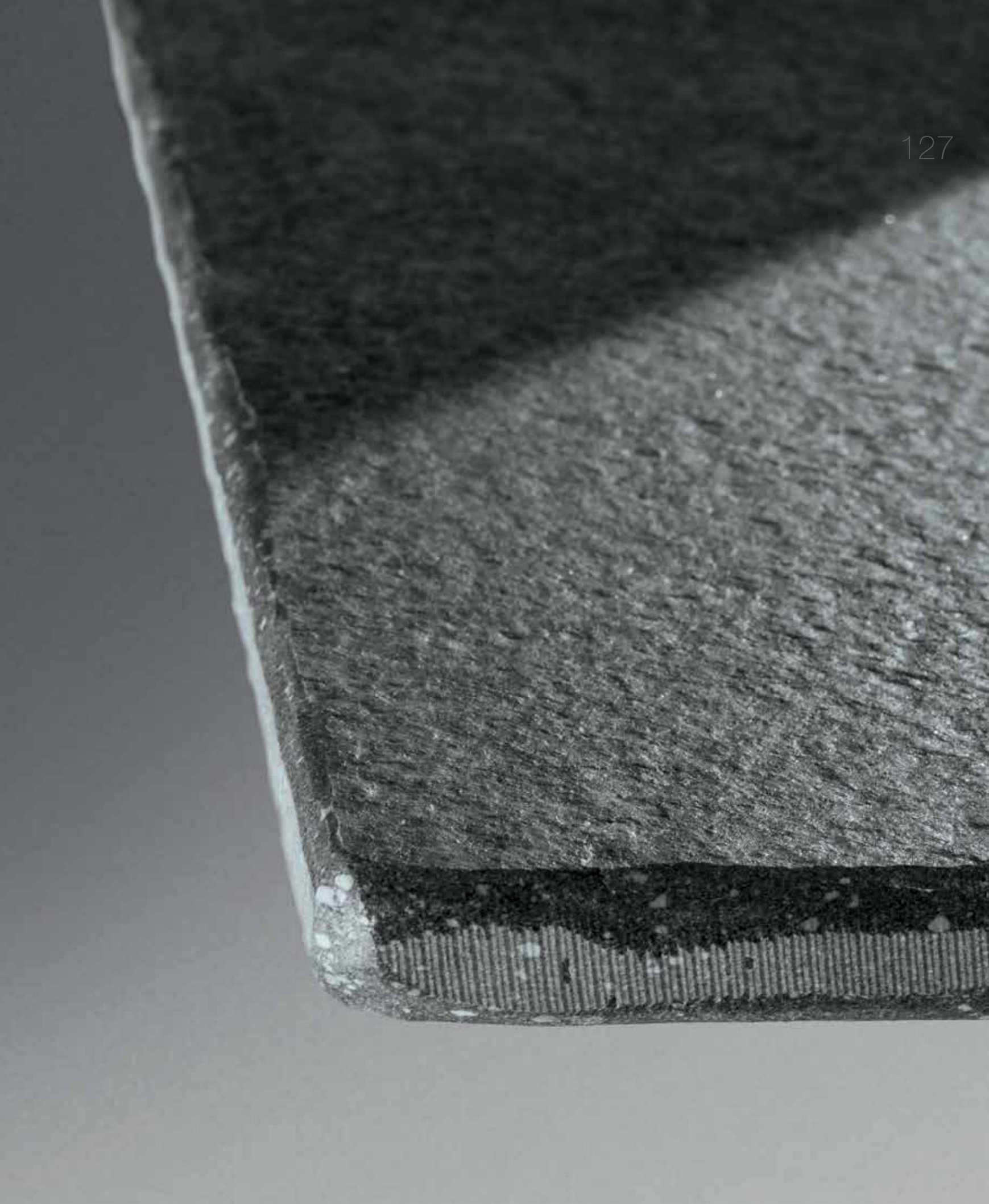

indicazioni di posa LAYING INSTRUCTION

Posa 2 cm in esterno

Conseguentemente alle dimensioni e natura delle lastre in gres porcellanato, alla forma pronunciata del rilievo antiscivolo (che trattiene sempre un velo di acqua), particolare attenzione deve essere data alla % di pendenza e inclinazione, che il cliente vuole dare al piano pavimento nonché alla direzione di posa della lastra in gres. La % di inclinazione e pendenza della pavimentazione deve soddisfare le scelte architettoniche del progetto e le naturali necessità di deflusso delle acque meteoriche. Queste ultime variano in funzione alla zona geografica, all'orientamento ed esposizione della zona interessata, se è completamente scoperta ecc. A titolo esemplificativo e non vincolante l'ufficio UPI svizzero consiglia pendenze non inferiori all'1,5% per metro lineare.

Doghe pre fugate SKE 2.0 e Preinciso Exter 60 x 60 (1 cm)

Conseguentemente alla particolare struttura (basso rilievo preinciso) che riproduce un effetto doghe pre fugate, le dimensioni delle doghe esterne di ogni pezzo possono avere minime differenze dalle doghe interne. Questo dovuto al calibro di produzione che può avere variazioni dimensionali significative ad ogni produzione. Purtroppo questa variazione influenza solo le doghe esterne. Per questo motivo i prodotti in oggetto devono avere delle minime tolleranze estetiche, per migliorare le quali possiamo consigliare le seguenti contromisure:

1. Utilizzare Piedini con crocette di almeno 4 mm, così da avere la stessa dimensione per la fuga. (SKE 2.0) Nella posa tradizionale utilizzare crocette sempre di 4 mm (che in sostanza si tratta di ripetere lo stesso dimensionamento delle fughe interne al pezzo).
2. Posare il materiale seguendo sempre lo stesso verso di produzione (verificabile dal tampone).
3. Adottare lo schema di posa a cesto.

Effetti sulle superfici delle dilatazioni termiche

Le forti escursioni termiche (-15° +70° nelle nostre zone) alle quali sono soggette le COPERTURE PIANE, comportano la necessità di considerarne gli effetti sui materiali da costruzione. Materiali che hanno spesso tra loro differente COEFFICIENTE TERMICO DI DILATAZIONE. Le NORMATIVE prevedono la realizzazione di appositi GIUNTI ELASTICI di DILATAZIONE nelle strutture costruttive, nel perimetro ed nel frazionamento delle solette. Le nostre Pavimentazioni oltre ad avere un PROPRIO COEFFICIENTE TERMICO DI DILATAZIONE e un loro comportamento dinamico, poggiano e vengono pertanto installate su sottofondi e strutture che si muovono. Essi si CONTRAGGONO e si DILATANO in misura anche importante a seconda delle dimensioni per diversi CM. L'effetto che si potrebbe riscontrare anche in relazione alle zone di utilizzo delle pavimentazioni a secco è quello di un disallineamento delle fughe nel Sopraelevato o di sganciamento dei pezzi nel Modulo. Se fossero invece pavimentazioni incollate esse si potrebbero rompere e deteriorarsi. È pertanto indispensabile evitare/limitare l'insorgere di tali inestetismi, eseguendo un abbondante giunto perimetrale ed evitando, ove possibile lo stazionamento di forti pesi/strutture che impedirebbero il corretto movimento della pavimentazione. È indispensabile frazionare la pavimentazione nel caso del Modulo Plastico anche in corrispondenza del cambio di pendenza della soletta. A tale scopo, si consiglia l'uso degli accessori previsti nel catalogo e dei giunti elastici/coprigiunti reperibili normalmente, presso le rivendite specializzate.

Raccomandazioni per la posa sopraelevata del SKE 2.0

Il prodotto Monolitico SKE 2.0 auto portante è sicuramente IDONEO all'uso in esterno per appoggio e sopraelevazione. Non esiste una normativa "specificata" per i prodotti da esterno in gres in sopraelevazione, la più vicina al nostro prodotto è quella relativa ad i manufatti in cemento. A tale normativa il nostro prodotto SKE 2.0 RISPONDE IN MODO MIGLIORATIVO su tutti i test comparativi, ad esempio resiste a +1400 kg per piastra (risultato del test al carico di rottura come da norma EN 1339 KN > 14). Questo vuole dire secondo lo standard adottato, che il materiale è idoneo "ALL'UTILIZZO COLLETTIVO e PUBBLICO SENZA LIMITAZIONE DELL'ALTEZZA DEI PIEDINI o TRAVERSINE".

Se confrontiamo invece il nostro prodotto SKE 2.0 con la normativa da sopraelevato da "INTERNO" il suo PUNTO DEBOLE è la RESISTENZA AL CARICO/URTO DINAMICO da CORPO DURO (caduta di un martello o materiale rigido di almeno 4,5 kg da 40 cm di altezza) EN 12825. Infatti la particolare rigidità del gres a questo tipo di test non ci aiuta, perché la piastra può rompersi o frantumarsi, bisogna pertanto considerare questo rischio e a fronte di ciò consigliare in alcune destinazioni d'uso come officine meccaniche o dove le altezze del pavimento sono superiori ai 10 cm l'utilizzo di protezioni da applicare sul retro delle piastre:

- vaschetta metallica sovrapposta
- vaschetta metallica incollata
- protezione in fibra incollata

Tali applicazioni non aumentano la portata del pavimento, ma sono solo la garanzia contro lo sfondamento e vanno a limitare il rischio di infortunio.

Sollevamento causa vento

Nota bene: nella posa sopraelevata il materiale è stabile grazie al suo peso e alla forza di gravità. È possibile che si possa verificare un sollevamento in circostanze atmosferiche gravose, quali forte vento e tornado. Importante quindi che il progettista verifichi la posizione della pavimentazione rispetto al vento e alla posizione geografica dell'intervento, e conseguentemente deve prevedere soluzioni architettoniche e ancoraggi meccanici ai fini di annullare questa problematica nei contesti sopraindicati.

Laying 2 cm in outdoor

Consequently, the size and nature of the porcelain stoneware slabs, due to the pronounced anti-slip surface (which always retains a thin layer of water), special attention should be given to the slope and inclination %, that the customer wants to give to the floor plan and direction laying of the slab stoneware. The % of slope and slope of the floor must meet the architectural choices of the project and the needs for natural runoff of rainwater. These vary according to the geographical area, orientation and exposure of the affected area, if it is completely bare, etc. etc. By way of example, not binding, of the Swiss office UPI, recommends slopes not less than 1, 5% per linear meter.

The Doghe (grout staves) SKE 2.0 and "Struttura Exter" 60x60 (1 cm)

Consequently the special structure (bas-relief grooves) which reproduces a wood grooves effect the exterior staves dimensions of each piece may have subtle differences from inner staves. This due to the caliber of production that can have significant dimensional variations to each production. Unfortunately this affects the outside slats only. For this reason the products concerned must have a minimum aesthetic tolerances, to improve then we may recommend the following countermeasures:

1. To use pedestals with crosses of at least 4 mm in order to have the same size for the joint (SKE 2.0) In the traditional installation use crosses to 4 mm (the aim is repeating the same internal dimensioning leakage per piece).
2. To lay down the material following always the same production (verifiable from the back of the slab)
3. Adopt the basket diagram laying.

Effects on surface of thermal expansion

The strong thermal excursions (-15° + 70°) which are subjected the FLAT ROOFS, involve the need to consider the effects on building materials. Materials that often have among their different COEFFICIENT of dilatation. The regulations provide for the establishment of special ELASTIC expansion JOINTS in building structures, in the perimeter and in the fractionation of isolets. Our Flooring as well as having its own THERMAL EXPANSION COEFFICIENT and their dynamic behavior, they lay down and are installed on foundations and structures that move. They contract and dilate in measure also important depending on the size even for some cm. The effect that you might encounter in relation to the use of dry flooring is a misalignment of joints in release of raised floor or uncoupling the plastic module. If they would be glued flooring instead, they might break and deteriorate. It is therefore essential to avoid or limiting the occurrence of these flaws, making a large perimeter joints and avoiding, where possible, the stationing of heavy weights/structures that inhibit the correct movement of the flooring. It is necessary to split up the flooring area in the case of plastic module also at the slope change of the base. To do this, it is advisable to use the accessories provided in the catalog and elastic joints/shackles available normally at specialty retailers.

Recommendations for SKE2.0 on elevated installation

The Monolithic product SKE self-carrying 2.0 is definitely suitable for external use for support and elevated installation. There is no specific legislation for outdoor products in porcelain in elevation, the closest to our product is relating to the cement slabs (concrete). To this legislation our SKE 2.0 RESPONDS IMPROVEMENT on all comparative tests, e.g. resists more than 1400 kg per slab (test result as per EN 1339 KN 14 >). This means, according to the adopted standard, the material is suitable for "COLLECTIVE and public use without LIMITATION of the height of the pedestals or sleepers".

If we compare our product SKE 2.0 to the elevated indoor norms, his weakness point is the LOAD/DYNAMIC HARD body SHOCK (for example a hard object fall such as a hammer or other rigid material of less than 4,5 kg from 40 cm height) EN 12825. In fact the particular stiffness of the gres porcelain does not help us, because the gres slab can break or shatter, we must therefore consider this risk and in face of this advise in some uses such as mechanical workshop or where floor heights are higher than the 10 cm using reinforcements to be applied on the back of the slabs :

- overlapping metal tray
- metal tray stuck
- glued fiber protection

These applications do not increase the floor weight capacity, but they are just a guarantee against breakage and limit the risk of accidents.

Wind uplift

Note: in case of pedestal set, the gres porcelain slab is stable thanks to its weight and force of gravity. The bad weather, as strong wind and tornado, could uplift the slab. It is really important that the architect checks the position of the deck surface according to its geographical location and wind direction. He must figure out architectural solutions and mechanical anchorings to avoid the case underlined in the headline.

imballi PACKAGING

SKE 2.0 MONOLITICO	Thickness	Moduli pallet	M ² per pallet	KG per modulo	KG per pallet	ingombro pallet
60x60	20	30	21,60	32	960	80x120xh75 cm
40x120	20	24	23,04	48	1152	100x120xh75 cm
60x120	20	20	14,40	33,40	670	63x124xh65 cm
20x20	20	60	24	17	1020	80x120xh75 cm
20x30	20	66	23,76	15,50	1023	80x120xh75 cm
30x240	18	21	0,72	30,60	662,60	265x136xh40 cm

Un ringraziamento speciale a
Special thanks to

R O D A

and

AK47

KRONOS
C E R A M I C H E

Kronos 2 ceramiche S.p.A.

Sede legale:

Strada delle Fornaci, 20 41126 Modena

Sede amministrativa:

Via Monte Bianco, 3 41042 Fiorano Modenese (Modena) Italy

Tel. 0039 0536 927711

Fax 0039 0536 845608 - Fax Estero 0039 0536 1815811

info@kronos2.it - www.kronosceramiche.it

