



## Appoggio \_ Lay-on

Un grande classico sempre attuale. In spazi diversi, la stessa pratica affidabilità. La serie appoggio Pisa è il perfetto approccio a una cucina multifunzionale. Un bordo squadrato di 3 cm segue e veste la linea del top, per sfoggiare lucentezza e robustezza, senza alterare i profili.

A great timeless classic. In all spaces, the same practice reliability. A reliable and well known wall-mount sink which perfectly fits into a multifunctional kitchen. Its bright and robust 3 cm squared edge impeccably matches its top.







finish/finitura

accessories

code  
drainer right or left /  
gocciolatoio destro o sinistro



- size 800x500 mm
- drain hole 2"
- base  450 mm
- depth  166 mm
- support  30 mm
- finish/finitura  matt/prelucido

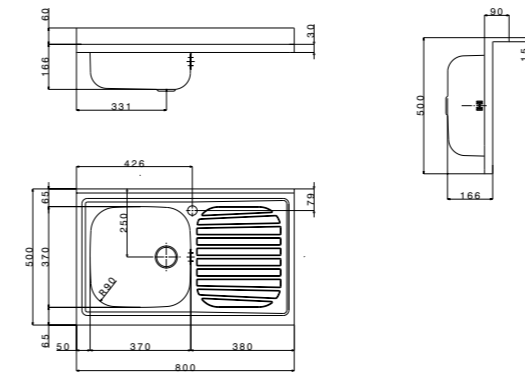





 matt/prelucido

extra **2**

**PI801RPC**  
(dx/right)  
**PI801LPC**  
(sx/left)

 packed in boxes:  
945 x 610 x 280 mm - 5,26 Kg



- size 800x500 mm
- drain hole 2"
- base  800 mm
- depth  166 mm
- support  30 mm
- finish/finitura  matt/prelucido

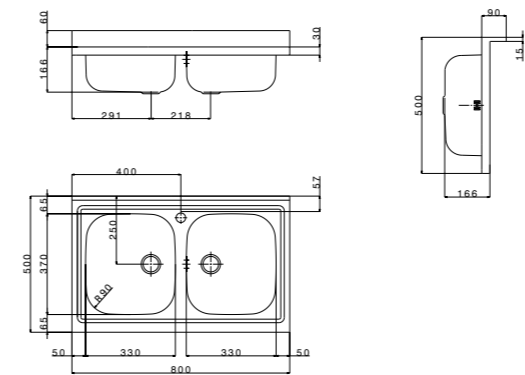





 matt/prelucido

extra **1**

**PI802PC**

 packed in boxes:  
830 x 520 x 225 mm - 5,18 Kg



- size 900x500 mm
- drain hole 2"
- base  450 mm
- depth  166 mm
- support  30 mm
- finish/finitura  matt/prelucido

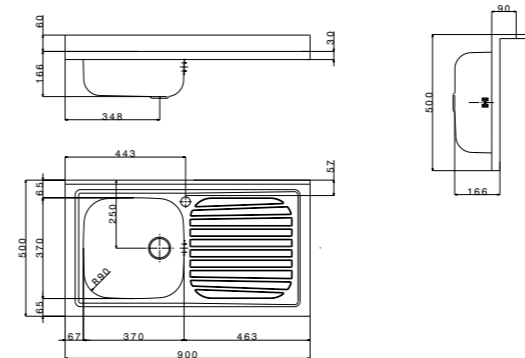

 matt/prelucido

extra **2**

**PI901RPC**  
(dx/right)  
**PI901LPC**  
(sx/left)

 packed in boxes:  
920 x 545 x 230 mm - 4,95 Kg

mixers

accessories



**AP8420CR**



**AP4070CR**



**TLVM33**  
Wood Chopping Board







**TLVQ37**  
Wood Chopping Board

finish/finitura

accessories

code  
drainer right or left /  
gocciolatoio destro o sinistro



- size 900x500 mm
- drain hole 2"
- base  900 mm
- depth  166 mm
- support  30 mm
- finish/finitura  matt/prelucido

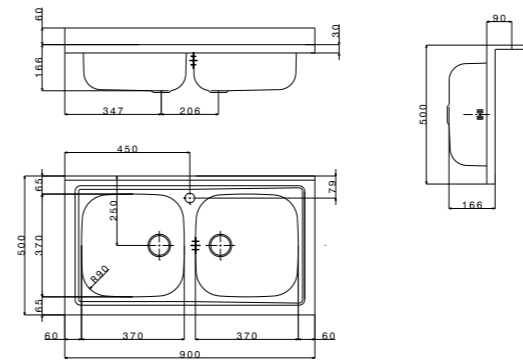





 matt/prelucido

extra **2**

**PI902PC**

 packed in boxes:  
900 x 520 x 200 mm - 8 Kg



- size 1000x500 mm
- drain hole 2"
- base  450 mm
- depth  166 mm
- support  30 mm
- finish/finitura  matt/prelucido

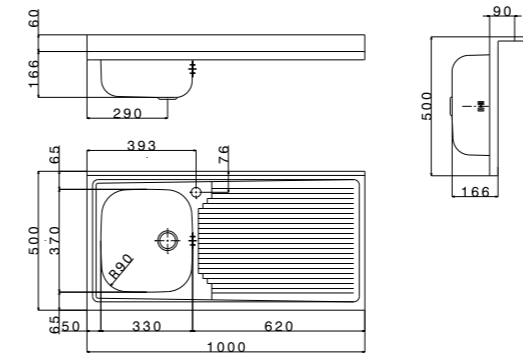





 matt/prelucido

extra **1**

**PI1001RPC**  
*(dx/right)*  
**PI1001LPC**  
*(sx/left)*

 packed in boxes:  
1220 x 540 x 230 mm - 5,75 Kg



- size 1200x500 mm
- drain hole 2"
- base  800 mm
- depth  166 mm
- support  30 mm
- finish/finitura  matt/prelucido

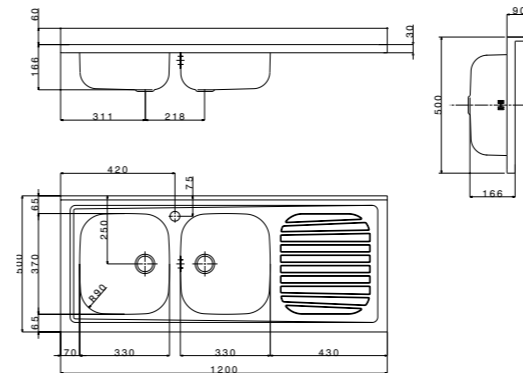

 matt/prelucido

extra **1**

**PI1202MRPC**  
*(dx/right)*  
**PI1202MLPC**  
*(sx/left)*

 packed in boxes:  
1230 x 535 x 235 mm - 6,91 Kg

mixers



**AP8420CR**



**AP4070CR**

accessories



**TLVM33**  
Wood Chopping Board



**TLVQ37**  
Wood Chopping Board