

TABELLA PREZZI FINITURE	pag. 540
INFO TECNICHE	pag. 540
INDICE / INDEX	pag. 542
LAVABO	pag. 547
BIDET	pag. 548
DOCCIA INCASSO	pag. 549
DEVIATORI INCASSO	pag. 550
DOCCIA ESTERNO	pag. 551
DOCCIA ESTERNO THERMOSTATICO	pag. 552
VASCA	pag. 553
BAGNO COMPLEMENTI	pag. 554

PREZZO FINITURE

Calcola il prezzo di listino (IVA esclusa) delle finiture diverse dal cromato, consultando la seguente tabella.

Moltiplicare il **PREZZO LISTINO** per il **COEFFICIENTE MOLTIPLICATORE** della finitura scelta, arrotondando per difetto il prezzo ottenuto (eliminare i centesimi).
ESEMPIO per ordinare art. 0305/C in finitura dorato: codice 04-0305/C

PRICE FINISHES

Include the list price (excluding VAT) of different finishes from chrome, consulting the following table. **Multiply the PRICE LIST MULTIPLIER COEFFICIENT** of the chosen finish, **reducing the price obtained by deleting the centesim.**

EXAMPLE to order art. 0305/C gold finish: code 04-0305/C

COMPOSIZIONE CODICE PER ORDINARE ARTICOLO IN FINITURA



CODICE FINITURA
FINISH CODE

CODICE ARTICOLO
ITEM NUMBER

FINITURE DI SERIE / STANDARD FINISHES

CODICE CODE	DESCRIZIONE FINITURA FINISH DESCRIPTION	MOLTIPLICATORE MULTIPLIER
01-	cromato / chrome	PREZZO LISTINO°
02-	cromo/oro / chrome/gold	x
04-	dorato / gold	x
05-	bronzo satinato / satin bronze	x
06-	rame vecchio / old copper	x
07-	vecchio argento / old silver	x
08-	canna di fucile / gun barrel	x
12-	ottone lucido / polished brass	x
13-	ottone naturale / natural brass	x
14-	bianco / white	x
72-	bronzo opaco / mat bronze	x

FINITURE A RICHIESTA / ON REQUEST FINISHES

CODICE CODE	DESCRIZIONE FINITURA FINISH DESCRIPTION	MOLTIPLICATORE MULTIPLIER
30-	nickel lucido / polished nickel	x
33-	cromo satinato / satin chrome	x
34-	cromo spazzolato / brushing chrome	x
35-	nickel spazzolato / brushing nickel	x
56-	avorio / ivory	x
57-	azzurro / light blue	x
58-	verdino / light green	x
59-	marrone / brown	x
60-	arancio / orange	x
61-	rosso / red	x
66-	bianco opaco / mat white	x
67-	nero opaco / mat black	x
68-	rame opaco / mat copper	x
69-	argento opaco / mat silver	x
71-	oro opaco / mat gold	x
75-	dorato spazzolato / brushing gold	x
87-	oro rosa / pink gold	x
88-	ottone sisal / sisal brass	x

FINITURE A RICHIESTA / ON REQUEST FINISHES

CODICE CODE	DESCRIZIONE FINITURA FINISH DESCRIPTION	MOLTIPLICATORE MULTIPLIER
03-	oro/argento / gold/silver	x
10-	verderame / verdigris	x
11-	nero antracite / anthracite black	x
19-	nero / black	x
28-	nickel satinato / satin nickel	x

°PREZZO DI LISTINO / PRICE LIST

*NON REALIZZABILE / NOT MADE

ATTENZIONE! 13-OTTONE NATURALE e 88-OTTONE SISAL: finiture non protette che antichizzano naturalmente ossidando a contatto con l'umidità atmosferica.
WARNING! 13-NATURAL BRASS and 88-SISAL BRASS: unprotected finishes that naturally oxidise in contact with atmospheric humidity.

PROGETTO SU MISURA: RICHIESTE SPECIALI

I tecnici di Bellosta Rubinetterie sono, inoltre, a disposizione di architetti e designers, per offrire un servizio esclusivo: personalizzazioni di elementi in funzione di specifiche richieste estetiche o problematiche legate a vincoli progettuali, verifica della fattibilità attraverso opportuni studi CAD e sviluppo del disegno tecnico del prodotto speciale richiesto.

Per informazioni e richieste PROGETTI SU MISURA:
 ufficiotecnico@bellostarubinetterie.com



PROGETTO SU MISURA: SPECIAL REQUESTS

Engineers Bellosta Rubinetterie are also available to architects and designers, to offer an exclusive service: customizations of items according to specific aesthetic requirements or issues related to design constraints, verification of the feasibility studies and development through appropriate CAD technical design the required special product. For information and requests "SU MISURA" PROJECTS:
 ufficiotecnico@bellostarubinetterie.com

CONSIGLIO TECNICO

Tutti i miscelatori della collezione ROMINA vengono collaudati nel loro funzionamento al momento dell'assemblaggio. Per garantire la durata delle cartucce nel tempo, si consiglia di spurgare bene l'impianto idraulico prima del montaggio (per rimuovere eventuali detriti) e di installare rubinetti sottolavabo con filtro:

art. 020 o 020/1 per i monofori, art. 020 e art. 029 (tubetti di collegamento con calotta) per i tre fori.

N.B.: Qualora il piano lavabo avesse uno spessore superiore a 2,5 cm specificare la misura al momento dell'ordine.

TECHNICAL ADVICE

All mixers of the ROMINA collection are perfectly tested. To guarantee the perfect functionality of the cartridge for a long time, we advise to clean the sanitary plant before installing the mixer. Moreover we advise to install angle valve with filter:

art. 020 or 020/1 for single hole mixers, art. 020 and art. 029 (pipes with nut 1/2") for three holes mixers

Attention: If the lavatory top is more than cm 2,5 hick, please point it out when placing the order.

FORATURA DEI PIANI SANITARI

I miscelatori lavabo/bidet monoforo prevedono un foro di diametro 35 mm nel piano sanitario. Le batterie lavabo 3 fori sono dotate di vitone ceramico destro con apertura a 1/4 di giro (90°); l'interasse consigliato è di 110 mm e foratura come da schema sottostante.

DRILLING PLANS HEALTH

The sink / hole bidet mixers provide a hole diameter of 35 mm in the health plan. The sink batteries 3 holes are equipped with ceramic cartridge Right-open 1/4 turn (90°); the recommended distance is 110 mm, drilling as per the diagram below.

MONOFORO >>

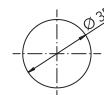

3 FORI >>

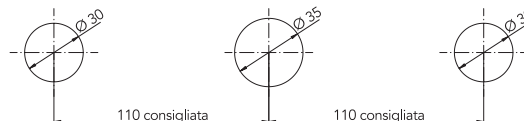

SCHEMA FUNZIONAMENTO DEVIATORI INCASSO 2/3/4 USCITE

Questi deviatori non hanno funzione di chiusura. Ruotando verso destra o sinistra si attivano le uscite. Tra 2 uscite adiacenti durante la rotazione diminuisce la portata dell'uscita iniziale ed incrementa quella della successiva. In posizione intermedia sono entrambe attive a pari portata.

SCHEME OPERATION SWITCHES FLUSH OUTPUT 2/3/4

These diverters have not closing function. By turning to the right or left activates the outputs. Between two adjacent outputs during the rotation decreases the initial output flow and increases that of the next. In position intermediate are both active at the same flow rate.

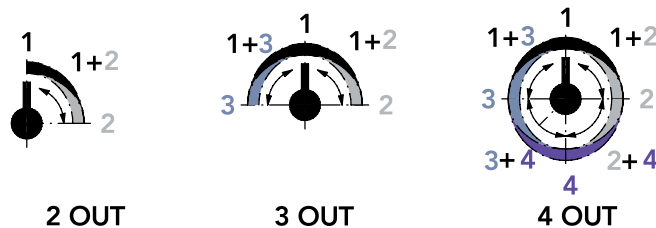

SCHEMA DI APERTURA MISCELATORE INCASSO CON MANIGLIA A CROCE
DIAGRAM FOR OPENING BUILT-IN MIXER WITH CROSS HANDLE

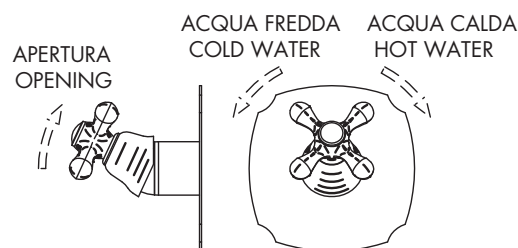

OPTIONAL:

tutta la serie ROMINA viene fornita di serie con la placchetta in metallo, ma è disponibile anche con placchetta porcellana C/F, per l'abbinamento con il colore della rubinetteria e l'ordine vedi tabella a fianco.

OPTIONAL:

The whole ROMINA collection is provided both with metallic and porcelain indices H/C. To combine the indices to the finishing of the taps, please look through the following table.



placchetta porcellana C (acqua calda)

art. 034011



placchetta porcellana F (acqua fredda)

art. 034012

CROMATO

01-034011	€
01-034012	€

ALTRE FINITURE

XX-034011	€	x M*
XX-034012	€	x M*

LEGENDA SIMBOLI

ACCESSORI
ACCESSORIES

- SCARICO C/TAPPO A PRESSIONE
WASTE WITH PRESSURE CAP

RICAMBI IMMEDIATI
IMMEDIATE PARTS

- CARTUCCIA CARTRIDGE
- CARTUCCIA DEVIATRICE DIVERTER CARTRIDGE



CARTUCCIA TERMOSTATICA THERMOSTATIC CARTRIDGE



DEVIATORE DIVERTER



VITONE CERAMICO CERAMIC VALVE



AERATORE TONDO ROUND AERATOR



VITONE TRADIZIONALE TRADITIONAL VALVE



AERATORE PIATTO FLAT AERATOR

LAVABO

0305/C pag. 547
 BATTERIA LAVABO TRE FORI
 3 HOLE BASIN



0305/4/C pag. 547
 BATTERIA LAVABO TRE FORI BOCCA ALTA
 GIREVOLE
 3 HOLE BASIN HIGH SWINGING SPOUT



0305/1/C pag. 547
 GRUPPO LAVABO MONOFORO
 1 HOLE BASIN GROUP



0305/5/C pag. 547
 GRUPPO LAVABO MONOFORO BOCCA ALTA
 1 HOLE BASIN GROUP HIGH SPOUT



0305/2/C pag. 547
 GRUPPO LAVABO MONOFORO BOCCA ALTA
 GIREVOLE
 1 HOLE BASIN GROUP HIGH SWINGING SPOUT



0305/6/C/E + 034075 pag. 548
 GRUPPO LAVABO DA PARETE
 WALL BASIN GROUP



parti esterne / external parts: 0305/6/C/E
 parte incasso / built-in part: 034075

0302/C pag. 548
 RUBINETTO ACQUA SINGOLA MONOFORO
 SINGLE-HOLE WATER FAUCET



0305/3/C pag. 548
 RUBINETTO ACQUA SINGOLA MONOFORO BOCCA
 GIREVOLE
 SINGLE-HOLE WATER FAUCET SWINGING SPOUT



0322/C pag. 548
 RUBINETTO ACQUA SINGOLA DA PARETE
 WALL SINGLE-HOLE WATER FAUCET



BIDET

0307/7/C pag. 548
 BATTERIA BIDET TRE FORI
 3 HOLE BIDET



0307/C pag. 549
 BATTERIA BIDET TRE FORI EROGAZIONE DA
 BORDO
 3 HOLE BIDET WITH BOARD EROGATION



0307/2/C pag. 549
 GRUPPO BIDET MONOFORO
 1 HOLE BIDET GROUP



DOCCIA INCASSO

0300/3/C/E + 034133 pag. 549
 GRUPPO INCASSO C/DEVIATORE 2 USCITE
 BUILT-IN GROUP WITH DIVERTER 2 OUT



parti esterne / external parts: 0300/3/C/E
 parte incasso / built-in part: 034133



0321/M/E + 104018 pag. 549
 MISCELATORE INCASSO
 BUILT-IN MIXER



parti esterne / external parts: 0321/M/E
 parte incasso / built-in part: 104018



DOCCIA INCASSO



0321/M/K/E + 104018 pag. 549

MISCELATORE INCASSO
BUILT-IN MIXER



parti esterne / external parts: 0321/M/K/E
parte incasso / built-in part: 104018



0300/M/E + 104002 pag. 550

MISCELATORE INCASSO C/DEVIATORE 2 USCITE
BUILT-IN MIXER WITH DIVERTER 2 OUT



parti esterne / external parts: 0300/M/E
parte incasso / built-in part: 104002



0300/M/K/E + 104002 pag. 550

MISCELATORE INCASSO C/DEVIATORE 2 USCITE
BUILT-IN MIXER WITH DIVERTER 2 OUT



parti esterne / external parts: 0300/M/K/E
parte incasso / built-in part: 104002

DEVIATORI INCASSO



0303/2/1/E + 914016 pag. 550

DEVIATORE INCASSO 2 USCITE
BUILT-IN DIVERTER 2 OUT



parti esterne / external parts: 0303/2/1/E
parte incasso / built-in part: 914016



0303/2K/E + 914016 pag. 550

DEVIATORE INCASSO 2 USCITE
BUILT-IN DIVERTER 2 OUT



parti esterne / external parts: 0303/2K/E
parte incasso / built-in part: 914016



0303/3/1/E + 034127 pag. 550

DEVIATORE INCASSO 3 USCITE
BUILT-IN DIVERTER 3 OUT



parti esterne / external parts: 0303/3/1/E
parte incasso / built-in part: 034127



0303/3K/E + 034127 pag. 551

DEVIATORE INCASSO 3 USCITE
BUILT-IN DIVERTER 3 OUT



parti esterne / external parts: 0303/3K/E
parte incasso / built-in part: 034127



0303/4/1/E + 034128 pag. 551

DEVIATORE INCASSO 4 USCITE
BUILT-IN DIVERTER 4 OUT



parti esterne / external parts: 0303/4/1/E
parte incasso / built-in part: 034128



0303/4K/E + 034128 pag. 551

DEVIATORE INCASSO 4 USCITE
BUILT-IN DIVERTER 4 OUT



parti esterne / external parts: 0303/4K/E
parte incasso / built-in part: 034128

DOCCIA INCASSO TERMOSTATICO



0312/K/E + 484020 pag. 259*

MISCELATORE TERMOSTATICO INCASSO 1 USCITA
BUILT-IN THERMOSTATIC MIXER 1 OUT



parti esterne / external parts: 0312/K/E
parte incasso / built-in part: 484020



0312/2/K/E + 484021 pag. 259*

MISCELATORE TERMOSTATICO INCASSO C/DEV 2 USCITE
BUILT-IN THERMOSTATIC MIXER WITH DIVERTER 2 OUT



parti esterne / external parts: 0312/2/K/E
parte incasso / built-in part: 484021



0312/3/K/E + 484022 pag. 259*

MISCELATORE TERMOSTATICO INCASSO C/DEV 3 USCITE
BUILT-IN THERMOSTATIC MIXER WITH DIVERTER 3 OUT



parti esterne / external parts: 0312/3/K/E
parte incasso / built-in part: 484022



0312/4/K/E + 484023 pag. 259*

MISCELATORE TERMOSTATICO INCASSO C/DEV 4 USCITE
BUILT-IN THERMOSTATIC MIXER WITH DIVERTER 4 OUT



parti esterne / external parts: 0312/4/K/E
parte incasso / built-in part: 484023

DOCCIA ESTERNO



0309/1/C pag. 551

GRUPPO DOCCIA ESTERNO
EXTERNAL SHOWER GROUP



0309/4/C pag. 552

GRUPPO DOCCIA ESTERNO C/STELO
EXTERNAL SHOWER GROUP WITH PIPE

* ABBINAMENTO CONSIGLIATO: PER PREZZI E SCHEDE TECNICHE, VEDI RIFERIMENTO PAGINA LISTINO REVIVRE

* RECOMMENDED COMBINATION: FOR PRICES AND TECHNICAL DETAILS, LOOK AT PAGE WITH REFERENCE REVIVRE PRICE

DOCCIA ESTERNO



0309/5/1/C pag. 552

GRUPPO DOCCIA ESTERNO C/STELO COMPLETO
EXTERNAL SHOWER GROUP WITH COMPLETE PIPE

DOCCIA ESTERNO TERMOSTATICO



0311/1A/C pag. 552

MISCELATORE DOCCIA ESTERNO TERMOSTATICO
EXTERNAL THERMOSTATIC SHOWER MIXER



0311/4A/C pag. 552

MISCELATORE DOCCIA ESTERNO TERMOSTATICO
C/STELO
EXTERNAL THERMOSTATIC SHOWER MIXER WITH
PIPE



0311/5A/C pag. 552

MISCELATORE DOCCIA ESTERNO TERMOSTATICO
C/STELO COMPLETO
EXTERNAL THERMOSTATIC SHOWER MIXER WITH
COMPLETE PIPE

DOCCIA COMPLEMENTI



0303/1/A pag. 132*

SUPPORTO DOCCIA COMPLETO
FULL SHOWER SUPPORT



0303/1K/A pag. 132*

SUPPORTO DOCCIA COMPLETO
FULL SHOWER SUPPORT



0303/1 pag. 132*

SUPPORTO DOCCIA DUPLEX COMPLETO
FULL SHOWER SUPPORT WITH DUPLEX



1030 pag. 141*

SALISCENDI COMPLETO C/PRESA D'ACQUA
COMPLETE WALL PIPE WITH WATER CONNECTION



1030/1 pag. 146*

ASTA SALISCENDI
WALL PIPE



0513/4 pag. 149*

STELO DOCCIA
ROD SHOWER



0313/5/1 pag. 150*

CURVA PRESA ACQUA C/STELO COMPLETO
CURVE WATER CONNECTOR WITH COMPLETE ROD

VASCA



0301/6/C pag. 553

GRUPPO VASCA ESTERNO
EXTERNAL BATH GROUP



0301/40/C pag. 553

GRUPPO VASCA ESTERNO
EXTERNAL BATH GROUP

VASCA



0301/4/C pag. 553

GRUPPO VASCA C/RACCORDI PER BORDO VASCA
BATH GROUP WITH RIM CONNECTION



0301/2/C pag. 553

BATTERIA PER BORDO VASCA
BATH RIM WITHOUT



0301/20/C pag. 553

BATTERIA PER BORDO VASCA S/BOCCA
BATH RIM WITHOUT SPOUT



0301/40/26/C pag. 554

GRUPPO VASCA C/RACCORDI A PAVIMENTO
BATH GROUP WITH FLOOR CONNECTION



0303 pag. 554

BOCCA VASCA DA PARETE
WALL BATH SPOUT

BAGNO COMPLEMENTI



0308/CC/E + 034034 pag. 554

RUBINETTO D'ARRESTO 1/2"
BUILT-IN STOP COCK 1/2"



parti esterne / external parts: 0308/CC/E
parte incasso / built-in part: 034034 DX



0308/CF/E + 034034 pag. 554

RUBINETTO D'ARRESTO 1/2"
BUILT-IN STOP COCK 1/2"



parti esterne / external parts: 0308/CF/E
parte incasso / built-in part: 034034 DX



0308/CC/E + 034036 pag. 554

RUBINETTO D'ARRESTO 3/4"
BUILT-IN STOP COCK 3/4"



parti esterne / external parts: 0308/CC/E
parte incasso / built-in part: 034036 DX



0308/CF/E + 034036 pag. 555

RUBINETTO D'ARRESTO 3/4"
BUILT-IN STOP COCK 3/4"



parti esterne / external parts: 0308/CF/E
parte incasso / built-in part: 034036 DX



0340/E + 884053 pag. 555

PASSO RAPIDO 3/4"
BUILT-IN RAPID FLOW COCK 3/4"



parti esterne / external parts: 0340/E
parte incasso / built-in part: 884053



0340/K/E + 884053 pag. 555

PASSO RAPIDO 3/4"
BUILT-IN RAPID FLOW COCK 3/4"



parti esterne / external parts: 0340/K/E
parte incasso / built-in part: 884053



0340/E + 884054 pag. 555

PASSO RAPIDO 1"
BUILT-IN RAPID FLOW COCK 1"



parti esterne / external parts: 0340/E
parte incasso / built-in part: 884054



0340/K/E + 884054 pag. 555

PASSO RAPIDO 1"
BUILT-IN RAPID FLOW COCK 1"



parti esterne / external parts: 0340/K/E
parte incasso / built-in part: 884054



0332/2/E + 035212 pag. 556

SARACINESCA
GATE VALVE



parti esterne / external parts: 0332/2/E
parte incasso / built-in part: 035212



0332/2/K/E + 035212 pag. 556

SARACINESCA
GATE VALVE



parti esterne / external parts: 0332/2/K/E
parte incasso / built-in part: 035212



BAGNO COMPLEMENTI

**0320** pag. **556****RUBINETTO SOTTOLAVABO CON FILTRO**
UNDER BASIN TAP WITH FILTER**0321/C** pag. **556****RUBINETTO ATTACCO LAVATRICE**
WALL SINGLE-HOLE WATER FAUCET

0305/C

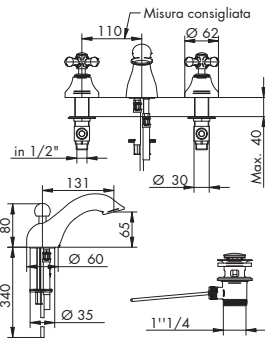

BATTERIA LAVABO TRE FORI

- > vitone ceramico 90°
- > interasse bocca 130
- > erogazione libera senza aeratore
- > senza flessibili di alimentazione
- > con scarico
- > maniglia a croce

 035046
p. 150

CROMATO

01-0305/C

€

ALTRE FINITURE

XX-0305/C

€

x M*

0305/4/C

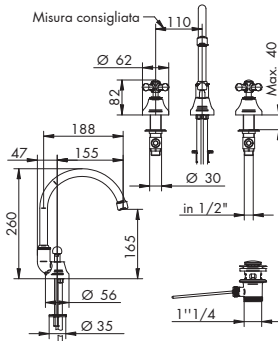

BATTERIA LAVABO TRE FORI BOCCA ALTA GIREVOLE

- > vitone ceramico 90°
- > interasse bocca 155
- > bocca girevole
- > senza flessibili di alimentazione
- > con scarico
- > maniglia a croce

 035046
p. 150

 034013
p. 140

CROMATO

01-0305/4/C

€

ALTRE FINITURE

XX-0305/4/C

€

x M*

0305/1/C

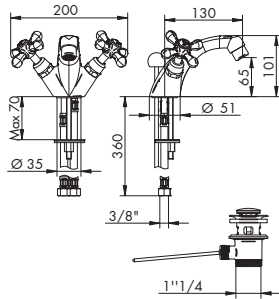

GRUPPO LAVABO MONOFORO

- > vitone ceramico 90°
- > interasse bocca 130
- > flessibili di alimentazione
- > con scarico
- > maniglia a croce

 035046
p. 150

 034013
p. 140

CROMATO

01-0305/1/C

€

ALTRE FINITURE

XX-0305/1/C

€

x M*

0305/5/C

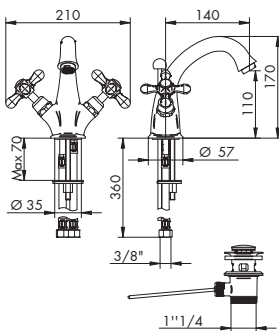

GRUPPO LAVABO MONOFORO BOCCA ALTA

- > vitone ceramico 90°
- > interasse bocca 140
- > flessibili di alimentazione
- > con scarico
- > maniglia a croce

 035046
p. 150

 034013
p. 140

CROMATO

01-0305/5/C

€

ALTRE FINITURE

XX-0305/5/C

€

x M*

0305/2/C

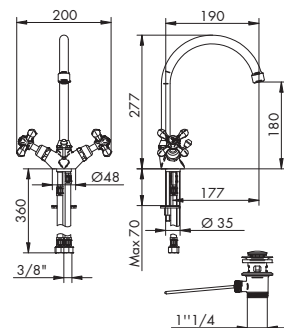

GRUPPO LAVABO MONOFORO BOCCA ALTA GIREVOLE

- > vitone ceramico 90°
- > interasse bocca 177
- > bocca girevole
- > flessibili di alimentazione
- > con scarico
- > maniglia a croce

 035046
p. 150

 034013
p. 140

CROMATO

01-0305/2/C

€

ALTRE FINITURE

XX-0305/2/C

€

x M*

RICAMBI IMMEDIATI



XX = CODICE FINITURA RICHIESTA: per identificare codice corretto vedi pag. 540
M* = MOLTIPLICATORE: per calcolare il prezzo delle altre finiture vedi tabella pag. 540

0305/6/C/E + 034075

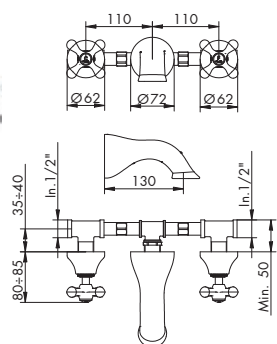

GRUPPO LAVABO DA PARETE

- > vitone ceramico 90°
- > interasse bocca 130
- > erogazione libera senza aeratore
- > ingressi da 1/2"
- > senza scarico
- > maniglia a croce

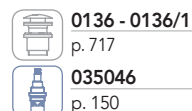

PARTI ESTERNE - CROMATO

01-0305/6/C/E €

PARTI ESTERNE - ALTRE FINITURE

XX-0305/6/C/E € x M*

PARTE INCASSO

034075 info pag. 31 €

PREZZO TOTALE €

0302/C

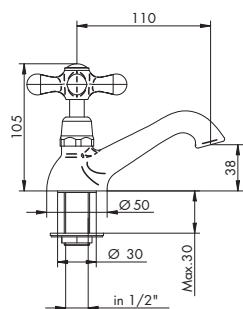

RUBINETTO ACQUA SINGOLA MONOFORO

- > vitone ceramico 90°
- > interasse bocca 110
- > erogazione libera senza aeratore
- > ingresso da 1/2"
- > senza scarico

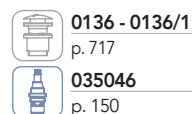

CROMATO

01-0302/C €

ALTRE FINITURE

XX-0302/C € x M*

0305/3/C

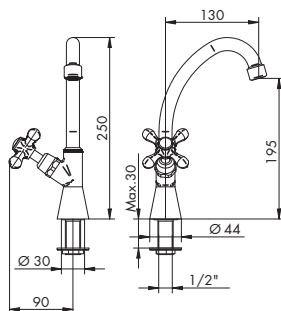

RUBINETTO ACQUA SINGOLA MONOFORO BOCCA GIREVOLE

- > vitone ceramico 90°
- > interasse bocca 130
- > bocca girevole
- > ingresso da 1/2"
- > senza scarico
- > maniglia a croce

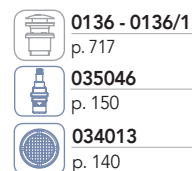

CROMATO

01-0305/3/C €

ALTRE FINITURE

XX-0305/3/C € x M*

0322/C

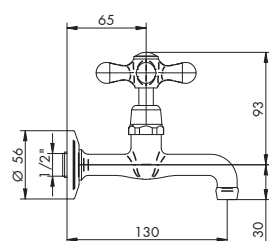

RUBINETTO ACQUA SINGOLA DA PARETE

- > vitone ceramico 90°
- > interasse bocca 130
- > erogazione libera senza aeratore
- > ingresso da 1/2"
- > senza scarico

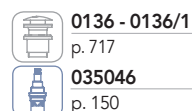

CROMATO

01-0322/C €

ALTRE FINITURE

XX-0322/C € x M*

0307/7/C

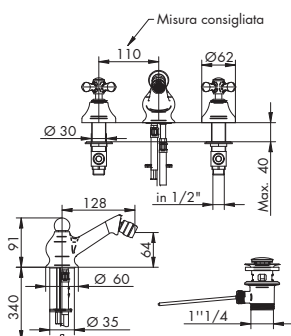

BATTERIA BIDET TRE FORI

- > vitone ceramico 90°
- > interasse bocca 128
- > maniglia a croce
- > aeratore snodato
- > senza flessibili di alimentazione
- > con scarico



CROMATO

01-0307/7/C €

ALTRE FINITURE

XX-0307/7/C € x M*

0307/C

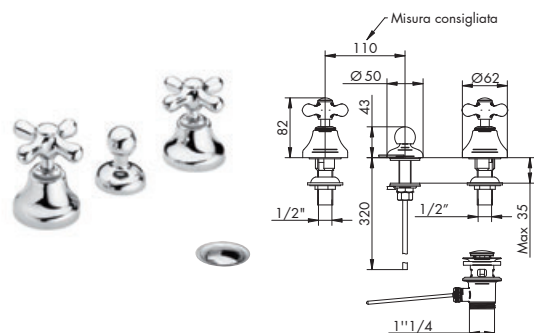

BATTERIA BIDET TRE FORI EROGAZIONE DA BORDO

- > vitone ceramico 90°
- > senza bocca
- > per ceramica con erogazione da bordo
- > senza flessibili di alimentazione
- > con scarico
- > maniglia a croce

035046 p. 150

CROMATO	
01- 0307/C	€

ALTRE FINITURE	
XX-0307/C	€ x M*

0307/2/C

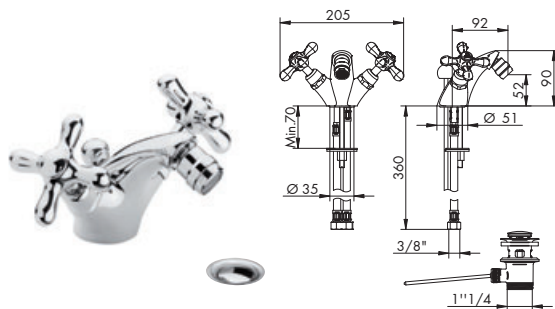

GRUPPO BIDET MONOFORO

- > vitone ceramico 90°
- > interasse bocca 92
- > aeratore snodato
- > flessibili di alimentazione
- > con scarico
- > maniglia a croce

035046 p. 150

034008 p. 140

CROMATO	
01-0307/2/C	€

ALTRE FINITURE	
XX-0307/2/C	€ x M*

0300/3/C/E + 034133

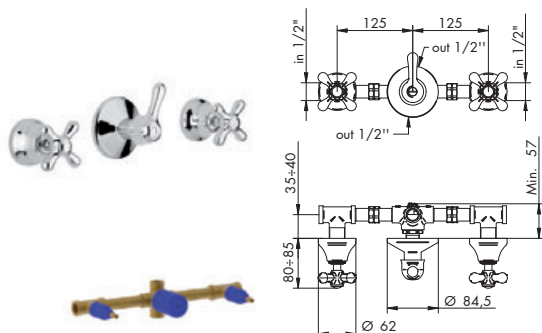

GRUPPO INCASSO C/DEVIATORE 2 USCITE

- > vitone ceramico 90°
- > deviatore a dischi ceramici 2 uscite senza chiusura
- > maniglia a croce
- > attacchi da 1/2"

035046 p. 150

635010 p. 131

035346 fino 9.2017 p. 131

PARTI ESTERNE - CROMATO	
01-0300/3/C/E	€

PARTI ESTERNE - ALTRE FINITURE	
XX-0300/3/C/E	€ x M*

PARTE INCASSO	
034133 info pag. 34	€

PREZZO TOTALE	€
---------------	---

0321/M/E + 104018

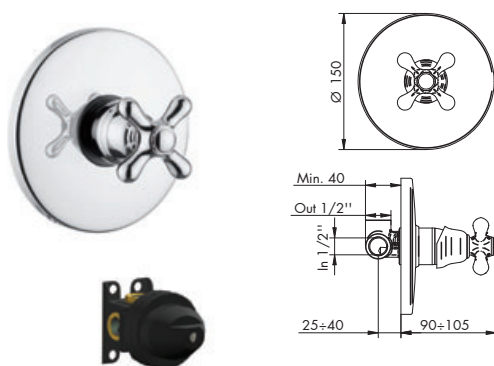

MISCELATORE INCASSO

- > cartuccia tradizionale
- > attacchi da 1/2"
- > uscita superiore
- > incasso con B-Box
- > maniglia a croce

025002 p. 149

PARTI ESTERNE - CROMATO	
01-0321/M/E	€

PARTI ESTERNE - ALTRE FINITURE	
XX-0321/M/E	€ x M*

PARTE INCASSO	
104018 info pag. 36	€

PREZZO TOTALE	€
---------------	---

0321/M/K/E + 104018

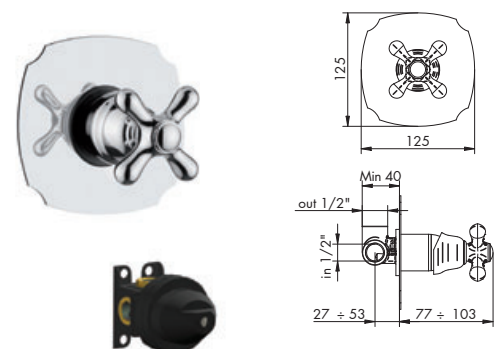

MISCELATORE INCASSO

- > cartuccia tradizionale
- > attacchi da 1/2"
- > uscita superiore
- > incasso con B-Box
- > maniglia a croce
- > piastra classic

025002 p. 149

PARTI ESTERNE - CROMATO	
01-0321/M/K/E	€

PARTI ESTERNE - ALTRE FINITURE	
XX-0321/M/K/E	€ x M*

PARTE INCASSO	
104018 info pag. 36	€

PREZZO TOTALE	€
---------------	---

RICAMBI IMMEDIATI



XX = CODICE FINITURA RICHIESTA: per identificare codice corretto vedi pag. 540
M* = MOLTIPLICATORE: per calcolare il prezzo delle altre finiture vedi tabella pag. 540

0300/M/E + 104002

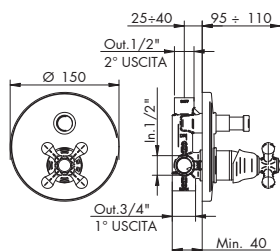

MISCELATORE INCASSO C/DEVIATORE

- > cartuccia tradizionale
- > deviatore a pressione 2 uscite c/ritorno automatico e blocco meccanico basse pressioni
- > attacchi da 1/2"
- > uscita principale inferiore da 3/4"
- > maniglia a croce
- > piastra tonda spessorata
- > incasso con B-Box

025002
p. 149105029
p. 131

PARTI ESTERNE - CROMATO

01-0300/M/E €

PARTI ESTERNE - ALTRE FINITURE

XX-0300/M/E € x M*

PARTE INCASSO

01-104002 info pag. 37 €

PREZZO TOTALE €

0300/M/K/E + 104002

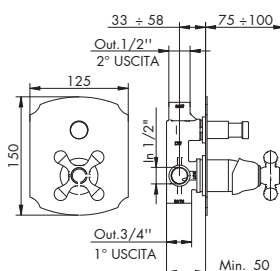

MISCELATORE INCASSO C/DEVIATORE

- > cartuccia tradizionale
- > deviatore a pressione 2 uscite c/ritorno automatico e blocco meccanico basse pressioni
- > piastra classic
- > uscita principale inferiore da 3/4"
- > incasso con B-Box
- > maniglia a croce
- > attacchi da 1/2"

025002
p. 149105029
p. 131

PARTI ESTERNE - CROMATO

01-0300/M/K/E €

PARTI ESTERNE - ALTRE FINITURE

XX-0300/M/K/E € x M*

PARTE INCASSO

01-104002 info pag. 37 €

PREZZO TOTALE €

0303/2/1/E + 914016

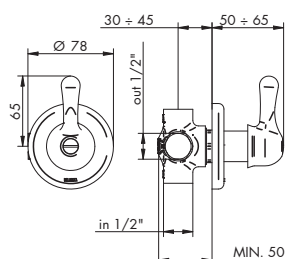

DEVIATORE INCASSO 2 USCITE

- > deviatore a dischi ceramici 2 uscite senza chiusura
- > attacchi da 1/2"

635010
p. 131035346 fino 9.2017
p. 131

PARTI ESTERNE - CROMATO

01-0303/2/1/E €

PARTI ESTERNE - ALTRE FINITURE

XX-0303/2/1/E € x M*

PARTE INCASSO

914016 info pag. 38 €

PREZZO TOTALE €

0303/2K/E + 914016

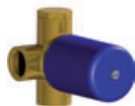
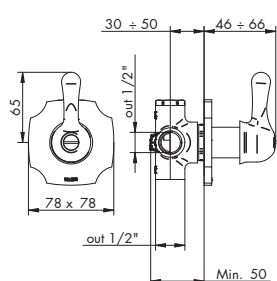

DEVIATORE INCASSO 2 USCITE

- > deviatore a dischi ceramici 2 uscite senza chiusura
- > attacchi da 1/2"
- > piastra classic

635010
p. 131035346 fino 9.2017
p. 131

PARTI ESTERNE - CROMATO

01-0303/2K/E €

PARTI ESTERNE - ALTRE FINITURE

XX-0303/2K/E € x M*

PARTE INCASSO

914016 info pag. 38 €

PREZZO TOTALE €

0303/3/1/E + 034127

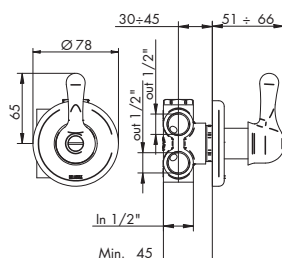

DEVIATORE INCASSO 3 USCITE

- > deviatore a dischi ceramici 3 uscite senza chiusura
- > attacchi da 1/2"

635011
p. 131035345 fino 9.2017
p. 131

PARTI ESTERNE - CROMATO

01-0303/3/1/E €

PARTI ESTERNE - ALTRE FINITURE

XX-0303/3/1/E € x M*

PARTE INCASSO

034127 info pag. 38 €

PREZZO TOTALE €



CARTUCCIA



CARTUCCIA DEVIATRICE



DEVIATORE

0303/3K/E + 034127

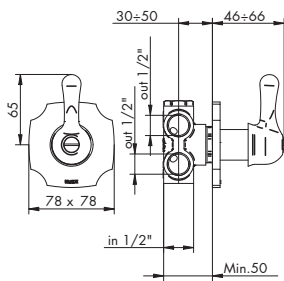
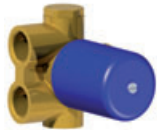

DEVIATORE INCASSO 3 USCITE

- > deviatore a dischi ceramici 3 uscite senza chiusura
- > attacchi da 1/2"
- > piastra classic

635011
p. 131

035345 fino 9.2017
p. 131

PARTI ESTERNE - CROMATO	
01-0303/3K/E	€
PARTE INCASSO	
034127	info pag. 38 €
PREZZO TOTALE	€

PARTI ESTERNE - ALTRE FINITURE	
XX-0303/3K/E	€ x M*

0303/4/1/E + 034128

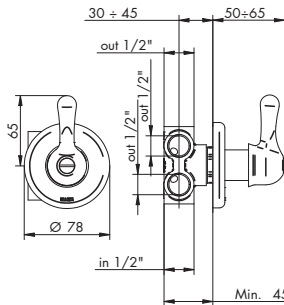
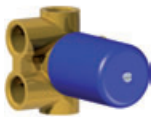

DEVIATORE INCASSO 4 USCITE

- > deviatore a dischi ceramici 4 uscite senza chiusura
- > attacchi da 1/2"

635012
p. 131

035344 fino 9.2017
p. 131

PARTI ESTERNE - CROMATO	
01-0303/4/1/E	€
PARTE INCASSO	
034128	info pag. 38 €
PREZZO TOTALE	€

PARTI ESTERNE - ALTRE FINITURE	
XX-0303/4/1/E	€ x M*

0303/4K/E + 034128

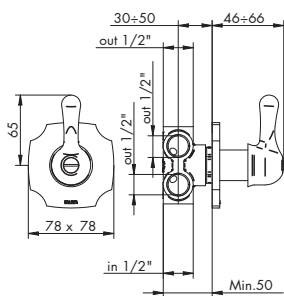
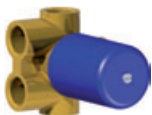

DEVIATORE INCASSO 4 USCITE

- > deviatore a dischi ceramici 4 uscite senza chiusura
- > attacchi da 1/2"
- > piastra classic

635012
p. 131

035344 fino 9.2017
p. 131

PARTI ESTERNE - CROMATO	
01-0303/4K/E	€
PARTE INCASSO	
034128	info pag. 38 €
PREZZO TOTALE	€

PARTI ESTERNE - ALTRE FINITURE	
XX-0303/4K/E	€ x M*

I DOCCIA INCASSO TERMOSTATICO CONSIGLIATI SONO PRESENTI SU LISTINO REVIVRE

- 0312/K/E + 484020
- 0312/2/K/E + 484021
- 0312/3/K/E + 484022
- 0312/4/K/E + 484023

I DOCCIA COMPLEMENTI CONSIGLIATI SONO PRESENTI SU LISTINO REVIVRE

- 0303/1/A 1030/1
- 0303/1 0513/4
- 0303/1K/A 0313/5/1
- 1030

0309/1/C

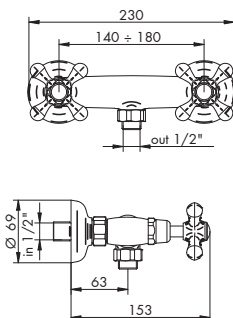

GRUPPO DOCCIA ESTERNO

- > vitone ceramico 90°
- > senza set doccia
- > attacchi da 1/2"
- > maniglia a croce

035046
p. 150

CROMATO	
01-0309/1/C	€

ALTRE FINITURE	
XX-0309/1/C	€ x M*

RICAMBI IMMEDIATI

- CARTUCCIA
- VITONE CERAMICO
- CARTUCCIA DEVIATRICE

XX = CODICE FINITURA RICHIESTA: per identificare codice corretto vedi pag. 540
M* = MOLTIPLICATORE: per calcolare il prezzo delle altre finiture vedi tabella pag. 540

0309/4/C

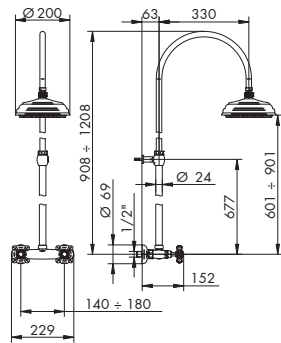

GRUPPO DOCCIA ESTERNO C/STELO

- > vitone ceramico 90°
- > stelo regolabile
- > soffione orientabile Ø200 in ottone senza anticalcare
- > attacchi da 1/2"
- > maniglia a croce

035046
p. 150

CROMATO

01-0309/4/C

€

ALTRE FINITURE

XX-0309/4/C

€

x M*

0309/5/1/C

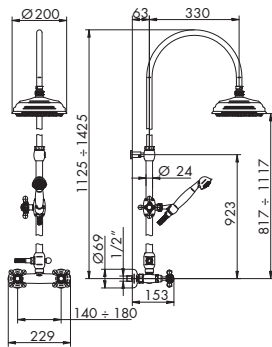

GRUPPO DOCCIA ESTERNO C/STELO COMPLETO

- > vitone ceramico 90°
- > stelo regolabile
- > deviatore a trazione c/ritorno automatico e blocco meccanico bassa pressione
- > soffione Ø200 in ottone senza anticalcare
- > flessibile in ottone 150 cm
- > attacchi da 1/2"
- > doccetta monogetto in metallo senza anticalcare manico in porcellana Ø52
- > supporto doccetta scorrevole
- > maniglia a croce

035046
p. 150

CROMATO

01-0309/5/1/C

€

ALTRE FINITURE

XX-0309/5/1/C

€

x M*

0311/1A/C

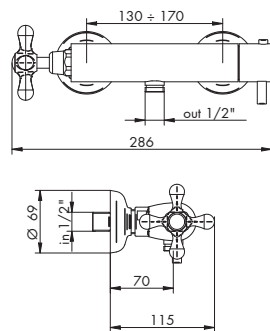

MISCELATORE DOCCIA ESTERNO

- > cartuccia termostatica
- > vitone ceramico 90°
- > senza set doccia
- > attacchi da 1/2"
- > maniglia a croce

885041
p. 150034041
p. 150

CROMATO

01-0311/1A/C

€

ALTRE FINITURE

XX-0311/1A/C

€

x M*

0311/4A/C

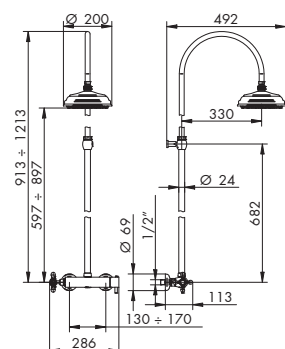

MISCELATORE DOCCIA ESTERNO C/STELO

- > cartuccia termostatica
- > stelo regolabile
- > soffione orientabile Ø200 in ottone senza anticalcare
- > attacchi da 1/2"
- > maniglia a croce

885041
p. 150034041
p. 150

CROMATO

01-0311/4A/C

€

ALTRE FINITURE

XX-0311/4A/C

€

x M*

0311/5A/C

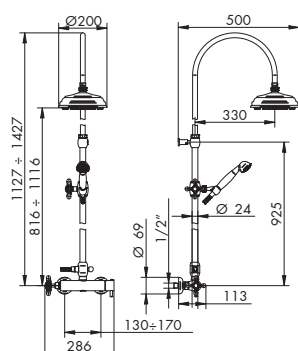

MISCELATORE DOCCIA ESTERNO C/STELO

- > cartuccia termostatica
- > stelo regolabile
- > deviatore a trazione c/ritorno automatico e blocco meccanico bassa pressione
- > soffione Ø200 in ottone senza anticalcare
- > flessibile in ottone 150 cm
- > supporto doccetta scorrevole
- > attacchi da 1/2"
- > doccetta monogetto in metallo senza anticalcare manico in porcellana Ø52
- > maniglia a croce

885041
p. 150034041
p. 150105029
p. 131

CROMATO

01-0311/5A/C

€

ALTRE FINITURE

XX-0311/5A/C

€

x M*



0301/6/C

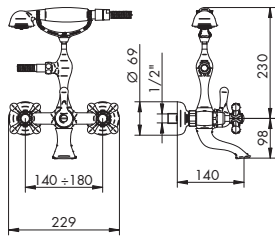

GRUPPO VASCA ESTERNO

- > vitone ceramico 90°
- > erogazione libera senza aeratore
- > Interasse bocca 140
- > deviatore manuale senza ritorno automatico
- > flessibile in metallo 150 cm
- > attacchi da 1/2" > maniglia a croce
- > doccetta monogetto in metallo senza anticalcare manico in porcellana Ø52

035046
p. 150

CROMATO	ALTRE FINITURE
01-0301/6/C €	XX-0301/6/C € x M*

0301/40/C

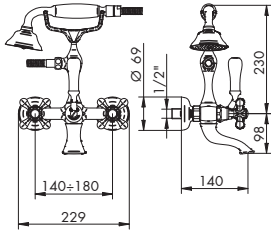

GRUPPO VASCA ESTERNO

- > vitone ceramico 90°
- > erogazione libera senza aeratore
- > Interasse bocca 140
- > deviatore manuale senza ritorno automatico
- > flessibile in metallo 150 cm
- > attacchi da 1/2"
- > maniglia a croce
- > doccetta monogetto in metallo senza anticalcare manico in porcellana Ø77

035046
p. 150

CROMATO	ALTRE FINITURE
01-0301/40/C €	XX-0301/40/C € x M*

0301/4/C

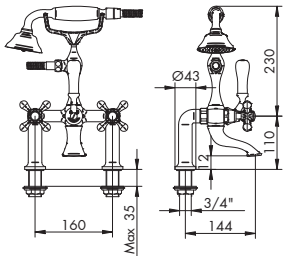

GRUPPO VASCA C/RACCORDI PER BORDO VASCA

- > vitone ceramico 90°
- > erogazione libera senza aeratore
- > Interasse bocca 144
- > deviatore manuale senza ritorno automatico
- > flessibile in metallo 150 cm
- > attacchi da 3/4"
- > maniglia a croce
- > doccetta monogetto in metallo senza anticalcare manico in porcellana Ø77

035046
p. 150

CROMATO	ALTRE FINITURE
01-0301/4/C €	XX-0301/4/C € x M*

0301/2/C

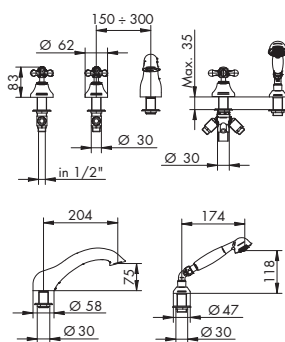

BATTERIA PER BORDO VASCA

- > vitone ceramico 90°
- > erogazione libera senza aeratore
- > Interasse bocca 204
- > deviatore a dischi ceramici 2 uscite
- > flessibile in metallo 150 cm
- > flessibili di alimentazione
- > senza scarico > maniglia a croce
- > doccetta monogetto in metallo senza anticalcare manico in porcellana Ø52
- > PREDISPOSIZIONI per bordo vasca, art. 012/5, 012/6 e 012/7, vedi pag. 615

035046
p. 150

CROMATO	ALTRE FINITURE
01-0301/2/C €	XX-0301/2/C € x M*

0301/20/C

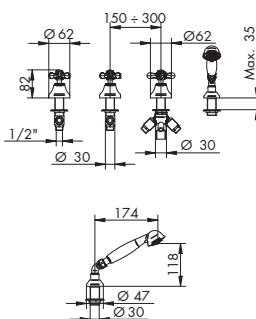

BATTERIA PER BORDO VASCA S/BOCCA

- > vitone ceramico 90°
- > senza bocca
- > deviatore a dischi ceramici 2 uscite
- > flessibile in metallo 150Cm
- > flessibili di alimentazione
- > senza scarico
- > maniglia a croce
- > doccetta monogetto in metallo senza anticalcare manico in porcellana Ø52
- > PREDISPOSIZIONI per bordo vasca, art. 012/4, 012/6 e 012/7, vedi pag. 615

035046
p. 150

CROMATO	ALTRE FINITURE
01-0301/20/C €	XX-0301/20/C € x M*

0301/40/26/C

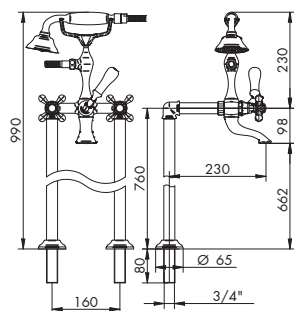

GRUPPO VASCA C/RACCORDI A PAVIMENTO

- > vitone ceramico 90°
- > erogazione libera senza aeratore
- > Interasse bocca 230
- > deviatore manuale senza ritorno automatico
- > flessibile in metallo 150 cm
- > attacchi da 3/4"
- > maniglia a croce
- > doccetta monogetto in metallo senza anticalcare manico in porcellana Ø77
- > PREDISPOSIZIONI per gruppo vasca c/raccordi a pavimento, art. 084058, vedi pag. 734

035046
p. 150

CROMATO	ALTRE FINITURE
01-0301/40/26/C €	XX-0301/40/26/C € x M*

0303

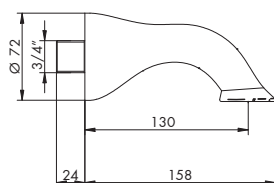

BOCCA VASCA DA PARETE

- > interasse bocca 130
- > erogazione libera senza aeratore
- > attacco da 3/4"

CROMATO	ALTRE FINITURE
01-0303 €	XX-0303 € x M*

0308/CC/E + 034034 DX

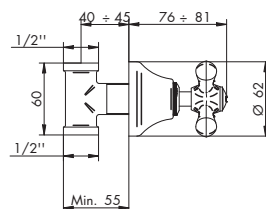

RUBINETTO D'ARRESTO 1/2"

- > vitone ceramico 90°
- > placchetta con scritta "C"
- > ingressi da 1/2"

035046
p. 150

PARTI ESTERNE - CROMATO	PARTI ESTERNE - ALTRE FINITURE
01-0308/CC/E €	XX-0308/CC/E € x M*
PARTE INCASSO	
034034 info pag. 39 €	
PREZZO TOTALE €	

0308/CF/E + 034034 DX

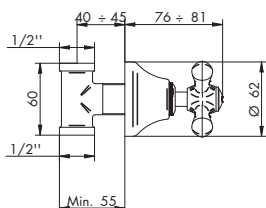

RUBINETTO D'ARRESTO 1/2"

- > vitone ceramico 90°
- > placchetta con scritta "F"
- > ingressi da 1/2"

035046
p. 150

PARTI ESTERNE - CROMATO	PARTI ESTERNE - ALTRE FINITURE
01-0308/CF/E €	XX-0308/CF/E € x M*
PARTE INCASSO	
034034 info pag. 39 €	
PREZZO TOTALE €	

0308/CC/E + 034036 DX

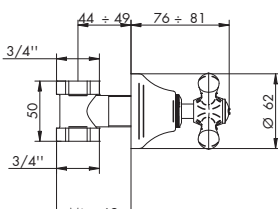

RUBINETTO D'ARRESTO 3/4"

- > vitone ceramico 90°
- > placchetta con scritta "C"
- > ingressi da 3/4"

035046
p. 150

PARTI ESTERNE - CROMATO	PARTI ESTERNE - ALTRE FINITURE
01-0308/CC/E €	XX-0308/CC/E € x M*
PARTE INCASSO	
034036 info pag. 39 €	
PREZZO TOTALE €	

0308/CF/E + 034036 DX

RUBINETTO D'ARRESTO 3/4"

- > vitone ceramico 90°
- > placchetta con scritta "F"
- > ingressi da 3/4"

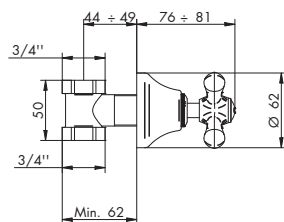
 035046
p. 150

PARTI ESTERNE - CROMATO

01-0308/CF/E €

PARTI ESTERNE - ALTRE FINITURE

XX-0308/CF/E € x M*

PARTE INCASSO

034036 info pag. 39 €

PREZZO TOTALE €

0340/E + 884053

PASSO RAPIDO 3/4"

- > vitone tradizionale
- > abbinare a saracinesca
- > ingressi da 3/4"

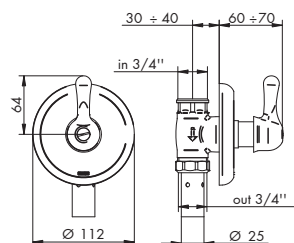
 884021
p. 151

PARTI ESTERNE - CROMATO

01-0340/E €

PARTI ESTERNE - ALTRE FINITURE

XX-0340/E € x M*

PARTE INCASSO

884053 info pag. 42 €

PREZZO TOTALE €

0340/K/E + 884053

PASSO RAPIDO 3/4"

- > vitone tradizionale
- > abbinare a saracinesca
- > piastra classic
- > ingressi da 3/4"

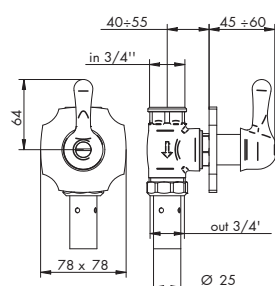
 884021
p. 151

PARTI ESTERNE - CROMATO

01-0340/K/E €

PARTI ESTERNE - ALTRE FINITURE

XX-0340/K/E € x M*

PARTE INCASSO

884053 info pag. 42 €

PREZZO TOTALE €

0340/E + 884054

PASSO RAPIDO 1"

- > vitone tradizionale
- > abbinare a saracinesca
- > ingressi da 1"

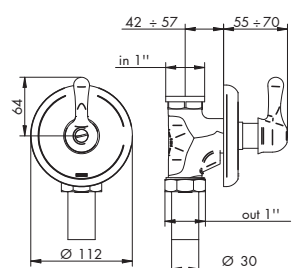
 884021
p. 151

PARTI ESTERNE - CROMATO

01-0340/E €

PARTI ESTERNE - ALTRE FINITURE

XX-0340/E € x M*

PARTE INCASSO

884054 info pag. 42 €

PREZZO TOTALE €

0340/K/E + 884054

PASSO RAPIDO 1"

- > vitone tradizionale
- > abbinare a saracinesca
- > piastra classic
- > ingressi da 1"

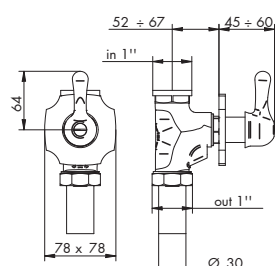
 884021
p. 151

PARTI ESTERNE - CROMATO

01-0340/K/E €

PARTI ESTERNE - ALTRE FINITURE

XX-0340/K/E € x M*

PARTE INCASSO

884054 info pag. 42 €

PREZZO TOTALE €

RICAMBI IMMEDIATI



XX = CODICE FINITURA RICHIESTA: per identificare codice corretto vedi pag. 540
M* = MOLTIPLICATORE: per calcolare il prezzo delle altre finiture vedi tabella pag. 540

0332/2/E + 035212

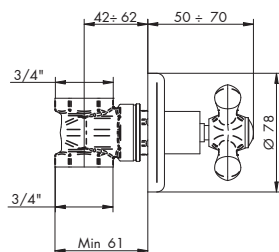

SARACINESCA

- > attacchi da 3/4"
- > maniglia a croce

PARTI ESTERNE - CROMATO

01-0332/2/E €

PARTE INCASSO

035212 info pag. 42 €

PREZZO TOTALE €

PARTI ESTERNE - ALTRE FINITURE

XX-0332/2/E € x M*

0332/2/K/E + 035212

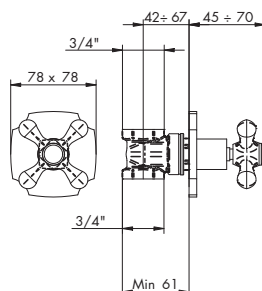

SARACINESCA

- > attacchi da 3/4"
- > piastra classic
- > maniglia a croce

PARTI ESTERNE - CROMATO

01-0332/2/K/E €

PARTE INCASSO

035212 info pag. 42 €

PREZZO TOTALE €

PARTI ESTERNE - ALTRE FINITURE

XX-0332/2/K/E € x M*

0320

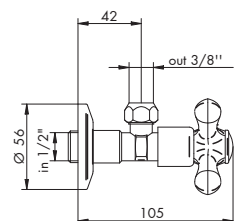

RUBINETTO SOTTOLAVABO CON FILTRO

- > attacco a parete da 1/2"
- > per collegamento flessibili 3/8" o tubetti Ø10
- > filtro interno per raccolta macro impurità
- > maniglia a croce

CROMATO

01-0320 €

ALTRE FINITURE

XX-0320 € x M*

0321/C

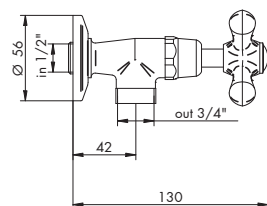

RUBINETTO ATTACCO LAVATRICE

- > attacco a parete da 1/2"
- > per collegameneto tubo 3/4"
- > maniglia a croce

CROMATO

01-0321/C €

ALTRE FINITURE

XX-0321/C € x M*

