

SEVEN



h u m a n & n a t u r e





h u m a n & n a t u r e

Seven, memories of nature in human live

SEVEN, HUMAN & NATURE / SEVEN, EL HOMBRE Y LA NATURALEZA	4
The birth of Seven / El nacimiento de Seven	6
Inspiration for the Seven colours / La inspiración de los colores Seven	8
SevenTotal look / Seven, una visión total	10
COLLECTION / LA COLECCIÓN	12
Beige	14
Sand	24
Hazelnut	34
Pearl	42
Silver	52
Grey	60
Dark Grey	70
DECORS & SPECIAL PIECES / Decorados y piezas especiales	80
SPECIFICATIONS / ESPECIFICACIONES	96
Colours, finishes and formats / Colores, acabados y formatos	98
Packing and technical features / Packing y características técnicas	100
Certifications and awards / Certificados y distinciones	106



“By connecting with nature, we conquer our true essence ”

Since the dawn of time, humans have considered themselves to be superior, almighty beings that know and control everything. But everything we know, understand and have been taught is limited knowledge.

Humans are just a snippet of matter in an unexplored, infinite universe. A microcosm within the macrocosm.

Building on the intelligence and perfection of nature – whose unmeasurable character and the operation of its precise machinery we'll never manage to fully grasp – we welcome Seven, or the seven elements that govern the course and progression of nature.

Only by entrusting ourselves to these seven elements can we open up our minds and heal our unconsciousness, enriching ourselves internally and connecting with our inner beings. Throwing caution to the wind and letting our hearts guide us.

Are you ready to immerse yourself in the dream world of Seven?

Desde los inicios de la historia de la humanidad, el ser humano se ha considerado un ser superior, todopoderoso; saberlo y controlarlo todo. Pero aquello que sabemos, conocemos y nos han enseñado, es un conocimiento limitado.

El hombre es tan solo una pequeña porción de materia en un universo inexplorado, infinito. Un microcosmos dentro del macrocosmos.

Fundamentándonos en la inteligencia y perfección de la naturaleza –cuyo carácter inconmensurable y funcionamiento de su milimétrico engranaje no alcanzamos realmente a comprender– nos acogemos a Seven o esos siete elementos que rigen el transcurso y devenir de la naturaleza.

Solo encomendándonos a esos siete elementos podremos abrir nuestra mente y sanar de la inconsciencia, enriquecernos internamente y conectarnos con nuestro interior. Echar a un lado la razón y dejar fluir al corazón.

¿Preparado para sumergirte en el universo onírico de Seven?

“Conectando con la naturaleza conquistamos nuestra verdadera esencia ”

SEVEN, HUMAN & NATURE

SEVEN, EL HOMBRE Y LA NATURALEZA



e a r t h

s o u n d

w a t e r

7

a i r

f i r e

l i g h t

d r e a m s

SEVEN



h u m a n & n a t u r e

We found our inspiration to create Seven in nature and its connection with the very core of human essence.

Air, earth, water, fire, sound or light are elements we've shared a connection with since life began, but only through our imagination, our emotions and ability to go beyond the status quo, have we been able to make them our own.

Seven closes the circle in man's connection with nature, offering neutral colours and exquisitely textured finishes that, together with the versatility and great performance of our products, allow us to transfer what is most valuable in our environment to any type of project.

Seven, a new way of feeling.

Nos hemos inspirado en la naturaleza y su conexión con lo más profundo de la esencia humana para crear Seven.







El aire, la tierra, el agua, el fuego, el sonido o la luz son elementos que se encuentran unidos a nosotros desde el origen de la vida, pero solo mediante nuestra imaginación, nuestras emociones, y capacidad para ir más allá de lo establecido hemos sido capaces de hacerlos nuestros.

Seven cierra el círculo en la conexión del hombre con la naturaleza, ofreciendo colores neutros y acabados exquisitamente matéricos que, unidos a la versatilidad y grandes prestaciones de nuestros productos, permiten trasladar lo más valioso de nuestro entorno a cualquier tipo de proyecto.

Seven, una nueva forma de sentir.



SEVEN

<p>Earth</p>	<p>Beige is balance, roots. Feeling stable and safe, on solid ground. Beige es equilibrio, raíces. Sentirse estable y seguro, en tierra firme.</p>	<p>h a r m o n y </p>
<p>Air</p>	<p>Sand recalls a desire to love nature. It provides us with resources. Without it, we wouldn't exist. Sand recuerda el deseo de amar la naturaleza. Nos surte de recursos. Sin ella no existimos.</p>	<p>l o v e </p>
<p>Fire</p>	<p>Hazelnut is action, power, strength. Investing purpose and passion in whatever is undertaken. Hazelnut es acción, poder, fuerza. Poner intención y pasión en todo aquello que se emprenda.</p>	<p>p o w e r </p>
<p>Light</p>	<p>Pearl represents light, vision. Glimpses of the way forward, towards decision-making. Pearl representa la luz, la visión. Vislumbrar el camino hacia el futuro, hacia la toma de decisiones.</p>	<p>i n s i g h t </p>
<p>Water</p>	<p>Silver represents freshness, emotion. The excitement of seeing something unusual, of doing something new. Silver representa frescura, emoción. La ilusión de ver algo insólito, de realizar algo por primera vez.</p>	<p>e m o t i o n </p>
<p>Dreams</p>	<p>Grey is creativity, imagination, dreams, being carried away by the unexplored and the inexplorable. Grey es la creatividad, la imaginación, los sueños, el dejarse llevar hacia lo inexplorado e inexplorable.</p>	<p>i m a g i n a t i o n </p>
<p>Sound</p>	<p>Dark Grey is spirit, fortitude, coherence. The conscience that guides us to take the right path. Dark Grey es el talante, el temple, la coherencia. La conciencia que nos guía a tomar el camino correcto.</p>	<p>c o h e r e n c e </p>





7

T o t a l l o o k

Everything in the human being is affected by emotions. By the seven elements of nature, born within our souls to perfectly coexist with reason – which is what governs our movements in a precise, clinical way. Like a single component. Like a whole. The same “whole” under which Seven operates, a collection full of formats and aesthetics to adapt to any architectural challenge and provide 360° solutions for projects.

Todo en el ser humano está afectado por las emociones. Por los siete elementos de la naturaleza, que nacen de nuestra alma para convivir de forma perfecta con la razón, que es quien rige nuestros movimientos de forma milimétrica, clínica. Como un único componente. Como un todo. El mismo ‘todo’ bajo el que funciona Seven, una colección colmada de formatos y estéticas para adaptarse a cualquier reto arquitectónico y aportar soluciones 360° para los proyectos.

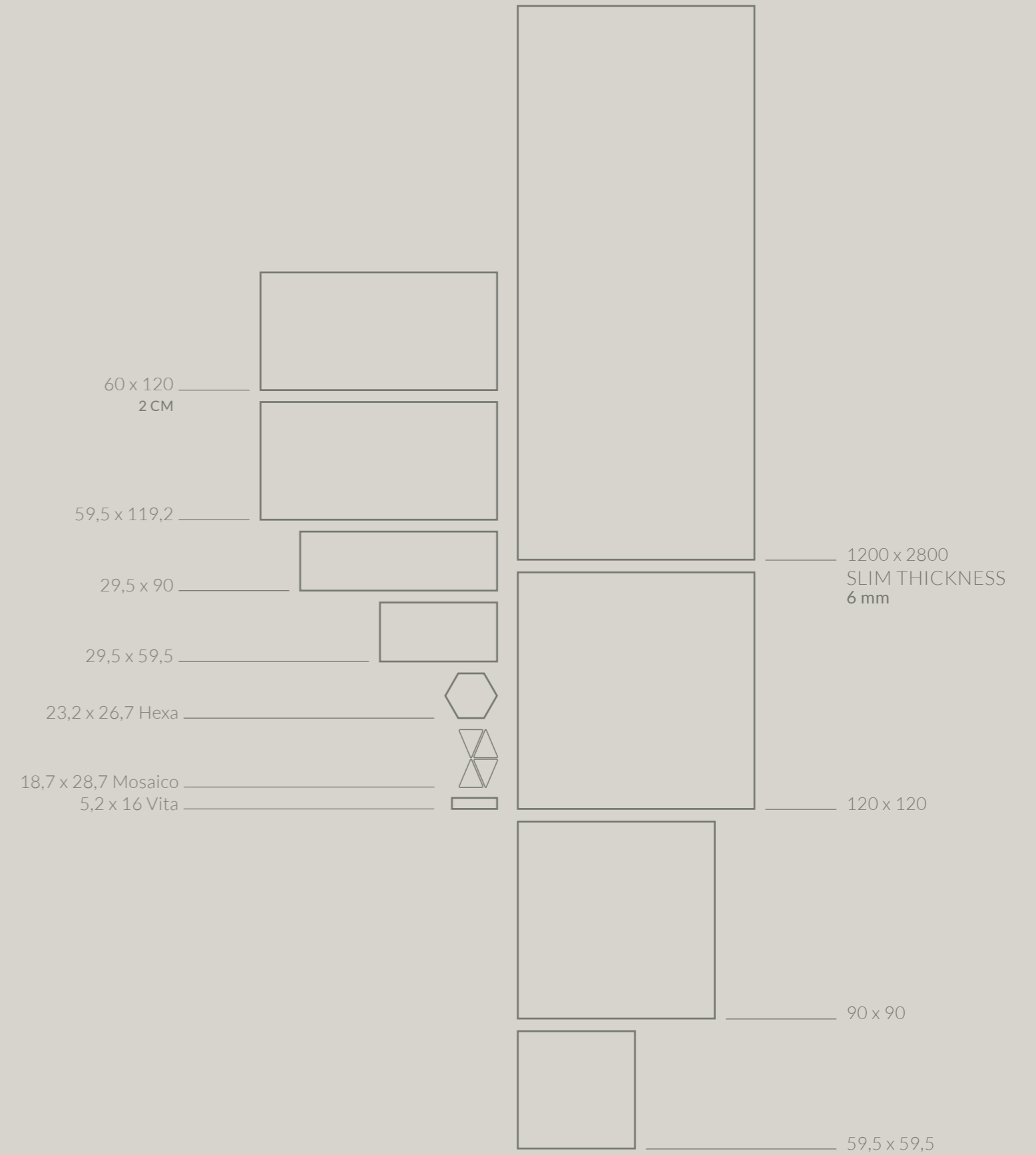

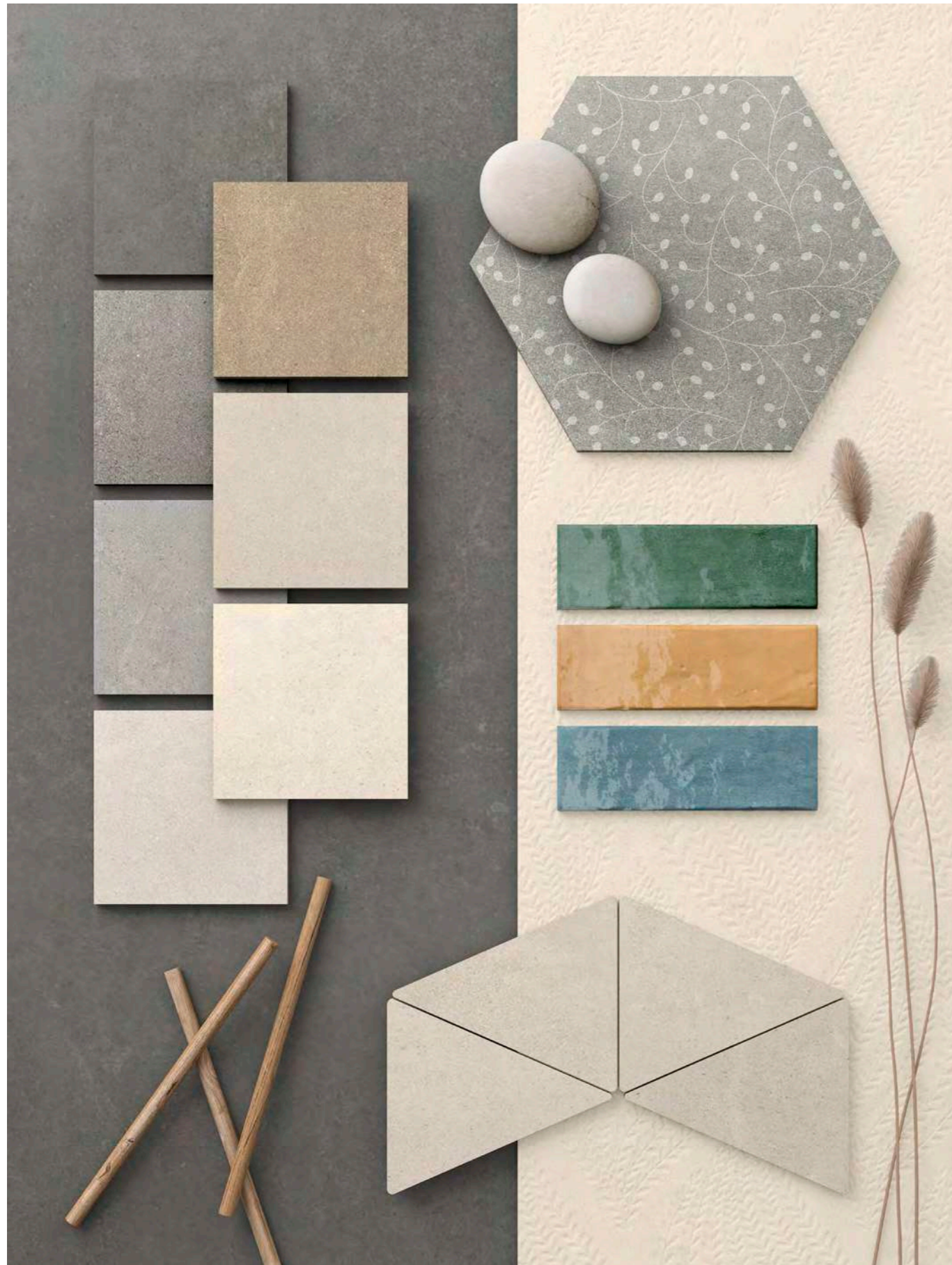

COLLECTION

LA COLECCIÓN

Seven is the new ceramic collection. Unprecedented. A subtle cement with a slightly irregular tone – perfect for calm, minimalist environments. Its uniqueness comes from its wide range of neutral colours with minimal contrast, originating from elements found in nature.

Seven es la nueva colección cerámica. Sin precedentes. Un cemento suave con ligera destonificación que es perfecta para ambientes calmados y minimalistas. Su singularidad radica en su amplia gama de colores neutros, sin apenas contraste, cuyo origen proviene de los elementos originarios de la naturaleza.

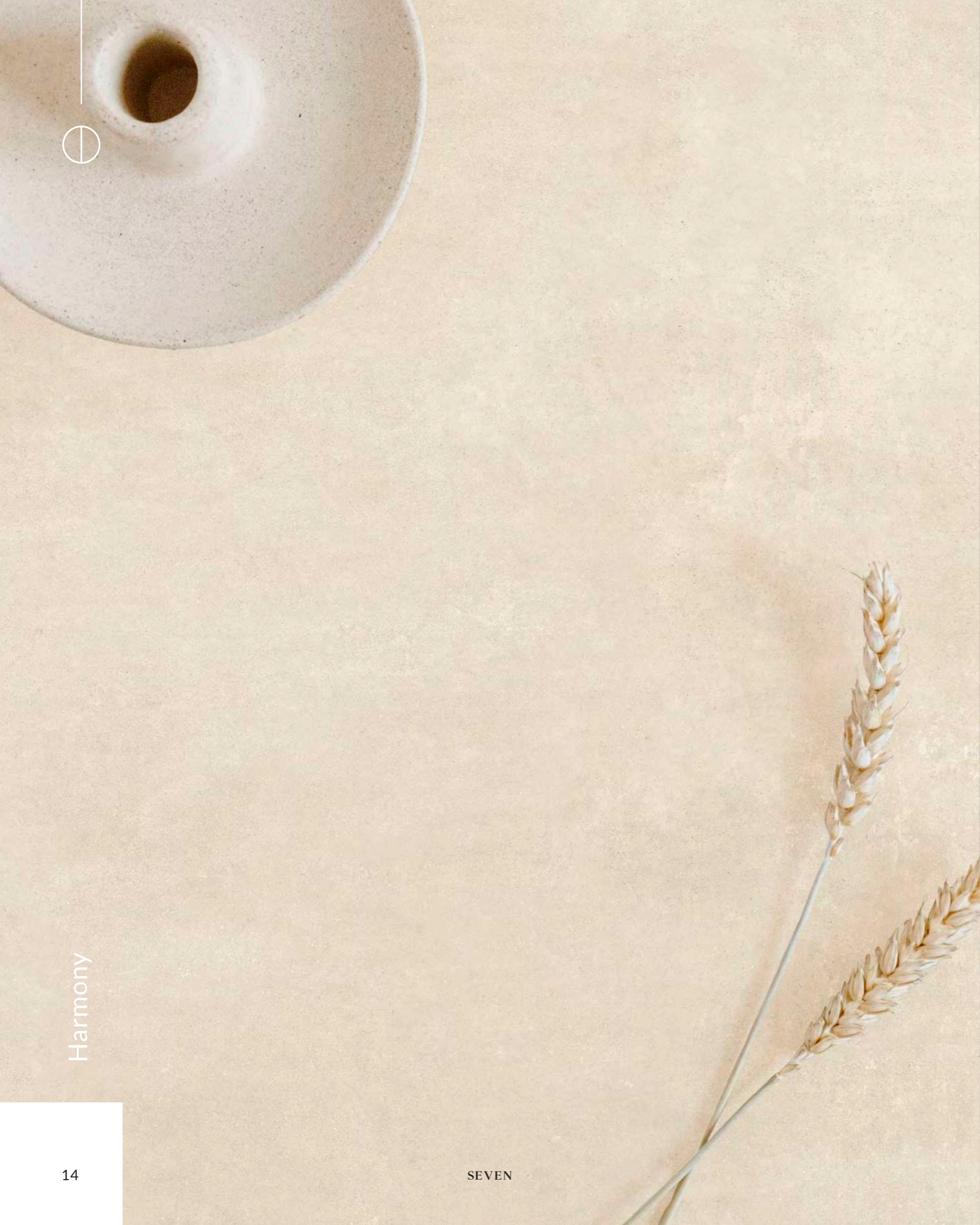

Beige

01 _____ 7

Security is a basic human need. Beige adopts the firm hold of roots clinging to the earth to provide a sense of balance, stability. Of living serenely, in harmony, treading on firm ground.

La seguridad es una de las necesidades básicas del ser humano. Beige toma el arraigo con el que se aferran las raíces a la tierra para aportar sensación de equilibrio, de estabilidad. De vivir tranquilos, en armonía, pisando sobre seguro.

e a r t h

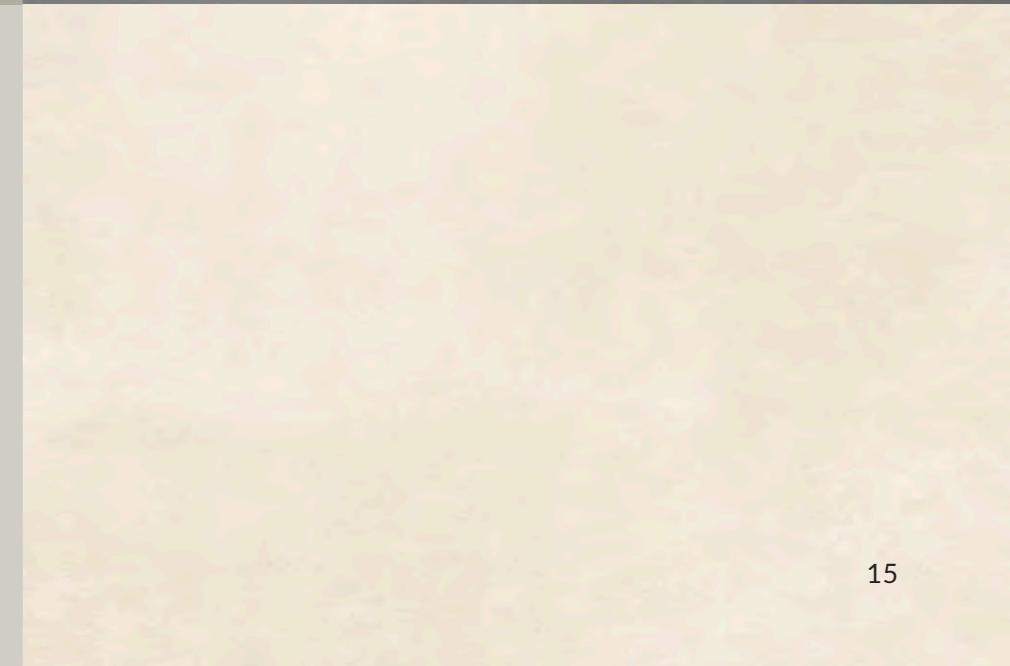



WALL&FLOOR: SEVEN BEIGE NATURAL 1200x2800 RECT.



WALL: SEVEN HAZELNUT NATURAL 1200x2800 RECT.
FLOOR: SEVEN BEIGE MATT 120x120 RECT.



WALL : SEVEN BEIGE DECOR MATT 29,5X90 RECT. · SEVEN BEIGE MATT 29,5X90 RECT.
FURNITURE : ATLANTIS SILK 1200X3000 RECT.

SEVEN

- BEIGE -

SEVEN

Beige

ARK
LAM

Slim Thickness
6 mm



Seven Beige Natural 1200 x 2800 Rect.



Garland Beige Natural 1200 x 2800 Rect.



Botanical Warm Natural 1200 x 2800 Rect.

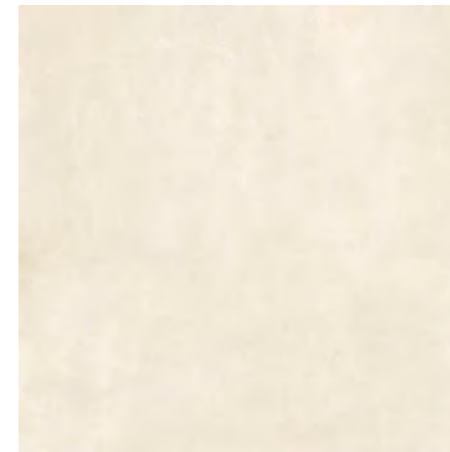

B47 Seven Beige Matt 120 x 120 Rect.



B85 Seven Beige Matt 59,5 x 119,2 Rect.

B88 Seven Beige Grip 59,5 x 119,2 Rect.

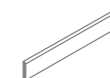

Skirting, Rodapié
P31 Beige 8 x 59,5 / 8 x 60



B69 Seven Beige Matt 29,5 x 90 Rect.



B59 Seven Beige Decor Matt 29,5 x 90 Rect.



B59 Evocative Warm Matt 29,5 x 90 Rect.



B27 Seven Beige Matt 29,5 x 59,5 Rect.

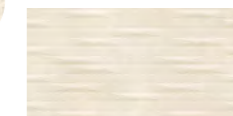

B118 Seven Beige Decor Matt 29,5 x 59,5 Rect.

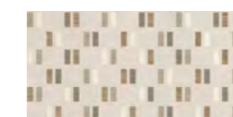

B118 Connection Warm Matt 29,5 x 59,5 Rect.



P136 Mosaico Seven Beige Matt 18,7x28,7



B68 Hexa Seven Warm Matt 23,2 x 26,7

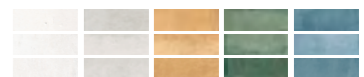

B121 Vita Shiny 5,2 x 16
5 colours - White, Pearl, Yellow, Green & Blue.

format · inches · different desings

- 1200 x 2800 · 47.2"x110" · 5
- 1200 x 2800 Botanical · 47.2"x110" · 2
- 120 x 120 · 48"x48" · 10
- 59,5 x 119,2 · 24"x48" · 20
- 29,5 x 90 · 12"x36" · 24
- 29,5 x 90 Evocative · 12"x36" · 3
- 29,5 x 59,5 · 12"x24" · 40
- 29,5 x 59,5 Connection · 12"x24" · 9
- 23,2 x 26,7 · 9"x10" · 24
- 18,7 x 28,7 · 7"x11" · -
- 5,2 x 16 · 2"x6" · 40
- 8 x 59,5 · 3"x24" · -
- 8 x 60 · 3"x24" · -



Sand

02 _____ 7

Human behaviour is conditioned by the desire to love. We love our families, those close to us, but we also love nature for everything it gives us while asking for nothing in return. Let's take care of the nature that inspires us and inspires our collections.

La actuación humana está condicionada por su deseo de amar. Amamos a nuestra familia, a los nuestros, pero también amamos la naturaleza por todo lo que nos da sin solicitar nada a cambio. Cuidemos de la naturaleza que nos inspira e inspira nuestras colecciones.

a i r





WALL: SEVEN SAND NATURAL 1200x2800 RECT. · GARLAND SAND NATURAL 1200x2800 RECT.
FLOOR: SEVEN SAND NATURAL 1200x2800 RECT.



WALL: SEVEN SAND MATT 59,5x119,2 RECT. • VITA WHITE SHINY 5,2x16
FLOOR: SEVEN SAND MATT 59,5x119,2 RECT.



FLOOR: SEVEN SAND MATT 90x90 RECT. · SEVEN SAND GRIP 90x90 RECT.

SEVEN

S a n d

ARK
LAM

Slim Thickness
6 mm



Seven Sand Natural 1200 x 2800 Rect.



Garland Sand Natural 1200 x 2800 Rect.



Botanical Warm Natural 1200 x 2800 Rect.

ITT
CERAMIC
INNOVATING
TRENDS
SINCE 1914
SANICERAMIC GROUP

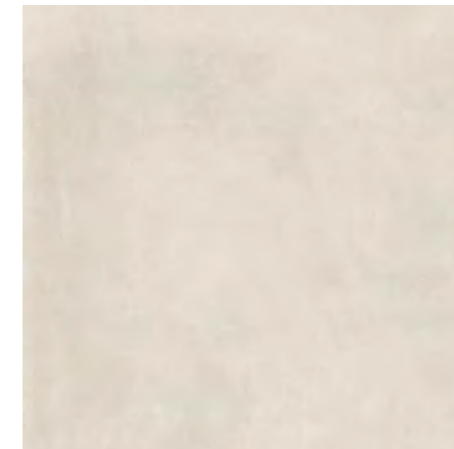

B47 Seven Sand Matt 120 x 120 Rect.

B53 Seven Sand Grip 120 x 120 Rect.

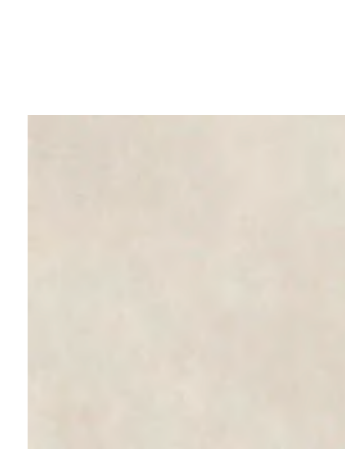

B70 Seven Sand Matt 90 x 90 Rect.

B122 Seven Sand Grip 90 x 90 Rect.



P136 Mosaico Seven Sand Matt 18,7x28,7

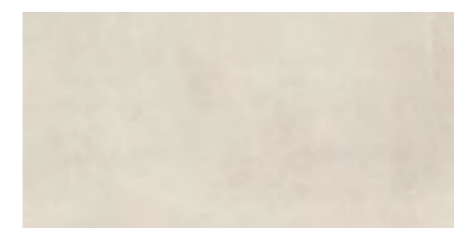

B85 Seven Sand Matt 29,5 x 90 Rect.

B88 Seven Sand Grip 29,5 x 90 Rect.

B120 Seven Sand Grip 60 x 120 Rect. 2CM

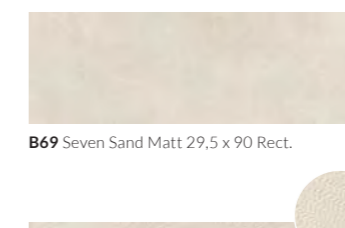

B69 Seven Sand Matt 29,5 x 90 Rect.

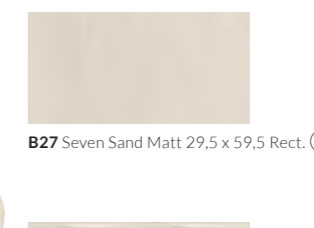

B27 Seven Sand Matt 29,5 x 59,5 Rect.



B59 Seven Sand Decor Matt 29,5 x 90 Rect.

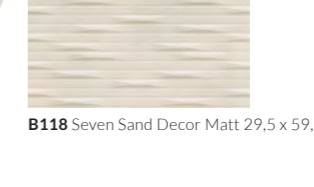

B118 Seven Sand Decor Matt 29,5 x 59,5 Rect.

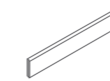

Skirting, Rodapié
P31 Sand 8 x 59,5 / 8 x 60
P36 Sand 8 x 90



B59 Evocative Warm Matt 29,5 x 90 Rect.



B118 Connection Warm Matt 29,5 x 59,5 Rect.

Creative
ESCLUSIVO



B68 Hexa Seven Warm Matt 23,2 x 26,7



B121 Vita Shiny 5,2 x 16
5 colours - White, Pearl, Yellow, Green & Blue.

format · inches · different desings
1200 x 2800 · 47,2"x110" · 5
1200 x 2800 Botanical · 47,2"x110" · 2
120 x 120 · 48"x48" · 10
90 x 90 · 36"x36" · 10
60 x 120 · 24"x48" · 20
59,5 x 119,2 · 24"x48" · 20
29,5 x 90 · 12"x36" · 24
29,5 x 90 Evocative · 12"x36" · 3
29,5 x 59,5 · 12"x24" · 40
29,5 x 59,5 Connection · 12"x24" · 9
23,2 x 26,7 · 9"x10" · 24
18,7 x 28,7 · 7"x11" · -
5,2 x 16 · 2"x6" · 40
8 x 59,5 · 3"x24" · -
8 x 60 · 3"x24" · -
8 x 90 · 3"x36" · -



Hazelnut

03 _____ 7

Fire is a natural element whose strength and power sweeps and transforms everything it touches. But fire is also about letting yourself be carried away by passion, by that overwhelming force that makes all aspirations come true. All that's needed is to focus on the goal. Success will arrive by its own means.

El fuego es un elemento natural cuya fuerza y poder arrasa y transforma todo lo que toca. Pero fuego también es dejarse llevar por la pasión, por esa fuerza arrebatadora que hace lograr todas las pretensiones. Solo hace falta poner el foco en el objetivo. Los éxitos vendrán solos.

f i r e





WALL: SEVEN HAZELNUT NATURAL 1200x2800 RECT. • CALACATTA PAONAZZO HOND 1200x3000 RECT. • VITA YELLOW SHINY 5,2x16
FLOOR: SEVEN HAZELNUT NATURAL 1200x2800 RECT.



WALL: SEVEN HAZELNUT MATT 59,5x119,2 RECT. - VITA BLUE SHINY 5,2x16
FLOOR: SEVEN HAZELNUT MATT 59,5x119,2 RECT.

SEVEN

H a z e l n u t

ARK
LAM

Slim Thickness
6 mm



Seven Hazelnut Natural 1200 x 2800 Rect.



Garland Hazelnut Natural 1200 x 2800 Rect.



Botanical Warm Natural 1200 x 2800 Rect.

ITT
CERAMIC
SANICERAMIC GROUP

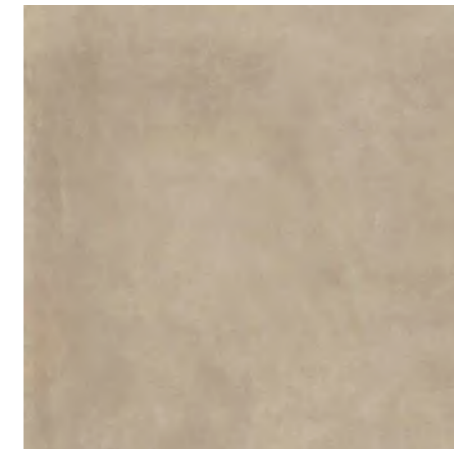

B47 Seven Hazelnut Matt 120 x 120 Rect. (C)

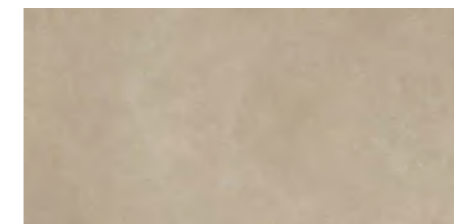

B85 Seven Hazelnut Matt 59,5 x 119,2 Rect. (C)

B88 Seven Hazelnut Grip 59,5 x 119,2 Rect. (C)

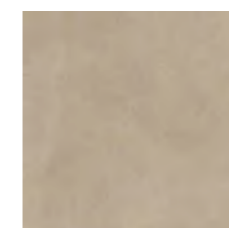

B27 Seven Hazelnut Matt 59,5 x 59,5 Rect. (C)

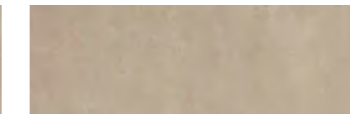

B69 Seven Hazelnut Matt 29,5 x 90 Rect.

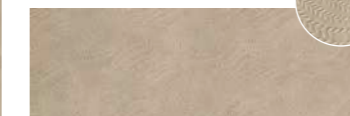

B59 Seven Hazelnut Decor Matt 29,5 x 90 Rect. (M)



B59 Evocative Warm Matt 29,5 x 90 Rect.



B27 Seven Hazelnut Matt 29,5 x 59,5 Rect. (C)



B118 Seven Hazelnut Decor Matt 29,5 x 59,5 Rect. (M, C)



B118 Connection Warm Matt 29,5 x 59,5 Rect. (C)



P136 Mosaico Seven Hazelnut Matt 18,7x28,7 (C)

Creative
COLLECTION



B68 Hexa Seven Warm Matt 23,2 x 26,7



B121 Vita Shiny 5,2 x 16
5 colours - White, Pearl, Yellow, Green & Blue.

format - inches - different desings

- 1200 x 2800 - 47,2"x110" - 5
- 1200 x 2800 Botanical - 47,2"x110" - 2
- 120 x 120 - 48"x48" - 10
- 59,5 x 59,5 - 24"x24" - 40
- 59,5 x 119,2 - 24"x48" - 20
- 29,5 x 90 - 12"x36" - 24
- 29,5 x 90 Evocative - 12"x36" - 3
- 29,5 x 59,5 - 12"x24" - 40
- 29,5 x 59,5 Connection - 12"x24" - 9
- 23,2 x 26,7 - 9"x10" - 24
- 18,7 x 28,7 - 7"x11" - -
- 5,2 x 16 - 2"x6" - 40
- 8 x 59,5 - 3"x24" - -
- 8 x 60 - 3"x24" - -



Skirting, Rodapié
P31 Hazelnut 8 x 59,5 / 8 x 60

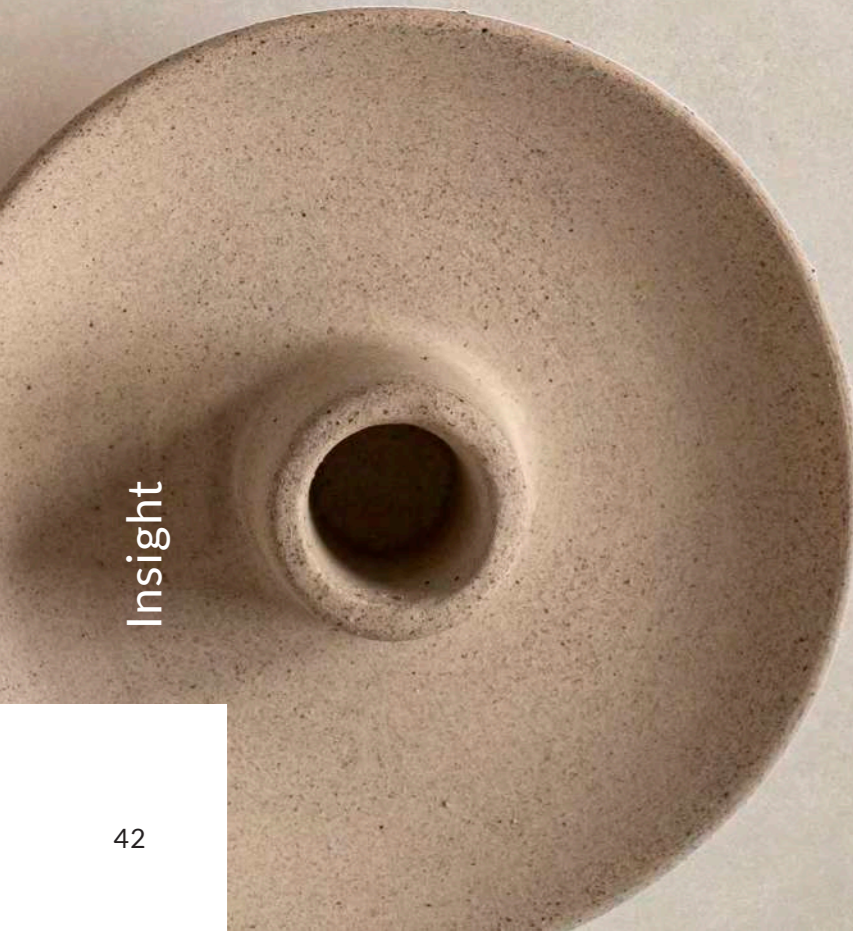

Insight

Pearl

04 _____ 7

Pearl represents the light that gives us a glimpse of the true picture, the path towards what is recommended, what is right, towards the best decision-making. And all this is translated, physically speaking, into the most serene and luminous environments.

Pearl representa la luz que nos permite ver la auténtica realidad, el camino hacia lo recomendado, lo correcto, hacia la mejor toma de decisiones. Y todo ello se traduce, matéricamente hablando, en ambientes de lo más serenos y luminosos.



l i g h t

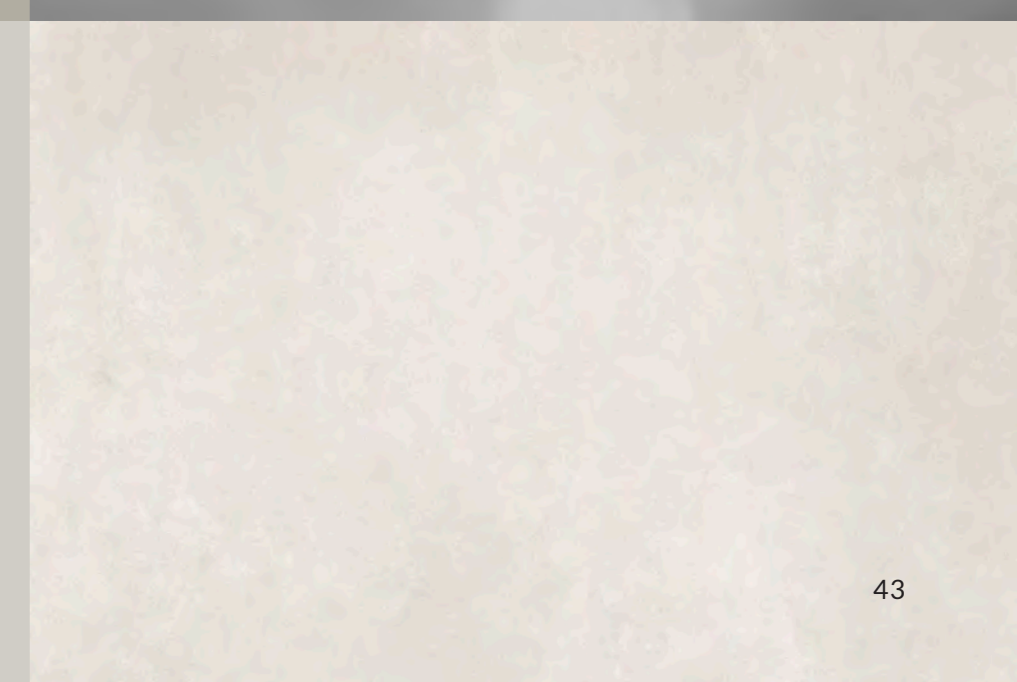



WALL: SEVEN PEARL NATURAL 1200x2800 RECT. - GARLAND PEARL NATURAL 1200x2800 RECT.
FLOOR: SEVEN PEARL NATURAL 1200x2800 RECT.



WALL: SEVEN DARK GREY DECOR MATT 29,5x59,5 RECT. · SEVEN DARK GREY MATT 59,5x119,2 RECT. · SEVEN PEARL MATT 59,5x119,2 RECT.
FLOOR: SEVEN PEARL MATT 120x120 RECT.



WALL: SEVEN PEARL MATT 29,5x90 RECT. - SEVEN PEARL DECOR MATT 29,5x90 RECT.
FLOOR: SEVEN GREY MATT 59,5x59,5 RECT.

SEVEN

Pearl

ARK
LAM

Slim Thickness
6 mm



Seven Pearl Natural 1200 x 2800 Rect.



Garland Pearl Natural 1200 x 2800 Rect.



Botanical Cold Natural 1200 x 2800 Rect.

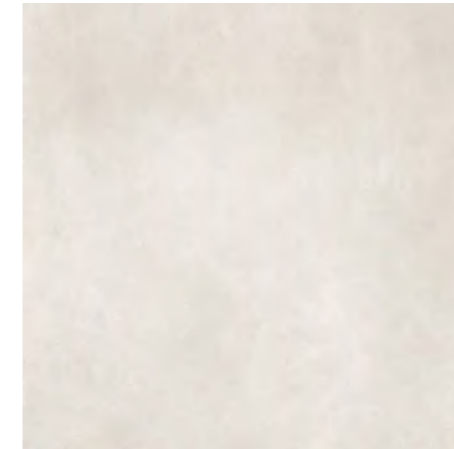

B47 Seven Pearl Matt 120 x 120 Rect.

B53 Seven Pearl Grip 120 x 120 Rect.

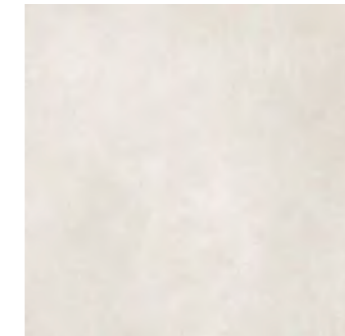

B70 Seven Pearl Matt 90 x 90 Rect.

B122 Seven Pearl Grip 90 x 90 Rect.



P136 Mosaico Seven Pearl Matt 18,7x28,7

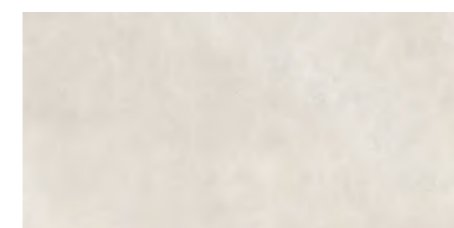

B85 Seven Pearl Matt 59,5 x 119,2 Rect.

B88 Seven Pearl Grip 59,5 x 119,2 Rect.

B120 Seven Pearl Grip 60 x 120 Rect. 2CM



B69 Seven Pearl Matt 29,5 x 90 Rect.

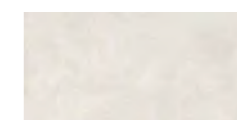

B27 Seven Pearl Matt 29,5 x 59,5 Rect.



B59 Seven Pearl Decor Matt 29,5 x 90 Rect.

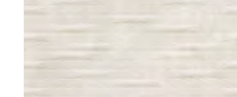

B118 Seven Pearl Decor Matt 29,5 x 59,5 Rect.



Skirting. Rodapié
P31 Pearl 8 x 59,5 / 8 x 60
P36 Pearl 8 x 90



B59 Evocative Cold Matt 29,5 x 90 Rect.



B118 Connection Cold Matt 29,5 x 59,5 Rect.

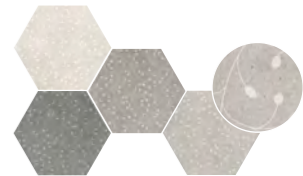
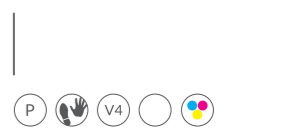

B68 Hexa Seven Cold Matt 23,2 x 26,7

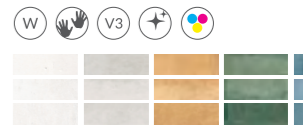

B121 Vita Shiny 5,2 x 16
5 colours - White, Pearl, Yellow, Green & Blue.

- format · inches · different desings**
- 1200 x 2800 · 47,2"x110" · 5
 - 1200 x 2800 Botanical · 47,2"x110" · 2
 - 120 x 120 · 48"x48" · 10
 - 90 x 90 · 36"x36" · 10
 - 60 x 120 · 24"x48" · 20
 - 59,5 x 119,2 · 24"x48" · 20
 - 29,5 x 90 · 12"x36" · 24
 - 29,5 x 90 Evocative · 12"x36" · 3
 - 29,5 x 59,5 · 12"x24" · 40
 - 29,5 x 59,5 Connection · 12"x24" · 9
 - 23,2 x 26,7 · 9"x10" · 24
 - 18,7 x 28,7 · 7"x11" · -
 - 5,2 x 16 · 2"x6" · 40
 - 8 x 59,5 · 3"x24" · -
 - 8 x 60 · 3"x24" · -
 - 8 x 90 · 3"x36" · -



Silver

05 _____ 7

Imagine the thrill of seeing something you've wanted to see for a long time. Or experiencing something amazing, living something for the first time. The sensation that gushes forth when contemplating incredible natural phenomena, like the sea. Silver precisely represents that – freshness, excitement, the malleability of an incomparable and unparalleled positive feeling.

Imagina la emoción de ver algo que llevabas mucho tiempo queriendo ver. O de experimentar algo sorprendente, de vivir algo por primera vez. La sensación que brota al contemplar fenómenos increíbles de la naturaleza, como el mar. Silver representa precisamente eso, frescura, ilusión, la maleabilidad de un sentimiento positivo incomparable e inigualable.

w a t e r





WALL: VITA PEARL SHINY 5,2x16 · BOTANICAL COLD NATURAL 1200x2800 RECT. · SEVEN SILVER NATURAL 1200x2800 RECT.
FLOOR: SEVEN SILVER NATURAL 1200x2800 RECT.



FLOOR: SEVEN SILVER MATT 120x120 RECT.

SEVEN

Silver

ARK
LAM

Slim Thickness
6 mm



Seven Silver Natural 1200 x 2800 Rect.



Garland Silver Natural 1200 x 2800 Rect.



Botanical Cold Natural 1200 x 2800 Rect.

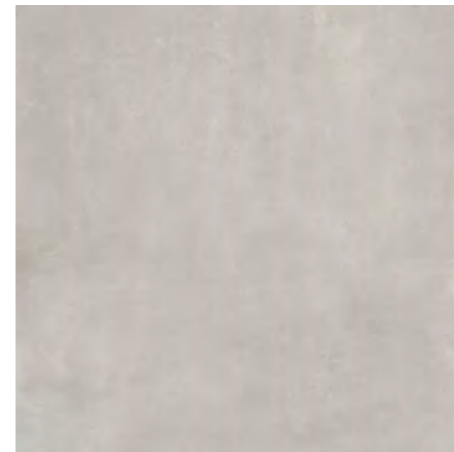

B47 Seven Silver Matt 120 x 120 Rect.

B53 Seven Silver Grip 120 x 120 Rect.

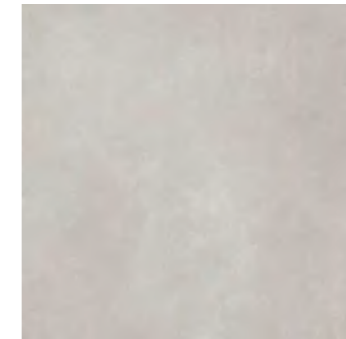

B70 Seven Silver Matt 90 x 90 Rect.

B122 Seven Silver Grip 90 x 90 Rect.



P136 Mosaico Seven Silver Matt 18,7x28,7

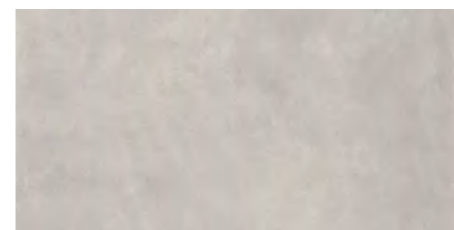

B85 Seven Silver Matt 59,5 x 119,2 Rect.

B88 Seven Silver Grip 59,5 x 119,2 Rect.

B120 Seven Silver Grip 60 x 120 Rect. 2CM



B69 Seven Silver Matt 29,5 x 90 Rect.

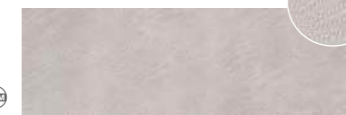

B59 Seven Silver Decor Matt 29,5 x 90 Rect.

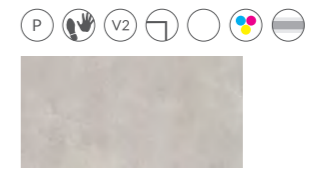

B27 Seven Silver Matt 29,5 x 59,5 Rect.

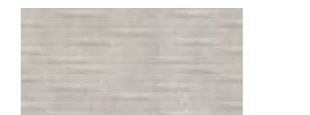

B118 Seven Silver Decor Matt 29,5 x 59,5 Rect.



B59 Evocative Cold Matt 29,5 x 90 Rect.



B118 Connection Cold Matt 29,5 x 59,5 Rect.

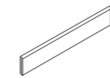

Skirting. Rodapié
P31 Silver 8 x 59,5 / 8 x 60
P36 Silver 8 x 90

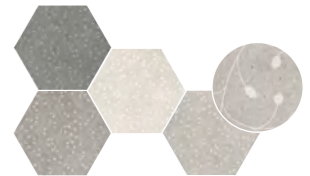

B68 Hexa Seven Cold Matt 23,2 x 26,7



B121 Vita Shiny 5,2 x 16
5 colours - White, Pearl, Yellow, Green & Blue.

format · inches · different desings

1200 x 2800 · 47,2"x110" · 5
1200 x 2800 Botanical · 47,2"x110" · 2
120 x 120 · 48"x48" · 10
90 x 90 · 36"x36" · 10
60 x 120 · 24"x48" · 20
59,5 x 119,2 · 24"x48" · 20
29,5 x 90 · 12"x36" · 24
29,5 x 90 Evocative · 12"x36" · 3
29,5 x 59,5 · 12"x24" · 40
29,5 x 59,5 Connection · 12"x24" · 9
23,2 x 26,7 · 9"x10" · 24
18,7 x 28,7 · 7"x11" · -
5,2 x 16 · 2"x6" · 40
8 x 59,5 · 3"x24" · -
8 x 60 · 3"x24" · -
8 x 90 · 3"x36" · -



Grey

06 _____ 7

Grey is the leitmotiv of the human, letting emotions take over, its connection to the perfect and inexplicable elements of nature through the seven symbols of Seven. Letting ourselves be carried away by our ideas and our dreams, awakening the imagination and fostering creativity to be truly happy and fulfilled.

Grey es el leitmotiv del ser humano dejándose llevar por las emociones, su conexión con lo perfecto e inexplicable de la naturaleza a través de los siete símbolos de Seven. Es dejarnos llevar por nuestras ideas y nuestros sueños, despertar la imaginación y fomentar la creatividad para ser realmente felices y plenos.

d r e a m s





WALL&FLOOR: SEVEN GREY NATURAL 1200x2800 RECT.



FLOOR: SEVEN GREY GRIP 90x90 RECT.



WALL: SEVEN GREY NATURAL 1200x2800 RECT. / VITA WHITE SHINY 5,2x16
FLOOR: SEVEN GREY GRIP 60x120 RECT. 2CM

SEVEN

Grey

ARK
LAM

Slim Thickness
6 mm

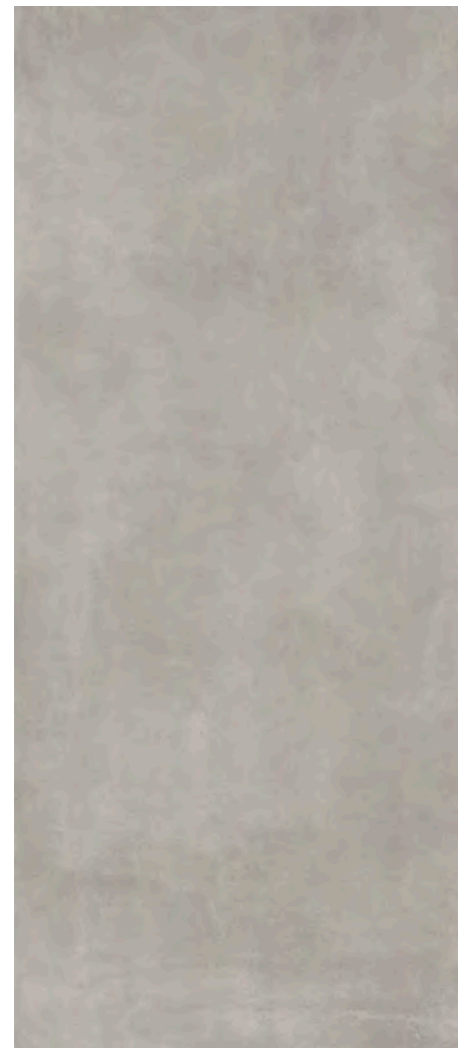

Seven Grey Natural 1200 x 2800 Rect.



Garland Grey Natural 1200 x 2800 Rect.



Botanical Cold Natural 1200 x 2800 Rect.

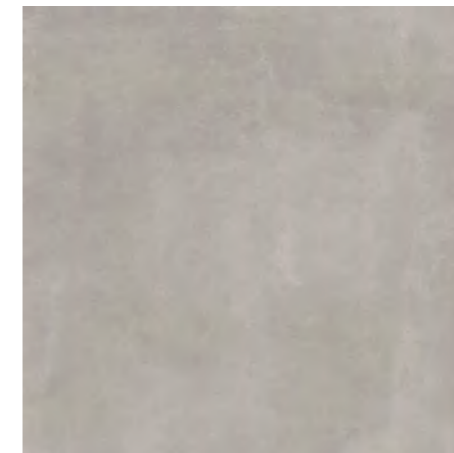

B47 Seven Grey Matt 120 x 120 Rect.

B53 Seven Grey Grip 120 x 120 Rect.

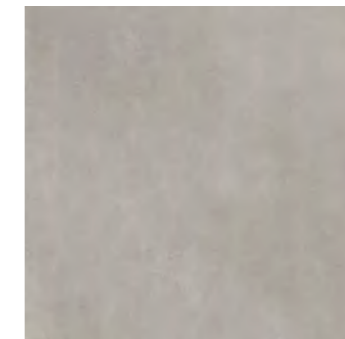

B70 Seven Grey Matt 90 x 90 Rect.

B122 Seven Grey Grip 90 x 90 Rect.

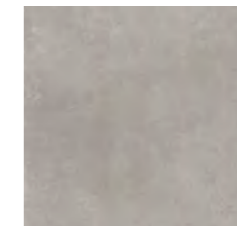

B27 Seven Grey Matt 59,5 x 59,5 Rect.



P136 Mosaico Seven Grey Matt 18,7x28,7

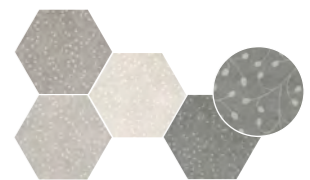

B68 Hexa Seven Cold Matt 23,2 x 26,7



B121 Vita Shiny 5,2x16
5 colours - White, Pearl, Yellow, Green & Blue.

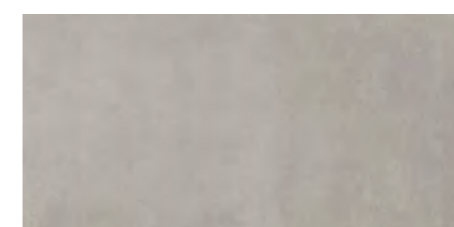

B85 Seven Grey Matt 59,5 x 119,2 Rect.

B88 Seven Grey Grip 59,5 x 119,2 Rect.

B120 Seven Grey Grip 60 x 120 Rect. 2CM

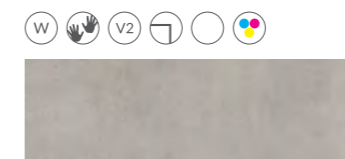

B69 Seven Grey Matt 29,5 x 90 Rect.

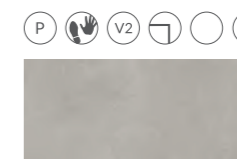

B27 Seven Grey Matt 29,5 x 59,5 Rect.



B59 Seven Grey Decor Matt 29,5 x 90 Rect.



B118 Seven Grey Decor Matt 29,5 x 59,5 Rect.



B59 Evocative Cold Matt 29,5 x 90 Rect.



B118 Connection Cold Matt 29,5 x 59,5 Rect.

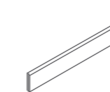

Skirting, Rodapié
P31 Grey 8 x 59,5 / 8 x 60
P36 Grey 8 x 90

format · inches · different desings
1200 x 2800 · 47,2"x110" · 5
1200 x 2800 Botanical · 47,2"x110" · 2
120 x 120 · 48"x48" · 10
90 x 90 · 36"x36" · 10
59,5 x 59,5 · 24"x24" · 40
60 x 120 · 24"x48" · 20
59,5 x 119,2 · 24"x48" · 20
29,5 x 90 · 12"x36" · 24
29,5 x 90 Evocative · 12"x36" · 3
29,5 x 59,5 · 12"x24" · 40
29,5 x 59,5 Connection · 12"x24" · 9
23,2 x 26,7 · 9"x10" · 24
18,7 x 28,7 · 7"x11" · -
5,2 x 16 · 2"x6" · 40
8 x 59,5 · 3"x24" · -
8 x 60 · 3"x24" · -
8 x 90 · 3"x36" · -

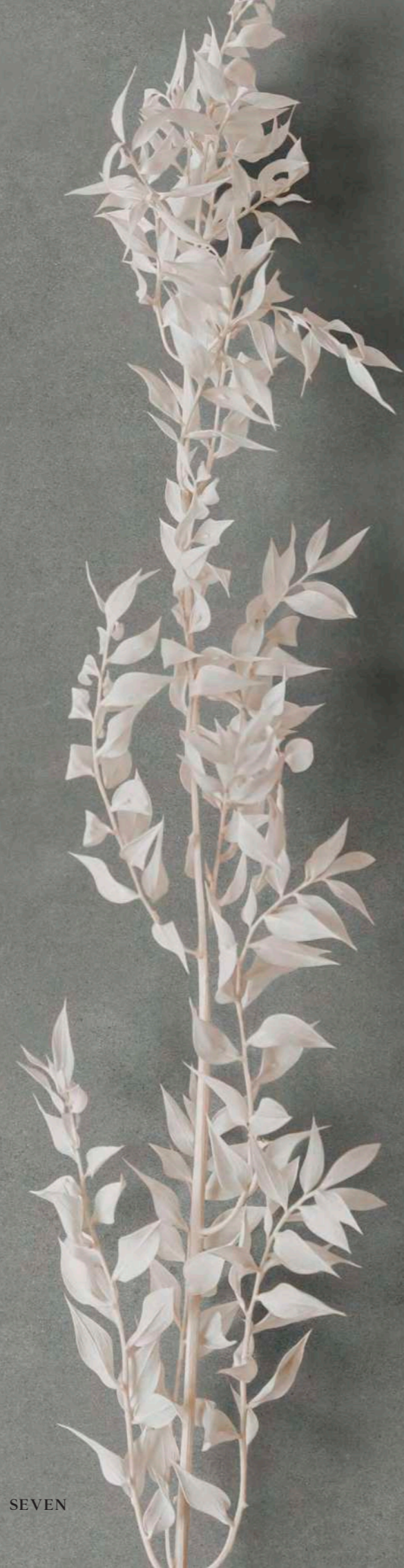

SEVEN

Dark Grey

07 _____ 7

Capacity to reflect and reason, to not follow instincts. Reflecting to shape decisions. Dark Grey is that "dark side" we all have, the reason that governs the body instead of letting emotions take over. Spirit. Fortitude. The conscience that guides us to the correct path.

Capacidad para reflexionar y razonar, no seguir instintos. Recapacitar para orientar las decisiones. Dark Grey es esa "parte oscura" que todos tenemos, la razón que rige el cuerpo frente a dejarse llevar por la emoción. El talante. El temple. La conciencia que nos guía hacia el camino correcto.

s o u n d





WALL: SEVEN DARK GREY NATURAL 1200x2800 RECT.
FLOOR: SEVEN DARK GREY NATURAL 1200x2800 RECT. · HEXA SEVEN COLD MATT 23,2x26,7 · IRATI OAK MATT 25x150 RECT.



WALL: VITA GREEN SHINY 5,2x16
FLOOR: SEVEN DARK GREY MATT 120x120 RECT.



WALL: SEVEN DARK GREY MATT 29,5x59,5 RECT. - SEVEN DARK GREY DECOR MATT 29,5x59,5 RECT.
FLOOR: SEVEN DARK GREY MATT 29,5x59,5 RECT.

SEVEN

Dark Grey

ARK
LAM

Slim Thickness
6 mm

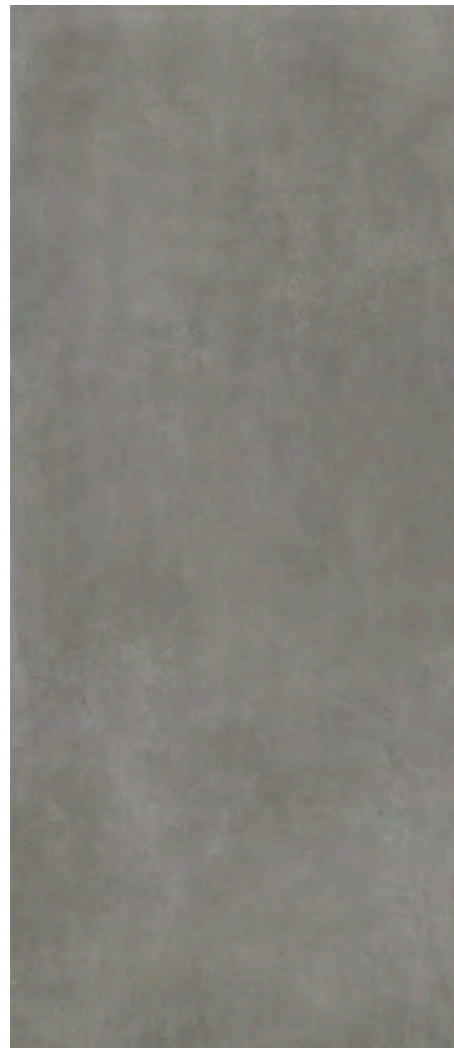

Seven Dark Grey Natural 1200 x 2800 Rect.

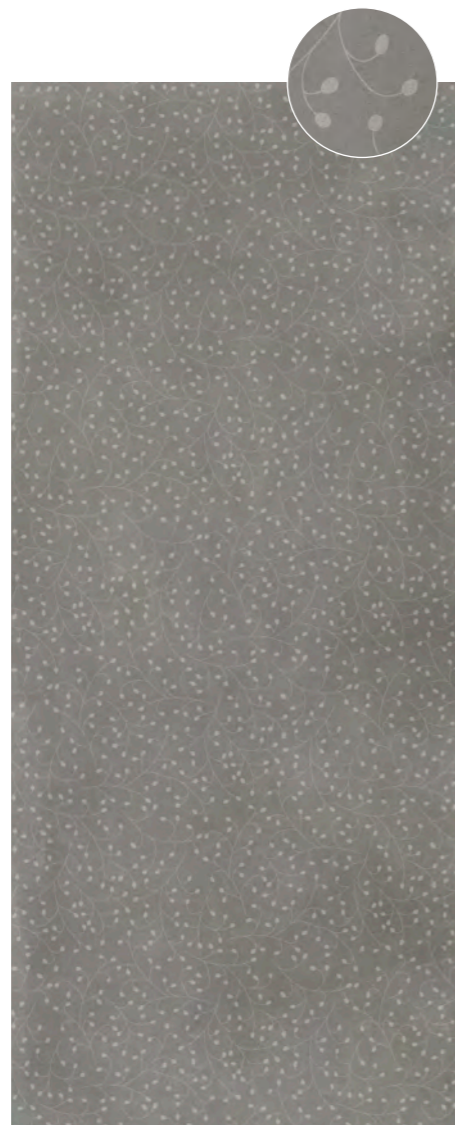

Garland Dark Grey Natural 1200 x 2800 Rect.



Botanical Cold Natural 1200 x 2800 Rect.



B47 Seven Dark Grey Matt 120 x 120 Rect.



B85 Seven Dark Grey Matt 59,5 x 119,2 Rect.

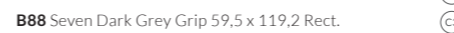

B88 Seven Dark Grey Grip 59,5 x 119,2 Rect.

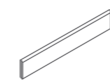

Skirting, Rodapié
P31 Dark Grey 8 x 59,5 / 8 x 60



B69 Seven Dark Grey Matt 29,5 x 90 Rect.



B59 Seven Dark Grey Decor Matt 29,5 x 90 Rect.



B59 Evocative Cold Matt 29,5 x 90 Rect.



B85 Seven Dark Grey Matt 59,5 x 119,2 Rect.



B88 Seven Dark Grey Grip 59,5 x 119,2 Rect.



B27 Seven Dark Grey Matt 29,5 x 59,5 Rect.

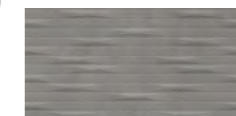

B118 Seven Dark Grey Decor Matt 29,5 x 59,5 Rect.

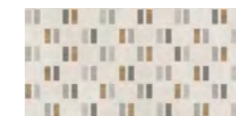

B118 Connection Cold Matt 29,5 x 59,5 Rect.



P136 Mosaico Seven Dark Grey Matt 18,7x28,7

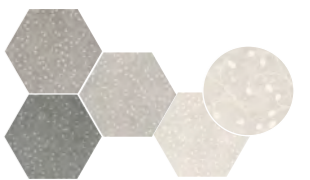

B68 Hexa Seven Cold Matt 23,2 x 26,7



B121 Vita Shiny 5,2 x 16
5 colours - White, Pearl, Yellow, Green & Blue.

format - inches - different desings

- 1200 x 2800 - 47,2"x110" - 5
- 1200 x 2800 Botanical - 47,2"x110" - 2
- 120 x 120 - 48"x48" - 10
- 59,5 x 119,2 - 24"x48" - 20
- 29,5 x 90 - 12"x36" - 24
- 29,5 x 90 Evocative - 12"x36" - 3
- 29,5 x 59,5 - 12"x24" - 40
- 29,5 x 59,5 Connection - 12"x24" - 9
- 23,2 x 26,7 - 9"x10" - 24
- 18,7 x 28,7 - 7"x11" - -
- 5,2 x 16 - 2"x6" - 40
- 8 x 59,5 - 3"x24" - -
- 8 x 60 - 3"x24" - -



DECORS & SPECIAL PIECES

DECORADOS Y PIEZAS ESPECIALES

Garland

1200 x 2800 mm · 47,2" x 110"

GARLAND IS AVAILABLE IN ALL COLOURS
GARLAND ESTÁ DISPONIBLE EN TODOS LOS COLORES

There are forms in nature worth imitating for their talent in triggering the senses. Seven concentrates on the sight-feel duo with a decor in the form of small branched flower petals. Combination of a soft tapestry and hand-painted, interweaving forms that attempt to compose new forms. Delicacy, calmness and serenity for designer spaces.

Existen formas de la naturaleza que vale la pena imitar por su talento para avivar los sentidos. Seven insta al tándem vista-tacto con un decorado que dibuja la forma de pequeños pétalos de flor ramificados. Combinación de un suave tapiz como pintado a mano, que entrelaza formas que intentan componer otras nuevas. Delicadeza, calma y serenidad para espacios de diseño.

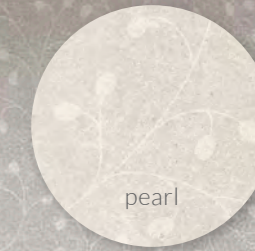

WALL: GARLAND SILVER NATURAL 1200x2800 RECT.



WALL: BOTANICAL WARM NATURAL 1200x2800 RECT.
 FLOOR: IRATI OAK MATT 25x150 RECT.

Botanical

1200 x 2800 mm · 47,2" x 110"

BOTANICAL DISPLACEMENT
 COLOCACIÓN BOTANICAL
 2 DESIGNS / 2 DISEÑOS



Inspired by the genuine beauty of nature, we create settings that awaken emotions. Botanical draws the outline of the flowers with an aesthetical proposal whose soft, delicate colours lend a sense of serenity and harmony to the space.

Nos inspiramos en la belleza genuina de la naturaleza para crear decorados que despierten emociones. Botanical dibuja la silueta de las flores en una propuesta estética cuyos colores suaves y delicados conceden serenidad y armonía al espacio.

Evocative

29,5 x 90 cm · 12" x 36"

EVOCATIVE IS AVAILABLE IN WARM AN COLD COLOURS
EVOCATIVE ESTÁ DISPONIBLE EN COLORES CÁLIDOS Y FRÍOS
3 DESIGNS / 3 DISEÑOS

Like observing the sea through a window. That's Evocative. A geometric relief composed of parallel lines of different thickness, simulating waves lapping the shore. A very handcrafted finish based on soft, neutral colours.

Como ver el mar desde una ventana. Así es Evocative. Un relieve geométrico compuesto de líneas paralelas de diferente grosor que simula olas adentrándose en la arena. Una solución de acabado muy artesanal y fundamentado en colores suaves y neutros.



EVOCATIVE WARM



EVOCATIVE COLD



WALL: EVOCATIVE WARM MATT 29,5x90 RECT. · SEVEN BEIGE MATT 29,5x90 RECT.
FLOOR: SEVEN HAZELNUT MATT 59,5x59,5 RECT.



WALL: CONNECTION WARM MATT 29,5x59,5 RECT. · SEVEN SAND MATT 29,5x59,5 RECT.
 FLOOR: IRATI OAK MATT 25x150 RECT.

Connection

29,5 x 59,5 cm · 12" x 24"

CONNECTION IS AVAILABLE IN WARM AND COLD COLOURS
 CONNECTION ESTÁ DISPONIBLE EN COLORES CÁLIDOS Y FRÍOS
 9 DESIGNS / 9 DISEÑOS



CONNECTION WARM



CONNECTION COLD

Broadening up the mind is also opening up to new ideas and combinations. Challenging the unknown. Placing the status quo in check. Seven explores new ways of making ceramics with a design that integrates small inlaid pieces of other materials into the stone base. Perfect symbiosis between cement, stone and wood.

Abrir la mente también es dar cabida a nuevas ideas y combinaciones. Desafiar lo conocido. Poner en jaque el Statu Quo. Seven explora nuevas formas de hacer cerámica con un decorado que integra en la misma base pétreo pequeñas incrustaciones ordenadas de otros materiales. Simbiosis perfecta entre cemento, piedra y madera.

Hexa Seven

23,2 x 26,7 cm · 9" x 10"

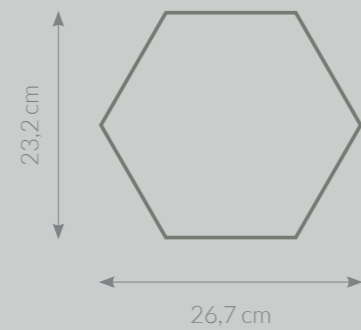

HEXA SEVEN IS AVAILABLE IN WARM AN COLD COLOURS
HEXA SEVEN ESTÁ DISPONIBLE EN COLORES CÁLIDOS Y FRÍOS
24 DESIGNS / 24 DISEÑOS

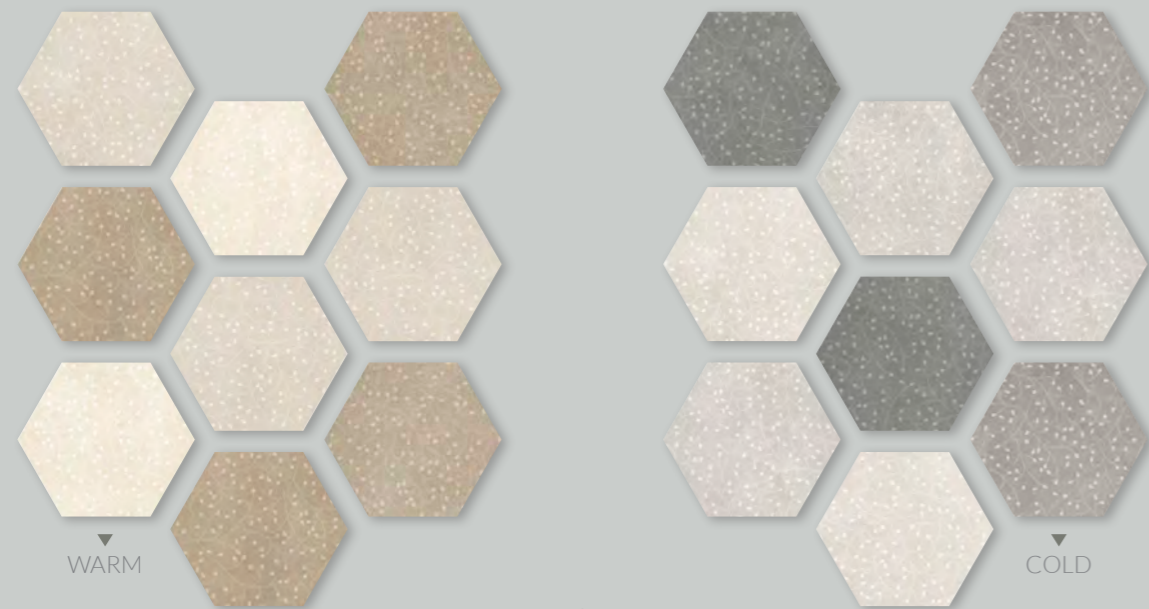

The hexagon is a perfect form found in nature. You only have to look closely at the environment to see its manifestations in places that govern the cycle of life, like in honeycombs or in some stony landscapes eroded by the force of the sea. Seven uses the hexagon to introduce the creative expression in the form of small pieces that combine the strength of nature with singleness of neutral colours. This is Hexa.

El hexágono es una forma perfecta de la naturaleza. Solo cabe divisar detenidamente nuestro entorno para ver sus manifestaciones en lugares que rigen el ciclo de la vida, como en los panales de las abejas o en algunos paisajes pétreos erosionados por la fuerza del mar. Seven toma el hexágono como forma para presentar la emoción decorativa en forma de pequeñas piezas que combinan la fuerza de la naturaleza con la sencillez de los colores neutros. Así es Hexa.



FLOOR: HEXA SEVEN WARM MATT 23,2x26,7



WALL: MOSAICO SEVEN BEIGE MATT 18,7x28,7

Mosaico Seven

18,7 x 28,7 cm · 7" x 11"

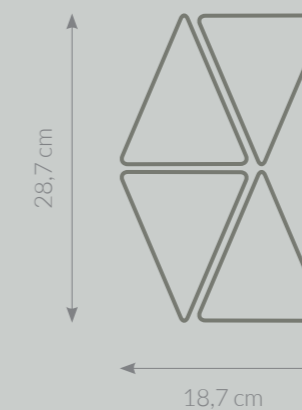

MOSAIC SEVEN IS AVAILABLE IN ALL COLOURS
MOSAICO SEVEN ESTÁ DISPONIBLE EN TODOS LOS COLORES



BEIGE SAND HAZELNUT PEARL SILVER GREY DARK GREY

Mathematical perfection wasn't invented by Man. It stems from the optimal mechanism through which each part of nature functions. We transfer this mathematical perfection to walls with a mosaic that expresses symmetry and balance a perfect design connection between the space and the environment.

Attention should be paid to the joints, which form geometrical shapes in themselves.

La perfección matemática no fue inventada por el hombre. Surge del mecanismo óptimo con el que funcionan cada una de las partes de la naturaleza. Llevamos esa perfección matemática a las paredes con un mosaico que expresa simetría y equilibrio, conexión decorativa perfecta con el espacio y el entorno.

Cabe prestar atención a las juntas, que forman figuras geométricas en sí mismas.

Vita

5,2 x 16 cm · 2" x 6"

40 DESIGNS / 40 DISEÑOS

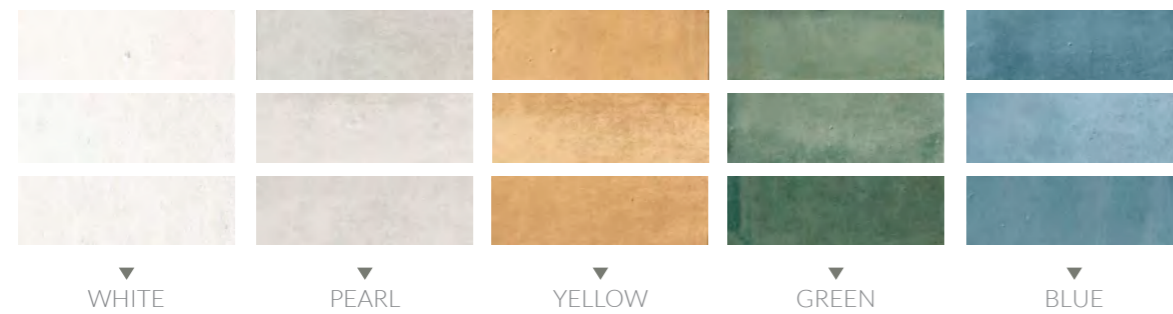

New colours. New ways of imagining and feeling nature. Vita breaks away from the tones of Seven with a cladding proposal that echoes the handcrafted zellige technique with a shiny, crystallised finish. Several placed rectangular pieces, reminiscent of craft techniques, with higher concentrations of pigment in some areas than in others.

Nuevos colores. Nuevas formas de imaginar y sentir la naturaleza. Vita se escapa de las tonalidades de Seven con una propuesta para revestimiento que rememora la técnica artesanal del zellige de apariencia brillante cristalizada. Piezas rectangulares para distintas colocaciones, rememorando las técnicas de creación artesanal, acumulan mayores concentraciones de pigmento en unas zonas que en otras.



WALL: VITA WHITE SHINY 5,2x16 · SEVEN HAZELNUT NATURAL 1200x2800 RECT.



SPECIFICATIONS

E S P E C I F I C A C I O N E S

SEVEN

Total Look



◀ THE 7 COLOURS

ARK
LAMI

Slim Thickness
6 mm

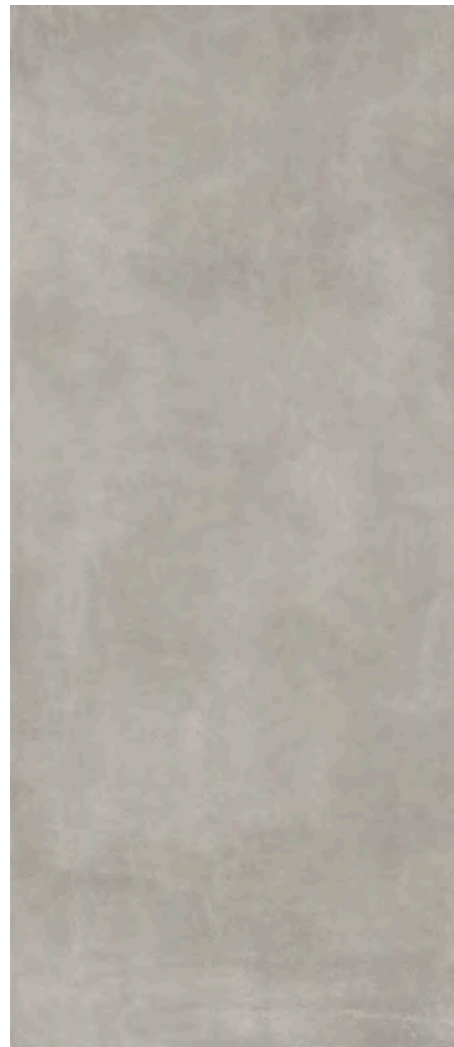

Seven Natural 1200 x 2800 Rect.
*Available in 7 colors / Disponible en 7 colores.



Garland Natural 1200 x 2800 Rect.
*Available in 7 colors / Disponible en 7 colores.
*Take a look to Garland in page 82 / Echa un vistazo a Garland en la página 82.



Botanical Cold Natural 1200 x 2800 Rect.
Botanical Warm Natural 1200 x 2800 Rect.
*Complet design in page 85 / Diseño completo en la página 85.

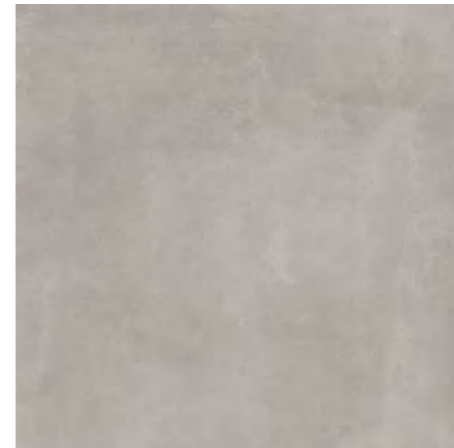

B47 Seven Matt 120 x 120 Rect.
*Available in 7 colors / Disponible en 7 colores.

B53 Seven Grip 120 x 120 Rect.
*Available in 7 colors / Disponible en 7 colores.

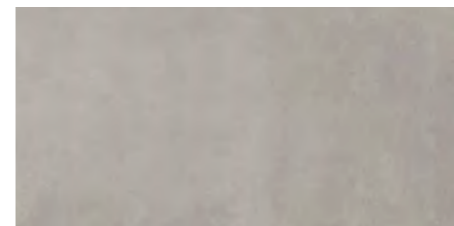

B85 Seven Matt 59,5 x 119,2 Rect.
*Available in 7 colors / Disponible en 7 colores.

B88 Seven Grip 59,5 x 119,2 Rect.
*Available in 7 colors / Disponible en 7 colores.

B120 Seven Grip 60 x 120 Rect. 2CM
*Available in 7 colors / Disponible en 7 colores.

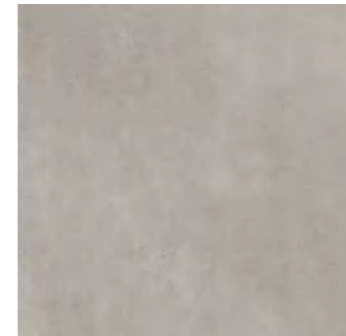

B70 Seven Matt 90 x 90 Rect.
*Available in 7 colors / Disponible en Pearl, Grey, Silver & Sand.

B122 Seven Grip 90 x 90 Rect.
*Available in 7 colors / Disponible en Pearl, Grey, Silver & Sand.

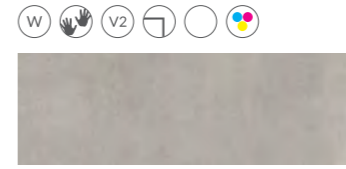

B69 Seven Matt 29,5 x 90 Rect.
*Available in 7 colors / Disponible en 7 colores.



B59 Seven Decor Matt 29,5 x 90 Rect.
*Available in 7 colors / Disponible en 7 colores.



B59 Evocative Cold Matt 29,5 x 90 Rect.
B59 Evocative Warm Matt 29,5 x 90 Rect.

*Take a look to Evocative in page 86 / Echa un vistazo a Evocative en la página 86.

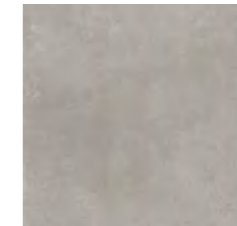

B27 Seven Matt 59,5 x 59,5 Rect.
*Available in 7 colors / Disponible en Grey & Hazelnut.



P136 Mosaico Seven Matt 18,7x28,7
*Available in 7 colors / Disponible en 7 colores.

*Take a look to Mosaico Seven in page 92 / Echa un vistazo a Mosaico Seven en la página 92.

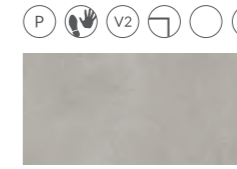

B27 Seven Matt 29,5 x 59,5 Rect.
*Available in 7 colors / Disponible en 7 colores.



B118 Seven Decor Matt 29,5 x 59,5 Rect.
*Available in 7 colors / Disponible en 7 colores.



B118 Connection Cold Matt 29,5 x 59,5 Rect.
B118 Connection Warm Matt 29,5 x 59,5 Rect.

*Take a look to Connection in page 88 / Echa un vistazo a Connection en la página 88.

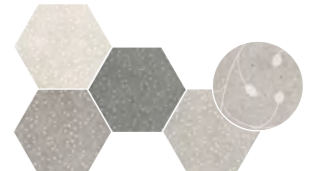

B68 Hexa Seven Cold Matt 23,2 x 26,7
B68 Hexa Seven Warm Matt 23,2 x 26,7

*Take a look to Hexa Seven in page 90 / Echa un vistazo a Hexa Seven en la página 90.

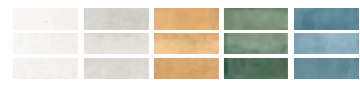

B121 Vita Shiny 5,2 x 16
5 colours - White, Pearl, Yellow, Green & Blue.

*Take a look to Vita in page 94 / Echa un vistazo a Vita en la página 94.

format · inches · different desings

- 1200 x 2800 · 47,2"x110" · 5
- 1200 x 2800 Botanical · 47,2"x110" · 2
- 120 x 120 · 48"x48" · 10
- 90 x 90 · 36"x36" · 10
- 59,5 x 59,5 · 24"x24" · 40
- 60 x 120 · 24"x48" · 20
- 59,5 x 119,2 · 24"x48" · 20
- 29,5 x 90 · 12"x36" · 24
- 29,5 x 90 Evocative · 12"x36" · 3
- 29,5 x 59,5 · 12"x24" · 40
- 29,5 x 59,5 Connection · 12"x24" · 9
- 23,2 x 26,7 · 9"x10" · 24
- 18,7 x 28,7 · 7"x11" · 1
- 5,2 x 16 · 2"x6" · 40
- 8 x 59,5 · 3"x24" · 1
- 8 x 60 · 3"x24" · 1
- 8 x 90 · 3"x36" · 1

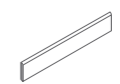

Skirting, Rodapié
P31 8 x 59,5 / 8 x 60
*Available in 7 colors / Disponible en 7 colores.

P36 8 x 90
*Available in 7 colors / Disponible en Pearl, Grey, Silver & Sand.

PACKING EMBALAJE

PIECES PIEZAS			
FORMAT FORMATO (mm)	TICKNESS ESPESOR	M2	KG
1200x2800 / 47,2" x 110"	6 MM	3,36	48,65

FRAME CABALLETE								
FORMAT FORMATO (mm)	THICKNESS ESPESOR (mm)	PIECES PIEZAS	M2	NET WEIGHT PESO NETO (Kg)	GROSS WEIGHT PESO BRUTO (Kg)	FRAME CABALLETE		
						HEIGHT ALTO	LENGHT LARGO	WIDHT ANCHO
1200x2800 / 47,2" x 110"	6 MM	44	147,84	2140,6	2262,1	1458	2900	750

FORMAT FORMATO (cm)	BOXES CAJAS			EUROPALLET EUROPALET		
	PIECES PIEZAS	M2	GROSS WEIGHT PESO BRUTO (Kg)	BOXES CAJAS	M2	GROSS WEIGHT PESO BRUTO (Kg)

PORCELAIN PORCELÁNICO						
120x120 / 48" x 48"	1	1,44	36,5	36	51,84	1349
90x90 / 36" x 36"	2	1,62	32,5	32	51,84	1100
60x120 (2 CM) / 24" x 28"	1	0,72	33,90	32	23,04	1100
59,5x119,2 / 24" x 28"	2	1,42	33	32	45,44	913
59,5x59,5 / 24" x 24"	4	1,42	26	36	51,12	959
29,5x59,5 / 12" x 24"	7	1,23	25	40	49,2	946
23,2x26,7 Hexa / 9" x 10"	16	0,75	14,5	90	67,5	1310
18,7x28,7 Mosaico / 7" x 11"	6	0,23	4,32	60	13,7	271,4

WHITE BODY PASTA BLANCA						
29,5x90 / 12" x 36"	6	1,59	25,1	54	85,86	1382,9
5,2x16 Vita / 2" x 6"	85	0,71	9,01	100	71,2	921

SYMBOLS SIMBOLOGÍA

 ARKLAM SINTERED MASS MASA SINTERIZADA ARKLAM	 DIGITAL TECHNOLOGY TECNOLOGÍA DIGITAL
 PORCELAIN PORCELÁNICO	 COLOURED BODY MASA COLOREADA
 WHITE BODY TILES PASTA BLANCA	 IN & OUT INTERIOR Y EXTERIOR
 MATT MATE	 GRIP ANTIDESLIZANTE
 SHINY BRILLO	 UNIFORM APPEARANCE APARIENCIA UNIFORME
 FLOOR TILE PAVIMENTO	 SLIGHT VARIATION LIGERA VARIACIÓN
 WALL TILE REVESTIMIENTO	 MODERATE DEGREE OF VARIATION VARIACIÓN MODERADA
 FLOOR AND WALL TILE PAVIMENTO Y REVESTIMIENTO	 HIGH DEGREE OF VARIATION VARIACIÓN SUSTANCIAL
 RELIEF RELIEVE	 RESISTENCIA A LA HELADA FROST RESISTANT
 RECTIFIED RECTIFICADO	 THICKNESS 20 MM ESPESOR 20 MM

GROUTS REJUNTES

COLLECTION COLECCIÓN	RECOMMENDED GROUT REJUNTE RECOMENDADO	
	Kerakoll	Mapei
SEVEN	BEIGE	Fugabella Eco 03 Gris Perla / Ultracolor Plus 133
	SAND	Fugabella Eco 03 Gris Perla / Ultracolor Plus 133
	HAZELNUT	Fugabella Eco 03 Gris Perla / Ultracolor Plus 133
	PEARL	Fugabella Eco 02 Gris Luz / Ultracolor Plus 103
	SILVER	Fugabella Eco 04 Gris Hierro / Ultracolor Plus 112
	GREY	Fugabella Eco 05 Antracita / Ultracolor Plus 133
	DARK GREY	Fugabella Eco 05 Antracita / Ultracolor Plus 133

TECHNICAL CHARACTERISTICS CARACTERÍSTICAS TÉCNICAS

SLIM THICKNESS / 6 MM

	TECHNICAL CHARACTERISTICS CARACTERÍSTICAS TÉCNICAS SEGÚN NORMAS	REFERENCE STANDARD NORMA DE REFERENCIA	VALUE REQUIRED VALOR REQUERIDO	MEAN VALUE VALOR MEDIO OBTENIDO
DIMENSIONAL CHARACTERISTICS Permissible deviation from work size.	Length and width Longitud y anchura		± 0,6 % / ± 2,0 mm	± 0,6 % / ± 2,0 mm
	Thickness Grosor		± 5 % / ± 0,5 mm	± 5 % / ± 0,5 mm
	Warpages of edges Rectitud de los lados	EN-ISO 10545-2	± 0,5 % / ± 1,5 mm	± 0,5 % / ± 1,5 mm
	Wedging Ortogonalidad		± 0,5 mm / ± 2 mm	± 0,5 % / ± 2,0 mm
	Flatness Planaridad		± 0,5 % / ± 2,0 mm	± 0,5 % / ± 2,0 mm
CHEMICAL CHARACTERISTICS CARACTERÍSTICAS QUÍMICAS	Resistance to household cleaning products and swimming pool additives Resistencia a productos domésticos de limpieza y aditivos de piscina.	EN-ISO 10545-13	GB Min. Mín. GB	Resist (GA) Resiste (GA)
	Resistance to acids and bases in low concentration Resistencia a ácidos y bases en baja concentración.	EN-ISO 10545-13	As indicated by manufacturer Indicada por el fabricante	Resist Matt (GLA) Resiste Matt (GLA) Resist Polished (GLB) Resiste Polished (GLB)
	Resistance to staining/ Resistencia a las manchas.	EN-ISO 10545-14	Class 3 min. Mín. Clase 3	Class 5 Clase 5

	TECHNICAL CHARACTERISTICS CARACTERÍSTICAS TÉCNICAS SEGÚN NORMAS	REFERENCE STANDARD NORMA DE REFERENCIA	VALUE REQUIRED VALOR REQUERIDO	MEAN VALUE VALOR MEDIO OBTENIDO
PHYSICAL CHARACTERISTICS CARACTERÍSTICAS FÍSICAS	Water absorption Absorción al agua	EN-ISO 10545-3	≤ 0,5 %	≤ 0,5 %
	Breaking strength Fuerza de rotura	EN-ISO 10545-4	≥ 700 N	Standard overtakes Supera la norma
	Bending strength Resistencia a la flexión	EN-ISO 10545-4	≥ 35 N / mm ²	Standard overtakes Supera la norma
	Resistance to deep abrasion Resistencia a la abrasión profunda	EN-ISO 10545-6	≤ 175 mm ³	Standard overtakes Supera la norma
	Resistance to abrasion utility - PEI Resistencia a la abrasión PEI	EN-ISO 10545-7	Indicate the result Indicar resultado	1 - 5
	Lineal thermal expansion Dilatación Térmica lineal	EN-ISO 10545-8	Indicate the result Indicar resultado	≤ 9 X 10 ⁻⁶ K ⁻¹
	Thermal shock resistance Resistencia al choque térmico	EN-ISO 10545-9	Pass test Superar prueba	Resist Resiste
	Mohs surface hardness Dureza Mohs	EN 101	Indicate the result Indicar resultado	4 - 8
	Frost resistance Resistencia a la helada	EN-ISO 10545-12	Pass test Superar prueba	Resist Resiste
	Fire resistance/ Resistencia al fuego	Decision 96/603/ CE Modified Decisión 96/603/ CE Modificada	A1	A1 _n
Resistencia al deslizamiento Anti-slip features	DIN 51130	-	-	

TECHNICAL CHARACTERISTICS CARACTERÍSTICAS TÉCNICAS

REST OF FORMATS RESTO DE FORMATOS

CHARACTERISTICS CARACTERÍSTICAS	ISO 13006 UNE-EN 14411	Bla 	BIII 
THICKNESS ESPESOR	EN ISO 10545-2	± 5 % ± 0,5 mm	± 10 % ± 0,5 mm
STRAIGHTNESS OF SIDES RECTITUD DE LADOS	EN ISO 10545-2	± 0,5 % ± 1,5 mm	± 0,5 %
RECTANGULARITY ORTOGONALIDAD	EN ISO 10545-2	± 0,5 % ± 2,0 mm	± 0,3 % ± 1,5 mm
SURFACE FLATNESS PLANITUD DE SUPERFICIE	EN ISO 10545-2	± 0,5 % ± 2,0 mm	+ 0,5 % ; - 0,3 % + 2 mm ; - 1,5 mm
WATER ABSORPTION ABSORCIÓN DE AGUA	EN ISO 10545-3	E ≤ 0,5 % Max. Individual 0,6%	E > 10 %
BREAKING STRENGTH * FUERZA DE ROTURA*	EN ISO 10545-4	E > 7,5 mm > 1300 N E < 7,5 mm > 700 N	E > 7,5 mm > 600 N E < 7,5 mm > 200 N
MODULUS OF RUPTURE (N/MM ²) RESISTENCIA A LA FLEXIÓN	EN ISO 10545-4	> 35 N/mm ² Min. Individual 35 N/mm ²	E > 7,5 > 12 N/mm ² E < 7,5 > 15 N/mm ²
SURFACE DEEP ABRASION RESISTANCE (ONLY UGL) RESISTENCIA A LA ABRASIÓN PROFUNDA (SOLO UGL)	EN ISO 10545-6	Min. 175 mm ³	Not apply No aplica
SURFACE ABRASION RESISTANCE (ONLY GL) RESISTENCIA A LA ABRASIÓN (SOLO GL)	EN ISO 10545-7	Declared value Valor declarado	Declared value Valor declarado
COEFFICIENT OF LINEAR THERMAL EXPANSION (1/K) COEFICIENTE DE DILATACIÓN TÉRMICA LINEAL	EN ISO 10545-8	Declared value Valor declarado	Declared value Valor declarado
THERMAL SHOCK RESISTANCE RESISTENCIA AL CHOQUE TÉRMICO	EN ISO 10545-9	Resist Resiste	Resist Resiste
CRAZING RESISTANCE RESISTENCIA AL CUARTEO	EN ISO 10545-11	Resist Resiste	Resist Resiste
FROST RESISTANCE RESISTENCIA A LA HELADA	EN ISO 10545-12	Resist Resiste	BIII Not Resist BIII No Resiste
COEFFICIENT OF FRICTION DESLIZAMIENTO	UNE ENV 41901 DIN 51130 DIN 51097 ANSI A137.1	Declared value Valor declarado	Declared value Valor declarado
RESISTANCE TO HOUSEHOLD CHEMICALS AND SWIMMING POOL SALTS RESISTENCIA A PRODUCTOS DE LIMPIEZA Y ADITIVOS PARA PISCINA	EN ISO 10545-4	Min GB	Min GB
RESISTANCE TO LOW CONCENTRATIONS RESISTENCIA A LAS BAJAS CONCENTRACIONES	EN ISO 10545-13	GLA - ULA / GLB (Polished) GLA - ULA / GLB (Pulido)	GLA
RESISTANCE TO HIGH CONCENTRATIONS RESISTENCIA A ALTAS CONCENTRACIONES	EN ISO 10545-13	GLA - ULA / GLB (Polished) GLA - ULA / GLB (Pulido)	GHA
RESISTANCE TO STAINS RESISTENCIA A LAS MANCHAS	EN ISO 10545-14	> 3	> 3

FORMAT FORMATO (cm)	FINISHED ACABADO	THICKNESS ESPESOR	TIPOLOGY TIPOLOGÍA	ANTI-SLIP FEATURES RESISTENCIA AL DESLIZAMIENTO	
				DIN 51130	UNE - ENV 12.633
120x120	Matt	10,2	Bla	R10	C2
120x120	Grip	10,2	Bla	R11	C3
90x90	Matt	10	Bla	R10	C2
90x90	Grip	10	Bla	R11	C3
59,5x119,2	Matt	9,2	Bla	R10	C2
59,5x119,2	Grip	9,2	Bla	R11	C3
60x120 (2CM.)	Grip	20	Bla	R11	C3
59,5x59,5	Matt	8,5	Bla	R10	C2
29,5x90	Matt	9,3	BIII	-	-
29,5x90 Decor	Matt	10,3	BIII	-	-
29,5x59,5	Matt	8,8	Bla	R10	C2
29,5x59,5 Decor	Matt	10,4	Bla	R10	C2
23,2x26,7 Hexa	Matt	8,7	Bla	-	-
18,7 x 28,7 Mosaico	Matt	8,8	Bla	R10	C2
5,2x16 Vita	Shiny	8,0	BIII	-	-

CERTIFICATIONS CERTIFICADOS



CE Marking declares conformity of our products with the technical and legal requirements for safety
 Marcado CE que declara la conformidad de todos nuestros productos con los requisitos legales y técnicos en materia de seguridad.



CCC Certificate that guarantees that our products meet the standard of radioactivity.
 Certificado CCC que avala que nuestros productos cumplen con el estándar de radioactividad.

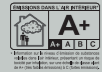

Certificate of content in COVs which states that our products are exempt and belong to type A.
 Certificado del contenido en COVs que declara que nuestros productos están exentos y son de tipo A.



LEED certificate that guarantees compliance with a set of rules on the use of strategies aimed at sustainability in buildings.
 Certificado LEED que avala el cumplimiento de un conjunto de normas sobre la utilización de estrategias encaminadas a la sostenibilidad en edificios.



AENOR certification, for implementing and maintaining a Quality Management System for the following scope: design, development, manufacture and marketing ceramic tiles that meet fulfills the requirements of the following standard ISO 9001:2015 Registrer Number: ER-0498/2020.
 Certificación de AENOR, para la aplicación y mantenimiento de un Sistema de Gestión de Calidad para el siguiente ámbito: diseñar, desarrollar, fabricar y comercializar baldosas cerámicas que cumplan los requisitos de Norma ISO 9001:2015 Número de registro: ER-0498/2020.



In compliance with UNE normative documents created in the Technical Committees for Standardization of the Spanish Association for Standardization and Certification.
 En cumplimiento con los documentos normativos UNE creados en los Comités Técnicos de Normalización de la Asociación Española de Normalización y Certificación.



DAPcons certification, EPD ecolabeling programme for pioneering construction in Spain which follows European guidelines and is regulated by ISO 14025 and 15804 standards.
 Certificación DAPcons, programa de ecoetiquetado de EPD de la construcción pionero en España que sigue las directrices europeas y regulado por las normas ISO 14025 y 15804.



Technical Approval Document - DIT
 Documento de Idoneidad Técnica - DIT.



The AAI includes all environmental aspects, and other related aspects considered by the competent environmental authorities, in accordance with basic state and corresponding autonomous legislation.
 La AAI incluye todos los aspectos ambientales, y aquellos otros relacionados que consideren las autoridades ambientales competentes, de acuerdo con la legislación básica estatal y las correspondientes autonómicas.



The quality and impartiality of the certification process, and the level of its requirements form the basis of the technical added value of QB certification.
 La calidad e imparcialidad del proceso de certificación y el nivel de sus requisitos constituyen la base del valor añadido técnico de la certificación QB.



NSF certification assures suppliers, retailers, regulators and consumers that an independent organisation has reviewed the manufacturing process and determined that the product meets specific standards of safety, quality, sustainability or performance.
 La certificación de NSF asegura a los proveedores, minoristas, entes reguladores y consumidores que una organización independiente ha revisado el proceso de fabricación y ha determinado que el producto cumple con estándares específicos de seguridad, calidad, sostenibilidad o desempeño.



A permit, issued by SASO, to use the Quality Mark on products, which verifies that the facility has an effective management system that ensures production conformity with the General Technical Regulation, granting procedure and Saudi standard specification.
 Permiso, expedido por SASO, para utilizar la marca de calidad en los productos, que verifica que la instalación dispone de un sistema de gestión eficaz que garantiza la conformidad de la producción con el Reglamento Técnico General, el procedimiento de concesión y la especificación de la norma saudí.

AWARDS DISTINCIONES



PREMIO nan

arquitectura y construcción

AL MEJOR MATERIAL PARA PAVIMENTO Y REVESTIMIENTO

2018



2018



Cámara

PREMIO A LA EXPORTACIÓN PYME EXPORTADORA

2017

CDI CV COLEGIO DE DISEÑADORES DE INTERIOR C.VALENCIANA

EA D COLECTIVO DE EMPRESAS ASOCIADAS PARA EL DISEÑO

AMC Asociación de Mobiliario de Cocina

CTAA COLEGIO TERRITORIAL DE ARQUITECTOS DE ALICANTE

PLAZATIO

jtc

member of **archiproducts**
 the worldwide source for architecture & design products

archiproducts
 DESIGN SELECTION
 2018

Member **NKBA**
 NATIONAL KITCHEN+BATH ASSOCIATION



www.arklam.es · arklam@arklam.es · Tel.: 0034 964 913 171 · Fax.: 0034 964 657 426
www.ittceramic.com · ittspain@ittspain.com · Tel.: 0034 964 626 309 · Fax.: 0034 964 657 426
Ctra. de Alcora, Km. 7,5 · 12130 Sant Joan de Moró · Castellón (Spain)

Follow us! · ¡Síguenos!





**ARK
LAMI**
QUALITY DOESN'T FEAR TIME



SANICERAMIC GROUP

www.arklam.es · arklam@arklam.es · www.ittceramic.com · ittspain@ittspain.es
Tel.: 0034 964 913 171 · Fax.: 0034 964 657 426
Ctra. de Alcora, Km. 7,5 · 12130 Sant Joan de Moró · Castellón (Spain)