



STRESA | STRESA SUITE

EQB DESIGN



TABELLA PREZZI FINITURE pag. 98

INFO TECNICHE pag. 98

INDICE / INDEX pag. 100

LAVABO pag. 109

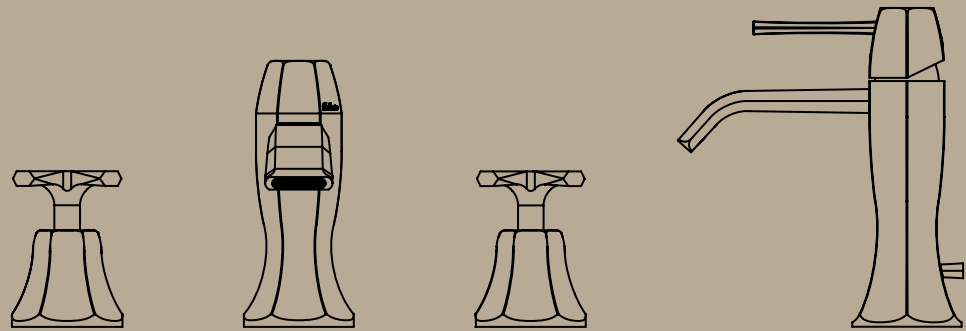
BIDET pag. 116

DOCCIA INCASSO pag. 117

DEVIATORI INCASSO pag. 120

DOCCIA ESTERNO pag. 122

VASCA pag. 123

BAGNO COMPLEMENTI pag. 126



STRESA
STRESA
SUITE

PREZZO FINITURE

Calcola il prezzo di listino (IVA esclusa) delle finiture diverse dal cromato, consultando la seguente tabella.

Moltiplicare il **PREZZO LISTINO** per il **COEFFICIENTE MOLTIPLICATORE** della finitura scelta, arrotondando per difetto il prezzo ottenuto (eliminare i centesimi).
ESEMPIO per ordinare art. 1405 in finitura dorato: codice **04-1405**

PRICE FINISHES

Include the list price (excluding VAT) of different finishes from chrome, consulting the following table. **Multiply the PRICE LIST MULTIPLIER COEFFICIENT** of the chosen finish, **reducing the price obtained by deleting the centesim.**

EXAMPLE to order art. 1405 gold finish: code **04-1405**

COMPOSIZIONE CODICE PER ORDINARE ARTICOLO IN FINITURA



CODICE FINITURA
FINISH CODE

CODICE ARTICOLO
ITEM NUMBER

FINITURE DI SERIE / STANDARD FINISHES

| CODICE CODE | DESCRIZIONE FINITURA FINISH DESCRIPTION | MOLTIPLICATORE MULTIPLIER |
|-------------|-----------------------------------------|---------------------------|
| 01- | cromato / chrome | PREZZO LISTINO* |
| 03- | oro/argento / gold/silver | x |
| 04- | dorato / gold | x |
| 05- | bronzo satinato / satin bronze | x |
| 06- | rame vecchio / old copper | x |
| 07- | vecchio argento / old silver | x |
| 12- | ottone lucido / polished brass | x |
| 13- | ottone naturale / natural brass | x |
| 19- | nero / black | x |
| 34- | cromo spazzolato / brushing chrome | x |
| 68- | rame opaco / mat copper | x |
| 69- | argento opaco / mat silver | x |
| 72- | bronzo opaco / mat bronze | x |

FINITURE A RICHIESTA / ON REQUEST FINISHES

| CODICE CODE | DESCRIZIONE FINITURA FINISH DESCRIPTION | MOLTIPLICATORE MULTIPLIER |
|-------------|-----------------------------------------|---------------------------|
| 11- | nero antracite / anthracite black | x |
| 14- | bianco / white | x |
| 28- | nickel satinato / satin nickel | x |
| 30- | nickel lucido / polished nickel | x |
| 33- | cromo satinato / satin chrome | x |
| 35- | nickel spazzolato / brushing nickel | x |
| 56- | avorio / ivory | x |
| 57- | azzurro / light blue | x |
| 58- | verdino / light green | x |
| 59- | marrone / brown | x |
| 60- | arancio / orange | x |
| 61- | rosso / red | x |
| 66- | bianco opaco / mat white | x |
| 67- | nero opaco / mat black | x |
| 71- | oro opaco / mat gold | x |
| 75- | dorato spazzolato / brushing gold | x |
| 87- | oro rosa / pink gold | x |
| 88- | ottone sisal / sisal brass | x |

FINITURE A RICHIESTA / ON REQUEST FINISHES

| CODICE CODE | DESCRIZIONE FINITURA FINISH DESCRIPTION | MOLTIPLICATORE MULTIPLIER |
|-------------|-----------------------------------------|---------------------------|
| 02- | cromo/oro / chrome/gold | x |
| 08- | canna di fucile / gun barrel | x |
| 10- | verderame / verdigris | x |

*PREZZO DI LISTINO / PRICE LIST

*NON REALIZZABILE / NOT MADE

ATTENZIONE! 13-OTTONE NATURALE e 88-OTTONE SISAL: finiture non protette che antichizzano naturalmente ossidando a contatto con l'umidità atmosferica.
WARNING! 13-NATURAL BRASS and 88-SISAL BRASS: unprotected finishes that naturally oxidise in contact with atmospheric humidity.

PROGETTO SU MISURA: RICHIESTE SPECIALI

I tecnici di Bellosta Rubinetterie sono, inoltre, a disposizione di architetti e designers, per offrire un servizio esclusivo: personalizzazioni di elementi in funzione di specifiche richieste estetiche o problematiche legate a vincoli progettuali, verifica della fattibilità attraverso opportuni studi CAD e sviluppo del disegno tecnico del prodotto speciale richiesto.

Per informazioni e richieste **PROGETTI SU MISURA:**
 ufficiotecnico@bellostarubinetterie.com



PROGETTO SU MISURA: SPECIAL REQUESTS

Engineers Bellosta Rubinetterie are also available to architects and designers, to offer an exclusive service: customizations of items according to specific aesthetic requirements or issues related to design constraints, verification of the feasibility studies and development through appropriate CAD technical design the required special product. For information and requests "SU MISURA" PROJECTS:
 ufficiotecnico@bellostarubinetterie.com

CONSIGLIO TECNICO

Tutti i miscelatori della collezione STRESA vengono collaudati nel loro funzionamento al momento dell'assemblaggio. Per garantire la durata delle cartucce nel tempo, si consiglia di spurgare bene l'impianto idraulico prima del montaggio (per rimuovere eventuali detriti) e di installare rubinetti sottolavabo con filtro (art. 020)

N.B.: Qualora il piano lavabo avesse uno spessore superiore a 4 cm specificare la misura al momento dell'ordine.

TECHNICAL ADVICE

All mixers of the STRESA collection are perfectly tested. To guarantee the perfect functionality of the cartridge for a long time, we advise to clean the sanitary plant before installing the mixer. Moreover we advise to install angle valve with filter (art. 020).

Attention: If the lavatory top is more than cm 4 thick, please point it out when placing the order.



FORATURA DEI PIANI SANITARI

I miscelatori lavabo/bidet monoforo prevedono un foro di diametro 35 mm nel piano sanitario. Le batterie lavabo 3 fori sono dotate di vitone ceramico destro con apertura a 1/4 di giro (90°); l'interasse consigliato è di 110 mm e foratura come da schema sottostante.

DRILLING PLANS HEALTH

The sink / hole bidet mixers provide a hole diameter of 35 mm in the health plan. The sink batteries 3 holes are equipped with ceramic cartridge Right-open 1/4 turn (90°); the recommended distance is 110 mm, drilling as per the diagram below.

MONOFORO >>

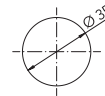

3 FORI >>

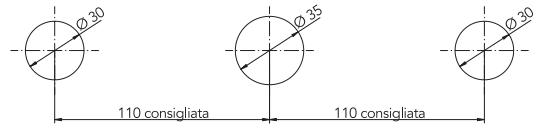

SCHEMA FUNZIONAMENTO DEVIATORI INCASSO 2/3/4 USCITE

Questi deviatori non hanno funzione di chiusura. Ruotando verso destra o sinistra si attivano le uscite. Tra 2 uscite adiacenti durante la rotazione diminuisce la portata dell'uscita iniziale ed incrementa quella della successiva. In posizione intermedia sono entrambe attive a pari portata.

SCHEME OPERATION SWITCHES FLUSH OUTPUT 2/3/4

These diverters have not closing function. By turning to the right or left activates the outputs. Between two adjacent outputs during the rotation decreases the initial output flow and increases that of the next. In position intermediate are both active at the same flow rate.

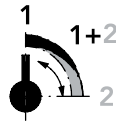

2 OUT

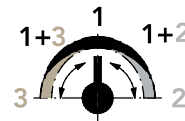

3 OUT

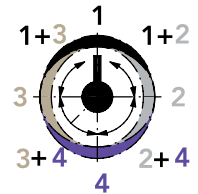

4 OUT

SCHEMA DI APERTURA MISCELATORE INCASSO CON MANIGLIA A CROCE
DIAGRAM FOR OPENING BUILT-IN MIXER WITH CROSS HANDLE

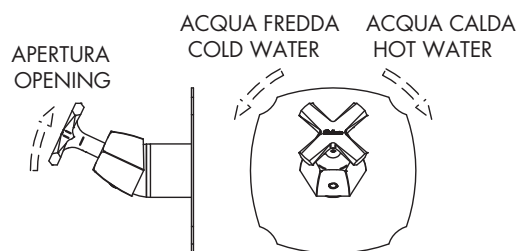

EROGAZIONE D'ACQUA

La collezione STRESA utilizza di serie erogazione con getto areato; la manutenzione avviene come da schema.

WATER SUPPLY

The collection STRESA is supplied by areated water jet, the maintenance is made like scheme.



STRESA
STRESA
SUITE

LEGENDA SIMBOLI

ACCESSORI
ACCESSORIES



SCARICO C/TAPPO A PRESSIONE

WASTE WITH PRESSURE CAP

RICAMBI IMMEDIATI
IMMEDIATE PARTS



CARTUCCIA CARTRIDGE



CARTUCCIA DEVIATRICE DIVERTER CARTRIDGE



CARTUCCIA TERMOSTATICA THERMOSTATIC CARTRIDGE



DEVIATORE DIVERTER



VITONE CERAMICO CERAMIC VALVE



AERATORE TONDO ROUND AERATOR



VITONE TRADIZIONALE TRADITIONAL VALVE



AERATORE PIATTO FLAT AERATOR

LAVABO

1705/4 pag. 109
 BATTERIA LAVABO TRE FORI
 3 HOLE BASIN



1805/4 | SUITE pag. 109
 BATTERIA LAVABO TRE FORI C/SWAROVSKI
 3 HOLE BASIN WITH SWAROVSKI



1705/4/S pag. 109
 BATTERIA LAVABO TRE FORI
 3 HOLE BASIN



1805/4/S | SUITE pag. 109
 BATTERIA LAVABO TRE FORI C/SWAROVSKI
 3 HOLE BASIN WITH SWAROVSKI



NEW **1705/4/A** pag. 109
 BATTERIA LAVABO MEDIUM TRE FORI
 3 HOLE "MEDIUM SIZE" BASIN



NEW **1805/4/A | SUITE** pag. 110
 BATTERIA LAVABO MEDIUM TRE FORI C/SWAROVSKI
 3 HOLE "MEDIUM SIZE" BASIN WITH SWAROVSKI



NEW **1705/4/A/S** pag. 110
 BATTERIA LAVABO MEDIUM TRE FORI
 3 HOLE "MEDIUM SIZE" BASIN



NEW **1805/4/A/S | SUITE** pag. 110
 BATTERIA LAVABO MEDIUM TRE FORI C/SWAROVSKI
 3 HOLE "MEDIUM SIZE" BASIN WITH SWAROVSKI



1705/2 pag. 110
 GRUPPO LAVABO MONOFORO
 ONE HOLE GROUP BASIN



1805/2 | SUITE pag. 110
 GRUPPO LAVABO MONOFORO C/SWAROVSKI
 ONE HOLE GROUP BASIN WITH SWAROVSKI



1705/2/S pag. 111
 GRUPPO LAVABO MONOFORO
 ONE HOLE GROUP BASIN



1805/2/S | SUITE pag. 111
 GRUPPO LAVABO MONOFORO C/SWAROVSKI
 ONE HOLE GROUP BASIN WITH SWAROVSKI



1405 pag. 111
 MISCELATORE LAVABO MONOFORO
 BASIN MIXER



1605 | SUITE pag. 111
 MISCELATORE LAVABO MONOFORO C/SWAROVSKI
 BASIN MIXER WITH SWAROVSKI



1405/S pag. 111
 MISCELATORE LAVABO MONOFORO
 BASIN MIXER



1605/S | SUITE pag. 112
 MISCELATORE LAVABO MONOFORO C/SWAROVSKI
 BASIN MIXER WITH SWAROVSKI





LAVABO

NEW **1405/P** pag. 112
 MISCELATORE LAVABO MEDIUM MONOFORO
 BOCCA PROLUNGATA
 BASIN MIXER EXTENDED SPOUT "MEDIUM SIZE"



NEW **1605/P | SUITE** pag. 112
 MISCELATORE LAVABO MEDIUM MONOFORO
 BOCCA PROLUNGATA C/SWAROVSKI
 BASIN MIXER EXTENDED SPOUT WITH SWAROVSKI
 "MEDIUM SIZE"



NEW **1405/P/S** pag. 112
 MISCELATORE LAVABO MEDIUM MONOFORO
 BOCCA PROLUNGATA
 BASIN MIXER EXTENDED SPOUT "MEDIUM SIZE"



NEW **1605/P/S | SUITE** pag. 112
 MISCELATORE LAVABO MEDIUM MONOFORO
 BOCCA PROLUNGATA C/SWAROVSKI
 BASIN MIXER EXTENDED SPOUT WITH SWAROVSKI
 "MEDIUM SIZE"



1405/2 pag. 113
 MISCELATORE LAVABO ALTO MONOFORO
 HIGHER BASIN MIXER



1605/2 | SUITE pag. 113
 MISCELATORE LAVABO ALTO MONOFORO
 C/SWAROVSKI
 HIGHER BASIN MIXER WITH SWAROVSKI



1405/1 pag. 113
 MISCELATORE LAVABO ALTO MONOFORO
 HIGHER BASIN MIXER



1605/1 | SUITE pag. 113
 MISCELATORE LAVABO ALTO MONOFORO
 C/SWAROVSKI
 HIGHER BASIN MIXER WITH SWAROVSKI



1705/3/E + 054061 pag. 113
 GRUPPO LAVABO DA PARETE
 WALL BASIN MOUNTED GROUP



parti esterne / external parts: 1705/3/E
 parte incasso / built-in part: 054061

1805/3/E + 054061 | SUITE pag. 114
 GRUPPO LAVABO DA PARETE C/SWAROVSKI
 WALL BASIN MOUNTED GROUP WITH SWAROVSKI



parti esterne / external parts: 1805/3/E
 parte incasso / built-in part: 054061

1705/3/1/E + 054061 pag. 114
 GRUPPO LAVABO DA PARETE BOCCA
 PROLUNGATA
 WALL BASIN MOUNTED GROUP EXTENDED SPOUT



parti esterne / external parts: 1705/3/1/E
 parte incasso / built-in part: 054061

1805/3/1/E + 054061 | SUITE pag. 114
 GRUPPO LAVABO DA PARETE BOCCA
 PROLUNGATA C/SWAROVSKI
 WALL BASIN MOUNTED GROUP EXTENDED SPOUT
 WITH SWAROVSKI



parti esterne / external parts: 1805/3/1/E
 parte incasso / built-in part: 054061

1405/3K/E + 894001 pag. 114
 MISCELATORE LAVABO DA PARETE SU PIASTRA
 WALL BASIN MIXER ON PLATE



parti esterne / external parts: 1405/3K/E
 parte incasso / built-in part: 894001

1605/3K/E + 894001 | SUITE pag. 114
 MISCELATORE LAVABO DA PARETE SU PIASTRA
 C/SWAROVSKI
 WALL BASIN MIXER ON PLATE WITH SWAROVSKI



parti esterne / external parts: 1605/3K/E
 parte incasso / built-in part: 894001

1405/3/1K/E + 894001 pag. 115
 MISCELATORE LAVABO DA PARETE BOCCA
 PROLUNGATA SU PIASTRA
 WALL BASIN MIXER EXTENDED SPOUT ON PLATE



parti esterne / external parts: 1405/3/1K/E
 parte incasso / built-in part: 894001

1605/3/1K/E + 894001 | SUITE pag. 115
 MISCELATORE LAVABO DA PARETE BOCCA
 PROLUNGATA SU PIASTRA C/SWAROVSKI
 WALL BASIN MIXER EXTENDED SPOUT ON PLATE
 WITH SWAROVSKI



parti esterne / external parts: 1605/3/1K/E
 parte incasso / built-in part: 894001



STRESA
 STRESA
 SUITE

LAVABO

1405/R/A pag. 115



MISCELATORE REMOTO
REMOTE MIXER

1605/R/A | SUITE pag. 115



MISCELATORE REMOTO C/SWAROVSKI
REMOTE MIXER WITH SWAROVSKI

1405/R/B/E + 104033 pag. 115



MISCELATORE INCASSO REMOTO
BUILT-IN REMOTE MIXER



parti esterne / external parts: 1405/R/B/E
parte incasso / built-in part: 104033

1605/R/B/E + 104033 | SUITE pag. 116



MISCELATORE INCASSO REMOTO C/SWAROVSKI
BUILT-IN REMOTE MIXER WITH SWAROVSKI



parti esterne / external parts: 1605/R/B/E
parte incasso / built-in part: 104033

144017 pag. 62

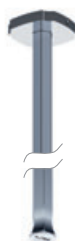

BOCCA A SOFFITTO STRESA
STRESA CEILING SPOUT

BIDET

1707/7 pag. 116



BATTERIA BIDET TRE FORI
3 HOLE BIDET

1807/7 | SUITE pag. 116



BATTERIA BIDET TRE FORI C/SWAROVSKI
3 HOLE BIDET WITH SWAROVSKI

1707/2 pag. 116



GRUPPO BIDET MONOFORO
ONE HOLE GRUOP BIDET

1807/2 | SUITE pag. 116



GRUPPO BIDET MONOFORO C/SWAROVSKI
ONE HOLE GRUOP BIDET WITH SWAROVSKI

1407 pag. 117



MISCELATORE BIDET MONOFORO
BIDET MIXER

1607 | SUITE pag. 117



MISCELATORE BIDET MONOFORO C/SWAROVSKI
BIDET MIXER WITH SWAROVSKI

DOCCIA INCASSO

1700/3/E + 054059 pag. 117



GRUPPO INCASSO C/DEVIATORE 2 USCITE
BUILT-IN GROUP WITH 2 OUT DIVERTER



parti esterne / external parts: 1700/3/E
parte incasso / built-in part: 054059

1800/3/E + 054059 | SUITE pag. 117



GRUPPO INCASSO C/DEVIATORE 2 USCITE
C/SWAROVSKI
BUILT-IN GROUP WITH 2 OUT DIVERTER WITH
SWAROVSKI



parti esterne / external parts: 1800/3/E
parte incasso / built-in part: 054059

1421/K/E + 104018 pag. 117



MISCELATORE INCASSO
BUILT-IN MIXER



parti esterne / external parts: 1421/K/E
parte incasso / built-in part: 104018

1621/K/E + 104018 | SUITE pag. 118



MISCELATORE INCASSO C/SWAROVSKI
BUILT-IN MIXER WITH SWAROVSKI



parti esterne / external parts: 1621/K/E
parte incasso / built-in part: 104018

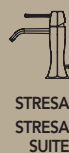

STRESA
STRESA
SUITE

DOCCIA INCASSO



1721/K/E + 104018 pag. 118

MISCELATORE INCASSO
BUILT-IN MIXER

parti esterne / external parts: 1721/K/E
parte incasso / built-in part: 104018



1821/K/E + 104018 | SUITE pag. 118

MISCELATORE INCASSO C/SWAROVSKI
BUILT-IN MIXER WITH SWAROVSKI

parti esterne / external parts: 1821/K/E
parte incasso / built-in part: 104018



1400/K/E + 104002 pag. 118

MISCELATORE INCASSO C/DEVIATORE 2 USCITE
BUILT-IN MIXER WITH DIVERTER 2 OUT

parti esterne / external parts: 1400/K/E
parte incasso / built-in part: 104002



1600/K/E + 104002 | SUITE pag. 118

MISCELATORE INCASSO C/DEVIATORE 2 USCITE
C/SWAROVSKI
BUILT-IN MIXER WITH DIVERTER 2 OUT WITH
SWAROVSKI

parti esterne / external parts: 1600/K/E
parte incasso / built-in part: 104002



1700/K/E + 104002 pag. 119

MISCELATORE INCASSO C/DEVIATORE 2 USCITE
BUILT-IN MIXER WITH DIVERTER 2 OUT

parti esterne / external parts: 1700/K/E
parte incasso / built-in part: 104002



1800/K/E + 104002 | SUITE pag. 119

MISCELATORE INCASSO C/DEVIATORE 2 USCITE
C/SWAROVSKI
BUILT-IN MIXER WITH DIVERTER 2 OUT WITH
SWAROVSKI

parti esterne / external parts: 1800/K/E
parte incasso / built-in part: 104002



1400/1K/E + 724027 pag. 119

MISCELATORE INCASSO C/DEVIATORE E DOCCINO
BUILT-IN MIXER WITH DIVERTER AND HAND
SHOWER

parti esterne / external parts: 1400/1K/E
parte incasso / built-in part: 724027



1600/1K/E + 724027 | SUITE pag. 119

MISCELATORE INCASSO C/DEVIATORE E DOCCINO
C/SWAROVSKI
BUILT-IN MIXER WITH DIVERTER AND HAND
SHOWER WITH SWAROVSKI

parti esterne / external parts: 1600/1K/E
parte incasso / built-in part: 724027



1700/1K/E + 724027 pag. 119

MISCELATORE INCASSO C/DEVIATORE E DOCCINO
BUILT-IN MIXER WITH DIVERTER AND HAND
SHOWER

parti esterne / external parts: 1700/1K/E
parte incasso / built-in part: 724027



1800/1K/E + 724027 | SUITE pag. 120

MISCELATORE INCASSO C/DEVIATORE E DOCCINO
C/SWAROVSKI
BUILT-IN MIXER WITH DIVERTER AND HAND
SHOWER WITH SWAROVSKI

parti esterne / external parts: 1800/1K/E
parte incasso / built-in part: 724027

DEVIATORI INCASSO



1403/2K/E + 914016 pag. 120

DEVIATORE INCASSO 2 USCITE
BUILT-IN DIVERTER 2 OUT

parti esterne / external parts: 1403/2K/E
parte incasso / built-in part: 914016



1603/2K/E + 914016 | SUITE pag. 120

DEVIATORE INCASSO 2 USCITE C/SWAROVSKI
BUILT-IN DIVERTER 2 OUT WITH SWAROVSKI

parti esterne / external parts: 1603/2K/E
parte incasso / built-in part: 914016



1703/2/E + 914016 pag. 120

DEVIATORE INCASSO 2 USCITE
BUILT-IN DIVERTER 2 OUT

parti esterne / external parts: 1703/2/E
parte incasso / built-in part: 914016



1803/2/E + 914016 | SUITE pag. 120

DEVIATORE INCASSO 2 USCITE C/SWAROVSKI
BUILT-IN DIVERTER 2 OUT WITH SWAROVSKI

parti esterne / external parts: 1803/2/E
parte incasso / built-in part: 914016



1403/3K/E + 034127 pag. 121

DEVIATORE INCASSO 3 USCITE
BUILT-IN DIVERTER 3 OUT

parti esterne / external parts: 1403/3K/E
parte incasso / built-in part: 034127



1603/3K/E + 034127 | SUITE pag. 121

DEVIATORE INCASSO 3 USCITE C/SWAROVSKI
BUILT-IN DIVERTER 3 OUT WITH SWAROVSKI

parti esterne / external parts: 1603/3K/E
parte incasso / built-in part: 034127





STRESA
STRESA
SUITE

DEVIATORI INCASSO

1703/3/E + 034127 pag. 121



DEVIATORE INCASSO 3 USCITE
BUILT-IN DIVERTER 3 OUT

parti esterne / external parts: 1703/3/E
parte incasso / built-in part: 034127

1803/3/E + 034127 | SUITE pag. 121



DEVIATORE INCASSO 3 USCITE C/SWAROVSKI
BUILT-IN DIVERTER 3 OUT WITH SWAROVSKI

parti esterne / external parts: 1803/3/E
parte incasso / built-in part: 034127

1403/4K/E + 034128 pag. 121



DEVIATORE INCASSO 4 USCITE
BUILT-IN DIVERTER 4 OUT

parti esterne / external parts: 1403/4K/E
parte incasso / built-in part: 034128

1603/4K/E + 034128 | SUITE pag. 122



DEVIATORE INCASSO 4 USCITE C/SWAROVSKI
BUILT-IN DIVERTER 4 OUT WITH SWAROVSKI

parti esterne / external parts: 1603/4K/E
parte incasso / built-in part: 034128

1703/4/E + 034128 pag. 122



DEVIATORE INCASSO 4 USCITE
BUILT-IN DIVERTER 4 OUT

parti esterne / external parts: 1703/4/E
parte incasso / built-in part: 034128

1803/4/E + 034128 | SUITE pag. 122

DEVIATORE INCASSO 4 USCITE C/SWAROVSKI
BUILT-IN DIVERTER 4 OUT WITH SWAROVSKI





parti esterne / external parts: 1803/4/E
parte incasso / built-in part: 034128

DOCCIA INCASSO TERMOSTATICO

1412/K/E + 484020 pag. 260*

MISCELATORE TERMOSTATICO INCASSO 1 USCITA
BUILT-IN THERMOSTATIC MIXER 1 OUT



parti esterne / external parts: 1412/K/E
parte incasso / built-in part: 484020

1612/K/E + 484020 | SUITE pag. 260*

MISCELATORE TERMOSTATICO INCASSO 1 USCITA C/SWAROVSKI
BUILT-IN THERMOSTATIC MIXER 1 OUT WITH SWAROVSKI



parti esterne / external parts: 1612/K/E
parte incasso / built-in part: 484020

1712/K/E + 484020 pag. 260*

MISCELATORE TERMOSTATICO INCASSO 1 USCITA
BUILT-IN THERMOSTATIC MIXER 1 OUT



parti esterne / external parts: 1712/K/E
parte incasso / built-in part: 484020

1812/K/E + 484020 | SUITE pag. 260*

MISCELATORE TERMOSTATICO INCASSO 1 USCITA C/SWAROVSKI
BUILT-IN THERMOSTATIC MIXER 1 OUT WITH SWAROVSKI



parti esterne / external parts: 1812/K/E
parte incasso / built-in part: 484020

1412/2K/E + 484021 pag. 260*

MISCELATORE TERMOSTATICO INCASSO C/DEVIATORE 2 USCITE
BUILT-IN THERMOSTATIC MIXER WITH DIVERTER 2 OUT



parti esterne / external parts: 1712/2K/E
parte incasso / built-in part: 484021

1612/2K/E + 484021 | SUITE pag. 261*

MISCELATORE TERMOSTATICO INCASSO C/DEVIATORE 2 USCITE C/SWAROVSKI
BUILT-IN THERMOSTATIC MIXER WITH DIVERTER 2 OUT AND SWAROVSKI



parti esterne / external parts: 1812/2K/E
parte incasso / built-in part: 484021

1712/2K/E + 484021 pag. 261*

MISCELATORE TERMOSTATICO INCASSO C/DEVIATORE 2 USCITE
BUILT-IN THERMOSTATIC MIXER WITH DIVERTER 2 OUT



parti esterne / external parts: 1712/2K/E
parte incasso / built-in part: 484021

1812/2K/E + 484021 | SUITE pag. 261*

MISCELATORE TERMOSTATICO INCASSO C/DEVIATORE 2 USCITE C/SWAROVSKI
BUILT-IN THERMOSTATIC MIXER WITH DIVERTER 2 OUT AND SWAROVSKI



parti esterne / external parts: 1812/2K/E
parte incasso / built-in part: 484021

1412/3K/E + 484022 pag. 261*

MISCELATORE TERMOSTATICO INCASSO C/DEVIATORE 3 USCITE
BUILT-IN THERMOSTATIC MIXER WITH DIVERTER 3 OUT



parti esterne / external parts: 1412/3K/E
parte incasso / built-in part: 484022

1612/3K/E + 484022 | SUITE pag. 261*

MISCELATORE TERMOSTATICO INCASSO C/DEVIATORE 3 USCITE C/SWAROVSKI
BUILT-IN THERMOSTATIC MIXER WITH DIVERTER 3 OUT AND SWAROVSKI



parti esterne / external parts: 1612/3K/E
parte incasso / built-in part: 484022



STRESA
STRESA
SUITE

* ABBINAMENTO CONSIGLIATO: PER PREZZI E SCHEDE TECNICHE, VEDI RIFERIMENTO PAGINA LISTINO REVIVRE
* RECOMMENDED COMBINATION: FOR PRICES AND TECHNICAL DETAILS, SEE PAGE REFERENCE PRICE REVIVRE

DOCCIA INCASSO TERMOSTATICO

1712/3K/E + 484022 pag. 262*

MISCELATORE TERMOSTATICO INCASSO C/DEVIATORE 3 USCITE
BUILT-IN THERMOSTATIC MIXER WITH DIVERTER 3 OUT

parti esterne / external parts: 1712/3K/E
parte incasso / built-in part: 484022



1812/3K/E + 484022 | SUITE pag. 262*

MISCELATORE TERMOSTATICO INCASSO C/DEVIATORE 3 USCITE C/SWAROVSKI
BUILT-IN THERMOSTATIC MIXER WITH DIVERTER 3 OUT AND SWAROVSKI

parti esterne / external parts: 1812/3K/E
parte incasso / built-in part: 484022



1412/4K/E + 484023 pag. 262*

MISCELATORE TERMOSTATICO INCASSO C/DEVIATORE 4 USCITE
BUILT-IN THERMOSTATIC MIXER WITH DIVERTER 4 OUT

parti esterne / external parts: 1412/4K/E
parte incasso / built-in part: 484023



1612/4K/E + 484023 | SUITE pag. 262*

MISCELATORE TERMOSTATICO INCASSO C/DEVIATORE 4 USCITE C/SWAROVSKI
BUILT-IN THERMOSTATIC MIXER WITH DIVERTER 4 OUT AND SWAROVSKI

parti esterne / external parts: 1612/4K/E
parte incasso / built-in part: 484023



1712/4K/E + 484023 pag. 262*

MISCELATORE TERMOSTATICO INCASSO C/DEVIATORE 4 USCITE
BUILT-IN THERMOSTATIC MIXER WITH DIVERTER 4 OUT

parti esterne / external parts: 1712/4K/E
parte incasso / built-in part: 484023



1812/4K/E + 484023 | SUITE pag. 263*

MISCELATORE TERMOSTATICO INCASSO C/DEVIATORE 4 USCITE C/SWAROVSKI
BUILT-IN THERMOSTATIC MIXER WITH DIVERTER 4 OUT AND SWAROVSKI

parti esterne / external parts: 1812/4K/E
parte incasso / built-in part: 484023



DOCCIA ESTERNO

1709/1 pag. 122

GRUPPO DOCCIA ESTERNO
EXTERNAL SHOWER GROUP



1809/1 | SUITE pag. 123

GRUPPO DOCCIA ESTERNO C/SWAROVSKI
EXTERNAL SHOWER GROUP WITH SWAROVSKI



1409/1 pag. 123

MISCELATORE DOCCIA ESTERNO
EXTERNAL SHOWER MIXER



1609/1 | SUITE pag. 123

MISCELATORE DOCCIA ESTERNO C/SWAROVSKI
EXTERNAL SHOWER MIXER WITH SWAROVSKI



DOCCIA COMPLEMENTI

1403/1/A pag. 134*

SUPPORTO DOCCIA COMPLETO
FULL SHOWER SUPPORT



144001 pag. 103*

SOFFIONE SAGOMATO ULTRASOTTILE
ULTRA THIN SHAPED CEILING



1430 pag. 141*

SALISCENDI COMPLETO C/PRESA D'ACQUA
COMPLETE WALL PIPE WITH WATER CONNECTION



1630 | SUITE pag. 141*

SALISCENDI COMPLETO C/PRESA D'ACQUA C/SWAROVSKI
COMPLETE WALL PIPE WITH WATER CONNECTION WITH SWAROVSKI



1730 pag. 142*

SALISCENDI COMPLETO C/PRESA D'ACQUA
COMPLETE WALL PIPE WITH WATER CONNECTION



1830 | SUITE pag. 142*

SALISCENDI COMPLETO C/PRESA D'ACQUA C/SWAROVSKI
COMPLETE WALL PIPE WITH WATER CONNECTION WITH SWAROVSKI



* ABBINAMENTO CONSIGLIATO: PER PREZZI E SCHEDE TECNICHE, VEDI RIFERIMENTO PAGINA LISTINO REVIVRE
* RECOMMENDED COMBINATION: FOR PRICES AND TECHNICAL DETAILS, SEE PAGE REFERENCE PRICE REVIVRE



STRESA
STRESA
SUITE

DOCCIA COMPLEMENTI



1430/1 pag. 146*
ASTA SALISCENDI
WALL PIPE



1630/1 | SUITE pag. 146*
ASTA SALISCENDI C/SWAROVSKI
WALL PIPE WITH SWAROVSKI



1730/1 pag. 147*
ASTA SALISCENDI
WALL PIPE



1830/1 | SUITE pag. 147*
ASTA SALISCENDI C/SWAROVSKI
WALL PIPE WITH SWAROVSKI

VASCA



1701/A pag. 123
GRUPPO VASCA ESTERNO
EXTERNAL BATH GROUP



1801/A | SUITE pag. 123
GRUPPO VASCA ESTERNO C/SWAROVSKI
EXTERNAL BATH GROUP WITH SWAROVSKI



1401/A pag. 124
MISCELATORE VASCA ESTERNO
EXTERNAL BATH MIXER



1601/A | SUITE pag. 124
MISCELATORE VASCA ESTERNO C/SWAROVSKI
EXTERNAL BATH MIXER WITH SWAROVSKI

NEW



1701/2/A pag. 124
BATTERIA PER BORDO VASCA
BATH RIM

NEW



1401/2/A pag. 124
MISCELATORE PER BORDO VASCA
BATH RIM MIXER



1400/2K/E + 724028 pag. 124
MISCELATORE INCASSO C/DEVIATORE, DOCCINO
E BOCCA
BUILT-IN MIXER WITH DIVETER HAND SHOWER AND
SPOUT



parti esterne / external parts: 1400/2K/E
parte incasso / built-in part: 724028



1600/2K/E + 724028 | SUITE pag. 125
MISCELATORE INCASSO C/DEVIATORE, DOCCINO E
BOCCA C/SWAROVSKI
BUILT-IN MIXER WITH DIVETER, HAND SHOWER,
SPOUT AND SWAROVSKI



parti esterne / external parts: 1600/2K/E
parte incasso / built-in part: 724028



1700/2K/E + 724028 pag. 125
MISCELATORE INCASSO C/DEVIATORE, DOCCINO
E BOCCA
BUILT-IN MIXER WITH DIVETER HAND SHOWER AND
SPOUT



parti esterne / external parts: 1700/2K/E
parte incasso / built-in part: 724028



1800/2K/E + 724028 | SUITE pag. 125
MISCELATORE INCASSO C/DEVIATORE E DOCCINO
C/SWAROVSKI
BUILT-IN MIXER WITH DIVETER, HAND SHOWER,
SPOUT AND SWAROVSKI



parti esterne / external parts: 1800/2K/E
parte incasso / built-in part: 724028



1701/26 pag. 125
GRUPPO VASCA C/RACCORDI A PAVIMENTO
FLOOR BATH GROUP



1801/26 | SUITE pag. 125
GRUPPO VASCA C/RACCORDI A PAVIMENTO
C/SWAROVSKI
FLOOR BATH GROUP WITH SWAROVSKI

VASCA



1401/26 pag. 126
 MISCELATORE VASCA C/RACCORDI A PAVIMENTO
 FLOOR BATH MIXER



1601/26 | SUITE pag. 126
 MISCELATORE VASCA C/RACCORDI A PAVIMENTO
 C/SWAROVSKI
 FLOOR BATH MIXER WITH SWAROVSKI



1403 pag. 126
 BOCCA VASCA DA PARETE
 WALL BATH SPOUT

BAGNO COMPLEMENTI

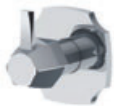

1408/E + 054025 o 054026 pag. 126
 RUBINETTO D'ARRESTO 1/2"
 BUILT-IN STOP COCK 1/2"



parti esterne / external parts: 1408/E
 parte incasso / built-in part: 054025 DX / 054026 SX



1608/E + 054025 o 054026 | SUITE pag. 126
 RUBINETTO D'ARRESTO 1/2" C/SWAROVSKI
 BUILT-IN STOP COCK 1/2" WITH SWAROVSKI



parti esterne / external parts: 1608/E
 parte incasso / built-in part: 054025 DX / 054026 SX



1708/C/E o 1708/F/E + 054025 pag. 127
 RUBINETTO D'ARRESTO 1/2"
 BUILT-IN STOP COCK 1/2"



parti esterne / external parts: 1708/C/E (calda)
 parti esterne / external parts: 1708/F/E (fredda)
 parte incasso / built-in part: 054025 DX



1808/C/E o 1808/F/E + 054025 | SUITE pag. 127
 RUBINETTO D'ARRESTO 1/2" C/SWAROVSKI
 BUILT-IN STOP COCK 1/2" WITH SWAROVSKI



parti esterne / external parts: 1808/C/E (calda)
 parti esterne / external parts: 1808/F/E (fredda)
 parte incasso / built-in part: 054025 DX

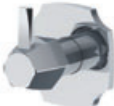

1408/E + 054027 o 054028 pag. 127
 RUBINETTO D'ARRESTO 3/4"
 BUILT-IN STOP COCK 3/4"



parti esterne / external parts: 1408/E
 parte incasso / built-in part: 054027 DX / 054028 SX



1608/E + 054027 o 054028 | SUITE pag. 127
 RUBINETTO D'ARRESTO 3/4" C/SWAROVSKI
 BUILT-IN STOP COCK 3/4" WITH SWAROVSKI



parti esterne / external parts: 1608/E
 parte incasso / built-in part: 054027 DX / 054028 SX



1708/C/E o 1708/F/E + 054027 pag. 127
 RUBINETTO D'ARRESTO 3/4"
 BUILT-IN STOP COCK 3/4"



parti esterne / external parts: 1708/C/E (calda)
 parti esterne / external parts: 1708/F/E (fredda)
 parte incasso / built-in part: 054027 DX



1808/C/E o 1808/F/E + 054027 | SUITE pag. 128
 RUBINETTO D'ARRESTO 3/4" C/SWAROVSKI
 BUILT-IN STOP COCK 3/4" WITH SWAROVSKI



parti esterne / external parts: 1808/C/E (calda)
 parti esterne / external parts: 1808/F/E (fredda)
 parte incasso / built-in part: 054027 DX

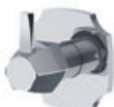

1440/E + 654099 pag. 128
 PASSO RAPIDO 3/4"
 BUILT-IN RAPID FLOW COCK 3/4"



parti esterne / external parts: 1440/E
 parte incasso / built-in part: 654099



1640/E + 654099 | SUITE pag. 128
 PASSO RAPIDO 3/4" C/SWAROVSKI
 BUILT-IN RAPID FLOW COCK 3/4" WITH SWAROVSKI



parti esterne / external parts: 1640/E
 parte incasso / built-in part: 654099



1740/E + 654099 pag. 128
 PASSO RAPIDO 3/4"
 BUILT-IN RAPID FLOW COCK 3/4"



parti esterne / external parts: 1740/E
 parte incasso / built-in part: 654099



1840/E + 654099 | SUITE pag. 128
 PASSO RAPIDO 3/4" C/SWAROVSKI
 BUILT-IN RAPID FLOW COCK 3/4" WITH SWAROVSKI



parti esterne / external parts: 1840/E
 parte incasso / built-in part: 654099



STRESA
 STRESA
 SUITE

DOCCIA COMPLEMENTI



1440/E + 654100 pag. 129

PASSO RAPIDO 1"
BUILT-IN RAPID FLOW COCK 1"



parti esterne / external parts: 1440/E
parte incasso / built-in part: 654100



1640/E + 654100 | SUITE pag. 129

PASSO RAPIDO 1" C/SWAROVSKI
BUILT-IN RAPID FLOW COCK 1" WITH SWAROVSKI



parti esterne / external parts: 1640/E
parte incasso / built-in part: 654100



1740/E + 654100 pag. 129

PASSO RAPIDO 1"
BUILT-IN RAPID FLOW COCK 1"



parti esterne / external parts: 1740/E
parte incasso / built-in part: 654100



1840/E + 654100 | SUITE pag. 129

PASSO RAPIDO 1" C/SWAROVSKI
BUILT-IN RAPID FLOW COCK 1" WITH SWAROVSKI



parti esterne / external parts: 1840/E
parte incasso / built-in part: 654100



1432/2/E + 035212 pag. 129

SARACINESCA
GATE VALVE



parti esterne / external parts: 1432/2/E
parte incasso / built-in part: 035212



1632/2/E + 035212 | SUITE pag. 130

SARACINESCA C/SWAROVSKI
GATE VALVE WITH SWAROVSKI



parti esterne / external parts: 1632/2/E
parte incasso / built-in part: 035212



1732/2/E + 035212 pag. 130

SARACINESCA
GATE VALVE



parti esterne / external parts: 1732/2/E
parte incasso / built-in part: 035212



1832/2/E + 035212 | SUITE pag. 130

SARACINESCA C/SWAROVSKI
GATE VALVE WITH SWAROVSKI



parti esterne / external parts: 1832/2/E
parte incasso / built-in part: 035212

1705/4

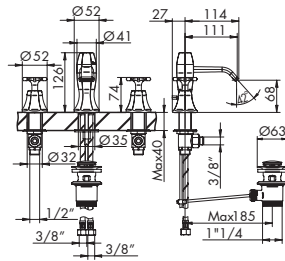

BATTERIA LAVABO TRE FORI

- > vitone ceramico 90°
- > interasse bocca 111
- > senza flessibili di alimentazione
- > con scarico
- > maniglia a croce



CROMATO
01-1705/4

ALTRE FINITURE
XX-1705/4

x M*

1805/4 | SUITE

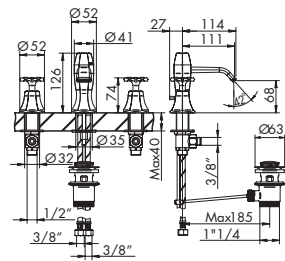

BATTERIA LAVABO TRE FORI C/SWAROVSKI

- > vitone ceramico 90°
- > interasse bocca 111
- > senza flessibili di alimentazione
- > con scarico
- > maniglia a croce
- > maniglie e centrale con SWAROVSKI



CROMATO
01-1805/4

ALTRE FINITURE
XX-1805/4

x M*

1705/4/S

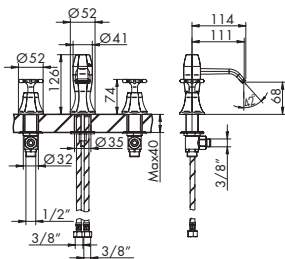

BATTERIA LAVABO TRE FORI

- > vitone ceramico 90°
- > senza flessibili di alimentazione
- > senza scarico
- > maniglia a croce

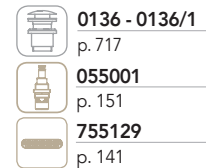

CROMATO
01-1705/4/S

ALTRE FINITURE
XX-1705/4/S

x M*

1805/4/S | SUITE

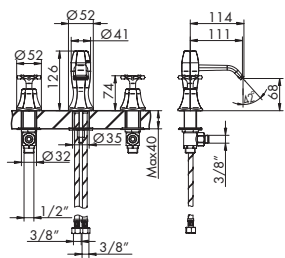

BATTERIA LAVABO TRE FORI C/SWAROVSKI

- > vitone ceramico 90°
- > interasse bocca 111
- > senza flessibili di alimentazione
- > senza scarico
- > maniglia a croce
- > maniglie e centrale con SWAROVSKI

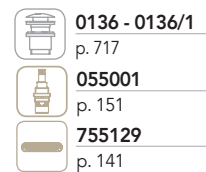

CROMATO
01-1805/4/S

ALTRE FINITURE
XX-1805/4/S

x M*

1705/4/A

NEW

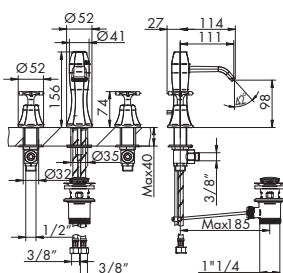

BATTERIA LAVABO MEDIUM TRE FORI

- > vitone ceramico 90°
- > interasse bocca 111
- > senza flessibili di alimentazione
- > con scarico
- > maniglia a croce



CROMATO
01-1705/4/A

ALTRE FINITURE
XX-1705/4/A

x M*

ACCESSORI



RICAMBI IMMEDIATI



XX = CODICE FINITURA RICHIESTA: per identificare codice corretto vedi pag. 98
M* = MOLTIPLICATORE: per calcolare il prezzo delle altre finiture vedi tabella pag. 98



1805/4/A | SUITE

NEW

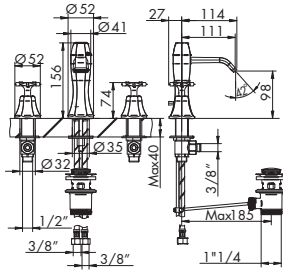

BATTERIA LAVABO MEDIUM TRE FORI C/SWAROVSKI

- > vitone ceramico 90°
- > interasse bocca 111
- > senza flessibili di alimentazione
- > con scarico
- > maniglia a croce
- > maniglie e centrale con SWAROVSKI

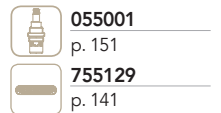

CROMATO

01-1805/4/A

ALTRE FINITURE

XX-1805/4/A

x M*

1705/4/A/S

NEW

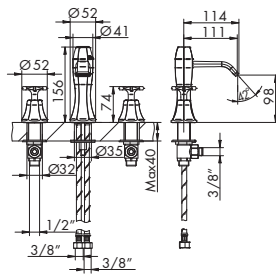

BATTERIA LAVABO MEDIUM TRE FORI

- > vitone ceramico 90°
- > interasse bocca 111
- > senza flessibili di alimentazione
- > senza scarico
- > maniglia a croce

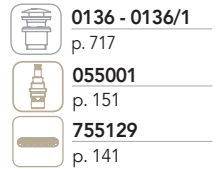

CROMATO

01-1705/4/A/S

ALTRE FINITURE

XX-1705/4/A/S

x M*

1805/4/A/S | SUITE

NEW

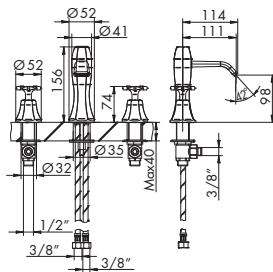

BATTERIA LAVABO MEDIUM TRE FORI C/SWAROVSKI

- > vitone ceramico 90°
- > interasse bocca 111
- > senza flessibili di alimentazione
- > senza scarico
- > maniglia a croce
- > maniglie e centrale con SWAROVSKI

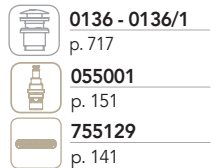

CROMATO

01-1805/4/A/S

ALTRE FINITURE

XX-1805/4/A/S

x M*

1705/2

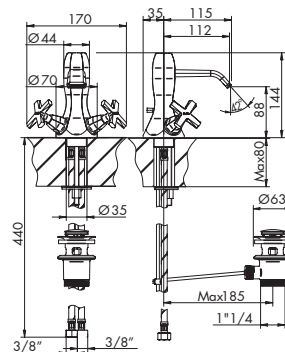

GRUPPO LAVABO MONOFORO

- > vitone ceramico 90°
- > interasse bocca 112
- > flessibili di alimentazione
- > con scarico
- > maniglia a croce



CROMATO

01-1705/2

ALTRE FINITURE

XX-1705/2

x M*

1805/2 | SUITE

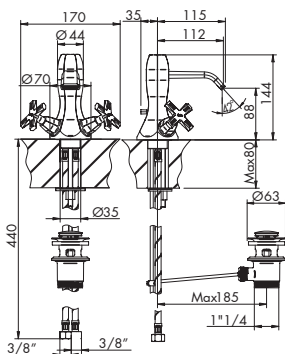

GRUPPO LAVABO MONOFORO C/SWAROVSKI

- > vitone ceramico 90°
- > interasse bocca 112
- > flessibili di alimentazione
- > con scarico
- > maniglia a croce
- > maniglie e corpo con SWAROVSKI

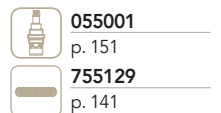

CROMATO

01-1805/2

ALTRE FINITURE

XX-1805/2

x M*

1705/2/S

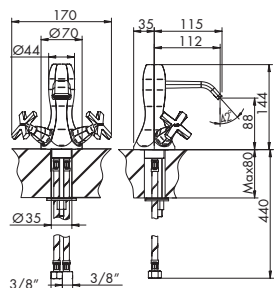

GRUPPO LAVABO MONOFORO

- > vitone ceramico 90°
- > interasse bocca 112
- > flessibili di alimentazione
- > senza scarico
- > maniglia a croce



CROMATO

01-1705/2/S

ALTRE FINITURE

XX-1705/2/S

x M*

1805/2/S | SUITE

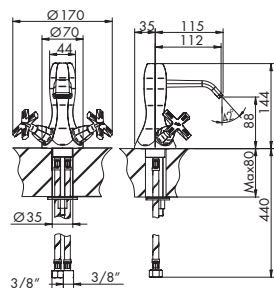

GRUPPO LAVABO MONOFORO C/SWAROVSKI

- > vitone ceramico 90°
- > interasse bocca 112
- > flessibili di alimentazione
- > senza scarico
- > maniglia a croce
- > maniglie e corpo con SWAROVSKI

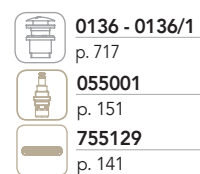

CROMATO

01-1805/2/S

ALTRE FINITURE

XX-1805/2/S

x M*

1405

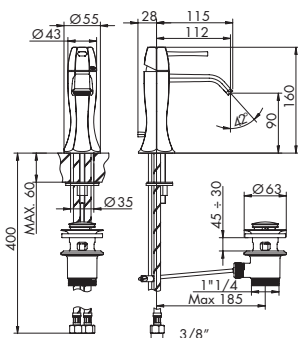

MISCELATORE LAVABO MONOFORO

- > cartuccia tradizionale
- > interasse bocca 112
- > flessibili di alimentazione
- > con scarico

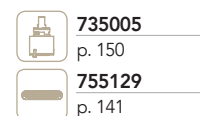

CROMATO

01-1405

ALTRE FINITURE

XX-1405

x M*

1605 | SUITE

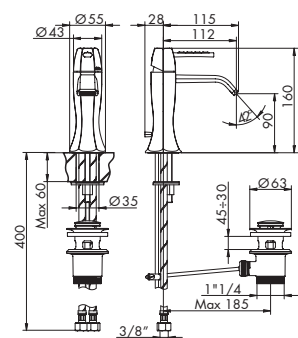

MISCELATORE LAVABO MONOFORO C/SWAROVSKI

- > cartuccia tradizionale
- > interasse bocca 112
- > flessibili di alimentazione
- > con scarico
- > maniglia e leva con SWAROVSKI



CROMATO

01-1605

ALTRE FINITURE

XX-1605

x M*

1405/S

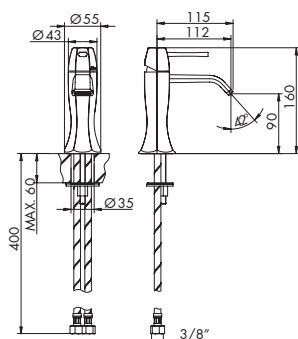

MISCELATORE LAVABO MONOFORO

- > cartuccia tradizionale
- > interasse bocca 112
- > flessibili di alimentazione
- > senza scarico

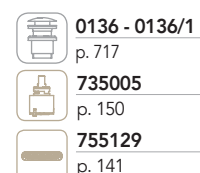

CROMATO

01-1405/S

ALTRE FINITURE

XX-1405/S

x M*

ACCESSORI



SCARICO C/TAPPO A PRESSIONE

RICAMBI IMMEDIATI



CARTUCCIA



VITONE CERAMICO



AERATORE PIATTO

XX = CODICE FINITURA RICHIESTA: per identificare codice corretto vedi pag. 98
M* = MOLTIPLICATORE: per calcolare il prezzo delle altre finiture vedi tabella pag. 98

1605/S | SUITE

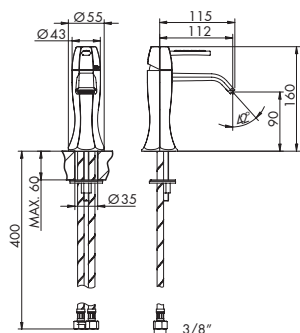

MISCELATORE LAVABO MONOFORO C/SWAROVSKI

- > cartuccia tradizionale
- > interasse bocca 112
- > flessibili di alimentazione
- > senza scarico
- > maniglia e leva con SWAROVSKI

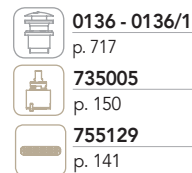

CROMATO

01-1605/S

ALTRE FINITURE

XX-1605/S

x M*

1405/P

NEW

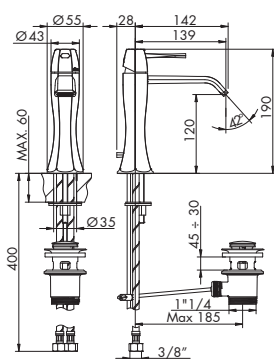

MISCELATORE LAVABO MEDIUM MONOFORO

- > cartuccia tradizionale
- > interasse bocca 139
- > flessibili di alimentazione
- > con scarico

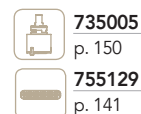

CROMATO

01-1405/P

ALTRE FINITURE

XX-1405/P

x M*

1605/P | SUITE

NEW

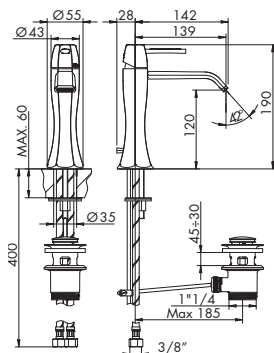

MISCELATORE LAVABO MEDIUM MONOFORO C/SWAROVSKI

- > cartuccia tradizionale
- > interasse bocca 139
- > flessibili di alimentazione
- > con scarico
- > maniglia e leva con SWAROVSKI

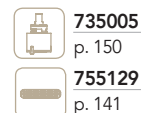

CROMATO

01-1605/P

ALTRE FINITURE

XX-1605/P

x M*

1405/P/S

NEW

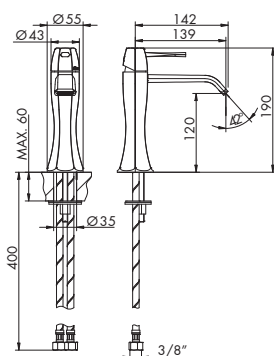

MISCELATORE LAVABO MEDIUM MONOFORO

- > cartuccia tradizionale
- > interasse bocca 139
- > flessibili di alimentazione
- > senza scarico

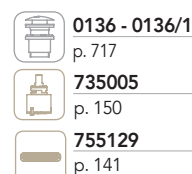

CROMATO

01-1405/P/S

ALTRE FINITURE

XX-1405/P/S

x M*

1605/P/S | SUITE

NEW

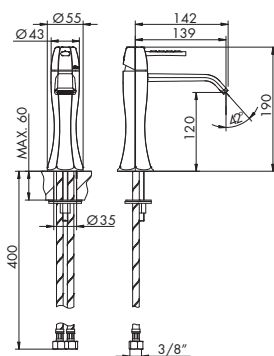

MISCELATORE LAVABO MEDIUM MONOFORO C/SWAROVSKI

- > cartuccia tradizionale
- > interasse bocca 139
- > flessibili di alimentazione
- > senza scarico
- > maniglia e leva con SWAROVSKI



CROMATO

01-1605/P/S

ALTRE FINITURE

XX-1605/P/S

x M*

1405/2

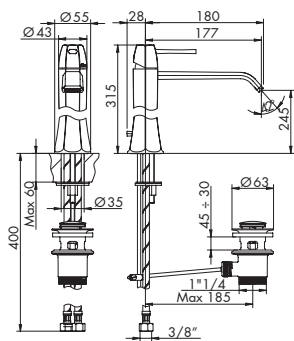

MISCELATORE LAVABO ALTO MONOFORO

- > cartuccia tradizionale
- > interasse bocca 177
- > flessibili di alimentazione
- > con scarico

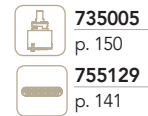

CROMATO

01-1405/2

ALTRE FINITURE

XX-1405/2

x M*

1605/2 | SUITE

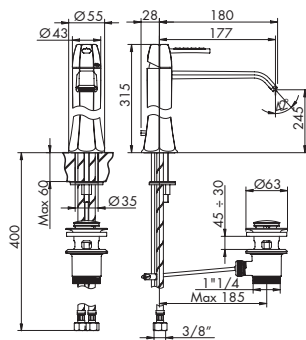

MISCELATORE LAVABO ALTO MONOFORO C/SWAROVSKI

- > cartuccia tradizionale
- > interasse bocca 177
- > flessibili di alimentazione
- > con scarico
- > maniglia e leva con SWAROVSKI

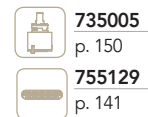

CROMATO

01-1605/2

ALTRE FINITURE

XX-1605/2

x M*

1405/1

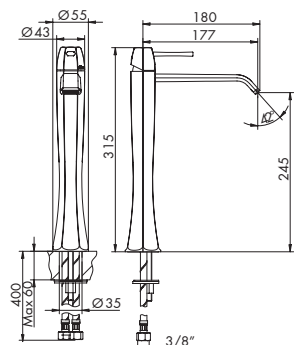

MISCELATORE LAVABO ALTO MONOFORO

- > cartuccia tradizionale
- > interasse bocca 177
- > flessibili di alimentazione
- > senza scarico

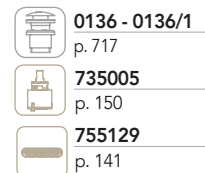

CROMATO

01-1405/1

ALTRE FINITURE

XX-1405/1

x M*

1605/1 | SUITE

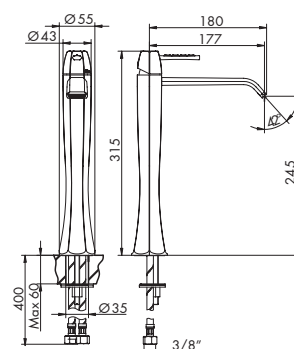

MISCELATORE LAVABO ALTO MONOFORO C/SWAROVSKI

- > cartuccia tradizionale
- > flessibili di alimentazione
- > senza scarico
- > abbinabile a bocche a soffitto pag.
- > maniglia con SWAROVSKI

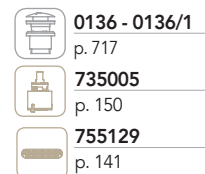

CROMATO

01-1605/1

ALTRE FINITURE

XX-1605/1

x M*

1705/3/E + 054061

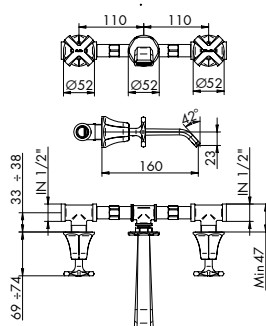

GRUPPO LAVABO DA PARETE

- > vitone ceramico 90°
- > interasse bocca 160
- > ingressi da 1/2"
- > senza scarico
- > rosoni separati

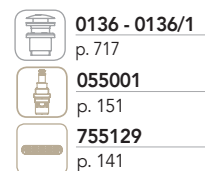

PARTI ESTERNE - CROMATO

01-1705/3/E

PARTI ESTERNE - ALTRE FINITURE

XX-1705/3/E

x M*

PARTE INCASSO

054061 info pag. 31

PREZZO TOTALE

ACCESSORI

SCARICO C/TAPPO
A PRESSIONE

RICAMBI IMMEDIATI



CARTUCCIA

VITONE
CERAMICOAERATORE
PIATTO

XX = CODICE FINITURA RICHIESTA: per identificare codice corretto vedi pag. 98
M* = MOLTIPLICATORE: per calcolare il prezzo delle altre finiture vedi tabella pag. 98



1805/3/E + 054061 | SUITE

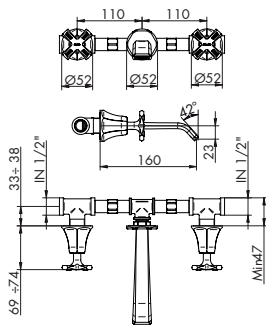

GRUPPO LAVABO DA PARETE C/SWAROVSKI

- > vitone ceramico 90°
- > interasse bocca 160
- > ingressi da 1/2"
- > senza scarico
- > rosoni separati
- > maniglie a croce con SWAROVSKI

| | |
|--|-------------------------|
| | 0136 - 0136/1 p. 717 |
| | 055001 p. 151 |
| | 755129 p. 141 |

PARTI ESTERNE - CROMATO

01-1805/3/E

PARTE INCASSO

054061 info pag. 31

PREZZO TOTALE

PARTI ESTERNE - ALTRE FINITURE

XX-1805/3/E

x M*

1705/3/1/E + 054061

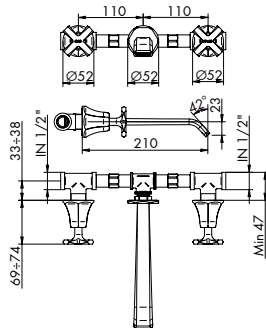

GRUPPO LAVABO DA PARETE BOCCA PROLUNGATA

- > vitone ceramico 90°
- > interasse bocca 210
- > ingressi da 1/2"
- > senza scarico
- > rosoni separati

| | |
|--|-------------------------|
| | 0136 - 0136/1 p. 717 |
| | 055001 p. 151 |
| | 755129 p. 141 |

PARTI ESTERNE - CROMATO

01-1705/3/1/E

PARTE INCASSO

054061 info pag. 31

PREZZO TOTALE

PARTI ESTERNE - ALTRE FINITURE

XX-1705/3/1/E

x M*

1805/3/1/E + 054061 | SUITE

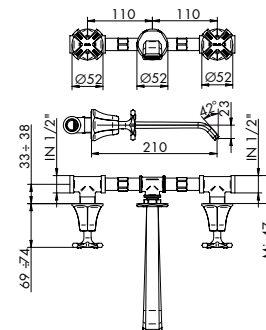

GRUPPO LAVABO DA PARETE BOCCA PROLUNGATA C/SWAROVSKI

- > vitone ceramico 90°
- > interasse bocca 210
- > ingressi da 1/2"
- > senza scarico
- > rosoni separati
- > maniglie a croce con SWAROVSKI

| | |
|--|-------------------------|
| | 0136 - 0136/1 p. 717 |
| | 055001 p. 151 |
| | 755129 p. 141 |

PARTI ESTERNE - CROMATO

01-1805/3/1/E

PARTE INCASSO

054061 info pag. 31

PREZZO TOTALE

PARTI ESTERNE - ALTRE FINITURE

XX-1805/3/1/E

x M*

1405/3K/E + 894001

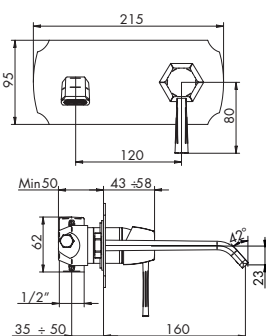

MISCELATORE LAVABO DA PARETE SU PIASTRA

- > cartuccia tradizionale
- > interasse bocca 160
- > ingressi da 1/2"
- > senza scarico
- > piastra unica

| | |
|--|-------------------------|
| | 0136 - 0136/1 p. 717 |
| | 025002 p. 149 |
| | 755129 p. 141 |

PARTI ESTERNE - CROMATO

01-1405/3K/E

PARTE INCASSO

01-894001 info pag. 34

PREZZO TOTALE

PARTI ESTERNE - ALTRE FINITURE

XX-1405/3K/E

x M*

1605/3K/E + 894001 | SUITE

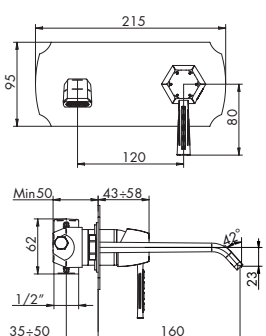

MISCELATORE LAVABO DA PARETE SU PIASTRA C/SWAROVSKI

- > cartuccia tradizionale
- > interasse bocca 160
- > ingressi da 1/2"
- > senza scarico
- > piastra unica
- > maniglia e leva con SWAROVSKI

| | |
|--|-------------------------|
| | 0136 - 0136/1 p. 717 |
| | 025002 p. 149 |
| | 755129 p. 141 |

PARTI ESTERNE - CROMATO

01-1605/3K/E

PARTE INCASSO

01-894001 info pag. 34

PREZZO TOTALE

PARTI ESTERNE - ALTRE FINITURE

XX-1605/3K/E

x M*

1405/3/1K/E + 894001

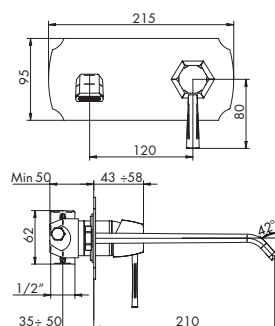
MISCELATORE LAVABO DA PARETE BOCCA PROL
SU PIASTRA

- > cartuccia tradizionale
- > interasse bocca 210
- > attacchi da 1/2"
- > senza scarico
- > piastra unica

PARTI ESTERNE - CROMATO

01-1405/3/1K/E

PARTE INCASSO

01-894001 info pag. 34

PREZZO TOTALE

PARTI ESTERNE - ALTRE FINITURE

XX-1405/3/1K/E

x M*

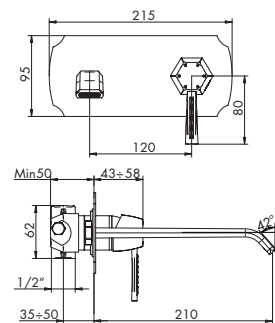

1605/3/1K/E + 894001 | SUITE

MISCELATORE LAVABO DA PARETE BOCCA PROL
SU PIASTRA C/SWAROVSKI

- > cartuccia tradizionale
- > interasse bocca 210
- > ingressi da 1/2"
- > senza scarico
- > piastra unica
- > maniglia e leva con SWAROVSKI

PARTI ESTERNE - CROMATO

01-1605/3/1K/E

PARTE INCASSO

01-894001 info pag. 34

PREZZO TOTALE

PARTI ESTERNE - ALTRE FINITURE

XX-1605/3/1K/E

x M*

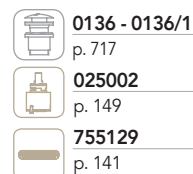

1405/R/A

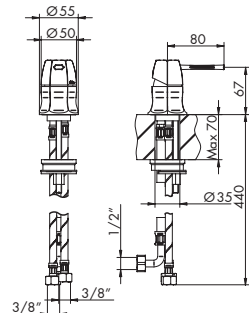

MISCELATORE REMOTO

- > cartuccia tradizionale
- > flessibili di alimentazione
- > senza scarico

CROMATO

01-1405/R/A

ALTRE FINITURE

XX-1405/R/A

x M*

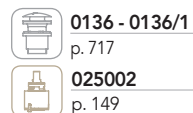

1605/R/A | SUITE

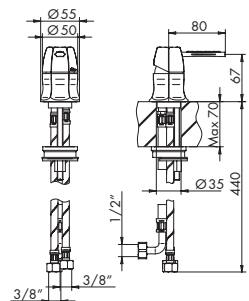

MISCELATORE REMOTO C/SWAROVSKI

- > cartuccia tradizionale
- > flessibili di alimentazione
- > senza scarico
- > maniglia e leva con SWAROVSKI

CROMATO

01-1605/R/A

ALTRE FINITURE

XX-1605/R/A

x M*

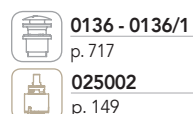

1405/R/B/E + 104033

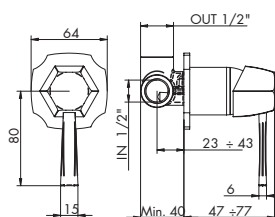

MISCELATORE INCASSO REMOTO

- > cartuccia tradizionale
- > ingressi da 1/2"
- > uscita superiore
- > senza scarico

PARTI ESTERNE - CROMATO

01-1405/R/B/E

PARTE INCASSO

01-104033 info pag. 32

PREZZO TOTALE

PARTI ESTERNE - ALTRE FINITURE

XX-1405/R/B/E

x M*



ACCESSORI

SCARICO C/TAPPO
A PRESSIONE

RICAMBI IMMEDIATI



CARTUCCIA

AERATORE
PIATTO

XX = CODICE FINITURA RICHIESTA: per identificare codice corretto vedi pag. 98
M* = MOLTIPLICATORE: per calcolare il prezzo delle altre finiture vedi tabella pag. 98



1605/R/B/E + 104033 | SUITE

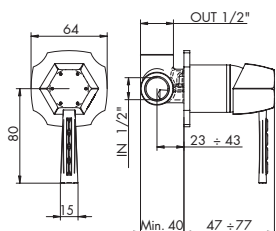

MISCELATORE INCASSO REMOTO C/SWAROVSKI

- > cartuccia tradizionale
- > ingressi da 1/2"
- > uscita superiore
- > senza scarico
- > maniglia e leva con SWAROVSKI

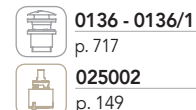

PARTI ESTERNE - CROMATO

01-1605/R/B/E

PARTE INCASSO

01-104033 info pag. 32

PREZZO TOTALE

PARTI ESTERNE - ALTRE FINITURE

XX-1605/R/B/E

x M*

1707/7

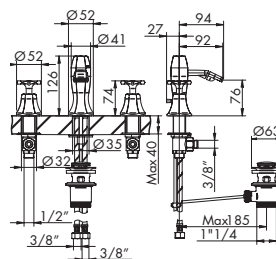

BATTERIA BIDET TRE FORI

- > vitone ceramico 90°
- > interasse bocca 92
- > maniglia a croce
- > aeratore snodato
- > senza flessibili di alimentazione
- > con scarico



CROMATO

01-1707/7

ALTRE FINITURE

XX-1707/7

x M*

1807/7 | SUITE

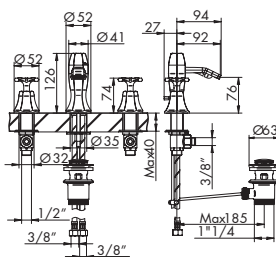

BATTERIA BIDET TRE FORI C/SWAROVSKI

- > vitone ceramico 90°
- > interasse bocca 92
- > maniglia a croce
- > aeratore snodato
- > senza flessibili di alimentazione
- > con scarico
- > maniglie e centrale con SWAROVSKI



CROMATO

01-1807/7

ALTRE FINITURE

XX-1807/7

x M*

1707/2

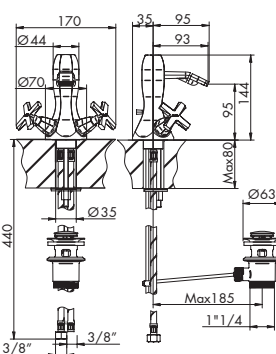

GRUPPO BIDET MONOFORO

- > vitone ceramico 90°
- > interasse bocca 93
- > maniglia a croce
- > aeratore snodato
- > flessibili di alimentazione
- > con scarico



CROMATO

01-1707/2

ALTRE FINITURE

XX-1707/2

x M*

1807/2 | SUITE

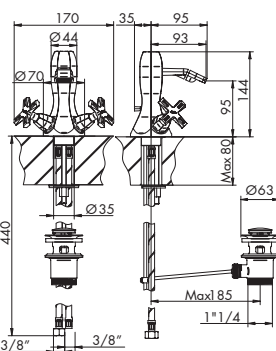

GRUPPO BIDET MONOFORO C/SWAROVSKI

- > vitone ceramico 90°
- > interasse bocca 93
- > maniglia a croce
- > aeratore snodato
- > flessibili di alimentazione
- > con scarico
- > maniglie e corpo con SWAROVSKI



CROMATO

01-1807/2

ALTRE FINITURE



XX-1807/2

x M*

1407

MISCELATORE BIDET MONOFORO

- > cartuccia tradizionale
- > interasse bocca 93
- > aeratore snodato
- > flessibili di alimentazione
- > con scarico

-  **735005**
p. 150
-  **755129**
p. 141

CROMATO
01-1407

ALTRE FINITURE
XX-1407

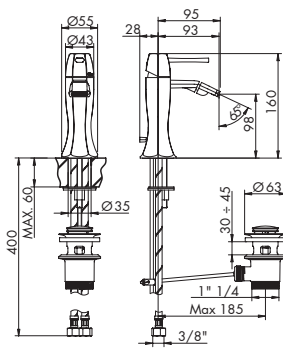

x M*



1607 | SUITE

MISCELATORE BIDET MONOFORO C/SWAROVSKI

- > cartuccia tradizionale
- > interasse bocca 93
- > aeratore snodato
- > flessibili di alimentazione
- > con scarico
- > maniglia e leva con SWAROVSKI

-  **735005**
p. 150
-  **755129**
p. 141

CROMATO
01-1607

ALTRE FINITURE
XX-1607

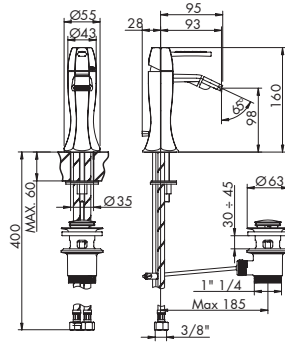

x M*



1700/3/E + 054059

GRUPPO INCASSO C/DEVIATORE 2 USCITE

- > vitone ceramico 90°
- > deviatore a dischi ceramici 2 uscite senza chiusura
- > maniglia a croce
- > attacchi da 1/2"

-  **055001**
p. 151
-  **635010**
p. 131

PARTI ESTERNE - CROMATO
01-1700/3/E

PARTI ESTERNE - ALTRE FINITURE
XX-1700/3/E

x M*

PARTE INCASSO
054059 info pag. 35

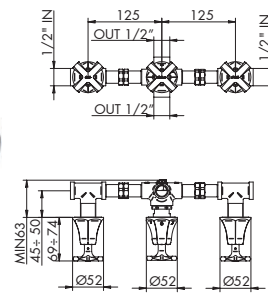

PREZZO TOTALE



1800/3/E + 054059 | SUITE

GRUPPO INCASSO C/DEVIATORE 2 USCITE C/SWAROVSKI

- > vitone ceramico 90°
- > deviatore a dischi ceramici 2 uscite senza chiusura
- > attacchi da 1/2"
- > maniglia a croce con SWAROVSKI

-  **055001**
p. 151
-  **635010**
p. 131

PARTI ESTERNE - CROMATO
01-1800/3/E

PARTI ESTERNE - ALTRE FINITURE
XX-1800/3/E

x M*

PARTE INCASSO
054059 info pag. 35

PREZZO TOTALE

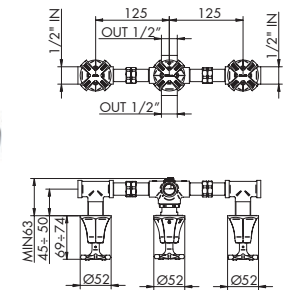
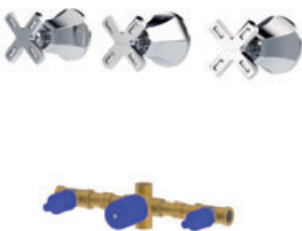

1421/K/E + 104018

MISCELATORE INCASSO

- > cartuccia tradizionale
- > attacchi da 1/2"
- > uscita superiore
- > incasso con B-Box

-  **025002**
p. 149

PARTI ESTERNE - CROMATO
01-1421/K/E

PARTI ESTERNE - ALTRE FINITURE
XX-1421/K/E

x M*

PARTE INCASSO
01-104018 info pag. 36

PREZZO TOTALE

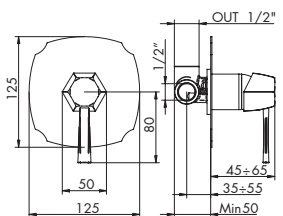

ACCESSORI



SCARICO C/TAPPO A PRESSIONE

RICAMBI IMMEDIATI



CARTUCCIA



VITONE CERAMICO



AERATORE PIATTO

XX = CODICE FINITURA RICHIESTA: per identificare codice corretto vedi pag. 98
M* = MOLTIPLICATORE: per calcolare il prezzo delle altre finiture vedi tabella pag. 98



STRESA
STRESA
SUITE

1621/K/E + 104018 | SUITE

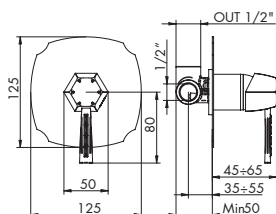

MISCELATORE INCASSO C/SWAROVSKI

- > cartuccia tradizionale
- > attacchi da 1/2"
- > uscita superiore
- > incasso con B-Box
- > maniglia e leva con SWAROVSKI

 025002
p. 149

PARTI ESTERNE - CROMATO

01-1621/K/E

PARTE INCASSO

01-104018 info pag. 36

PREZZO TOTALE

PARTI ESTERNE - ALTRE FINITURE

XX-1621/K/E

x M*

1721/K/E + 104018

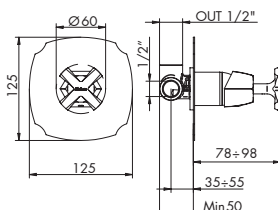

MISCELATORE INCASSO

- > cartuccia tradizionale
- > attacchi da 1/2"
- > uscita superiore
- > incasso con B-Box
- > maniglia a croce

 025002
p. 149

PARTI ESTERNE - CROMATO

01-1721/K/E

PARTE INCASSO

01-104018 info pag. 36

PREZZO TOTALE

PARTI ESTERNE - ALTRE FINITURE

XX-1721/K/E

x M*

1821/K/E + 104018 | SUITE

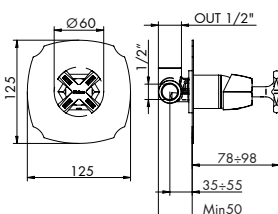

MISCELATORE INCASSO C/SWAROVSKI

- > cartuccia tradizionale
- > attacchi da 1/2"
- > uscita superiore
- > incasso con B-Box
- > maniglia a croce con SWAROVSKI

 025002
p. 149

PARTI ESTERNE - CROMATO

01-1821/K/E

PARTE INCASSO

01-104018 info pag. 36

PREZZO TOTALE

PARTI ESTERNE - ALTRE FINITURE

XX-1821/K/E

x M*

1400/K/E + 104002

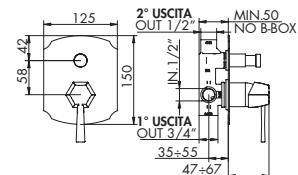

MISCELATORE INCASSO C/DEVIATORE 2 USCITE

- > cartuccia tradizionale
- > deviatore a pressione 2 uscite c/ritorno automatico e blocco meccanico basse pressioni
- > piastra classic
- > attacchi da 1/2"
- > uscita principale inferiore da 3/4"
- > incasso con B-Box

 025002
p. 149

 105029
p. 131

PARTI ESTERNE - CROMATO

01-1400/K/E

PARTE INCASSO

01-104002 info pag. 37

PREZZO TOTALE

PARTI ESTERNE - ALTRE FINITURE

XX-1400/K/E

x M*

1600/K/E + 104002 | SUITE

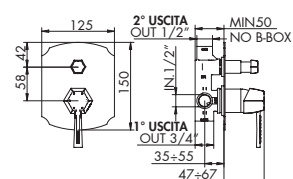

MISCELATORE INCASSO C/DEVIATORE 2 USCITE C/SWAROVSKI

- > cartuccia tradizionale
- > deviatore a pressione 2 uscite c/ritorno automatico e blocco meccanico basse pressioni
- > piastra classic
- > attacchi da 1/2"
- > uscita principale inferiore da 3/4"
- > incasso con B-Box
- > maniglia e leva con SWAROVSKI

 025002
p. 149

 105029
p. 131

PARTI ESTERNE - CROMATO

01-1600/K/E

PARTE INCASSO

01-104002 info pag. 37

PREZZO TOTALE

PARTI ESTERNE - ALTRE FINITURE

XX-1600/K/E

380,00 x M*



1700/K/E + 104002

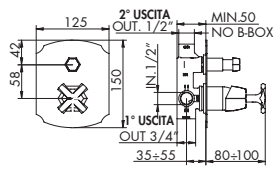

MISCELATORE INCASSO C/DEVIATORE 2 USCITE

- > cartuccia tradizionale
- > deviatore a pressione 2 uscite c/ritorno automatico e blocco meccanico basse pressioni
- > piastra classic > maniglia a croce
- > attacchi da 1/2"
- > uscita principale inferiore da 3/4"
- > incasso con B-Box

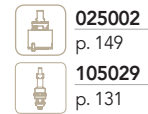

025002

p. 149

105029

p. 131

PARTI ESTERNE - CROMATO

01-1700/K/E

PARTI ESTERNE - ALTRE FINITURE

XX-1700/K/E

x M*

PARTE INCASSO

01-104002 info pag. 37

PREZZO TOTALE

1800/K/E + 104002 | SUITE

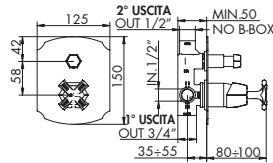
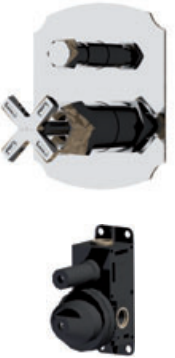

MISCELATORE INCASSO C/DEVIATORE 2 USCITE C/SWAROVSKI

- > cartuccia tradizionale
- > deviatore a pressione 2 uscite c/ritorno automatico e blocco meccanico basse pressioni
- > piastra classic > maniglia a croce
- > attacchi da 1/2" > uscita principale inferiore da 3/4"
- > incasso con B-Box > maniglia con SWAROVSKI

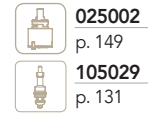

025002

p. 149

105029

p. 131

PARTI ESTERNE - CROMATO

01-1800/K/E

PARTI ESTERNE - ALTRE FINITURE

XX-1800/K/E

x M*

PARTE INCASSO

01-104002 info pag. 37

PREZZO TOTALE

1400/1K/E + 724027

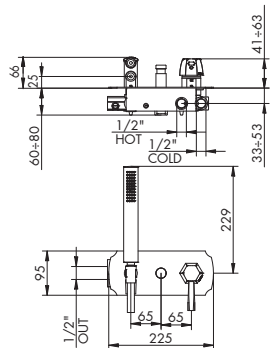

MISCELATORE INCASSO C/DEVIATORE E DOCCINO

- > cartuccia tradizionale
- > deviatore a pressione 2 uscite c/ritorno automatico e blocco meccanico basse pressioni
- > attacchi da 1/2"
- > doccetta monogetto in metallo
- > flessibile in PVC 150 cm > uscita principale fianco sinistro

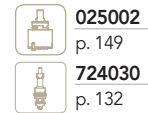

025002

p. 149

724030

p. 132

PARTI ESTERNE - CROMATO

01-1400/1K/E

PARTI ESTERNE - ALTRE FINITURE

XX-1400/1K/E

x M*

PARTE INCASSO

01-724027 info pag. 38

PREZZO TOTALE

1600/1K/E + 724027 | SUITE

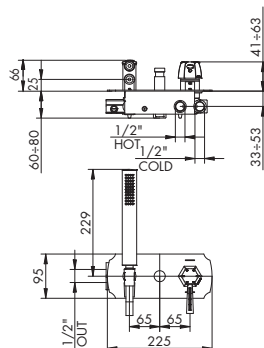

MISCELATORE INCASSO C/DEVIATORE E DOCCINO C/SWAROVSKI

- > cartuccia tradizionale
- > deviatore a pressione 2 uscite c/ritorno automatico e blocco meccanico basse pressioni
- > attacchi da 1/2" > doccetta monogetto in metallo
- > flessibile in PVC 150 cm > uscita principale fianco sinistro
- > maniglia e leva con SWAROVSKI

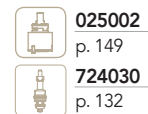

025002

p. 149

724030

p. 132

PARTI ESTERNE - CROMATO

01-1600/1K/E

PARTI ESTERNE - ALTRE FINITURE

XX-1600/1K/E

x M*

PARTE INCASSO

01-724027 info pag. 38

PREZZO TOTALE

1700/1K/E + 724027

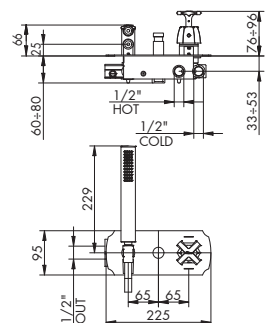

MISCELATORE INCASSO C/DEVIATORE E DOCCINO

- > cartuccia tradizionale
- > deviatore a pressione 2 uscite c/ritorno automatico e blocco meccanico basse pressioni
- > maniglia a croce
- > attacchi da 1/2"
- > doccetta monogetto in metallo
- > flessibile in PVC 150 cm



025002

p. 149

724030

p. 132

PARTI ESTERNE - CROMATO

01-1700/1K/E

PARTI ESTERNE - ALTRE FINITURE

XX-1700/1K/E

x M*

PARTE INCASSO

01-724027 info pag. 38

PREZZO TOTALE

RICAMBI IMMEDIATI



CARTUCCIA

DEVIATORE

XX = CODICE FINITURA RICHIESTA: per identificare codice corretto vedi pag. 98
 M* = MOLTIPLICATORE: per calcolare il prezzo delle altre finiture vedi tabella pag. 98



1800/1K/E + 724027 | SUITE

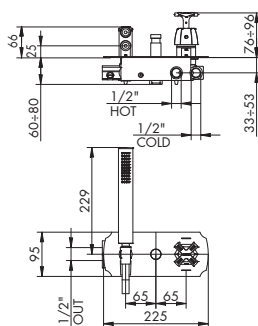

MISCELATORE INCASSO C/DEVIATORE E DOCCINO

C/SWAROVSKI

- > cartuccia tradizionale
- > deviatore a pressione 2 uscite c/ritorno automatico e blocco meccanico basse pressioni
- > maniglia a croce > attacchi da 1/2"
- > doccetta monogetto in metallo > con SWAROVSKI
- > flessibile in PVC 150 cm > con SWAROVSKI



025002

p. 149

724030

p. 132

PARTI ESTERNE - CROMATO

01-1800/1K/E

PARTI ESTERNE - ALTRE FINITURE

XX-1800/1K/E

x M*

PARTE INCASSO

01-724027

info pag. 38

PREZZO TOTALE

1403/2K/E + 914016

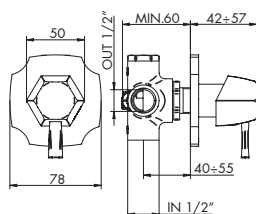

DEVIATORE INCASSO 2 USCITE

- > deviatore a dischi ceramici 2 uscite senza chiusura
- > attacchi da 1/2"



635010

p. 131

035346 fino 9.2017

p. 131

PARTI ESTERNE - CROMATO

01-1403/2K/E

PARTI ESTERNE - ALTRE FINITURE

XX-1403/2K/E

x M*

PARTE INCASSO

914016

info pag. 38

PREZZO TOTALE

1603/2K/E + 914016 | SUITE

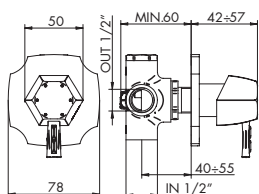

DEVIATORE INCASSO 2 USCITE C/SWAROVSKI

- > deviatore a dischi ceramici 2 uscite senza chiusura
- > attacchi da 1/2"
- > maniglia e leva con SWAROVSKI



635010

p. 131

035346 fino 9.2017

p. 131

PARTI ESTERNE - CROMATO

01-1603/2K/E

PARTI ESTERNE - ALTRE FINITURE

XX-1603/2K/E

x M*

PARTE INCASSO

914016

info pag. 38

PREZZO TOTALE

1703/2/E + 914016

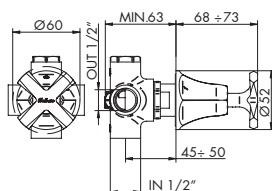

DEVIATORE INCASSO 2 USCITE

- > deviatore a dischi ceramici 2 uscite senza chiusura
- > maniglia a croce
- > attacchi da 1/2"



635010

p. 131

035346 fino 9.2017

p. 131

PARTI ESTERNE - CROMATO

01-1703/2/E

PARTI ESTERNE - ALTRE FINITURE

XX-1703/2/E

x M*

PARTE INCASSO

914016

info pag. 38

PREZZO TOTALE

1803/2/E + 914016 | SUITE

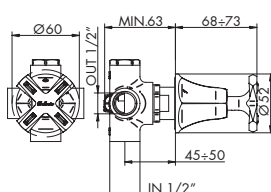

DEVIATORE INCASSO 2 USCITE C/SWAROVSKI

- > deviatore a dischi ceramici 2 uscite senza chiusura
- > maniglia a croce
- > attacchi da 1/2"
- > con SWAROVSKI

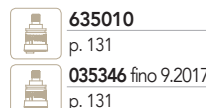

635010

p. 131

035346 fino 9.2017

p. 131

PARTI ESTERNE - CROMATO

01-1803/2/E

PARTI ESTERNE - ALTRE FINITURE

XX-1803/2/E

307,00 x M*

PARTE INCASSO

914016

info pag. 38

PREZZO TOTALE



CARTUCCIA



DEVIATORE



CARTUCCIA DEVIATRICE

1403/3K/E + 034127

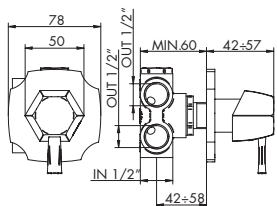

DEVIATORE INCASSO 3 USCITE

> deviatore a dischi ceramici 3 uscite senza chiusura
> attacchi da 1/2"

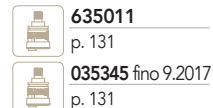

PARTI ESTERNE - CROMATO

01-1403/3K/E

PARTE INCASSO

034127 info pag. 38

PREZZO TOTALE

PARTI ESTERNE - ALTRE FINITURE

XX-1403/3K/E

1603/3K/E + 034127 | SUITE

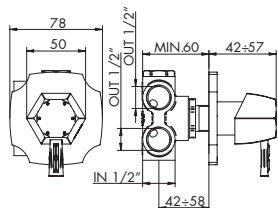

DEVIATORE INCASSO 3 USCITE C/SWAROVSKI

> deviatore a dischi ceramici 3 uscite senza chiusura
> attacchi da 1/2"
> maniglia e leva con SWAROVSKI



PARTI ESTERNE - CROMATO

01-1603/3K/E

PARTE INCASSO

034127 info pag. 38

PREZZO TOTALE

PARTI ESTERNE - ALTRE FINITURE

XX-1603/3K/E

1703/3/E + 034127

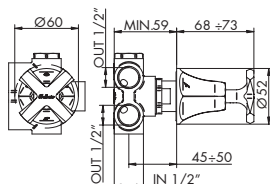

DEVIATORE INCASSO 3 USCITE

> deviatore a dischi ceramici 3 uscite senza chiusura
> maniglia a croce
> attacchi da 1/2"

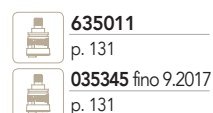

PARTI ESTERNE - CROMATO

01-1703/3/E

PARTE INCASSO

034127 info pag. 38

PREZZO TOTALE

PARTI ESTERNE - ALTRE FINITURE

XX-1703/3/E

1803/3/E + 034127 | SUITE

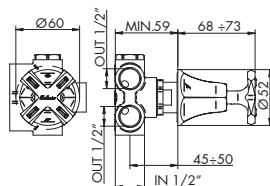

DEVIATORE INCASSO 3 USCITE C/SWAROVSKI

- deviatore a dischi ceramici 3 uscite senza chiusura
- maniglia a croce
- attacchi da 1/2"
- con SWAROVSKI



PARTI ESTERNE - CROMATO

01-1803/3/E

PARTE INCASSO

034127 info pag. 38

PREZZO TOTALE

PARTI ESTERNE - ALTRE FINITURE

XX-1803/3/E

1403/4K/E + 034128

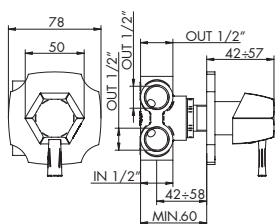

DEVIATORE INCASSO 4 USCITE

> deviatore a dischi ceramici 4 uscite senza chiusura
> attacchi da 1/2"



PARTI ESTERNE - CROMATO

01-1403/4K/E

PARTE INCASSO

034128 info pag. 38

PREZZO TOTALE

PARTI ESTERNE - ALTRE FINITURE

XX-1403/4K/E

x M*

1603/4K/E + 034128 | SUITE

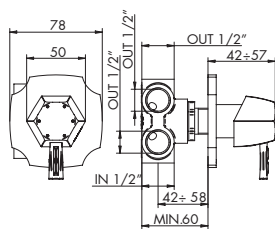

DEVIATORE INCASSO 4 USCITE C/SWAROVSKI

- > deviatore a dischi ceramici 4 uscite senza chiusura
- > attacchi da 1/2"
- > maniglia e leva con SWAROVSKI

635012
p. 131

035344 fino 9.2017
p. 131

| | |
|--------------------------------|--------------|
| PARTI ESTERNE - CROMATO | |
| 01-1603/4K/E | |
| PARTE INCASSO | |
| 034128 | info pag. 38 |
| PREZZO TOTALE | |

| | |
|---------------------------------------|------|
| PARTI ESTERNE - ALTRE FINITURE | |
| XX-1603/4K/E | x M* |

1703/4/E + 034128

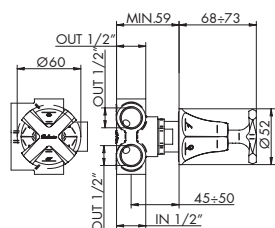

DEVIATORE INCASSO 4 USCITE

- > deviatore a dischi ceramici 4 uscite senza chiusura
- > attacchi da 1/2"
- > maniglia a croce

635012
p. 131

035344 fino 9.2017
p. 131

| | |
|--------------------------------|--------------|
| PARTI ESTERNE - CROMATO | |
| 01-1703/4/E | |
| PARTE INCASSO | |
| 034128 | info pag. 38 |
| PREZZO TOTALE | |

| | |
|---------------------------------------|------|
| PARTI ESTERNE - ALTRE FINITURE | |
| XX-1703/4/E | x M* |

1803/4/E + 034128 | SUITE

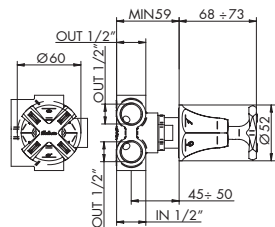

DEVIATORE INCASSO 4 USCITE C/SWAROVSKI

- > deviatore a dischi ceramici 4 uscite senza chiusura
- > attacchi da 1/2"
- > maniglia a croce con SWAROVSKI

635012
p. 131

035344 fino 9.2017
p. 131

| | |
|--------------------------------|--------------|
| PARTI ESTERNE - CROMATO | |
| 01-1803/4/E | |
| PARTE INCASSO | |
| 034128 | info pag. 38 |
| PREZZO TOTALE | |

| | |
|---------------------------------------|------|
| PARTI ESTERNE - ALTRE FINITURE | |
| XX-1803/4/E | x M* |

I DOCCIA INCASSO TERMOSTATICO CONSIGLIATI SONO PRESENTI SU LISTINO REVIVRE

| | | | |
|-------------------|--------------------|--------------------|--------------------|
| 1412/K/E + 484020 | 1412/2K/E + 484021 | 1412/3K/E + 484022 | 1412/4K/E + 484023 |
| 1612/K/E + 484020 | 1612/2K/E + 484021 | 1612/3K/E + 484022 | 1612/4K/E + 484023 |
| 1712/K/E + 484020 | 1712/2K/E + 484021 | 1712/3K/E + 484022 | 1712/4K/E + 484023 |
| 1812/K/E + 484020 | 1812/2K/E + 484021 | 1812/3K/E + 484022 | 1812/4K/E + 484023 |

I DOCCIA COMPLEMENTI CONSIGLIATI SONO PRESENTI SU LISTINO REVIVRE

| | | |
|----------|--------|--------|
| 1403/1/A | 1730 | 1730/1 |
| 144001 | 1830 | 1830/1 |
| 1430 | 1430/1 | |
| 1630 | 1630/1 | |

1709/1

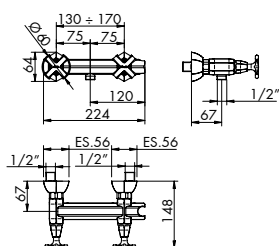

GRUPPO DOCCIA ESTERNO

- > vitone ceramico 90°
- > senza set doccia
- > attacchi da 1/2"
- > maniglia a croce

055001
p. 151

| | |
|----------------|---|
| CROMATO | |
| 01-1709/1 | € |

| | |
|-----------------------|--------|
| ALTRE FINITURE | |
| XX-1709/1 | € x M* |

1809/1 | SUITE

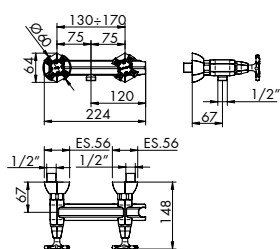

GRUPPO DOCCIA ESTERNO C/SWAROVSKI

- > vitone ceramico 90°
- > senza set doccia
- > attacchi da 1/2"
- > maniglia a croce con SWAROVSKI

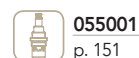

| CROMATO | ALTRE FINITURE |
|-------------|------------------|
| 01-1809/1 € | XX-1809/1 € x M* |

1409/1

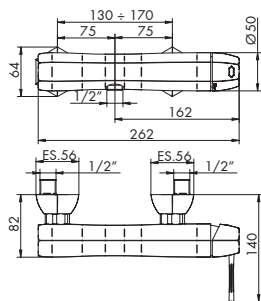

MISCELATORE DOCCIA ESTERNO

- > cartuccia tradizionale
- > senza set doccia
- > attacchi da 1/2"

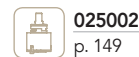

| CROMATO | ALTRE FINITURE |
|-------------|------------------|
| 01-1409/1 € | XX-1409/1 € x M* |

1609/1 | SUITE

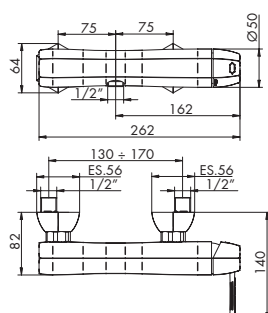

MISCELATORE DOCCIA ESTERNO C/SWAROVSKI

- > cartuccia tradizionale
- > senza set doccia
- > attacchi da 1/2"
- > maniglia e leva con SWAROVSKI



| CROMATO | ALTRE FINITURE |
|-------------|------------------|
| 01-1609/1 € | XX-1609/1 € x M* |

1701/A

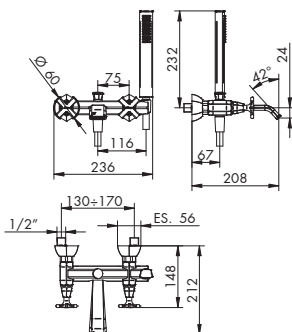

GRUPPO VASCA ESTERNO

- > vitone ceramico 90°
- > Interasse bocca 208
- > deviatore a trazione con ritorno automatico e blocco meccanico basse pressioni
- > flessibile in PVC 150 cm
- > Gancio fisso incorporato
- > attacchi da 1/2"
- > maniglia a croce
- > Doccetta monogetto in metallo c/anticalcare

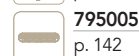
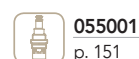

| CROMATO | ALTRE FINITURE |
|-------------|------------------|
| 01-1701/A € | XX-1701/A € x M* |

1801/A | SUITE

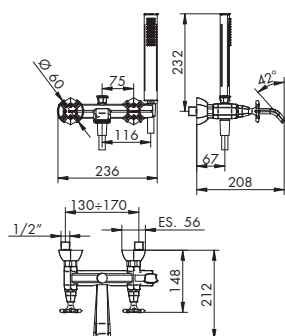

GRUPPO VASCA ESTERNO C/SWAROVSKI

- > vitone ceramico 90°
- > interasse bocca 208
- > deviatore a trazione con ritorno automatico e blocco meccanico basse pressioni
- > flessibile in PVC 150 cm
- > gancio fisso incorporato
- > attacchi da 1/2"
- > maniglia a croce con SWAROVSKI
- > doccetta monogetto in metallo c/anticalcare

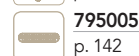
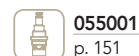

| CROMATO | ALTRE FINITURE |
|-------------|------------------|
| 01-1801/A € | XX-1801/A € x M* |

RICAMBI IMMEDIATI



XX = CODICE FINITURA RICHIESTA: per identificare codice corretto vedi pag. 98
M* = MOLTIPLICATORE: per calcolare il prezzo delle altre finiture vedi tabella pag. 98

1401/A

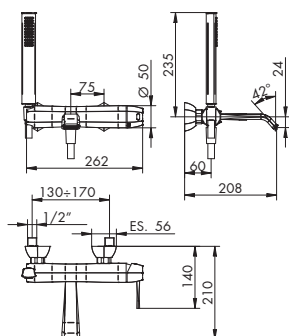

MISCELATORE VASCA ESTERNO

- > cartuccia tradizionale
- > Interasse bocca 205
- > deviatore a trazione/spinta senza ritorno automatico
- > flessibile in PVC 150 cm
- > gancio fisso incorporato
- > attacchi da 1/2"
- > doccetta monogetto in metallo c/anticalcare

| | | |
|--|--------|--------|
| | 025002 | p. 149 |
| | 654020 | p. 132 |
| | 795005 | p. 142 |

| | |
|----------------|-----------------------|
| CROMATO | ALTRE FINITURE |
| 01-1401/A | XX-1401/A x M* |

1601/A | SUITE

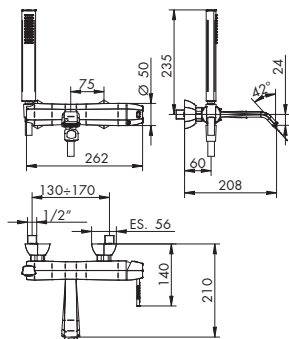

MISCELATORE VASCA ESTERNO C/SWAROVSKI

- > cartuccia tradizionale
- > Interasse bocca 205
- > deviatore a trazione/spinta senza ritorno automatico
- > flessibile in PVC 150 cm
- > gancio fisso incorporato
- > attacchi da 1/2"
- > maniglia e leva con SWAROVSKI
- > doccetta monogetto in metallo c/anticalcare

| | | |
|--|--------|--------|
| | 025002 | p. 149 |
| | 654020 | p. 132 |
| | 795005 | p. 142 |

| | |
|----------------|-----------------------|
| CROMATO | ALTRE FINITURE |
| 01-1601/A | XX-1601/A x M* |

1701/2/A

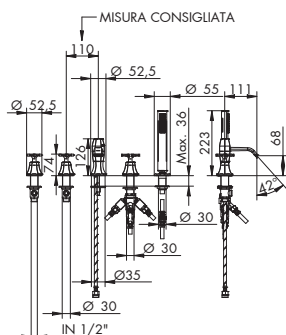

BATTERIA PER BORDO VASCA

- > vitone ceramico 90°
- > Interasse bocca 111
- > deviatore a dischi ceramici 2 uscite
- > flessibile in PVC 150 cm
- > senza flessibili di alimentazione
- > senza scarico
- > maniglia a croce
- > doccetta monogetto in metallo c/anticalcare
- > PREDISPOSIZIONI per bordo vasca, art. 012/5, 012/6 e 012/7, vedi pag. 615

| | | |
|--|--------|--------|
| | 055001 | p. 151 |
| | 795005 | p. 142 |

| | |
|----------------|-------------------------|
| CROMATO | ALTRE FINITURE |
| 01-1701/2/A | XX-1701/2/A x M* |

1401/2/A

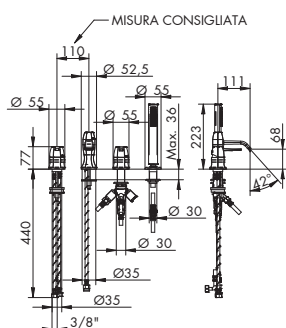

MISCELATORE PER BORDO VASCA

- > cartuccia tradizionale
- > Interasse bocca 111
- > deviatore a dischi ceramici 2 OUT
- > doccetta monogetto in metallo c/anticalcare
- > flessibile in PVC 150 cm
- > flessibili di alimentazione
- > senza scarico
- > PREDISPOSIZIONI per bordo vasca, art. 012/4, 012/6 e 012/7, vedi pag. 615

| | | |
|--|--------|--------|
| | 025002 | p. 149 |
| | 795005 | p. 142 |

| | |
|----------------|-------------------------|
| CROMATO | ALTRE FINITURE |
| 01-1401/2/A | XX-1401/2/A x M* |

1400/2K/E + 724028

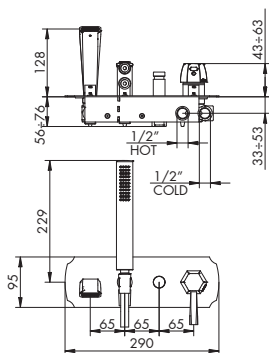

MISCELATORE INCASSO C/DEVIATORE, DOCCINO E BOCCA

- > cartuccia tradizionale
- > Interasse bocca 128
- > deviatore a pressione 2 uscite c/ritorno automatico e blocco meccanico basse pressioni
- > attacchi da 1/2"
- > flessibile in PVC 150 cm
- > doccetta monogetto in metallo

| | | |
|--|--------|--------|
| | 025002 | p. 149 |
| | 724030 | p. 132 |
| | 795005 | p. 142 |

| | |
|--------------------------------|---------------------------------------|
| PARTI ESTERNE - CROMATO | PARTI ESTERNE - ALTRE FINITURE |
| 01-1400/2K/E | XX-1400/2K/E x M* |
| PARTE INCASSO | |
| 01-724028 | info pag. 39 |
| PREZZO TOTALE | |

1600/2K/E + 724028 | SUITE

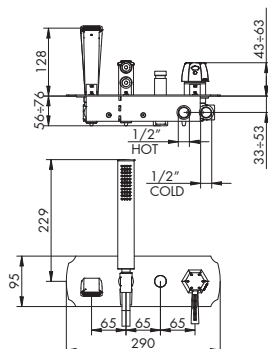

MISCELATORE INCASSO C/DEVIATORE, DOCCINO E BOCCA C/SWAROVSKI

- > cartuccia tradizionale > interasse bocca 128
- > deviatore a pressione 2 uscite c/ritorno automatico e blocco meccanico basse pressioni
- > attacchi da 1/2"
- > doccetta monogetto in metallo > flessibile in PVC 150 cm
- > maniglia e leva con SWAROVSKI

| | | |
|--|--------|--------|
| | 025002 | p. 149 |
| | 724030 | p. 132 |
| | 795005 | p. 142 |

PARTI ESTERNE - CROMATO

01-1600/2K/E

PARTI ESTERNE - ALTRE FINITURE

XX-1600/2K/E

x M*

PARTE INCASSO

01-724028 info pag. 39

PREZZO TOTALE

1700/2K/E + 724028

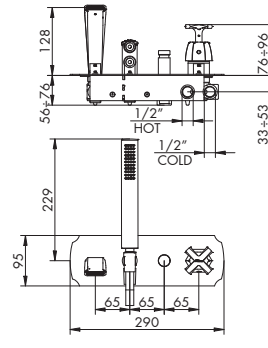

MISCELATORE INCASSO C/DEVIATORE, DOCCINO E BOCCA

- > cartuccia tradizionale
- > interasse bocca 128
- > deviatore a pressione 2 uscite c/ritorno automatico e blocco meccanico basse pressioni
- > maniglia a croce > attacchi da 1/2"
- > doccetta monogetto in metallo
- > flessibile in PVC 150 cm

| | | |
|--|--------|--------|
| | 025002 | p. 149 |
| | 724030 | p. 132 |
| | 795005 | p. 142 |

PARTI ESTERNE - CROMATO

01-1700/2K/E

PARTI ESTERNE - ALTRE FINITURE

XX-1700/2K/E

x M*

PARTE INCASSO

01-724028 info pag. 39

PREZZO TOTALE

1800/2K/E + 724028 | SUITE

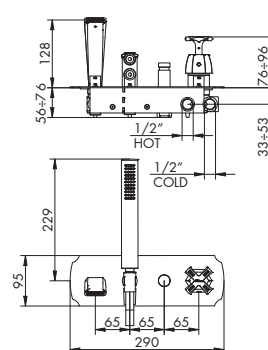

MISCELATORE INCASSO C/DEVIATORE, DOCCINO E BOCCA C/SWAROVSKI

- > cartuccia tradizionale > interasse bocca 128
- > deviatore a pressione 2 uscite c/ritorno automatico e blocco meccanico basse pressioni
- > maniglia a croce > attacchi da 1/2"
- > doccetta monogetto in metallo > flessibile in PVC 150 cm
- > con SWAROVSKI

| | | |
|--|--------|--------|
| | 025002 | p. 149 |
| | 724030 | p. 132 |
| | 795005 | p. 142 |

PARTI ESTERNE - CROMATO

01-1800/2K/E

PARTI ESTERNE - ALTRE FINITURE

XX-1800/2K/E

x M*

PARTE INCASSO

01-724028 info pag. 39

PREZZO TOTALE

1701/26

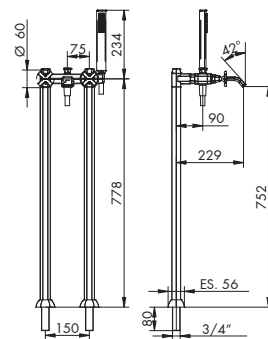

GRUPPO VASCA C/RACCORDI A PAVIMENTO

- > vitone ceramico 90°
- > interasse bocca 229
- > deviatore a trazione con ritorno automatico e blocco meccanico basse pressioni
- > flessibile in PVC 150 cm > gancio fisso incorporato
- > attacchi da 3/4"
- > maniglia a croce
- > doccetta monogetto in metallo c/anticalcare
- > PREDISPOSIZIONI per gruppo vasca c/raccordi a pavimento, art. 054062, vedi pag. 734

| | | |
|--|--------|--------|
| | 055001 | p. 151 |
| | 174012 | p. 131 |
| | 795005 | p. 142 |

CROMATO

01-1701/26

ALTRE FINITURE

XX-1701/26

x M*

1801/26 | SUITE

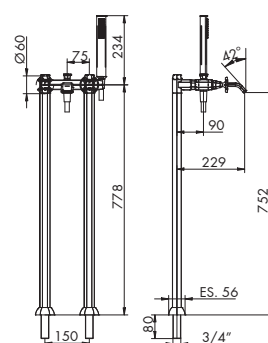

GRUPPO VASCA C/RACCORDI A PAVIMENTO C/SWAROVSKI

- > vitone ceramico 90°
- > interasse bocca 229
- > deviatore a trazione con ritorno automatico e blocco meccanico basse pressioni
- > flessibile in PVC 150 cm > gancio fisso incorporato
- > attacchi da 3/4" > maniglia a croce con SWAROVSKI
- > doccetta monogetto in metallo c/anticalcare
- > PREDISPOSIZIONI per gruppo vasca c/raccordi a pavimento, art. 054062, vedi pag. 734

| | | |
|--|--------|--------|
| | 055001 | p. 151 |
| | 174012 | p. 131 |
| | 795005 | p. 142 |

CROMATO

01-1801/26

ALTRE FINITURE

XX-1801/26

x M*

RICAMBI IMMEDIATI



XX = CODICE FINITURA RICHIESTA: per identificare codice corretto vedi pag. 98
 M* = MOLTIPLICATORE: per calcolare il prezzo delle altre finiture vedi tabella pag. 98



1401/26

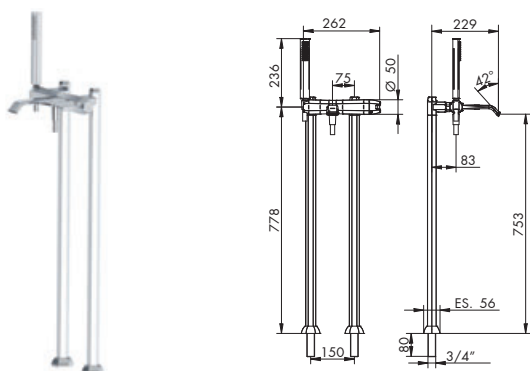

MISCELATORE VASCA C/RACCORDI A PAVIMENTO

- > cartuccia tradizionale
- > Interasse bocca 229
- > deviatore a trazione/spinta senza ritorno automatico
- > flessibile in PVC 150 cm
- > gancio fisso incorporato
- > attacchi da 3/4"
- > doccetta monogetto in metallo c/anticalcare
- > PREDISPOSIZIONI per mix vasca c/raccordi a pavimento, art. 054062, vedi pag. 734

- 025002 p. 149
- 654020 p. 132
- 795005 p. 142

| | |
|----------------|-----------------------|
| CROMATO | ALTRE FINITURE |
| 01-1401/26 | XX-1401/26 x M* |

1601/26 | SUITE

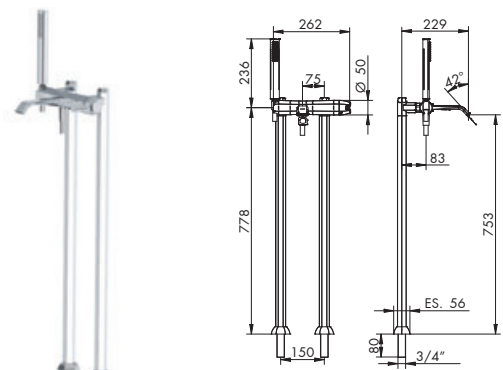

MISCELATORE VASCA C/RACCORDI A PAVIMENTO C/SWAROVSKI

- > cartuccia tradizionale
- > Interasse bocca 229
- > deviatore a trazione senza ritorno automatico
- > doccetta monogetto in metallo c/anticalcare
- > flessibile in PVC 150 cm
- > gancio fisso incorporato
- > attacchi da 3/4"
- > maniglia e leva con SWAROVSKI
- > PREDISPOSIZIONI per mix vasca c/raccordi a pavimento, art. 054062, vedi pag. 734

- 025002 p. 149
- 654020 p. 132
- 795005 p. 142

| | |
|----------------|-----------------------|
| CROMATO | ALTRE FINITURE |
| 01-1601/26 | XX-1601/26 x M* |

1403

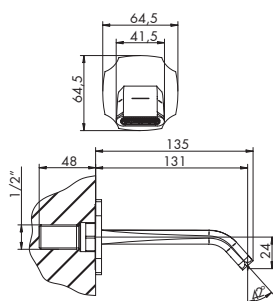

BOCCA VASCA DA PARETE

- > interasse bocca 131
- > attacco da 1/2"

- 795005 p. 142

| | |
|------------------|-----------------------|
| CROMATO | ALTRE FINITURE |
| 01-1403 € 267,00 | XX-1403 € 267,00 x M* |

1408/E + 054025 DX o 054026 SX

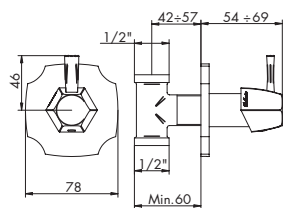

RUBINETTO D'ARRESTO 1/2"

- > vitone ceramico 90°
- > ingressi da 1/2"

- 055001 p. 151
- 055002 p. 151

| | |
|--------------------------------|---------------------------------------|
| PARTI ESTERNE - CROMATO | PARTI ESTERNE - ALTRE FINITURE |
| 01-1408/E | XX-1408/E x M* |
| PARTE INCASSO | |
| 054025 o 054026 info pag. 40 | |
| PREZZO TOTALE | |

1608/E + 054025 DX o 054026 SX | SUITE

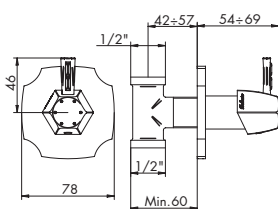

RUBINETTO D'ARRESTO 1/2" C/SWAROVSKI

- > vitone ceramico 90°
- > ingressi da 1/2"
- > maniglia e leva con SWAROVSKI

- 055001 p. 151
- 055002 p. 151

| | |
|--------------------------------|---------------------------------------|
| PARTI ESTERNE - CROMATO | PARTI ESTERNE - ALTRE FINITURE |
| 01-1608/E | XX-1608/E x M* |
| PARTE INCASSO | |
| 054025 o 054026 info pag. 40 | |
| PREZZO TOTALE | |

1708/C/E (calda) + 054025 DX
1708/F/E (fredda) + 054025 DX

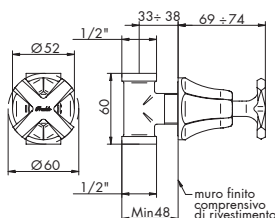

RUBINETTO D'ARRESTO 1/2"

- > vitone ceramico 90°
- > maniglia a croce scritta "CALDA" (per art. 1708/C/E)
- > maniglia a croce scritta "FREDDA" (per art. 1708/F/E)
- > ingressi da 1/2"

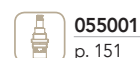

PARTI ESTERNE - CROMATO

01-1708/C/E

01-1708/F/E

PARTI ESTERNE - ALTRE FINITURE

XX-1708/C/E

XX-1708/F/E

x M*

x M*

PARTE INCASSO

054025 info pag. 40

PREZZO TOTALE

1808/C/E (calda) + 054025 DX | SUITE
1808/F/E (fredda) + 054025 DX | SUITE

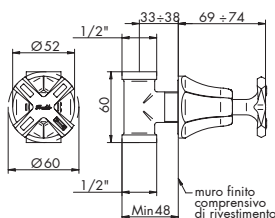

RUBINETTO D'ARRESTO 1/2" C/SWAROVSKI

- > vitone ceramico 90°
- > maniglia a croce scritta "CALDA" con SWAROVSKI (per art. 1808/C/E)
- > maniglia a croce scritta "FREDDA" con SWAROVSKI (per art. 1808/F/E)
- > ingressi da 1/2"

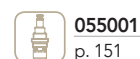

PARTI ESTERNE - CROMATO

01-1808/C/E

01-1808/F/E

PARTI ESTERNE - ALTRE FINITURE

XX-1808/C/E

XX-1808/F/E

x M*

x M*

PARTE INCASSO

054025 info pag. 40

PREZZO TOTALE

1408/E + 054027 DX o 054028 SX

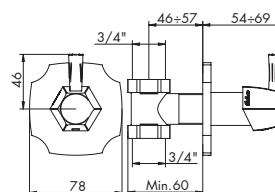

RUBINETTO D'ARRESTO 3/4"

- > vitone ceramico 90°
- > ingressi da 3/4"

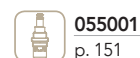

PARTI ESTERNE - CROMATO

01-1408/E

PARTI ESTERNE - ALTRE FINITURE

XX-1408/E

x M*

PARTE INCASSO

054027 o 054028 info pag. 40

PREZZO TOTALE

1608/E + 054027 DX o 054028 SX | SUITE

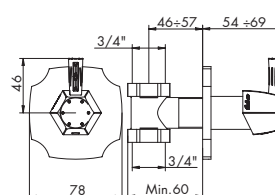

RUBINETTO D'ARRESTO 3/4" C/SWAROVSKI

- > vitone ceramico 90°
- > ingressi da 3/4"
- > maniglia e leva con SWAROVSKI

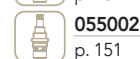
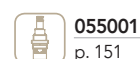

PARTI ESTERNE - CROMATO

01-1608/E

PARTI ESTERNE - ALTRE FINITURE

XX-1608/E

x M*

PARTE INCASSO

054027 o 054028 info pag. 40

PREZZO TOTALE

1708/C/E (calda) + 054027 DX
1708/F/E (fredda) + 054027 DX

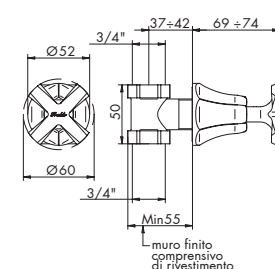

RUBINETTO D'ARRESTO 3/4"

- > vitone ceramico 90°
- > maniglia a croce scritta "CALDA" (per art. 1708/C/E)
- > maniglia a croce scritta "FREDDA" (per art. 1708/F/E)
- > ingressi da 3/4"

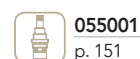

PARTI ESTERNE - CROMATO

01-1708/C/E

01-1708/F/E

PARTI ESTERNE - ALTRE FINITURE

XX-1708/C/E

XX-1708/F/E

x M*

x M*

PARTE INCASSO

054027 info pag. 40

PREZZO TOTALE

RICAMBI IMMEDIATI



VITONE CERAMICO

XX = CODICE FINITURA RICHIESTA: per identificare codice corretto vedi pag. 98
M* = MOLTIPLICATORE: per calcolare il prezzo delle altre finiture vedi tabella pag. 98

1808/C/E (calda) + 054027 DX | SUITE
1808/F/E (fredda) + 054027 DX | SUITE

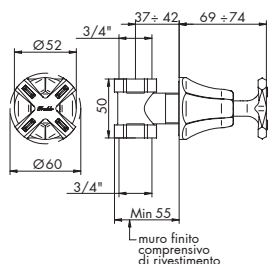

RUBINETTO D'ARRESTO 3/4" C/SWAROVSKI

- > vitone ceramico 90°
- > maniglia a croce scritta "CALDA" con SWAROVSKI (per art. 1808/C/E)
- > maniglia a croce scritta "FREDDA" con SWAROVSKI (per art. 1808/F/E)
- > ingressi da 3/4"



PARTI ESTERNE - CROMATO

01-1808/C/E
01-1808/F/E

PARTI ESTERNE - ALTRE FINITURE

XX-1808/C/E x M*
XX-1808/F/E x M*

PARTE INCASSO

054027 info pag. 40

PREZZO TOTALE

1440/E + 654099

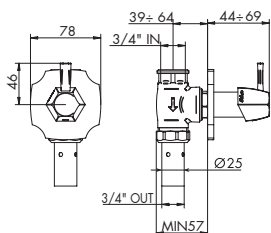

PASSO RAPIDO 3/4"

- > vitone tradizionale
- > abbinare a saracinesca
- > ingressi da 3/4"



PARTI ESTERNE - CROMATO

01-1440/E

PARTI ESTERNE - ALTRE FINITURE

XX-1440/E x M*

PARTE INCASSO

654099 info pag. 42

PREZZO TOTALE

1640/E + 654099 | SUITE

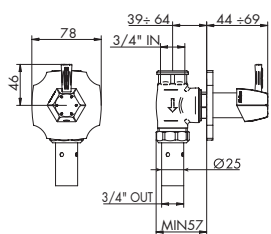

PASSO RAPIDO 3/4" C/SWAROVSKI

- > vitone tradizionale
- > abbinare a saracinesca
- > ingressi da 3/4"
- > maniglia e leva con SWAROVSKI



PARTI ESTERNE - CROMATO

01-1640/E

PARTI ESTERNE - ALTRE FINITURE

XX-1640/E x M*

PARTE INCASSO

654099 info pag. 42

PREZZO TOTALE

1740/E + 654099

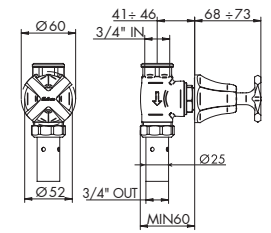

PASSO RAPIDO 3/4"

- > vitone tradizionale
- > abbinare a saracinesca
- > ingressi da 3/4"
- > maniglia a croce

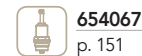

PARTI ESTERNE - CROMATO

01-1740/E

PARTI ESTERNE - ALTRE FINITURE

XX-1740/E x M*

PARTE INCASSO

654099 info pag. 42

PREZZO TOTALE

1840/E + 654099 | SUITE

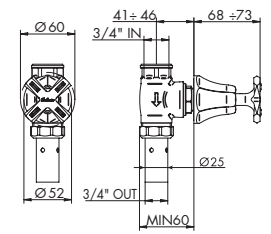

PASSO RAPIDO 3/4" C/SWAROVSKI

- > vitone tradizionale
- > abbinare a saracinesca
- > ingressi da 3/4"
- > maniglia a croce con SWAROVSKI



PARTI ESTERNE - CROMATO

01-1840/E

PARTI ESTERNE - ALTRE FINITURE

XX-1840/E x M*

PARTE INCASSO

654099 info pag. 42

PREZZO TOTALE

1440/E + 654100

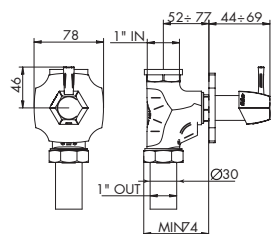

PASSO RAPIDO 1"

- > vitone tradizionale
- > abbinare a saracinesca
- > ingressi da 1"
- > maniglia e leva con SWAROVSKI



PARTI ESTERNE - CROMATO

01-1440/E

PARTE INCASSO

654100 info pag. 42

PREZZO TOTALE

PARTI ESTERNE - ALTRE FINITURE

XX-1440/E

x M*

1640/E + 654100 | SUITE

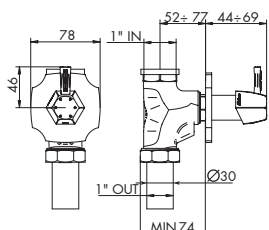

PASSO RAPIDO 1"

- > vitone tradizionale
- > abbinare a saracinesca
- > ingressi da 1"
- > maniglia e leva con SWAROVSKI



PARTI ESTERNE - CROMATO

01-1640/E

PARTE INCASSO

654100 info pag. 42

PREZZO TOTALE

PARTI ESTERNE - ALTRE FINITURE

XX-1640/E

x M*

1740/E + 654100

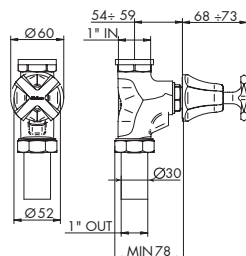

PASSO RAPIDO 1"

- > vitone tradizionale
- > abbinare a saracinesca
- > ingressi da 1"
- > maniglia a croce



PARTI ESTERNE - CROMATO

01-1740/E

PARTE INCASSO

654100 info pag. 42

PREZZO TOTALE

PARTI ESTERNE - ALTRE FINITURE

XX-1740/E

x M*

1840/E + 654100 | SUITE

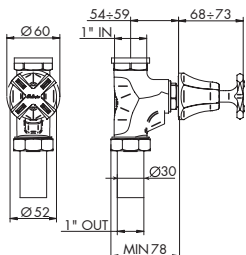

PASSO RAPIDO 1"

- > vitone tradizionale
- > abbinare a saracinesca
- > ingressi da 1"
- > maniglia a croce con SWAROVSKI



PARTI ESTERNE - CROMATO

01-1840/E

PARTE INCASSO

654100 info pag. 42

PREZZO TOTALE

PARTI ESTERNE - ALTRE FINITURE

XX-1840/E

x M*

1432/2/E + 035212

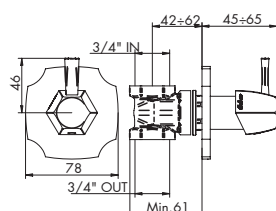

SARACINESCA

- > attacchi da 3/4"

PARTI ESTERNE - CROMATO

01-1432/2/E

PARTE INCASSO

035212 info pag. 42

PREZZO TOTALE

PARTI ESTERNE - ALTRE FINITURE

XX-1432/2/E

x M*

1632/2/E + 035212 | SUITE

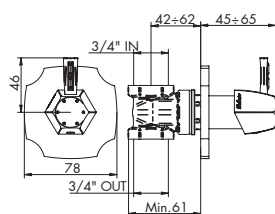

SARACINESCA C/SWAROVSKI

- > attacchi da 3/4"
- > maniglia e leva con SWAROVSKI

PARTI ESTERNE - CROMATO

01-1632/2/E

PARTE INCASSO

035212 info pag. 42

PREZZO TOTALE

PARTI ESTERNE - ALTRE FINITURE

XX-1632/2/E

x M*

1732/2/E + 035212

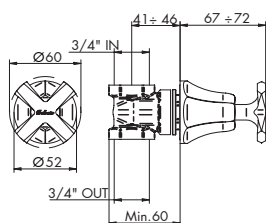

SARACINESCA

- > attacchi da 3/4"
- > maniglia a croce

PARTI ESTERNE - CROMATO

01-1732/2/E

PARTE INCASSO

035212 info pag. 42

PREZZO TOTALE

PARTI ESTERNE - ALTRE FINITURE

XX-1732/2/E

x M*

1832/2/E + 035212 | SUITE

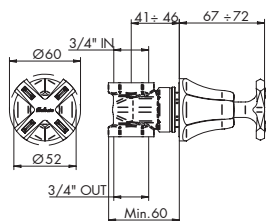

SARACINESCA C/SWAROVSKI

- > attacchi da 3/4"
- > maniglia a croce con Swarovsky

PARTI ESTERNE - CROMATO

01-1832/2/E

PARTE INCASSO

035212 info pag. 42

PREZZO TOTALE

PARTI ESTERNE - ALTRE FINITURE

XX-1832/2/E

x M*

