

SUPREME

WIDE
SUPERSIZE SLABS



LA SEDUZIONE DEL MARMO

esaltata dal grande formato

The seduction of marble in large sizes

FLAVIKER

CONTEMPORARY ECO CERAMICS

SUPREME

WIDE

SUPERSIZE SLABS

TECNOLOGIA AVANZATA
AL SERVIZIO DELL'ARCHITETTURA
CONTEMPORANEA

Advanced technology for contemporary architecture

FLAVIKER
CONTEMPORARY ECOCERAMICS



Flaviker's WIDE collection consists of tough yet lightweight porcelain slabs with a thickness of just 7 mm and a record size of 160x320 cm produced using the revolutionary CONTINUA+ technology. The new pressing system involves dry compaction of raw materials and is able to produce surfaces that combine excellent aesthetic quality with outstanding technical performance.



CERAMIC R-EVOLUTION

Il progetto WIDE Flaviker parte dalla rivoluzionaria tecnologia produttiva CONTINUA+, che permette di produrre lastre in gres porcellanato robuste e leggere allo stesso tempo, grazie allo spessore ridotto di 7mm, fino alla dimensione record di 160x320 cm. Il nuovo sistema di pressatura prevede la compattazione a secco delle materie prime e consente di ottenere superfici particolarmente apprezzabili sia per la qualità estetica che per le performance tecniche.

Otto colori di grande personalità estetica, dai “classici” marmi a varietà più rare e decorative, per una nuova interpretazione originale e non omologata di questo materiale dal fascino senza tempo.

WIDE
SUPERSIZE SLABS
COLOURS

Available in eight colours with powerful aesthetic appeal, from classic marble to rarer and more decorative varieties of stone, it offers a highly original interpretation of this timeless material.

EXOTIC BROWN

NOIR LAURENT

CALACATTA
EXTRA

ONYX
PRESTIGE

GREY AMANI

BLACK DELUXE

PURE STATUARIO

STATUARIO
VENATO

PURE
STATUARIO



Marmo, pietra, legno e superfici che richiamano i cementi industriali si mescolano tra loro dando vita a situazioni abitative e commerciali uniche e sorprendenti.

WIDE
SUPERSIZE SLABS

MULTIPLE SENSATIONS

Marble, stone, wood and surfaces inspired by industrial concrete are mixed to create unique, visually-striking residential and commercial spaces.

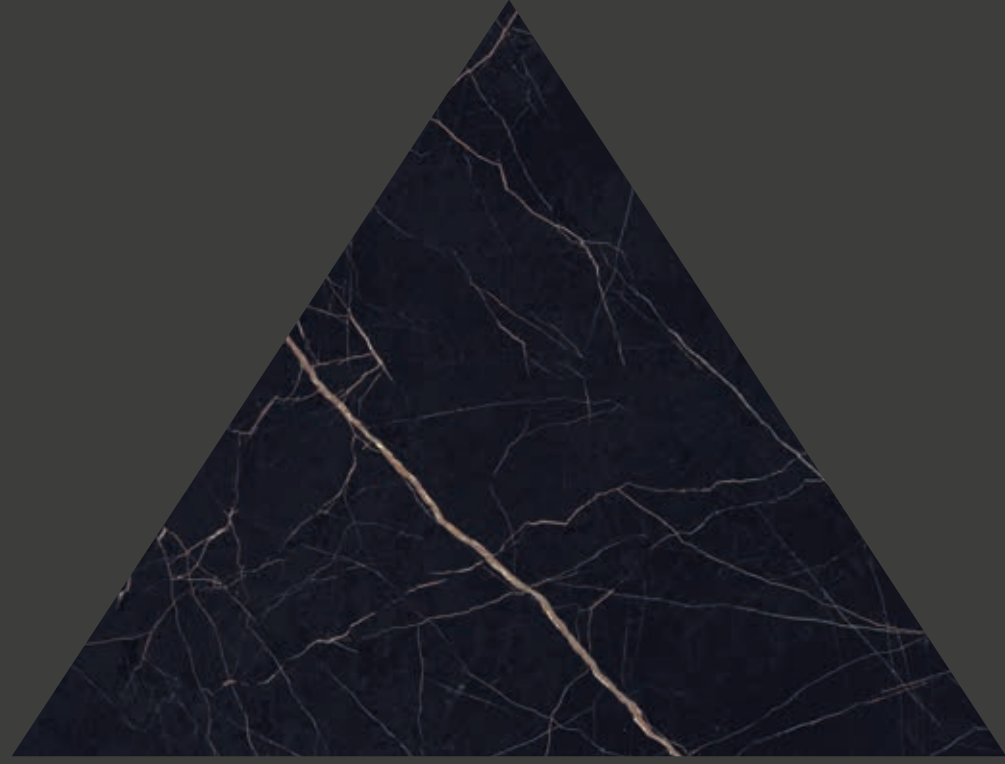

NOIR LAURENT



SUPREME NOIR LAURENT LUX+ 120x120-/CALACATTA EXTRA LUX+ 120x240



TRIANGOLO 30 **SUPREME** NOIR LAURENT LUX+ + TRIANGOLO 30 **COZY** HAVANA



SUPREME NOIR LAURENT LUX+ 120x140 **COZY** BROWN 20x120



STATUARIO VENATO



SUPREME BOOK MATCH STATUARIO VENATO LUX+ 120x240 **HYPHER** SILVER LUX+ 120x240 **SUPREME** STATUARIO VENATO LUX+ 120x120



SUPREME STATUARIO VENATO LUX+ 120x240 **HANGAR** 120x120



SUPREME STATUARIO VENATO LUX+ 120x240



GREY AMANI

SUPREME GREY AMANI RETT. 160x320





SUPREME GREY AMANI RETT. 160x320



SUPREME GREY AMANI LUX+ 60X120

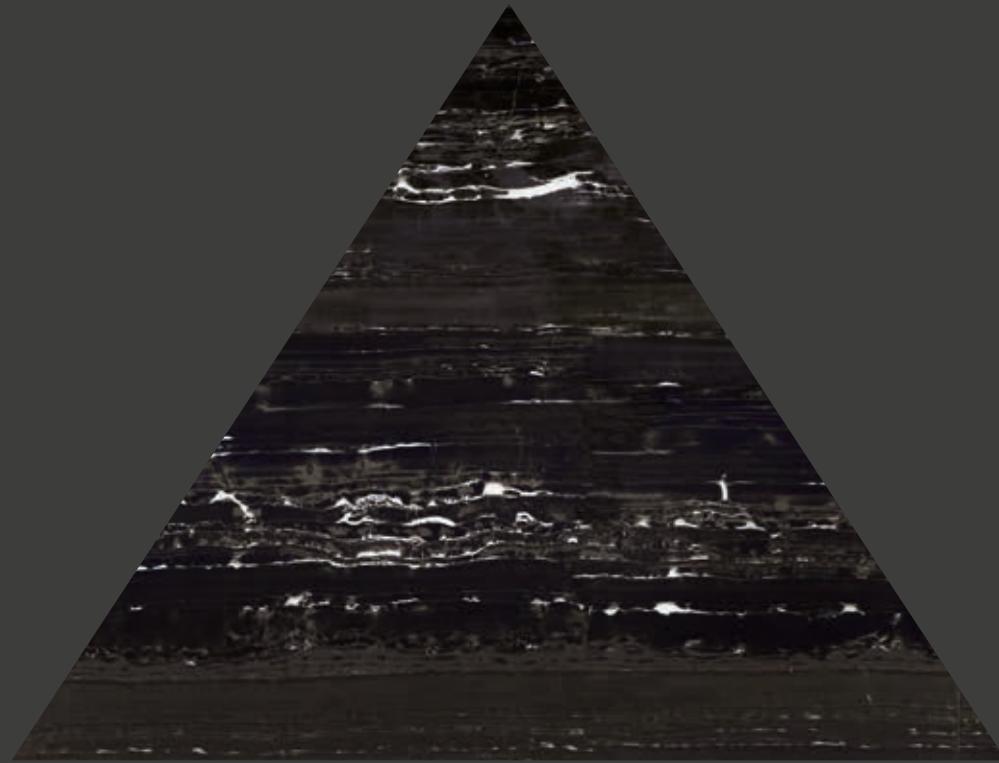

BLACK DELUXE



SUPREME BLACK DELUXE LUX+ 160x320 HANGAR SMOKE 160x320



SUPREME BLACK DELUXE LUX+ 160x320





SUPREME CALACATTA EXTRA LUX+ 160x320 / BLACK DELUXE LUX+ 160x320



SUPREME COMP. THREE BLACK DELUXE LUX+ / MAT. ALLUMINIO BRONZO 0,5x120



SUPREME COMP. THREE BLACK DELUXE LUX+ ON DEMAND **STILL_NO_W** SAND 160x160



PURE STATUARIO



SUPREME PURE STATUARIO LUX+ 160X320, 160X160, TRIANGOLO 30 / BLACK DELUXE LUX+ TRIANGOLO 30 / HANGAR SMOKE TRIANGOLO 30



SUPREME PURE STATUARIO LUX+, BLACK DELUXE LUX+ 160x320 **HANGAR** SMOKE 160x320
SUPREME PURE STATUARIO LUX+ 160x160, TRIANGOLO 30, TRIANGOLO BLACK DELUXE LUX+ **HANGAR** SMOKE TRIANGOLO 30



SUPREME PURE STATUARIO LUX+ 160x320 **HANGAR** SMOKE 160x320
SUPREME PURE STATUARIO LUX+ 160x160, TRIANGOLO 30, TRIANGOLO BLACK DELUXE LUX+ **HANGAR** SMOKE TRIANGOLO 30



SUPREME PURE STATUARIO RETT 80x80

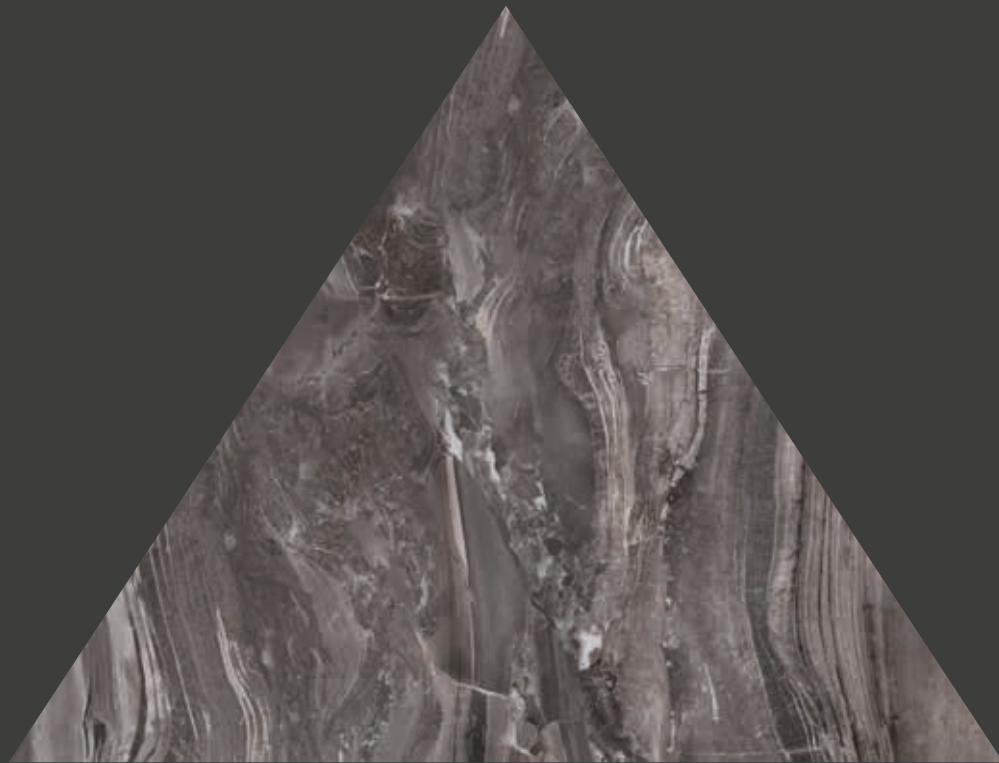

EXOTIC BROWN



SUPREME EXOTIC BROWN LUX+ 160x320



SUPREME EXOTIC BROWN LUX+ 160x320

SUPREME EXOTIC BROWN LUX+ 160x320 **STILL NO_W** COAL 160x320, TRIANGOLO 30





SUPREME EXOTIC BROWN LUX+ 160x320 **STILL NO_W** COAL 160x320, TRIANGOLO 30

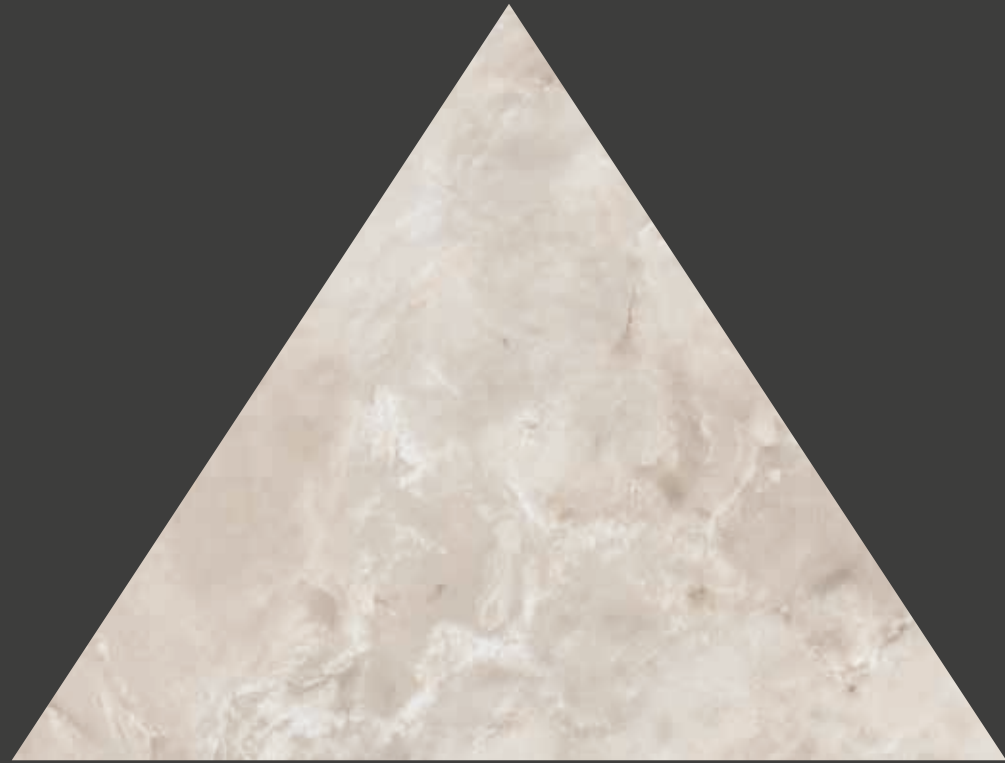

ONYX PRESTIGE

SUPREME ONYX PRESTIGE LUX+ 120x120 / MATITA ALLUMINIO BRONZO 0,5x120





SUPREME ONYX PRESTIGE LUX+ 120x240 **COZY** BROWN 26x200



SUPREME ONYX PRESTIGE LUX+ 120x240 **COZY** BROWN 26x200



CALACATTA EXTRA



SUPREME CALACATTA EXTRA LUX+ 120x240+120x120 STILL_NO_W SAND 120x240

SUPREME CALACATTA EXTRA LUX+ 120x240, 120x120 **STILL NO_W** SAND 120x240





SUPREME CALACATTA EXTRA LUX+ 120x240, 120x120 **STILL NO_W** SAND 120x240



SUPREME CALACATTA EXTRA BOOK MATCH LUX+ 120x240, CALACATTA EXTRA RETT. 160x320 (WALL AND COUNTERTOP KITCHEN) **COZY** HONEY 20x120





160x320

NOIR LAURENT

160x320 LUX*	0002479
160x320 RETT.	0003182
160x160 LUX*	0002489
120x240 LUX*	0002495
120x120 LUX*	0002508
60x120 LUX*	0002511

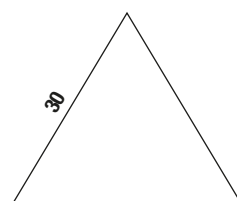





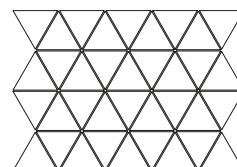



0002514
TRIANGOLO 30 NOIR LAURENT LUX* RETT.

34x26



0002528
MOS. TRIANGOLI NOIR LAURENT LUX*









	Battiscopa LUX* 5,5x120 	0002516
	Gradone Plus LUX* 32x120x4,5x1,5 	0002519
	Ang. Plus sx LUX* 32x120x4,5x1,5 	0002522
	Ang. Plus dx LUX* 32x120x4,5x1,5 	0002525

STATUARIO VENATO



160x320

160x320 LUX*	0002481
160x320 RETT.	0002756
160x160 LUX*	0002491
120x240 LUX*	0002497
120x120 LUX*	0002510
60x120 LUX*	0002513

	Battiscopa LUX* 5,5x120 	0002518
	Gradone Plus LUX* 32x120x4,5x1,5 	0002521
	Ang. Plus sx LUX* 32x120x4,5x1,5 	0002524
	Ang. Plus dx LUX* 32x120x4,5x1,5 	0002527



160x320

GREY AMANI

160x320 LUX*	0002480
160x320 RETT.	0002765
160x160 LUX*	0002490
120x240 LUX*	0002496
120x120 LUX*	0002509
60x120 LUX*	0002512

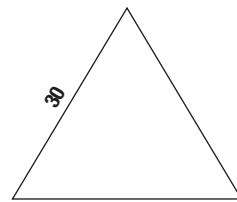

0002515
TRIANGOLO 30 GREY AMANI LUX* RETT.

34x26

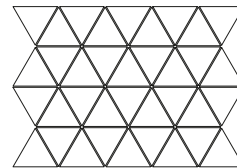

0002529
MOS. TRIANGOLI GREY AMANI LUX*

	Battiscopa LUX+ 5,5x120	0002517
	Gradone Plus LUX+ 32x120x4,5x1,5	0002520
	Ang. Plus sx LUX+ 32x120x4,5x1,5	0002523
	Ang. Plus dx LUX+ 32x120x4,5x1,5	0002526

BLACK DELUXE



160x320

160x320 LUX*	0000401
160x160 LUX*	0000404
120x240 LUX*	0000407
120x120 LUX*	0000410
60x120 LUX*	0000935

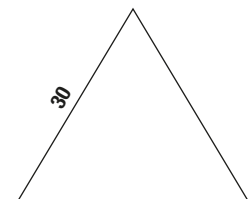

0000415
TRIANGOLO 30 BLACK DELUXE LUX* RETT.

34x26

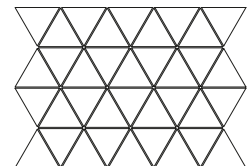

0000998
MOS. TRIANGOLI BLACK DELUXE LUX*

	Battiscopa LUX+ 5,5x120	0000938
	Gradone Plus LUX+ 32x120x4,5x1,5	0000941
	Ang. Plus sx LUX+ 32x120x4,5x1,5	0000944
	Ang. Plus dx LUX+ 32x120x4,5x1,5	0000947



160x320

PURE STATUARIO

160x320 LUX*	0000371
160x160 LUX*	0000377
120x240 LUX*	0000383
120x120 LUX*	0000389
80x160 RETT.	0000735
80x80 LUX*	0000718
80x80 RETT.	0000739

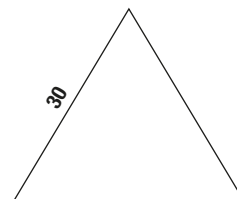

0000413
TRIANGOLO 30 PURE STATUARIO LUX* RETT.
126

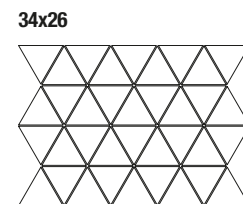

0000996
MOS. TRIANGOLI PURE STATUARIO LUX*
5

	Battiscopa LUX+ 5,5x120	6	0000871
	Gradone Plus LUX+ 32x120x4,5x1,5	1	0000877
	Ang. Plus sx LUX+ 32x120x4,5x1,5	1	0000883
	Ang. Plus dx LUX+ 32x120x4,5x1,5	1	0000889

EXOTIC BROWN

160x320 LUX*	0000399
160x160 LUX*	0000402
120x240 LUX*	0000405
120x120 LUX*	0000408

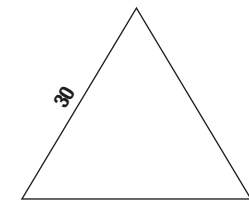

0000411
TRIANGOLO 30 EXOTIC BROWN LUX* RETT.
126

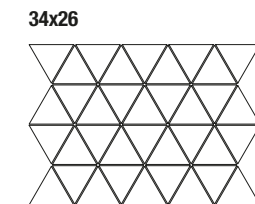

0000994
MOS. TRIANGOLI EXOTIC BROWN LUX*
5



160x320

	Battiscopa LUX+ 5,5x120	6	0000936
	Gradone Plus LUX+ 32x120x4,5x1,5	1	0000939
	Ang. Plus sx LUX+ 32x120x4,5x1,5	1	0000942
	Ang. Plus dx LUX+ 32x120x4,5x1,5	1	0000945



160x320

ONYX PRESTIGE



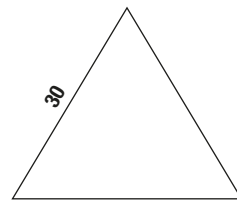



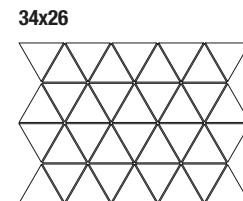

160x320 LUX+	0000400
160x160 LUX+	0000403
120x240 LUX+	0000406
120x120 LUX+	0000409

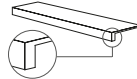

0000414
TRIANGOLO 30 ONYX PRESTIGE LUX+ RETT.



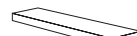

34x26
0000997
MOS. TRIANGOLI ONYX PRESTIGE LUX+

	Battiscopa LUX+ 5,5x120		0000937
	Gradone Plus LUX+ 32x120x4,5x1,5		0000940
	Ang. Plus sx LUX+ 32x120x4,5x1,5		0000943
	Ang. Plus dx LUX+ 32x120x4,5x1,5		0000946

CALACATTA EXTRA

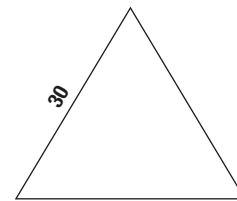





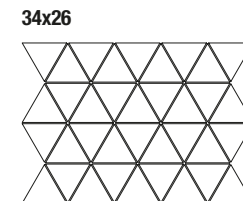

160x320 LUX+	0000367
160x320 rett.	0002751
160x160 LUX+	0000373
120x240 LUX+	0000379
120x120 LUX+	0000385
80x160 RETT.	0000732
80x80 LUX+	0000717
80x80 RETT.	0000736

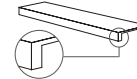

0000412
TRIANGOLO 30 CALACATTA EXTRA LUX+ RETT.

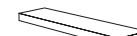

34x26
0000995
MOS. TRIANGOLI CALACATTA EXTRA LUX+

	Battiscopa LUX+ 5,5x120		0000867
	Gradone Plus LUX+ 32x120x4,5x1,5		0000873
	Ang. Plus sx LUX+ 32x120x4,5x1,5		0000879
	Ang. Plus dx LUX+ 32x120x4,5x1,5		0000885



160x320

SLAB A

SLAB B



CALACATTA EXTRA

SLAB A

120x240 LUX* 0001127

SLAB B

120x240 LUX* 0001128

01.1 2 colori

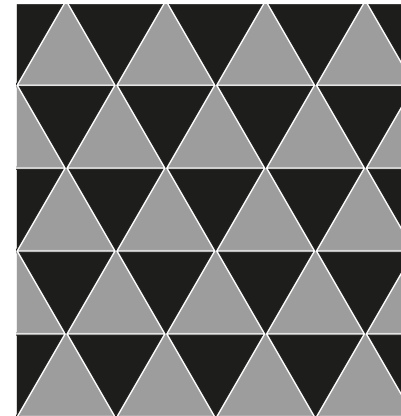

COLOR 1 50% ■
COLOR 2 50% ■

01.2 2 colori

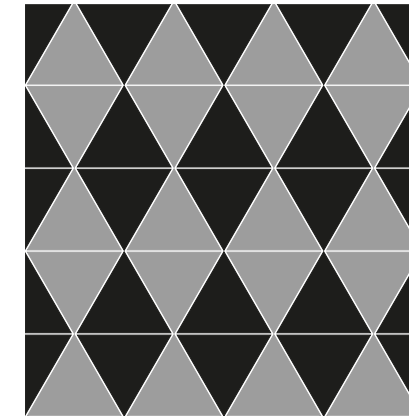

COLOR 1 50% ■
COLOR 2 50% ■

01.3 2 colori

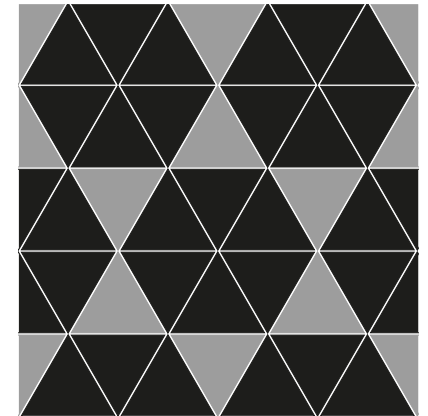

COLOR 1 75% ■
COLOR 2 25% ■

01.4 2 colori

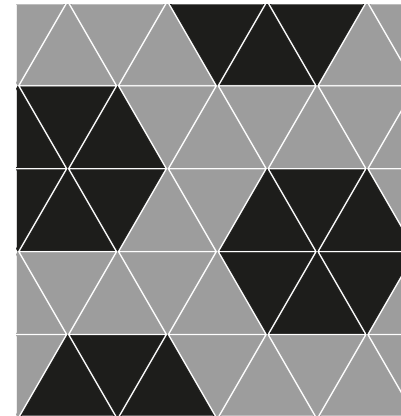

COLOR 1 57% ■
COLOR 2 43% ■

01.5 3 colori

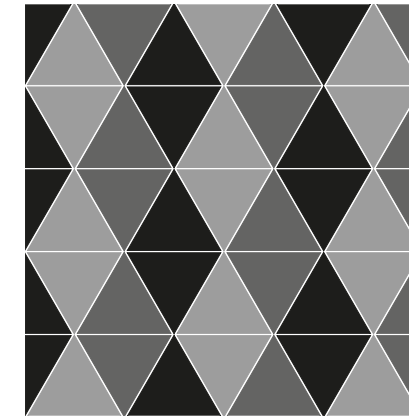

COLOR 1 33,33% ■ COLOR 3 33,33% ■
COLOR 2 33,33% ■

01.6 3 colori

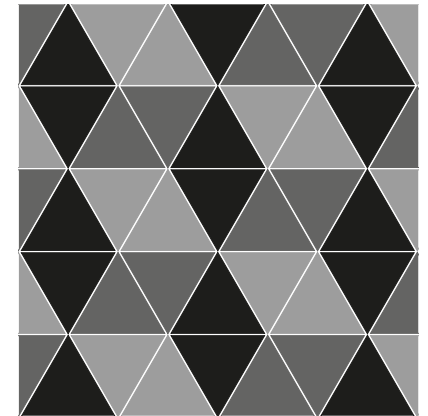

COLOR 1 33,33% ■ COLOR 3 33,33% ■
COLOR 2 33,33% ■

SLAB A

SLAB B

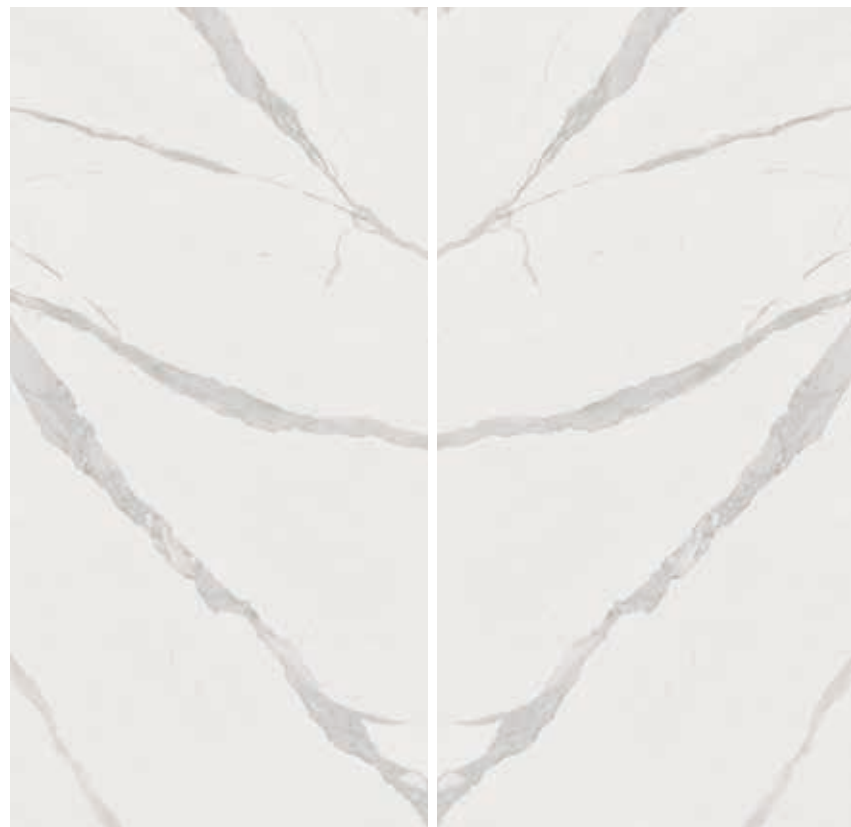

STATUARIO VENATO

SLAB A

120x240 LUX* 0002500

SLAB B

120x240 LUX* 0002501

01.7 3 colori

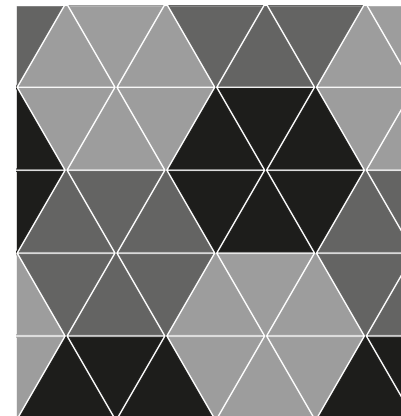

COLOR 1 33,33% ■ COLOR 3 33,33% ■
COLOR 2 33,33% ■

01.8 4 colori

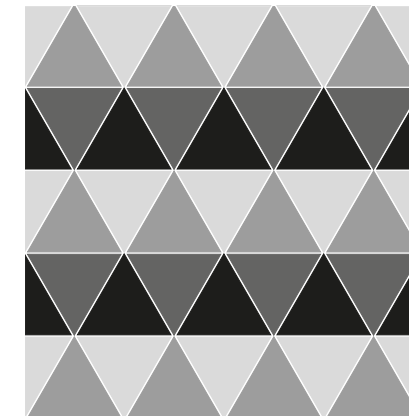

COLOR 1 25% ■ COLOR 3 25% ■
COLOR 2 25% ■ COLOR 4 25% ■

02 2 colori

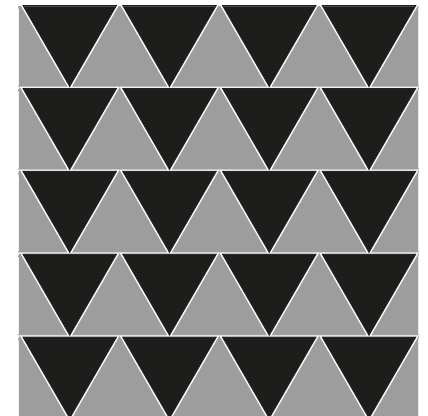

COLOR 1 50% ■
COLOR 2 50% ■

0,5x120 0000086 MATITA ALLUMINIO



0,5x120 0000088 MATITA ALLUMINIO BLACK



0,5x120 0000557 MATITA ALLUMINIO BRONZO



0,5x120 0000087 MATITA ALLUMINIO WHITE



0,5x120 0000556 MATITA ALLUMINIO RAME



Articoli realizzati in alluminio per l'uso a parete, adatti a raccordare piastrelle di diverso spessore (9 mm / 7 mm).

Aluminium strip for use between wall tiles of different thicknesses (9 mm / 7 mm).



ESEMPIO DI APPLICAZIONE ON DEMAND
EXAMPLE OF ON DEMAND INSTALLATION

COMPOSIZIONI DECORATIVE DECORATIVE COMPOSITIONS

Con un occhio attento alla decorazione di interni, FLAVIKER propone composizioni grafiche realizzate a idrogetto sulle lastre ceramiche in 7 mm. Le fughe, se esaltate con stucchi a contrasto, diventano motivo decorativo. Questi soggetti sono disponibili nel formato 120x240 cm, oppure adattabili a qualsiasi misura richiesta con il servizio ON DEMAND. Il cliente dovrà fornire le esatte dimensioni della superficie da rivestire; verrà poi realizzato un disegno esecutivo con relativo preventivo. Ogni singolo pezzo che compone il soggetto verrà numerato in modo da facilitare le operazioni di posa. Fuga tra i diversi pezzi 2 mm.

With a keen eye for interior decoration, FLAVIKER offers design compositions created from waterjet-cut 7 mm thick ceramic slabs. Contrasting coloured grout can be used to enhance the joints and create a decorative pattern. These designs are available in 120x240 cm slabs or can be adapted to surfaces of any size using the ON DEMAND service. The customer will need to provide the exact dimensions of the surface to be tiled, after which a detailed drawing and quote can be made. Each piece making up the design will be numbered for ease of installation. A 2 mm joint will be maintained between the individual tiles.

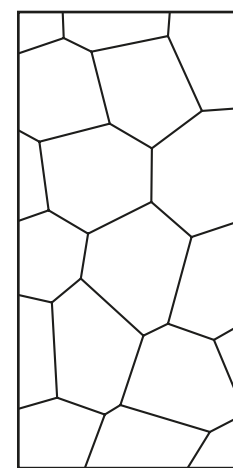

PEBBLE COMP. 120x240

EXOTIC BROWN LUX+	0000987
BLACK DELUXE LUX+	0000991
PURE STATUARIO LUX+	0000989
ONYX PRESTIGE LUX+	0000990
CALACATTA EXTRA LUX+	0000988

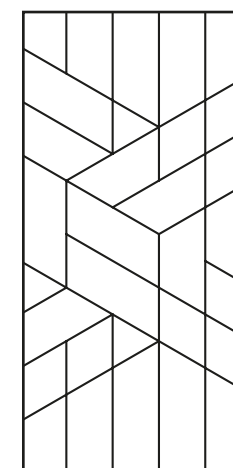

TETRIS COMP. 120x240

EXOTIC BROWN LUX+	0000982
BLACK DELUXE LUX+	0000986
PURE STATUARIO LUX+	0000984
ONYX PRESTIGE LUX+	0000985
CALACATTA EXTRA LUX+	0000983

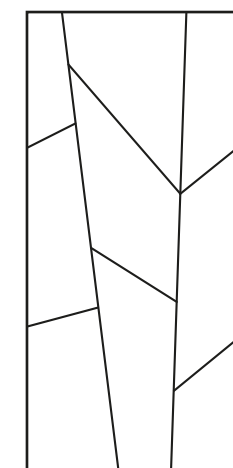

THREE COMP. 120x240

EXOTIC BROWN LUX+	0000977
BLACK DELUXE LUX+	0000981
PURE STATUARIO LUX+	0000979
ONYX PRESTIGE LUX+	0000980
CALACATTA EXTRA LUX+	0000978

COD. PER IL SERVIZIO SU MISURA ON DEMAND / ON DEMAND SERVICE CODE: 0000100

ESEMPI DI APPLICAZIONE EXAMPLES OF APPLICATION

COMP. 120X240

Consigliata per posa a pezzo singolo
Recommended for single-piece installation

Altezza soffitto 400 cm, Altezza posa 240 cm

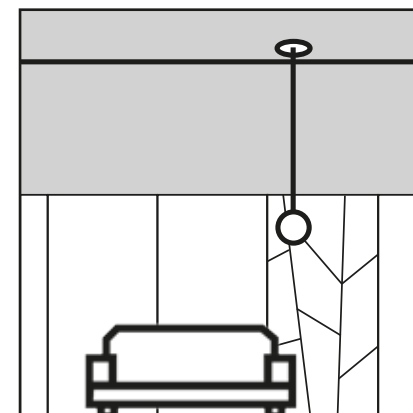

ON DEMAND

Es. Posa alt. 240 cm in tutta la parete
Ex. Laying 240 cm height throughout the length of the wall

Altezza soffitto 400 cm, Altezza posa 240 cm

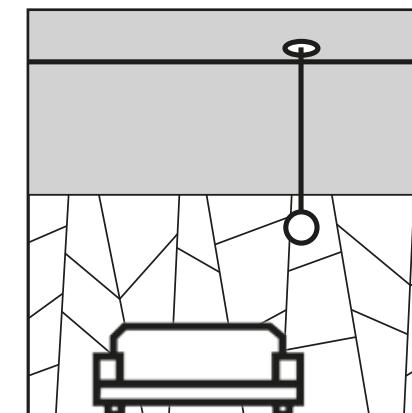

ON DEMAND

Es. Posa a tutta parete
Ex. Laying full height tiles

Altezza soffitto 400 cm, Altezza posa 400 cm

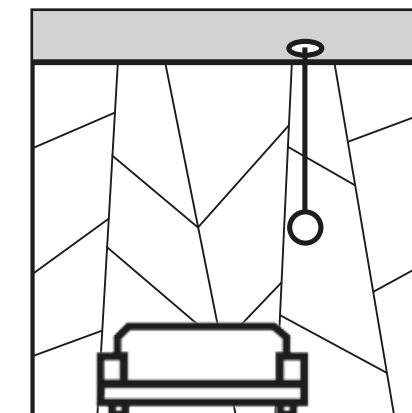

WIDE

LITE
7 MM THICKNESS
STRONG
CONTINUA+ DRY COMPACTION

SUPERSIZE SLABS

CERAMIC R-EVOLUTION

Il progetto WIDE FLAVIKER parte dalla rivoluzionaria tecnologia produttiva CONTINUA+, che permette di produrre lastre in gres porcellanato robuste e leggere allo stesso tempo, grazie allo spessore ridotto di 7mm, fino alla dimensione record di 160x320 cm. Il nuovo sistema di pressatura prevede la compattazione a secco delle materie prime e consente di ottenere superfici particolarmente apprezzabili sia per la qualità estetica che per le performance tecniche.

FLAVIKER's WIDE collection consists of tough yet lightweight porcelain slabs with a thickness of just 7 mm and a record size of 160x320 cm produced using the revolutionary CONTINUA+ technology. The new pressing system involves dry compaction of raw materials and is able to produce surfaces that combine excellent aesthetic quality with outstanding technical performance.



WIDE & STRONG

WIDE è perfettamente idoneo sia per il rivestimento che per la pavimentazione, in ambito residenziale e commerciale. Lo spessore 7 mm consente di mantenere un'ottima resistenza al carico di rottura reale.

WIDE is ideal as both a floor and wall covering in residential and commercial projects. The 7 mm thickness enables it to maintain excellent breaking strength in real situations.

CARICO DI ROTTURA BREAKING STRENGTH

FLAVIKER 9 mm = 1.662 newton
FLAVIKER 7mm = 1.587 newton
Altri 6 mm = 1.166 newton

PESO WEIGHT

FLAVIKER 9 mm = 19,5 Kg x mq
FLAVIKER 7 mm = 17,5 Kg x mq

NEW DIMENSIONS

Uno degli obiettivi del progetto WIDE è quello di fornire un materiale ceramico tecnologicamente avanzato facilmente utilizzabile in contesti anche molto diversi, per dimensione e per destinazione d'uso. WIDE è un vero e proprio programma di formati, tutti rettificati, pensati per coprire a 360° le esigenze legate alla progettazione, a partire dagli spazi residenziali, fino alle grandi opere in ambito pubblico e commerciale.

One of the aims of the WIDE project is to supply a hi-tech ceramic material that is easy to use in very different sizes and applications. WIDE comes in a large selection of sizes, all rectified, ideal for uses ranging from residential through to large-scale works in public and commercial spaces.

EVERYWHERE YOU LIKE

Tenendo conto delle principali qualità del materiale, tra cui la robustezza, la resistenza agli sbalzi termici, oltre allo spessore contenuto e alla facilità di lavorazione, le grandi lastre WIDE ampliano la destinazione d'uso del gres porcellanato. Sempre meno fughe e sempre più spazio alla creatività di progettisti e interior designers, che grazie ai prodotti WIDE possono apprezzare la versatilità di una ceramica senza più confini.

Taking account of the material's key qualities, including strength, thermal shock resistance, low thickness and ease of working, the WIDE large-size slabs extend the fields of use of porcelain. The WIDE collection has fewer joints while giving enormous creative freedom to architects and interior designers, who appreciate the versatility of this ceramic surface without limits.



PAVIMENTI INTERNI
INDOOR FLOORS



RIVESTIMENTI INTERNI
INDOOR WALLS

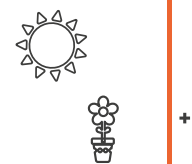

FACCIADE ESTERNE
INCOLLATE E VENTILATE
GLUED AND VENTILATED
EXTERIOR FAÇADES

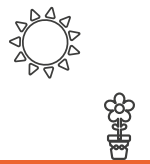

PAVIMENTI AREE ESTERNE
OUTDOOR FLOORS



PIANI LAVORO CUCINE
KITCHEN COUNTERTOPS



TOP E FINITURE PER AMBIENTI
BAGNO
BATHROOM VANITY TOPS AND
SHELVES



ELEMENTI DI ARREDO E DESIGN
PER INTERNI
INTERIOR FURNISHING AND
DESIGN ELEMENTS

F.to nominale Nominal size	F.to reale (mm) Work size (mm)	Spessore Thickness	Tipologia imballo Type of packing	Lastre/Imballo Slabs/Packing	Pz/Imballo Pcs/Packing	Mq/Scatola Sqm/Box	Kg/Scatola Kg/Box	Scatole/ Imballo Box/Packing	Mq totali Sqm total	Kg/Imballo Kg/Packing	Kg totali Kg total
160x320 / 64"x128" RETT/LUX*	1596,5x3195	7 mm	Cassa Crate	15	-	-	-	-	76,80	139	1.483
			Cavalletto container Container Rack pallet	36	-	-	-	-	184,32	180	3.406
120x240 / 48"x96" LUX*	1194x2390	7mm	Cavalletto Rack pallet	40	-	-	-	-	115,20	100	2.116
			Cassa Crate	20	-	-	-	-	57,60	100	1.108
			Cavalletto container Container Rack pallet	40	-	-	-	-	115,20	115	2.131
			Cassa Crate	15	-	-	-	-	38,40	75	747
160x160 / 64"x64" LUX*	1596,5x1596,5	7 mm	Cassa Crate	30	-	-	-	-	76,80	139	1.483
			Cavalletto container Container Rack pallet	36	-	-	-	-	92,16	95	1.708
80x160 / 32"x64" RETT	797,25x1596,5	7 mm	Cavalletto Rack pallet	56	2	2,56	44,80	28	71,68	70	1.325
			Pallet con sponde Pallet with sides	56	2	2,56	44,80	28	71,68	40	1.295
120x120 / 48"x48" LUX*	1194x1194	7 mm	Cavalletto Rack pallet	56	2	2,88	50,40	28	80,64	70	1.481
			Pallet con sponde Pallet with sides	44	2	2,88	50,40	22	63,36	40	1.149
60x120 / 48"x48" LUX*	596x1194	7 mm	Pallet	81	3	2,16	36,00	27	58,32	-	988
80x80 / 32"x32" RETT/LUX*	797,25x797,25	7 mm	Pallet	120	3	1,92	33,60	40	76,80	-	1.359

I pezzi speciali, per effetto delle lavorazioni, possono presentare variazioni di tonalità. Due to working process, special trims may show variations in tonality. L'unità minima di vendita per tutti gli articoli (fondi, decori e pezzi speciali) è la scatola completa. The minimum sales quantity for all items (plain tiles, decorations and special trims) is one full box. I dati relativi agli imballi sono aggiornati al momento della stampa del catalogo e pertanto possono subire variazioni nel corso del tempo. Data referring to packaging have been update at time of printing; the actual data may be slightly different.

LASTRE IN GRES PORCELLANATO PORCELAIN SLABS

CLASSIFICAZIONE SECONDO NORME UNI EN 14411 (ISO 13006) ALLEGATO G-Gruppo Bla
CLASSIFICATION IN ACCORDANCE WITH UNI EN 14411 (ISO 13006) ANNEX G-Group Bla

PROPRIETÀ FISICO-CHIMICHE PHYSICAL-CHEMICAL PROPERTIES	NORMA NORM	VALORE PRESCRITTO DALLE NORME VALUE PRESCRIBED FROM THE NORMS	VALORE FLAVIKER FLAVIKER VALUE NATURALE / NATURAL
RESISTENZA ALLO SCIVOLAMENTO SLIP RESISTANCE	B.C.R.A. C.A.	μ 0,19 SCIVOLOSITÀ PERICOLOSA - DANGEROUSLY SLIPPERY $0,20 < \mu < 0,39$ SCIVOLOSITÀ ECCESSIVA - EXCESSIVELY SLIPPERY $0,40 < \mu < 0,74$ ATTRITO SODDISFACENTE - SATISFACTORY GRIP μ 0,75 ATTRITO ECCELLENTE - EXCELLENT GRIP	>0,40
	B.C.R.A. G.B.		
RESISTENZA ALLO SCIVOLAMENTO SLIP RESISTANCE	ASTM C 1028 (S.C.O.F.)	SLIP RESISTANT (> 0,60)	>0,60 DRY >0,60 WET
	DIN 51130	IN FUNZIONE DELL'AMBIENTE O DELLA ZONA DI LAVORO BASING ON THE ENVIRONMENT OR THE WORKING AREA	R9

VARIAZIONE CROMATICA SHADE VARIATION	V3	aspetto uniforme uniform appearance V1	lieve variazione slight variation V2	moderata variazione moderate variation V3	forte variazione substantial variation V4
---	----	--	--	---	---

FLAVIKER-PI.SA

BRAND OF ABK GROUP INDUSTRIE CERAMICHE S.P.A.
S.S. 569 per Vignola, 226
41014 Solignano di Castelvetro (Mo) Italy
T +39 (0) 59 9752011
F +39 (0) 59 9752010

flavikerpisa.it
#flaviker



La riproduzione dei colori è approssimativa.
Colour reproduction approximate.



