



Technical Accessories

Technical Accessories

TE 705



IT Micelatore termostatico per sotto scaldabagno da 1/2"
 DE Thermostat 1/2" für Boilerregulierung
 FR Migeur thermostatique pour chauffe-eau 1/2"
 EN 1/2" thermostatic heater mixer
 ES Termostato para inferior de 1/2"
 RU Термостатический смеситель под котел 1/2"

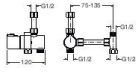

51 cromato

PCR11713000

AC 893



IT Tubo a S per sifone lavabo e bidet
 DE S-Rohr für Geruchverschluss für Waschtisch und Bidet
 FR Tube S pour siphon lavabo/bidet
 EN S tube for bidet/basin siphon
 ES Tubo a S para sifon lavabo y bidé
 RU S-образная труба для сифона раковины и биде

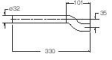

51 cromato

AC 900



IT Coppia tappi copriforo per lavabo/bidet
 DE Stopfen für Keramikloch Waschtisch/Bidet
 FR Paire de bouchon cache-trou pour lavabo/bidet
 EN Cover plugs for bidet/wash basin (pair)
 ES Juego de tapones cubre-orificios para lavabo/bidé
 RU Пара крышек для отверстия для раковины/биде



51 cromato

AC 599



IT Basetta d'appoggio per lavabo in ceramica
 DE Sockel für Keramik-Waschtisch
 FR Base d'appui pour lavabo en céramique
 EN Lean base for ceramic wash basin
 ES Base de apoyo para lavabo cerámica
 RU Опорная база для раковины из керамики



51 cromato

51 cromato-chrome / 00 grigio-raw / 02 bianco-white / 03 luce blu-light blue / 06 luce bianca-light white / 13 nero opaco-black mat / 24 bianco opaco-white mat / 28 inox-stainless steel
 34 oro oro spazzolato-brushed rose gold / 44 oro oro lucido-polished rose gold / 52 oro giallo-yellow gold / 53 ottone naturale-natural brass / 72 ottone nero lucido-polished black chrome
 75 ottone nero spazzolato-brushed black chrome / 77 metallo spazzolato-brushed metal / 80 metallo lucido-polished metal / 86 sfumato-shaded / 92 ottone antico spazzolato-brushed old brass

Technical Accessories

AC 579 new



IT Supporto scorrevole per asta saliscendi ø20 - ø20,6 mm
 DE Gleitchieber für Brausewandstange ø20 - ø20,6 mm
 FR Curseur réglable pour barre de douche ø20 - ø20,6 mm
 EN Slide rail for ø20 - ø20,6 mm sliding bar
 ES Soporte deslizante para barra deslizante de ø20 - ø20,6 mm
 RU Направляющая для ø20 - ø20,6 мм скользящая штанга



51 cromato

AC 849



IT Piletta per lavabo da 1"1/4 con tappo e catenella
 DE Ablaufventil 1"1/4 mit Kette und Stopfen für Waschtisch
 FR Bonde lavabo 1"1/4 avec bouchon chaînette
 EN 1"1/4 wash basin waste with chain and plug
 ES Piletta para lavabo de 1"1/4 con tapón y cadénilla
 RU Сток для раковины 1"1/4 с пробкой и цепочкой



51 cromato 52 oro giallo 92 ottone antico spazzolato

AC 850



IT Piletta per livello cucina da 1"1/2 con tappo e catenella
 DE Ablaufventil 1"1/2 mit Kette und Stopfen für Spültisch
 FR Bonde évier de cuisine 1"1/2 avec bouchon chaînette
 EN 1"1/2 kitchen sink waste with chain and plug
 ES Piletta para cocina de 1"1/2 con tapón y cadénilla
 RU Сток для кухонной мойки 1"1/2 с пробкой и цепочкой



51 cromato 52 oro giallo 92 ottone antico spazzolato

AC 825



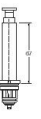

IT Insieme deviatore per CS 535 funzionamento alte pressioni (da 3 a 6 bar)
 DE Umsteller komplett für CS 535 für Hochdruck (vom 3 bis 6 bar)
 FR Ensemble inverseur CS 535 pour haute pression (entre 3 et 6 bar)
 EN Diverter kit for CS 535 for high pressure (3 to 6 bar)
 ES Desviador para CS 535 alta presión (de 3 a 6 bar)
 RU Переключатель в сборе для CS 535 для работы с высоким расходом (от 3 до 6 бар)







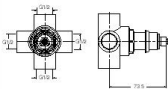

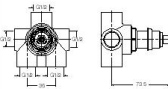
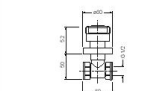
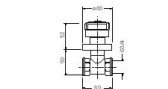
51 cromato

51 cromato-chrome / 00 grigio-raw / 02 bianco-white / 03 luce blu-light blue / 06 luce bianca-light white / 13 nero opaco-black mat / 24 bianco opaco-white mat / 28 inox-stainless steel
 34 oro oro spazzolato-brushed rose gold / 44 oro oro lucido-polished rose gold / 52 oro giallo-yellow gold / 53 ottone naturale-natural brass / 72 ottone nero lucido-polished black chrome
 75 ottone nero spazzolato-brushed black chrome / 77 metallo spazzolato-brushed metal / 80 metallo lucido-polished metal / 86 sfumato-shaded / 92 ottone antico spazzolato-brushed old brass

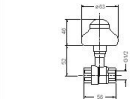
Technical Accessories

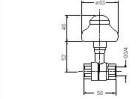
<p>AC 383</p> 	<p>IT: Deviatore 2 uscite broccia 8/20 DE: 2 Wege Umsteller Verzahnung 8/20 FR: Inverseur 2 sorties broches 8/20 dents EN: 2 outlets diverter - 8/20 mark ES: Desviador 2 salidas 8/20 RU: Переключатель на 2 выхода проточки 8/20</p> 
<p>AC 385</p> 	<p>IT: Deviatore 3 uscite broccia 8/20 DE: 3 Wege Umsteller Verzahnung 8/20 FR: Inverseur 3 sorties broches 8/20 dents EN: 3 outlets diverter - 8/20 mark ES: Desviador 3 salidas 8/20 RU: Переключатель на 3 выхода проточки 8/20</p> 
<p>AC 620</p>	<p>IT: Rubinetto d'arresto da 1/2" DE: Absperrventil 1/2" FR: Robinet d'arrêt 1/2" EN: 1/2" stopcock ES: Llave de cierre de 1/2" RU: Запорный кран 1/2"</p> 
<p>AC 621</p>	<p>IT: Rubinetto d'arresto da 3/4" DE: Absperrventil 3/4" FR: Robinet d'arrêt 3/4" EN: 3/4" stopcock ES: Llave de cierre de 3/4" RU: Запорный кран 3/4"</p> 

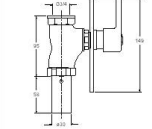
Technical Accessories

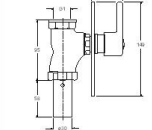
<p>AC 800</p> 	<p>IT: Rubinetto d'arresto ad incasso da 1/2" con cappuccio 2 pezzi DE: Unterputz Absperrventil 1/2" mit zweiteiliger Abdeckkappe FR: Robinet d'arrêt encastré 1/2" avec couvercle 2 pièces EN: 1/2" concealed stopcock with cap ES: Llave de cierre empotrada de 1/2" con tapa de 2 piezas RU: Встраиваемый стопорный кран 1/2" с колпачком, 2 шт.</p> 
<p>AC 801</p> 	<p>IT: Rubinetto d'arresto ad incasso da 3/4" con cappuccio 2 pezzi DE: Unterputz Absperrventil 3/4" mit zweiteiliger Abdeckkappe FR: Robinet d'arrêt encastré 3/4" avec couvercle 2 pièces EN: 3/4" concealed stopcock with cap ES: Llave de cierre empotrada de 3/4" con tapa de 2 piezas RU: Встраиваемый стопорный кран 3/4" с колпачком, 2 шт.</p> 
<p>AC 809</p> 	<p>IT: Passo rapido a incasso da 3/4" DE: Unterputz-Spüler 3/4" FR: Robinet rincour encastré 3/4" EN: 3/4" concealed W/C flush ES: Llave empotrada de 3/4" RU: Встраиваемый смеситель 3/4"</p> 
<p>AC 810</p> 	<p>IT: Passo rapido a incasso da 1" DE: Unterputz-Spüler 1" FR: Robinet rincour encastré 1" EN: 1" concealed W/C flush ES: Llave empotrada de 1" RU: Встраиваемый смеситель 1"</p> 

644 51 cromato-cromato / 00 grigio-raw / 02 bianco-white / 03 luce blu-light blue / 06 luce bianca-light white / 13 nero opaco-black mat / 24 bianco opaco-white mat / 28 inox-stainless steel / 34 oro oro spazzolato-brushed rose gold / 44 oro oro lucido-polished rose gold / 52 oro giallo-yellow gold / 53 ottone naturale-natural brass / 72 ottone nero lucido-polished black chrome / 75 ottone nero spazzolato-brushed black chrome / 77 metallo spazzolato-brushed metal / 80 metallo lucido-polished metal / 86 sfumato-shaded / 92 ottone antico spazzolato-brushed old brass

51 cromato-cromato / 00 grigio-raw / 02 bianco-white / 03 luce blu-light blue / 06 luce bianca-light white / 13 nero opaco-black mat / 24 bianco opaco-white mat / 28 inox-stainless steel / 34 oro oro spazzolato-brushed rose gold / 44 oro oro lucido-polished rose gold / 52 oro giallo-yellow gold / 53 ottone naturale-natural brass / 72 ottone nero lucido-polished black chrome / 75 ottone nero spazzolato-brushed black chrome / 77 metallo spazzolato-brushed metal / 80 metallo lucido-polished metal / 86 sfumato-shaded / 92 ottone antico spazzolato-brushed old brass

Technical Accessories

AC 798



IT: Passo rapido esterno con tubo a L da 1"
 DE: Spülrei mit L-förmigem Rohr 1"
 FR: Robinet riscar extérieur avec tube à L 1"
 EN: External WC flush with 1" L pipe
 ES: Llave empotrada con tubo a L de 1"
 RU: Наружный кран с L-образной трубой 1"

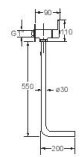

51 cromato

AC 167



IT: Piastra copriflono a pavimento ø 15 cm
 DE: Abdeckplatte für Bodensiphon ø 15 cm
 FR: Plaque couvre siphon au sol ø 15 cm
 EN: ø 15 cm floor siphon cover plate
 ES: Flator cubre sifón a pavimento diam. 15 cms
 RU: Напольная пластина для сифона ø 15 см



51 cromato 52 oro giallo 92 ottone antico spazzolato

AC 811



IT: Rubinetto per cassetta completo di raccordi
 DE: Eckventil für Spülkasten mit Anschlüssen
 FR: Robinet pour réservoir WC avec raccords
 EN: WC box tap with connections
 ES: Llave para cisterna completa
 RU: Кран для коробки в комплекте с соединениями

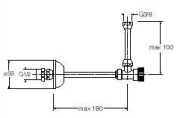

51 cromato 52 oro giallo 92 ottone antico spazzolato

AC 812



IT: Serie di viti fermavaso
 DE: WC-Befestigungsschrauben
 FR: Série de vis pour fixation toilettes
 EN: WC fixing screws
 ES: Kit de tornillos de fijación a la taza
 RU: Ряд винтов для крепления унитаза

51 cromato 52 oro giallo 92 ottone antico spazzolato

Technical Accessories

AC 950



IT: Piastra di montaggio per bordo vasca
 DE: Montageplatte für Wannranddematur
 FR: Plaque de montage pour bain douche sur gorge
 EN: Bath deck fixing plate
 ES: Placa de montaje para grupo bañera
 RU: Пластина для монтажа на бортике ванны

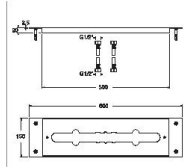

28 inox

AC 157



IT: Prolunga da 2 cm per rubinetto d'arresto incasso da 1/2"
 DE: Verlängerung 2 cm für UP-Absperrventil 1/2"
 FR: Rallonge 2 cm pour robinet d'arrêt encastré 1/2"
 EN: 2 cm extension for 1/2" concealed stopcock
 ES: Alargadera de 2 cms para llave de cierre empotrada 1/2"
 RU: Удлинитель 2 см для встраиваемого крана 1/2"

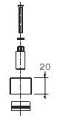

00 grigio

AC 457



IT: Prolunga da 4 cm per rubinetto d'arresto incasso da 1/2"
 DE: Verlängerung 4 cm für UP-Absperrventil 1/2"
 FR: Rallonge 4 cm pour robinet d'arrêt encastré 1/2"
 EN: 4 cm extension for 1/2" concealed stopcock
 ES: Alargadera 4 cms para llave de cierre empotrada 1/2"
 RU: Удлинитель 4 см для встраиваемого крана 1/2"

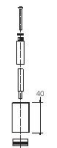

00 grigio

AC 458



IT: Prolunga da 2 cm per deviatore gruppo vasca incasso
 DE: Verlängerung 2 cm für Umsteller Unterputz Wannbatterie
 FR: Rallonge 2 cm pour inverseur bain douche encastré
 EN: 2 cm extension for concealed bath deck diverter
 ES: Alargadera 2 cms para desviador grupo bañera empotrada
 RU: Удлинитель 2 см для встраиваемого переключателя группы ванны

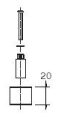

00 grigio

Technical Accessories

AC 601



IT Prolunga da 3 cm per UC
DE Verlängerung 3 cm für UC
FR Rallonge 3 cm pour UC
EN 3 cm extension for UC
ES Alargadera 3 cm para UC
RU Удлинитель 3 см для UC

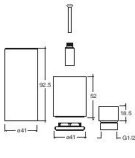

51 cromato

AC 637



IT Prolunga da 3 cm per CS 100 - CS 101 - CS 137 - CS 147 - TV/QM 608 - TV/QM 610 - TV/QM 611
DE Verlängerung 3 cm für CS 100 - CS 101 - CS 137 - CS 147 - TV/QM 608 - TV/QM 610 - TV/QM 611
FR Rallonge 3 cm pour CS 100 - CS 101 - CS 137 - CS 147 - TV/QM 608 - TV/QM 610 - TV/QM 611
EN 3 cm extension for CS 100 - CS 101 - CS 137 - CS 147 - TV/QM 608 - TV/QM 610 - TV/QM 611
ES Alargadera 3 cm para CS 100 - CS 101 - CS 137 - CS 147 - TV/QM 608 - TV/QM 610 - TV/QM 611
RU Удлинитель 3 см для CS 100 - CS 101 - CS 137 - CS 147 - TV/QM 608 - TV/QM 610 - TV/QM 611

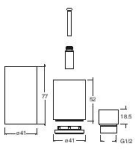

51 cromato 28 inox 13 negro opaco 34 oro rosa
46 oro rosa 52 oro 24 bianco opaco 34 oro rosa
72 cromo nero lucido 80 metalic lucido 77 metalic spazzolato

AC 869



IT Prolunga da 3 cm per UX 102 - UX 103 - UX 602 - UX 603
DE Verlängerung 3 cm für UX 102 - UX 103 - UX 602 - UX 603
FR Rallonge 3 cm pour UX 102 - UX 103 - UX 602 - UX 603
EN 3 cm extension for UX 102 - UX 103 - UX 602 - UX 603
ES Alargadera 3 cm para UX 102 - UX 103 - UX 602 - UX 603
RU Удлинитель 3 см для UX 102 - UX 103 - UX 602 - UX 603



28 inox

AC 619



IT Insieme deviatore per CS 535 (versione prolunga 3 cm)
DE Verlängerer Umsteller komplett für CS 535 (3 cm)
FR Ensemble inverseur CS 535 (version rallonge 3 cm)
EN Diverter kit for CS 535 (extension version 3 cm)
ES Desviador CS 535 (versión alargada 3 cm)
RU Переключатель CS 535 в сборе (версия удлинителя 3 см)



51 cromato 13 negro opaco 34 oro rosa 46 oro rosa
52 oro 72 cromo nero lucido 75 cromo nero spazzolato
80 metalic lucido 77 metalic spazzolato

Technical Accessories

AC 627



IT Insieme deviatore per DE 649 - EM 649 - GE 649 - ND 649 - PM 649 - OG 649 - 2P 649 (versione prolunga 3 cm)
DE Verlängerer Umsteller komplett für DE 649 - EM 649 - GE 649 - ND 649 - OG 649 - 2P 649 (3 cm)
FR Ensemble inverseur DE 649 - EM 649 - GE 649 - ND 649 - OG 649 - PM 649 - 2P 649 (versione rallonge 3 cm)
EN Diverter kit for DE 649 - EM 649 - GE 649 - ND 649 - OG 649 - PM 649 - 2P 649 (extension version 3 cm)
ES Desviador DE 649 - EM 649 - GE 649 - ND 649 - OG 649 - PM 649 - 2P 649 (versión alargada 3 cm)
RU Переключатель DE 649 - EM 649 - GE 649 - ND 649 - PM 649 - 2P 649 в сборе (версия удлинителя 3 см)



51 cromato

AC 402



IT Prolunga per gambo a 33x19"
DE Verlängerung für Schaft Ø 33 x 19"
FR Rallonge pour fixation Ø 33 x 19"
EN Shank extension Ø 33 x 19"
ES Alargadera para eje diam. 33x19"
RU Удлинитель для ножек ø 33 x 19"



00 grigio

AC 851



IT Prolunga da 2 cm per: XC 751, XC 752, XC 753, XE 751, XE 752, XE 753, XP 751, XP 752, XP 753, XT 751, XT 752, XT 753.
FR Rallonge 2 cm pour: XC 751, XC 752, XC 753, XE 751, XE 752, XE 753, XP 751, XP 752, XP 753, XT 751, XT 752, XT 753.
EN 2 cm extension for: XC 751, XC 752, XC 753, XE 751, XE 752, XE 753, XP 751, XP 752, XP 753, XT 751, XT 752, XT 753.
ES Alargadera 2 cm para: XC 751, XC 752, XC 753, XE 751, XE 752, XE 753, XP 751, XP 752, XP 753, XT 751, XT 752, XT 753.
RU Удлинитель 2 см для:



51 cromato 28 inox 13 negro opaco 34 oro rosa
46 oro rosa 52 oro 24 bianco opaco 34 oro rosa
72 cromo nero lucido 80 metalic lucido 75 cromo nero spazzolato
80 metalic lucido 77 metalic spazzolato

AC 727



IT Prolunga da 2 cm per: XV 751, XV 752, XV 753
DE Verlängerung 2 cm für: XV 751, XV 752, XV 753
FR Rallonge 2 cm pour: XV 751, XV 752, XV 753
EN 2 cm extension for: XV 751, XV 752, XV 753
ES Alargadera 2 cm para: XV 751, XV 752, XV 753
RU Удлинитель 2 см для:



51 cromato 13 negro opaco 34 oro rosa 46 oro rosa
52 oro 72 cromo nero lucido 75 cromo nero spazzolato
80 metalic lucido 77 metalic spazzolato



650 51 cromo-chrome / 00 grigio-raw / 02 bianco-white / 03 luce blu-light blue / 06 luce bianca-light white / 13 nero opaco-black mat / 24 bianco opaco-white mat / 28 inox-stainless steel / 34 oro rosa spazzolato-brushed rose gold / 46 oro rosa lucido-polished rose gold / 52 oro giallo-yellow gold / 53 ottone naturale-natural brass / 72 cromo nero lucido-polished black chrome / 75 cromo nero spazzolato-brushed black chrome / 77 metalic spazzolato-brushed metallic / 80 metalic lucido-polished metallic / 86 sfumato-shaded / 92 ottone antico spazzolato-brushed old brass

51 cromo-chrome / 00 grigio-raw / 02 bianco-white / 03 luce blu-light blue / 06 luce bianca-light white / 13 nero opaco-black mat / 24 bianco opaco-white mat / 28 inox-stainless steel / 34 oro rosa spazzolato-brushed rose gold / 46 oro rosa lucido-polished rose gold / 52 oro giallo-yellow gold / 53 ottone naturale-natural brass / 72 cromo nero lucido-polished black chrome / 75 cromo nero spazzolato-brushed black chrome / 77 metalic spazzolato-brushed metallic / 80 metalic lucido-polished metallic / 86 sfumato-shaded / 92 ottone antico spazzolato-brushed old brass

Technical Accessories

AC 852 new

IT Prolunga da 2 cm per XF 751 - XF 752 - XF 753
 DE Verlängerung 2 cm für XF 751 - XF 752 - XF 753
 FR Rallonge 2 cm pour XF 751 - XF 752 - XF 753
 EN 2 cm extension for XF 751 - XF 752 - XF 753
 ES Alargadera 2 cms para XF 751 - XF 752 - XF 753
 RU Удлинитель 2 см для XF 751 - XF 752 - XF 753





51 cromoato 13 negro opaco* 34 oro rosa
 24 bianco opaco* 46 oro rosa
 72 cromo nero lucido 75 cromo nero spazzolato
 80 metallic lucido 77 metallic spazzolato

AC 862

IT Prolunga da 2 cm per comando termostatico:
 DE Einzelverlängerung 2 cm für Thermostatische Antrieb:
 FR Rallonge 2 cm pour poignée thermostatique:
 EN 2 cm extension for thermostat control:
 ES Alargadera de 2 cms para termostato:
 RU Удлинитель 2 см для термостатического управления:

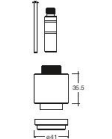
XC 700, XC 711, XC 782, XC 783, XC 784, XP 700, XP 711, XP 782, XP 783, XP 784, XT 700, XT 766, XT 767, XT 768, XT 769, XT 771, XT 782, XT 783, XT 784

51 cromoato 28 inox 34 oro rosa spazzolato 46 oro rosa lucido
 52 oro giallo 72 cromo nero lucido 75 cromo nero spazzolato
 80 metallic lucido 77 metallic spazzolato

AC 863

IT Prolunga singola da 3 cm per valvola d'arresto:
 DE Einzelverlängerung 3 cm für Eckventile:
 FR Rallonge unique 3 cm pour robinet d'arrêt:
 EN 3 cm single extension for shut-off valve:
 ES Alargadera 3 cms para válvula de cierre:
 RU Одиночный удлинитель 3 см для запорного клапана:

XC 720, XC 710, XC 771, XC 782, XC 783, XC 784, XP 720, XP 710, XP 771, XP 782, XP 783, XP 784, XT 720, XT 710, XT 766, XT 767, XT 768, XT 769, XT 771, XT 782, XT 783, XT 784



51 cromoato 28 inox 13 negro opaco 24 bianco opaco 34 oro rosa spazzolato
 46 oro rosa lucido 52 oro giallo 72 cromo nero lucido 75 cromo nero spazzolato
 80 metallic lucido 77 metallic spazzolato

AC 854 new

IT Prolunga da 2 cm per XQ 751 - XQ 752 - XQ 753
 DE Verlängerung 2 cm für XQ 751 - XQ 752 - XQ 753
 FR Rallonge 2 cm pour XQ 751 - XQ 752 - XQ 753
 EN 2 cm extension for XQ 751 - XQ 752 - XQ 753
 ES Alargadera 2 cms para XQ 751 - XQ 752 - XQ 753
 RU Удлинитель 2 см для XQ 751 - XQ 752 - XQ 753

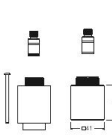
51 cromoato 13 negro opaco 34 oro rosa spazzolato 46 oro rosa lucido
 52 oro giallo 72 cromo nero lucido 75 cromo nero spazzolato
 80 metallic lucido 77 metallic spazzolato

Technical Accessories

AC 865

IT Prolunga da 2 cm per comando termostatico:
 DE Verlängerung 2 cm für Thermostatische Antrieb:
 FR Rallonge 2 cm pour poignée thermostatique:
 EN 2 cm extension for thermostat control:
 ES Alargadera 2 cms para termostato:
 RU Удлинитель 2 см для термостатического управления:

XQ 700, XQ 766, XQ 767, XQ 768, XQ 769, XQ 771, XQ 782, XQ 783, XQ 784



51 cromoato 13 negro opaco 34 oro rosa spazzolato 46 oro rosa lucido
 52 oro giallo 72 cromo nero lucido 75 cromo nero spazzolato
 80 metallic lucido 77 metallic spazzolato

AC 866

IT Prolunga singola da 3 cm per valvola d'arresto:
 DE Einzelverlängerung 3 cm für Eckventile:
 FR Rallonge unique 3 cm pour robinet d'arrêt:
 EN 3 cm single extension for shut-off valve:
 ES Alargadera 3 cms para válvula de cierre:
 RU Удлинитель 2 см для термостатического управления:

XQ 720, XQ 766, XQ 767, XQ 768, XQ 769, XQ 810, XQ 871, XQ 882, XQ 883, XQ 884



51 cromoato 13 negro opaco 34 oro rosa spazzolato 46 oro rosa lucido
 52 oro giallo 72 cromo nero lucido 75 cromo nero spazzolato
 80 metallic lucido 77 metallic spazzolato

AC 901

IT Coppia prolunga da 6 cm per vasca a muro fil. 3/4" Mx3/4" F
 DE Verlängerungsstücke 6 cm für Wannenbatterie Wandmontage Gewinde 3/4" M x 3/4" F
 FR Paire de rallonge 6 cm pour bain dalle mural 3/4" M x 3/4" F
 EN 6 cm threaded extension for 3/4" M x 3/4" F wall mounted bath mixer
 ES Juego de alargadores de 6 cms para bañera a muro 3/4" Mx3/4" F
 RU Пара настенных удлинительей 6 см для ванны, резьба 3/4" M x 3/4" F

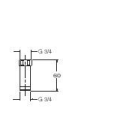
51 cromoato

AC 602

IT Chiave universale per aeratore caché
 DE Universal Schlüssel für Pelletor caché
 FR Clef universel pour aérateurs caché
 EN Universal key for caché aerators
 ES Llave universal para aërador
 RU Универсальный ключ для аэратора

00 grigio

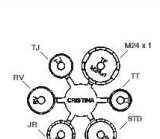
51 cromoato-chrome / 00 grigio-raw / 02 bianco-white / 03 luce blu-light blue / 06 luce bianca-light white / 13 negro opaco-black mat / 24 bianco opaco-white mat / 28 inox-stainless steel
 34 oro rosa spazzolato-brushed rose gold / 46 oro rosa lucido-polished rose gold / 52 oro giallo-yellow gold / 53 ottone naturale-natural brass / 72 cromo nero lucido-polished black chrome
 75 cromo nero spazzolato-brushed black chrome / 77 metallic spazzolato-brushed metallic / 80 metallic lucido-polished metallic / 86 sfumato-shaded / 92 ottone antico spazzolato-brushed old brass

51 cromoato-chrome / 00 grigio-raw / 02 bianco-white / 03 luce blu-light blue / 06 luce bianca-light white / 13 negro opaco-black mat / 24 bianco opaco-white mat / 28 inox-stainless steel
 34 oro rosa spazzolato-brushed rose gold / 46 oro rosa lucido-polished rose gold / 52 oro giallo-yellow gold / 53 ottone naturale-natural brass / 72 cromo nero lucido-polished black chrome
 75 cromo nero spazzolato-brushed black chrome / 77 metallic spazzolato-brushed metallic / 80 metallic lucido-polished metallic / 86 sfumato-shaded / 92 ottone antico spazzolato-brushed old brass

Technical Accessories

AC 530



IT Chiave a tubo per dado ch. 13/16
 DE Steckschlüssel für Mutter ch. 13/16
 FR Clé à tube pour écrou ch. 13/16
 EN Box spanner for ch. 13/16 nut
 ES Llave a tubo para tornillo 13/16
 RU Ключ для гаек ch. 13/16



S1 cromato

AC 610



IT Chiave a tubo per dado ch. 9/10
 DE Steckschlüssel für Mutter ch. 9/10
 FR Clé à tube pour écrou ch. 9/10
 EN Box spanner for ch. 9/10 nut
 ES Llave a tubo para tornillo 9/10
 RU Ключ для гаек ch. 9/10



S1 cromato

AC 256



IT Chiave per cartuccia ch. 27/21
 DE Montageschlüssel ch 27 für Kartusche
 FR Clé pour cartouche ch.27
 EN Wrench for ch. 27 cartridge
 ES Llave para cartucho 27/21
 RU Ключ для картриджа ch. 27/21



00 grigio

AC 925



IT Prolunga per WJ 673 - WJ 674 - WJ 676 - WJ 677
 DE Verlängerung für WJ 673 - WJ 674 - WJ 676 - WJ 677
 FR Rallonge pour WJ 673 - WJ 674 - WJ 676 - WJ 677
 EN Extension for WJ 673 - WJ 674 - WJ 676 - WJ 677
 ES Alargadera para WJ 673 - WJ 674 - WJ 676 - WJ 677
 RU Удлинитель для WJ 673 - WJ 674 - WJ 676 - WJ 677

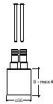

S1 cromato 13 nero opaco 34 oro rosa 46 oro rosa
 24 bianco opaco spazzolato lucido
 S2 oro 72 cromo nero lucido 75 cromo nero spazzolato
 giallo 80 metallic lucido 77 metallic spazzolato