

Caracalla



Caracalla



GRES PORCELLANATO
SMALTATO

DIGITAL
TECHNOLOGY

La bellezza eterna e il moderno design

Pietre naturali, ognuna diversa
naturali, lappate, rettificate,
impresiosite di mosaici
per ambientazioni esclusive.
Stile italiano inimitabile di Vallelunga.

The timeless beauty and modern design

Natural stones, each one different
natural, semipolished, rectified
made precious with mosaics
for exclusive environments
Vallelunga Italian inimitable style

Божественная красота и современный дизайн

Природный камень, каждый уникален по-своему
натуральный, лапатированный, ректифицированный,
украшен мозаикой
для эксклюзивного интерьера.
Единственный и неповторимый стиль Валлелунги.

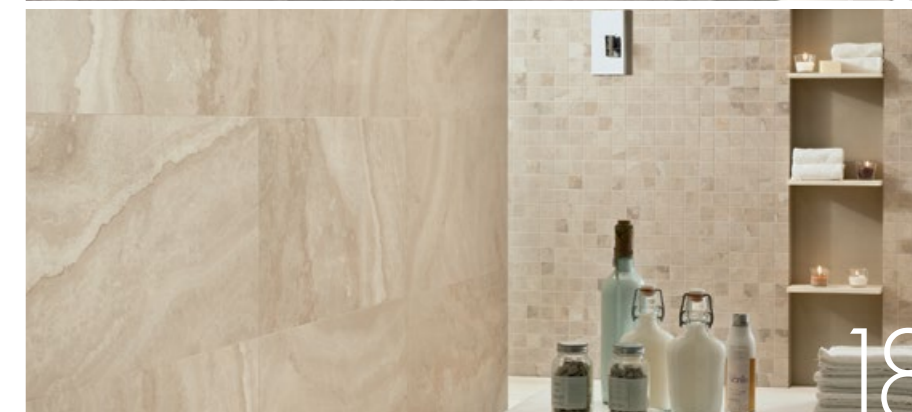

AVORIO

45x90
BACCHETTA CROMO 1,5x90



AVORIO

45x90



AVORIO

45x90
BACCHETTA CROMO 1,5x90





AVORIO

45x45





AVORIO

45x45
BATTISCOPIA 8x45



GRIGIO

45x90
BACCHETTA CROMO 1,5x90



GRIGIO

45x90
BACCHETTA CROMO 1,5x90





GRIGIO

45x45



GRIGIO

45x45



SABBIA

45x90
45x45
MOSAICO 30x30



SABBIA

MOSAICO 30x30



SABBIA

45x90
45x45
MOSAICO 30x30





SABBIA

45x45



SABBIA

45x45



AVORIO

GRIGIO

SABBIA



G103SM AVORIO MURETTO 15
30x30 - 12"x12"

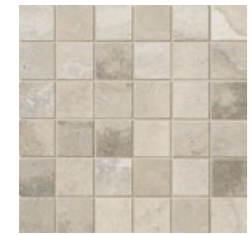

G100SM AVORIO MOSAICO 15
TESSERE 5x5
30x30 - 12"x12"



G2000A CARACALLA AVORIO LAPP. RETT. 68
11x45 - 4,4"x17,7"



G103FL CARACALLA AVORIO LAPP. RETT. 65
45x45 - 17,7"x17,7"

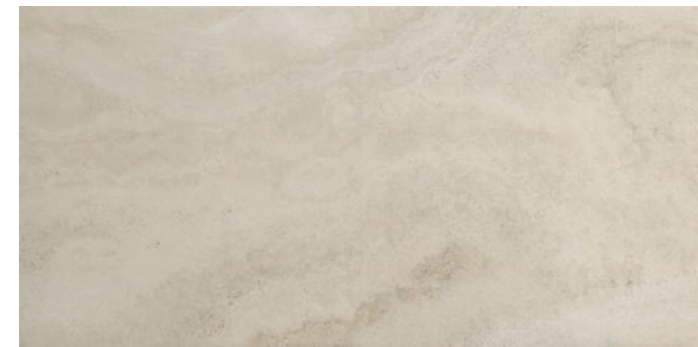

G100FL CARACALLA AVORIO LAPP. RETT. 67
45x90 - 17,7"x35,5"

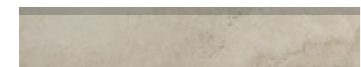

G10002 AVORIO BATTISCOPIA LAPP. RETT. 12
8x45 - 3,1"x17,7"



G104SM GRIGIO MURETTO 15
30x30 - 12"x12"



G101SM GRIGIO MOSAICO 15
TESSERE 5x5
30x30 - 12"x12"



G2014A CARACALLA GRIGIO LAPP. RETT. 68
11x45 - 4,4"x17,7"

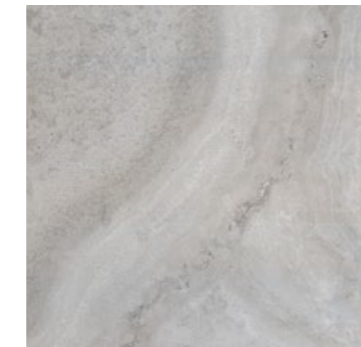

G104FL CARACALLA GRIGIO LAPP. RETT. 65
45x45 - 17,7"x17,7"



G101FL CARACALLA GRIGIO LAPP. RETT. 67
45x90 - 17,7"x35,5"



G10003 GRIGIO BATTISCOPIA LAPP. RETT. 12
8x45 - 3,1"x17,7"



G105SM SABBIA MURETTO 15
30x30 - 12"x12"

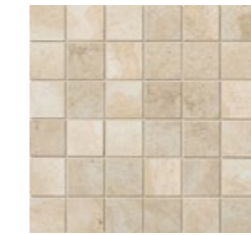

G102SM SABBIA MOSAICO 15
TESSERE 5x5
30x30 - 12"x12"

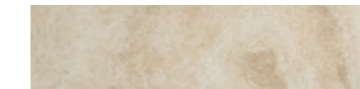

G2015A CARACALLA SABBIA LAPP. RETT. 68
11x45 - 4,4"x17,7"



G105FL CARACALLA SABBIA LAPP. RETT. 65
45x45 - 17,7"x17,7"



G102FL CARACALLA SABBIA LAPP. RETT. 67
45x90 - 17,7"x35,5"

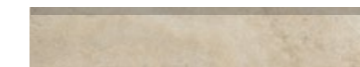

G10001 SABBIA BATTISCOPIA LAPP. RETT. 12
8x45 - 3,1"x17,7"

G30803 ANG. 6
BACCHETTA ALLUMINIO
1,5x1,5 - 0,6"x0,6"

G30801 BACCHETTA ALLUMINIO 19
1,5x90 - 0,6"x35,5"

G30804 ANG. 6
BACCHETTA CROMO
1,5x1,5 - 0,6"x0,6"

G30802 BACCHETTA CROMO 19
1,5x90 - 0,6"x35,5"

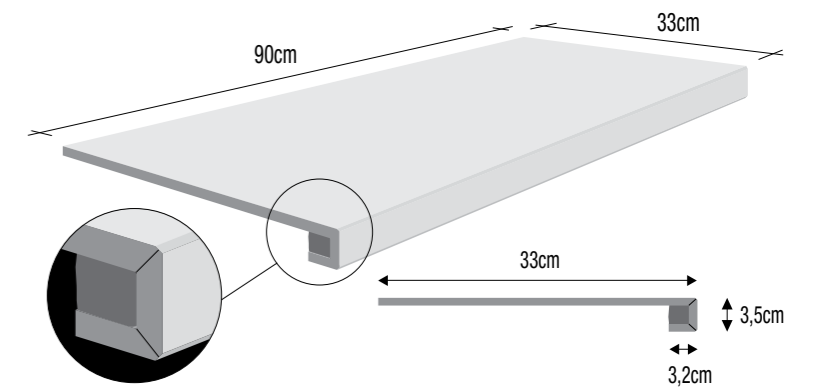

GRADONE 33x90 13"x35,5"

Gradone disponibile per ogni colore della serie su richiesta.
Gradone available upon request for each color of the collection.

Caracalla

Imballaggi - packing - emballages - verpackung - Упаковки

Formato Size cm Format cm Format cm Формат см	Pezzi/scatola Pieces/box Pièces/boîte Stück/Karton Изделий/коробку	Mq/scatola Sq.Mt./box Mq/boîte Qm/Karton M2/коробку	Kg/scatola Sq.Mt./box Poids/boîte Gewichte/Karton Кг/коробку	Scatole/pallet Box/pallet Boîte/pallet Karton/pallet Коробок/паллеты	Mq/pallet Sq.Mt./pallet Mq/pallet Qm/pallet M2/паллеты	Kg/pallet Weight/pallet Poids/pallet Gewichte/pallet Кг/паллеты	Scatole/europallet Box/europallet Boîte/europallet Karton/europallet Коробки/Европалетки	Mq/europallet Sq.Mt./europallet Mq/europallet Qm/europallet M2/Европалетки	Kg/europallet Weight/europallet Poids/europallet Gewichte/europallet Кг/ Европалетки	Spessore Thickness Epaisseur Stärke Толщина
45x90 Fondo	3	1,22	28,40	32	39,04	930,50	-	-	-	10
45x45 Fondo	7	1,42	31,80	26	36,92	848,50	-	-	-	10
11x45 Fondo	14	0,69	15,76	44	30,36	715,14	-	-	-	10
30x30 Muretto	6	-	-	-	-	-	-	-	-	-
30x30 Mosaico	9	-	17,47	-	-	-	-	-	-	-
8x45 Battiscopa	20	-	14,5	-	-	-	-	-	-	-

CARATTERISTICHE TECNICHE Technical Characteristics / Caractéristiques Techniques / Technische Eigenschaften CONFORME / ACCORDING TO / CONFORME / GEMÄß: ANSI 137.1 Impervious porcelain tiles				
TEST METHOD METHODE D'ESSAI PRÜFMETHODE	REQUISITI PRESCRITTI Required Value Valeur Requisie Vorgeschriebener Wert ANSI 137.1	VALORI Value/Valueur/Wert VALLELUNGA SMALZATO GLAZED GLZ		
ASSORBIMENTO D'ACQUA WATER ABSORPTION ABSORPTION D'EAU WASSERABSORPTION	EN-ISO 10545-3	0,5% (fully vitrified)	≤ 0,05	
RESISTENZA ALLA ROTTURA BREAKING MODULUS RÉSISTANCA À LA FLEXION BIEGEFESTIGKEIT	EN-ISO 10545-4	≥250 Pounds ≥113 Kg ≥1110 N	CONFORME Compliant	
DUREZZA MOHS MOHS HARDNESS DURETÉ MOHS HAERTE MOHS	EN-ISO 101		MOHS 5	
RESISTENZA ALL'ABRASIONE ABRASION RESISTANCE RÉSISTANCE À L'ABRASION ABRASIONSWIDERSTÄNDIGKEIT	EN-ISO 10545-7	NON RICHIESTO Not required	METODO DI PROVA ISO 10545-7 PEI IV	
RESISTENZA AGLI SBALZI TERMICI THERMAL SHOCK RESISTANCE RÉSISTANCE AUX CHOC THERMIQUES TEMPERATURWECHSELBESTÄNDIGKEIT	ASTM C484	RICHIESTO required	RESISTENTE Resistant	
RESISTENZA ALL'ATTACCO CHIMICO CHEMICAL RESISTANCE RÉSISTANCE CHIMIQUE CHEMISCHE BESTÄNDIGKEIT	EN-ISO 10545-13	NON RICHIESTO Not required	RESISTENTE Resistant	
RESISTENZA AL GELO FROST RESISTANCE RÉSISTANCE AU GEL FROSTBESTÄNDIGKEIT	EN-ISO 10545-12	NON RICHIESTO Not required	RESISTENTE Resistant	
RESISTENZA ALLE MACCHIE STAIN RESISTANCE RÉSISTANCE AUX TACHES FLECKENBESTÄNDIGKEIT	EN-ISO 10545-14	NON RICHIESTO Not required	RESISTENTE Resistant	
SPESORE THICKNESS ÉPAISSEUR STÄRKE	ASTM C485 Planarità Warpage	≤ 1,0% Sui lati/On sides ≤ 0,75% Sulle diagonali/On diagonals	CONFORME Compliant	
	ASTM C499 Dimensioni Dimensions	≤ 3,0% Sulle dimensioni nominali Of nominal dimensions ≤ 1,5% Differenza nel lotto tra valori min. e max./Difference in batch between min. and major values	CONFORME Compliant	
	ASTM C499 Spessore Thickness	≤ 0,040 inch Differenza nel lotto tra spessore min. e max. Difference in batch between min. and major thickness	CONFORME Compliant	
	ASTM C502 Parallelismo dei lati Wedging	≤ 1,0 %	CONFORME Compliant	

**AMOUNT OF
COLOUR
VARIATION**

**V3
HIGH
COLOR
VARIATION**

Ceramica Vallelunga Inc. is committed to the environment's respect and designs its products so that they can be eco-friendly and meet the needs of environmental sustainability. Particularly, CARACALLA tiles are characterized by a number of pre-consumer recycled content of 17.5%





01036 NEPI (VT) Loc. Settevene Via dell'Industria n, 7 Tel. 0761 5291 - 4 linee - Fax. 0761 527156
www.vallelungacer.it - www.vallelungaceramica.ru