



WOODTIME
GRES FINE PORCELLANATO

★★★★★
MONOCIBEC®
FINCIBEC GROUP

WOODTIME

GRES FINE PORCELLANATO
FINE PORCELAIN STONEWARE

Grazie a un profondo realismo di superficie, Woodtime interpreta tutta la bellezza delle venature irregolari tipiche del legno con maestria ed eleganza. Proposto in cinque tonalità calde e avvolgenti la collezione dona carattere ad ambienti dai tratti contemporanei e dal sapore sofisticato. L'ampia gamma, che include 5 formati per progettare in libertà, è completata dal 40x120 in 2 cm di spessore, una soluzione resistente perfetta per esterni residenziali e commerciali di pregio.

With the profound realism of its surfaces, Woodtime interprets all the beauty of typical irregular wood grains with mastery and elegance. Available in five warm and embracing shades, the collection gives character to contemporary and sophisticated rooms.

The wide range, which includes 5 sizes for design freedom, includes the 40x120, 2 cm thick option, a resistant solution that is ideal for residential and commercial exteriors.

★★★★★
MONOCIBEC®
FINCIBEC GROUP

WOODTIME

GRES FINE PORCELLANATO
FINE PORCELAIN STONEWARE

10 MM

FORMATI/SIZES



40X160



26,6X160



20X160



30X120



20X120

SUPERFICI/SURFACES
naturale/natural
GRIP

BORDO/EDGE
RETTIFICATO/RECTIFIED

20 MM MAJOR

FORMATI/SIZES

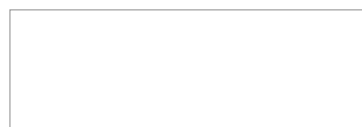

40X120

SUPERFICI/SURFACES
ANTISLIP

BORDO/EDGE
RETTIFICATO/RECTIFIED





WOODTIME

ARBETE BIANCO

04

05



*Ambiente realizzato con:
Setting realized with:*

ABETE BIANCO

26,6X160 NAT.

20X160 NAT.

maxi 19X120

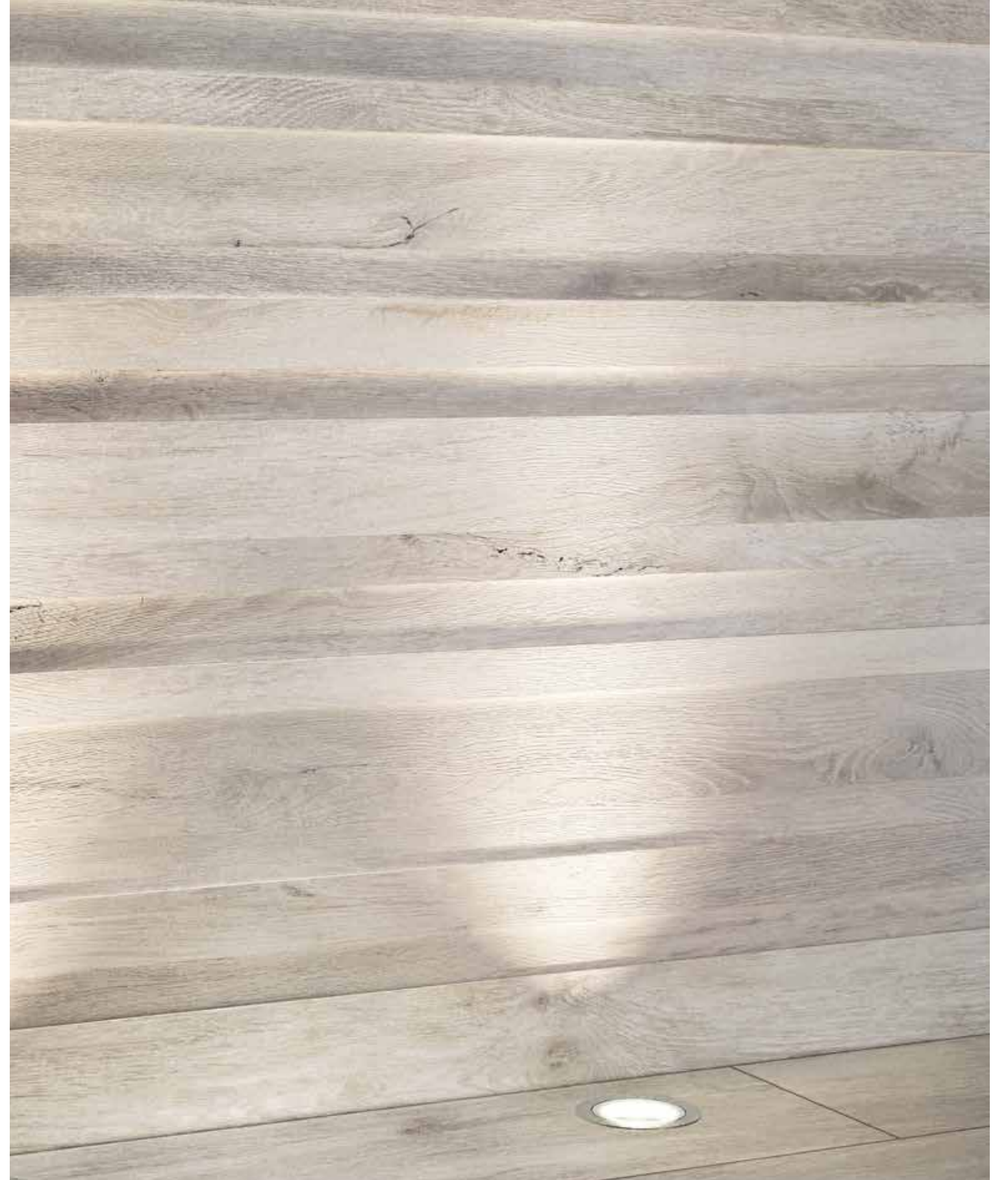



WOODTIME

LARICE



Ambiente realizzato con:
Setting realized with:

LARICE
26,6X160 nat.
20X160 nat.
20X120 GRIP

LARICE





IROKO

WOODTIME



Ambiente realizzato con:
Setting realized with:

IROKO

26,6X160 nat.

20X160 nat.

Line 15X120

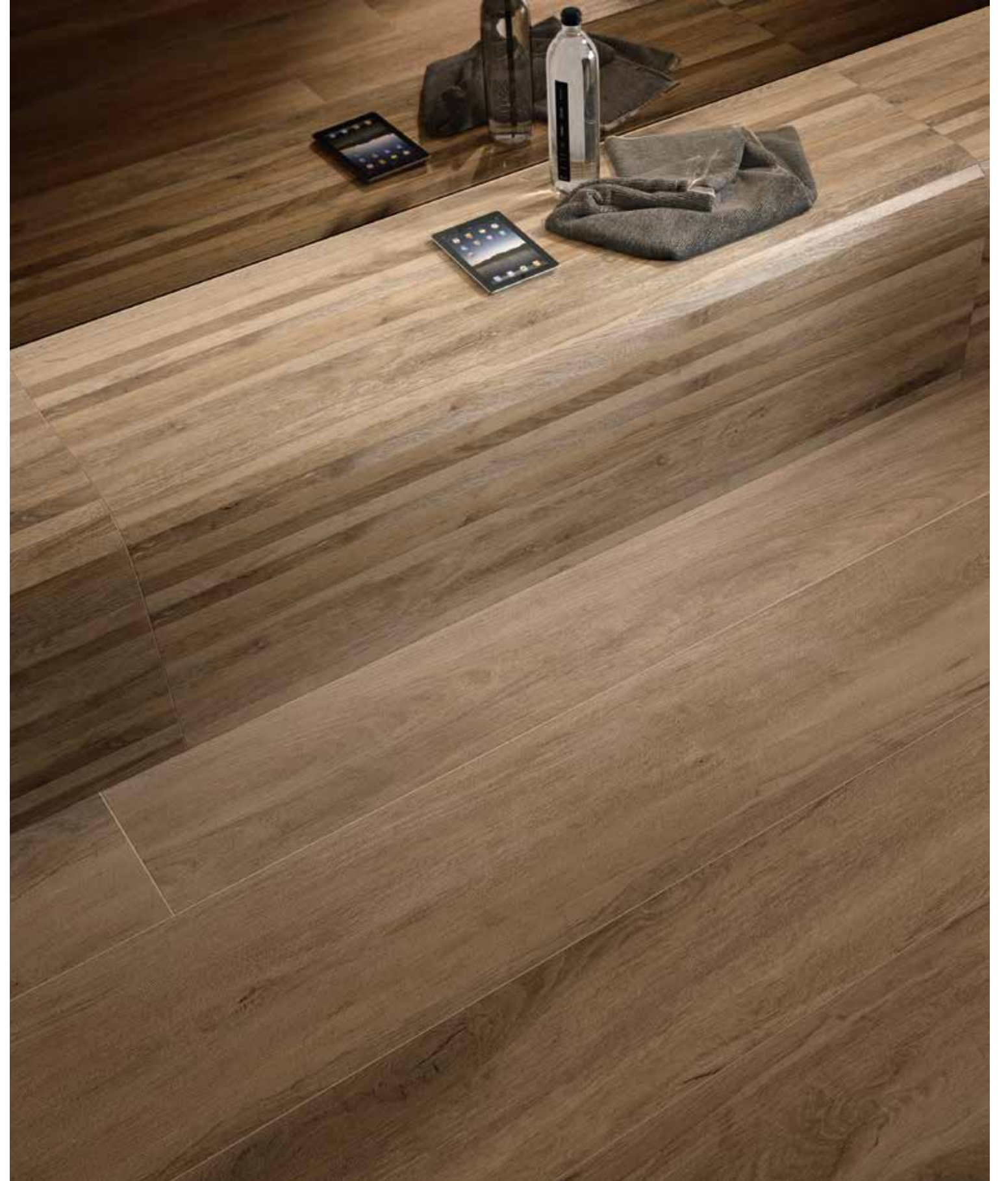
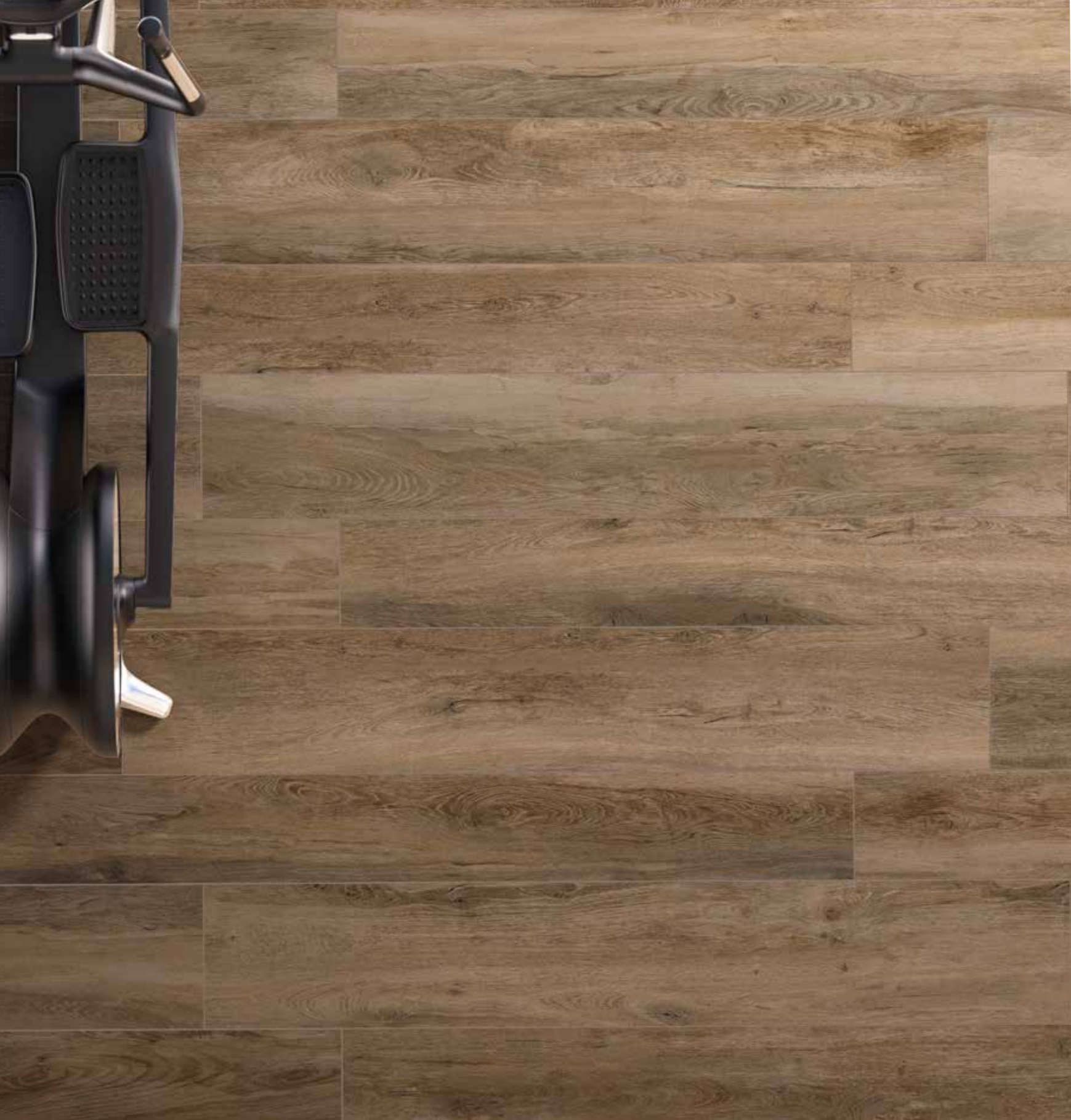



CARPINO

WOODTIME



*Ambiente realizzato con:
Setting realized with:*

CARPINO

20X120 nat.

20X120 GRIP

Bordo Line e

Angolo bordo Line interno dx e sx

20X60

Griglia Hole e

Angolo griglia Hole **20X60**

(10+10 mm)

Mosaico **2,5X2,5**

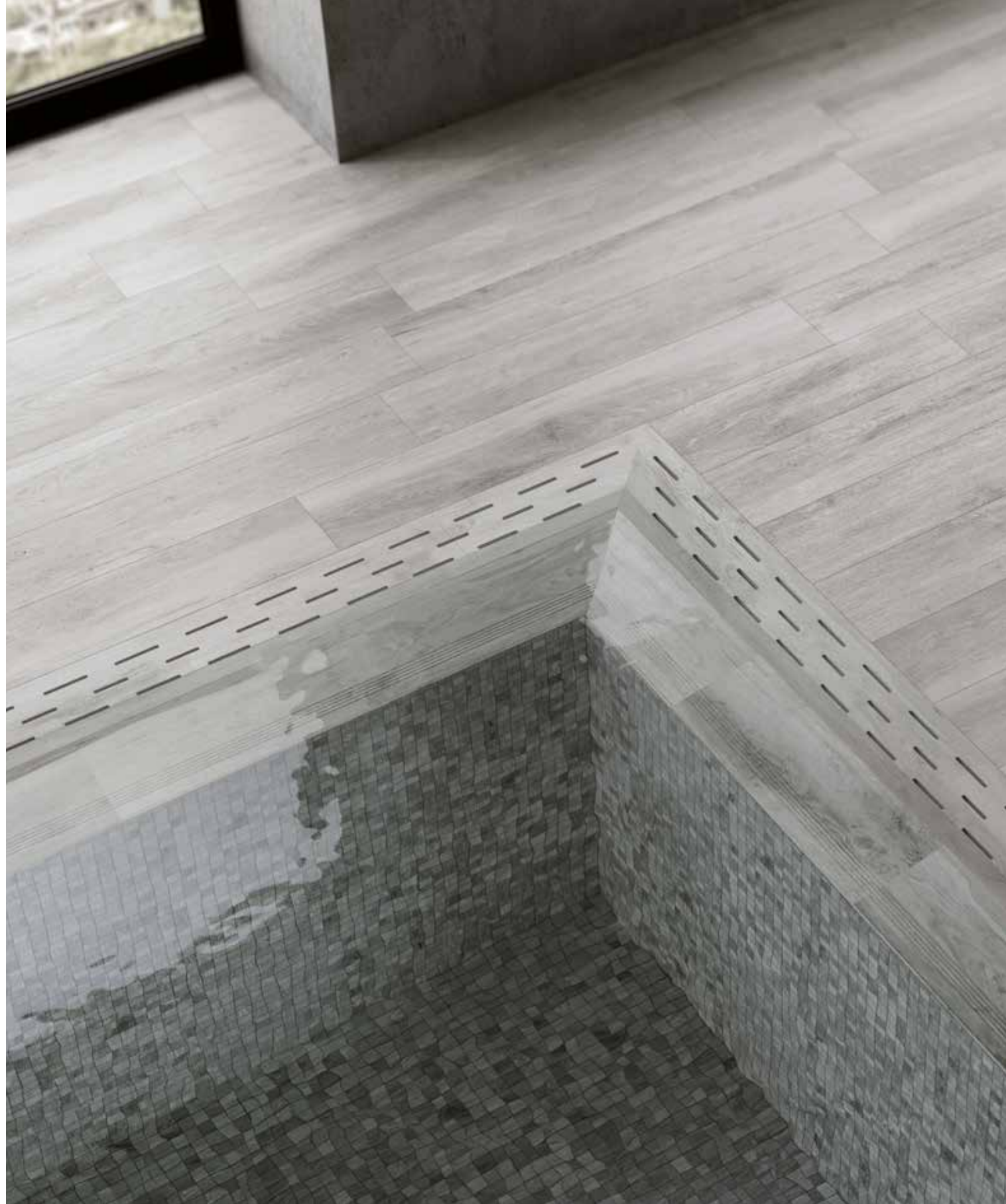

CARPINO **20X120**

Bordo Line, Angolo bordo Line interno dx e sx **20X60**

Griglia Hole e Angolo griglia Hole **20X60 (10+10 mm)**

Mosaico **2,5X2,5**





Ambiente realizzato con:
Setting realized with:

CARPINO

26,6X160 . 20X160

CARPINO





CASTAGNO



Ambiente realizzato con:
Setting realized with:

CASTAGNO

26,6X160 nat.

20X160 nat.

20X120 GRIP

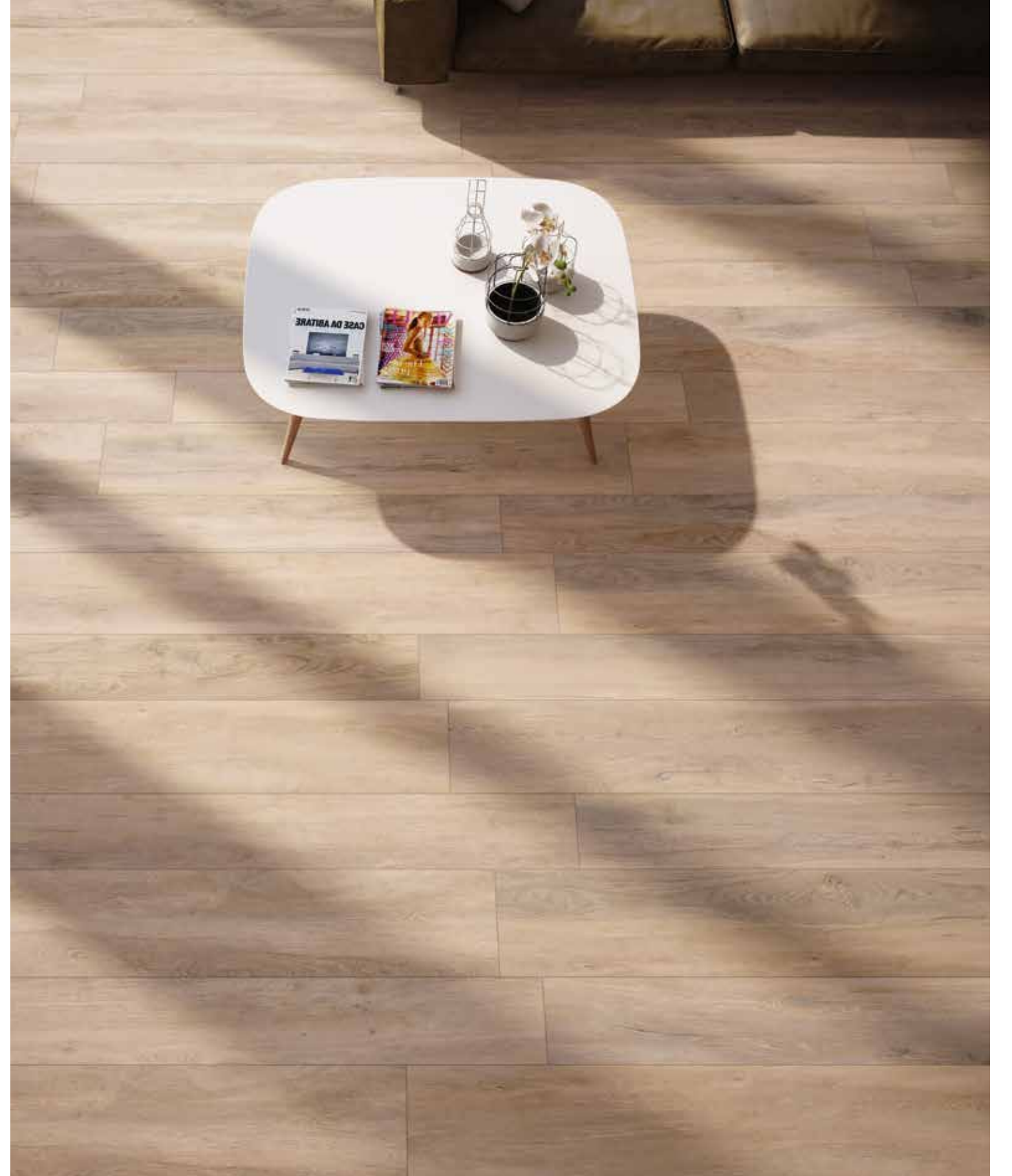



Ambiente
realizzato con:
Setting realized with:
CASTAGNO
40X120 major
(antislip)
20X120 nat.

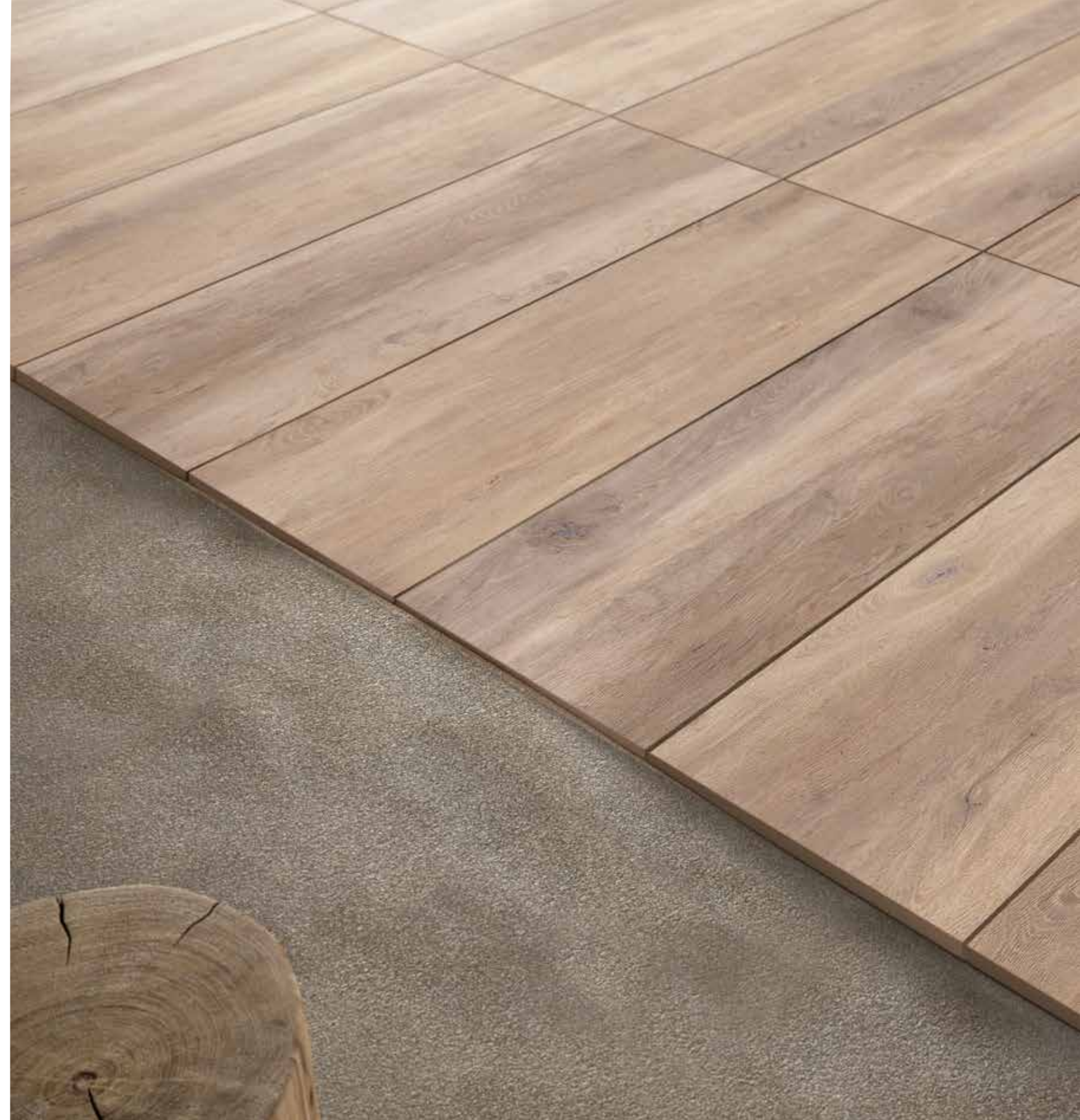



ABETE BIANCO



LARICE



IROKO



CARPINO



CASTAGNO

WOODTIME

GRES FINE PORCELLANATO
FINE PORCELAIN STONEWARE

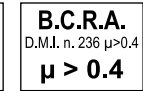
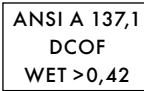
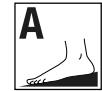

NAT

GRIP MAJOR

NAT

GRIP MOSAICO MAJOR

MAJOR

MAJOR

C5

V3

10 MM

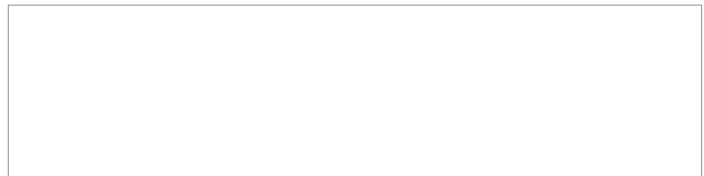

40X160 - 16''X63'' NAT. RETT.

- 89166 Abete Bianco
- 89169 Larice
- 89168 Iroko
- 89274 Carpino
- 89167 Castagno

■ 165



26,6X160 - 10,5''X63'' NAT. RETT.

- 88243 Abete Bianco
- 88236 Larice
- 88255 Iroko
- 89273 Carpino
- 88249 Castagno

■ 165



20X160 - 8''X63'' NAT. RETT.

- 88242 Abete Bianco
- 88235 Larice
- 88254 Iroko
- 89271 Carpino
- 88248 Castagno

■ 165

PEZZI SPECIALI SPECIAL PIECES

BATTISCOPA



7,2X60 - 2,8''X24'' NAT. RETT.

● 17

GRADONE COSTA RETTA

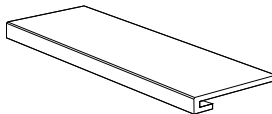

120X33 - 47''X13'' NAT.

● 240

TORELLO SU RETE

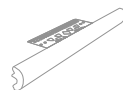

4X60 - 1,5''X24'' NAT.

● 105

ANGOLARE COSTA RETTA DX / SX

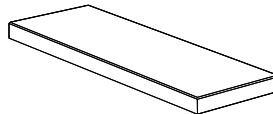

120X33 - 47''X13'' NAT.

● 249

ELEMENTO ELLE



15X30X4 - 6''X12''X1,5'' GRIP

● 38

ANGOLARE COSTA RETTA

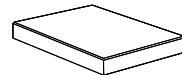

33X33 - 13''X13'' NAT.

● 197

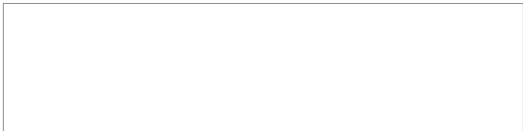

30X120 - 12''X47'' NAT. RETT.

- 89257 Abete Bianco
- 89263 Larice
- 89261 Iroko
- 89272 Carpino
- 89259 Castagno

■ 135



20X120 - 8''X47'' NAT. RETT.

- 88241 Abete Bianco
- 88231 Larice
- 88252 Iroko
- 89270 Carpino
- 88246 Castagno

■ 135



20X120 - 8''X47'' GRIP RETT.

- 88239 Abete Bianco
- 88233 Larice
- 88250 Iroko
- 89268 Carpino
- 88244 Castagno

■ 135

WOODTIME

GRES FINE PORCELLANATO
FINE PORCELAIN STONEWARE

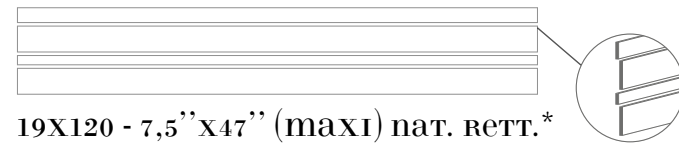
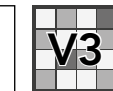
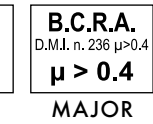

19X120 - 7,5''x47'' (maxi) nat. rett.*

- 89618 Abete Bianco
- 89621 Larice
- 89620 Iroko
- 89617 Carpino
- 89619 Castagno

● 147



15X120 - 6''x47'' (Line) nat. rett.

- 89556 Abete Bianco
- 89560 Larice
- 89559 Iroko
- 89557 Carpino
- 89558 Castagno

■ 230

* Due versioni - Two versions

40X120 MAJOR / ALTO SPESSORE 20 MM

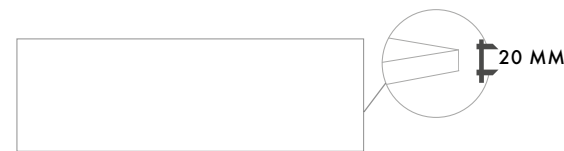

40X120 - 16''x47'' ANTISLIP RETT.

- 89937 Carpino
- 89938 Castagno

■ 179

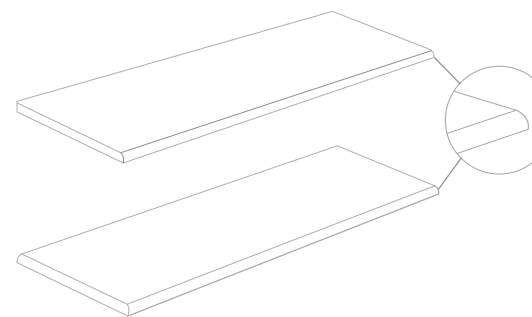

40X120 - 16''x47'' GRADONE ANTISLIP RETT.

● 232

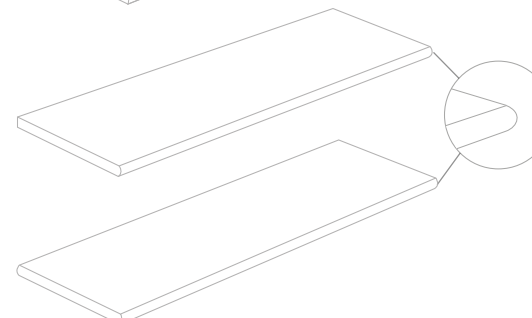

40X120 - 16''x47'' GRADONE CON TORO ANTISLIP RETT.

● 235

40X120 - 16''x47'' ANGOLARE CON TORO DX/SX ANTISLIP RETT.

● 254

MOSAICO

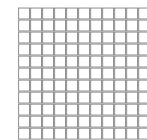

2,5X2,5 - 1''x1'' su foglio
30X30 - 12''x12''

- 89528 Abete Bianco
- 89527 Larice
- 89531 Iroko
- 89530 Carpino
- 89529 Castagno

■ 222

WOODTIME

POOLS & WELLNESS

PEZZI SPECIALI / SPECIAL PIECES

10 MM



Bordo Line
grip 20x60 - 8"x24"

● 83

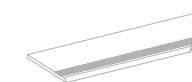

Angolo Bordo Line interno DX
grip 20x60 - 8"x24"

● 109



Angolo Bordo Line interno SX
grip 20x60 - 8"x24"

● 109

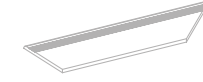

Angolo Bordo Line esterno SX
grip 20x60 - 8"x24"

● 109



Angolo Bordo Line esterno DX
grip 20x60 - 8"x24"

● 109



Angolo Curvo Line esterno
grip 20x20 - 8"x8"

● 160

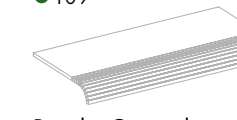

Bordo Curved
grip 30x60 - 12"x24"

● 157

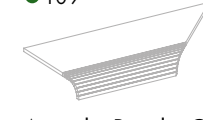

Angolo Bordo Curved interno DX
grip 30x60 - 12"x24"

● 181

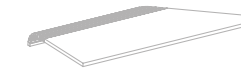

Angolo Bordo Curved interno SX
grip 30x60 - 12"x24"

● 181

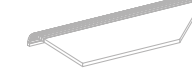

Angolo Bordo Curved esterno DX
grip 30x60 - 12"x24"

● 181

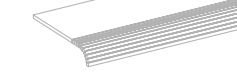

Angolo Bordo Curved esterno DX
grip 30x60 - 12"x24"

● 181

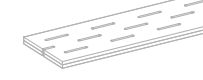

Griglia Hole (10+10 mm)
grip 20x60 - 8"x24"

● 215

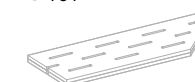

Angolo Griglia Hole Double face
(10+10 mm) grip 20x60 - 8"x24"

● 204

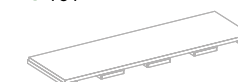

Griglia Slot
(10+10 mm) grip 20x60 - 8"x24"

● 165



Angolo Griglia Slot DX
(10+10 mm) grip 20x60 - 8"x24"

● 194



Angolo Griglia Slot SX
(10+10 mm) grip 20x60 - 8"x24"

● 194

20 MM

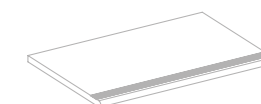

Bordo Line rettilineo con toro
antislip 40x60 - 16"x24"

● 199

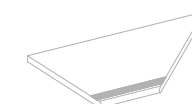

Angolo Line interno con toro DX
antislip 40x60 - 16"x24"

● 227

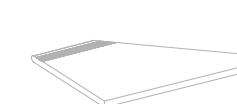

Angolo Line interno con toro SX
antislip 40x60 - 16"x24"

● 227

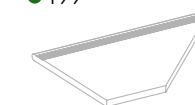

Angolo Line esterno con toro SX
antislip 40x60 - 16"x24"

● 227

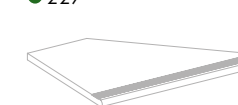

Angolo Line esterno con toro DX
antislip 40x60 - 16"x24"

● 227



Angolo Curvo Line esterno con toro
antislip 40x40 - 16"x16"

● 247

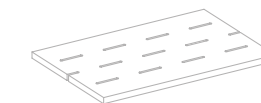

Griglia 40 cm
antislip 40x60 - 16"x24"

● 222

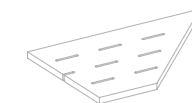

Angolo Griglia DX 40 cm
antislip 40x60 - 16"x24"

● 225



Angolo Griglia SX 40 cm
antislip 40x60 - 16"x24"

● 225



Griglia 20 cm
antislip 20x60 - 8"x24"

● 199



Angolo Griglia DX 20 cm
antislip 20x60 - 8"x24"

● 208



Angolo Griglia SX 20 cm
antislip 20x60 - 8"x24"

● 208

WOODTIME

SCHEMI DI POSA MODULAR LAYOUT

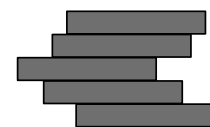
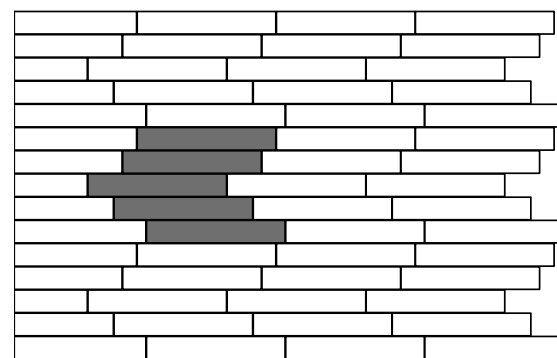

FORMATO SIZE | % Mq.
20x120 . 8"x47" | 100%

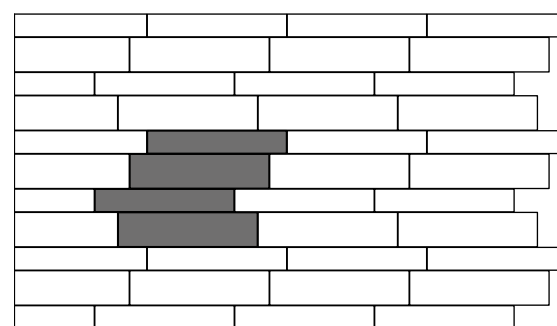

FORMATO SIZE | % Mq.
20x120 . 8"x47" | 40%
30x120 . 12"x47" | 60%

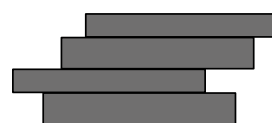
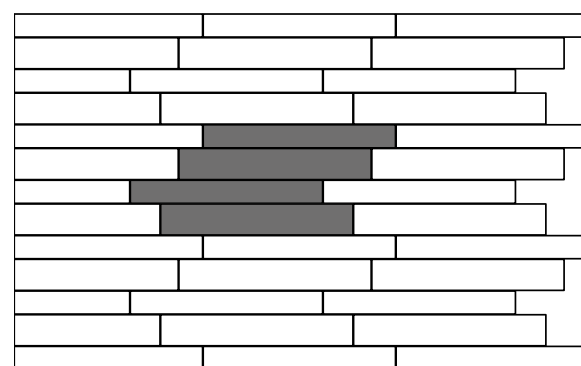

FORMATO SIZE | % Mq.
20x160 . 8"x63" | 42,9%
26,6x160 . 10,5"x63" | 57,1%

POSA CONSIGLIATA CON UNA SFALSATURA TRA CIASCUN LIVELLO NON SUPERIORE A 30 CM E FUGA MINIMA RACCOMANDATA 2 MM. (per il formato 120 cm)
WHEN LAYING YOU ARE RECOMMENDED NOT TO STAGGER THE STRIPS BY MORE THAN ABOUT 30 CM. RECOMMENDED JOINT, MINIMUM 2 MM. (for 120 cm size)

POSA CONSIGLIATA CON UNA SFALSATURA TRA CIASCUN LIVELLO NON SUPERIORE A 40 CM E FUGA MINIMA RACCOMANDATA 2 MM. (per il formato 160 cm)
WHEN LAYING YOU ARE RECOMMENDED NOT TO STAGGER THE STRIPS BY MORE THAN ABOUT 40 CM. RECOMMENDED JOINT, MINIMUM 2 MM. (for 160 cm size)

IMBALLI PACKAGING

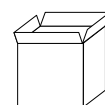

	40x160	26,6x160	20x160	30x120	20x120	MAXI	LINE	40X120 20mm
Pc.	2	3	4	3	4	2	6	2
M ²	1,28	1,27	1,28	1,08	0,96	0,456	1,08	0,96
Kg	30	30	30	22,5	21,60	10	23,76	45

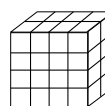

	40x160	26,6x160	20x160	30x120	20x120	40X120 20mm
Colli boxes	36	36	36	48	40	24
Krt./Eur						
M ²	46,08	45,96	46,08	51,84	38,4	23,04
M ² /Eur						
Kg	1120	1120	1120	1080	864	1080
Kg/Eur						

WOODTIME

SCHEDA TECNICA TECHNICAL DATA

Gres fine porcellanato
Fine porcelain stoneware

***** MONOCIBEC ISO 13006Bla EN 14411/G	Caratteristiche tecniche Technical data Caractéristiques techniques Technische daten Características técnicas	Tipo di prova Standard of test Norme du test Testnorm Tipo de prueba	Valore Monocibec Monocibec standards Valeur Monocibec Ergebnis Monocibec Valor de Monocibec
	Dimensioni Sizes Dimensions Abmessungen Dimensiones	ISO 10545.2	A norma According to norm Selon la norme Nach norm Conforme
	Assorbimento d'acqua Water absorption Absorption d'eau Wasseraufnahme Absorción del agua	ISO 10545.3	≤ 0,2%
	Sforzo di rottura Modulus of rupture Effort de rupture Bruchlast Esfuerzo de rotura	ISO 10545.4	S ≥ 1300 N
	Resistenza a flessione Breaking strength Resistance a la flexion Biegefestigkeit Resistencia a la flexión		R ≥ 35 N/mm ²
	Resistenza agli shock termici Resistance to thermal shock Resistance aux chocs thermique Temperaturwechselbeständigkeit Resistencia a los cambios térmicos	ISO 10545.9	Garantita Guaranteed Garantie Garantiert Garantizada
	Resistenza al gelo Frost resistance Resistance au gel Frostbeständigkeit Resistencia a la helada	ISO 10545.12	Garantita Guaranteed Garantie Garantiert Garantizada
	Coefficiente di dilatazione termica lineare Thermal expansion coefficient Coefficient de dilatation thermique lineare Wärmeausdehnungskoeffizient Coeficiente de dilatación termica lineal	ISO 10545.8	A norma According to norm Selon la norme Nach norm Conforme
	Resistenza all'attacco chimico Chemical resistance Resistance chimique Beständigkeit gegen chemischen Resistencia al ataque químico	ISO 10545.13	A norma According to norm Selon la norme Nach norm Conforme
	Resistenza alle macchie Stains resistance Resistance aux taches Fleckenbeständigkeit Resistencia a las manchas	ISO 10545.14	A norma According to norm Selon la norme Nach norm Conforme
	RESISTENZA ALLO SCIVOLAMENTO SLIP RESISTANCE RESISTANCE AU GLISSEMENT RUTSCHFESTIGKEIT RESISTENCIA AL DESLIZAMIENTO	ANSI A 1371-DCOF Coefficiente di attrito dinamico Coefficient of kinetic friction	wet > 0.42
		DIN 51130	R10 nat. R11 grip/major
		DIN 51097	A+B+C grip/mosaico/major A nat.

Escluso pezzi speciali ed elementi decorativi
With the exception of special pieces and decors

Per ulteriori informazioni consultare le schede tecniche dal sito www.monocibec.it
For any further inquiries, refer to the data sheets on the web-site www.monocibec.it

CATEGORIE D'IMPIEGO USE CLASSES

C1 Piastrelle da pavimento consigliate per traffico leggero
Floor tiles recommended for light traffic

C2 Piastrelle da pavimento consigliate per traffico medio-leggero
Floor tiles recommended for medium-light traffic

C3 Piastrelle da pavimento consigliate per traffico medio
Floor tiles recommended for medium traffic

C4 Piastrelle da pavimento consigliate per traffico medio-pesante
Floor tiles recommended for medium-heavy traffic

C5 Piastrelle da pavimento consigliate per impieghi con forti sollecitazioni
Floor tiles recommended for highly stressed uses

VARIAZIONI CROMATICHE COLOUR VARIATIONS

V1 Aspetto uniforme
Even appearance

V2 Lieve variazione
Light variation

V3 Media variazione
Medium variation

V4 Intensa variazione
Strong variation

È indispensabile all'atto della posa, prelevare le piastrelle da più confezioni.
It is necessary to take the tiles from several different boxes when laying them.

Note/Notes

I prodotti possono essere modificati da Fincibec senza preavviso, respingendo ogni responsabilità su possibili danni diretti o indiretti causati da potenziali modifiche.

Fincibec reserves the right to modify its products without prior notice and cannot be held liable for direct or indirect damage caused by such modifications.

Verificare sempre la correttezza delle informazioni e dei dati relativi a codici, imballaggi e pesi, consultando il listino prezzi in vigore.

Always refer to the price list in force to ensure correct information and data on codes, packaging, and weight.

Le tonalità dei colori riportate nel catalogo sono indicative.
The colours shades, reported on the catalogue, are indicative.

ZERO
CO₂
NO EMISSION

WOODTIME
GRES FINE PORCELLANATO

★★★★★
MONOCIBEC®
FINCIBEC GROUP



FINCIBEC S.p.A.
Uffici Comm.li, Stabilimento
e Amministrazione:

via Valle d'Aosta, 47
41049 Sassuolo (MO) Italia
Tel. +39 0536 861.300
Fax Italia +39 0536 861.400
Fax Export + 39 0536 806.974 - 861.450
Fax Uff. Amm. + 39 0536 861.351
www.monocibec.it - info@monocibec.it
www.fincibec.it - info@fincibec.it
GRUPPO FIRE - Fire s.r.l.

